

2A, 24V, 150kHz Step-Down DC-DC Converter

DESCRIPTION

TS2596S Series are step-down switching regulators with all required active functions. It is capable of driving 2A load with excellent line and load regulations. These devices are available in fixed output voltages of 5V, and an adjustable output version. TS2596S series operates at a switching frequency of 150kHz thus allowing smaller sized filter components than what would be needed with lower frequency switching regulators. It substantially not only reduces the area of board size but also the size of heat sink, and in some cases no heat sink is required. The $\pm 4\%$ tolerance on output voltage within specified input voltages and output load conditions is guaranteed. Also, the oscillator frequency accuracy is within $\pm 10\%$. External shutdown is included. Featuring 70 μ A (typical) standby current. The output switch includes cycle-by-cycle current limiting, as well as thermal shutdown for full protection under fault conditions.

FEATURES

- Output Voltage: 5V & Adjustable version
- Adjustable Output Voltage 1.23V~19.5V $\pm 4\%$
- 150kHz $\pm 15\%$ fixed switching frequency
- Voltage Mode Non-synchronous PWM control
- Thermal Shutdown and Current Limit Protection
- ON/OFF Shutdown Control Input
- Soft-Start (SS) Function
- Short Circuit Protect (SCP)
- Operating Voltage Can be up to 24V
- Output Load Current 2A
- Low Power Standby Mode

APPLICATION

- Simple High-efficiency Step down Regulator
- On-Card Switching Regulators



Pin Definition:

- | | |
|--------------|--------|
| 1. Input | 8. GND |
| 2. SW Output | 7. GND |
| 3. Feedback | 6. GND |
| 4. Enable | 5. GND |

Notes: MSL 3 (Moisture Sensitivity Level) per J-STD-020

ABSOLUTE MAXIMUM RATINGS ($T_A = 25^\circ\text{C}$ unless otherwise specified) (Note 1)			
PARAMETER	SYMBOL	LIMIT	UNIT
Supply Voltage	V_{CC}	+28	V
Operating Voltage Range	V_{OP}	+4.5 to +24	V
SW, EN Pin Input Voltage	V_{SW}, V_{EN}	-0.3 to V_{CC}	V
Feedback Pin Voltage	V_{FB}	-0.3 to V_{CC}	V
Power Dissipation	P_D	Internally Limited	W
Output Voltage to Ground	V_{OUT}	-1	V
Storage Temperature Range	T_{ST}	-65 to +150	$^\circ\text{C}$
Operating Temperature Range	T_{OP}	-40 to +125	$^\circ\text{C}$

THERMAL PERFORMANCE (Note 3)			
PARAMETER	SYMBOL	LIMIT	UNIT
Thermal Resistance Junction to Case	$R_{\theta JC}$	15	$^\circ\text{C/W}$
Thermal Resistance Junction to Ambient	$R_{\theta JA}$	70	$^\circ\text{C/W}$

ELECTRICAL SPECIFICATIONS ($T_A = 25^\circ\text{C}$ unless otherwise specified)							
PARAMETER		SYMBOL	CONDITION	MIN	TYP	MAX	UNIT
Output Feedback	ADJ	V_{FB}	$4.5\text{V} \leq V_{IN} \leq 24\text{V}$	1.193	1.23	1.267	V
			$0.2\text{A} \leq I_{LOAD} \leq 2\text{A}$	1.180		1.280	
Efficiency		η	$V_{IN} = 12\text{V}, I_{LOAD} = 2\text{A}$	76	--	--	%
Output Feedback	5V	V_{FB}	$7\text{V} \leq V_{IN} \leq 24\text{V}$	4..80	5	5.20	V
			$0.2\text{A} \leq I_{LOAD} \leq 2\text{A}$	4.75		5.25	
Efficiency		η	$V_{IN} = 12\text{V}, I_{LOAD} = 2\text{A}$	84	--	--	%
Feedback Bias Current		I_{FB}	$V_{FB} = 1.3\text{V}$ (Adj version only)	--	-10	-100	nA
Oscillator Frequency		F_{OSC}		127	150	173	kHz
Soft-Start Time		T_{SS}	Rising edge of EN on to I_{CL}	--	3	--	ms
Current Limit		I_{CL}	Pear Current, no outside circuit $V_{FB} = 0\text{V}$ force driver on	2.4	--	--	A
Oscillator Frequency of Short Circuit Protect		F_{SCP}	When current limit occurred and $V_{FB} < 0.5\text{V}, T_A = 25^\circ\text{C}$	--	60	--	kHz
Saturation Voltage		V_{SAT}	$I_{OUT} = 2\text{A}$, No outside circuit $V_{FB} = 0\text{V}$ force driver on	--	1.15	1.50	V
ON/OFF Pin Logic Input Threshold Voltage		V_{IL}	Low (regulator ON)	--	1.3	0.6	V
		V_{IH}	High (regulator OFF)	2.0		--	
ON/OFF Pin Logic Input Current		I_L	$V_{LOGIC} = 2.5\text{V}$ (OFF)	--	-0.1	-0.5	μA
		I_H	$V_{LOGIC} = 0.5\text{V}$ (ON)	--	--	-0.01	
Maximum Duty Cycle (ON)	DC		$V_{FB} = 0\text{V}$ force driver on	--	100	--	%
Maximum Duty Cycle (OFF)			$V_{FB} = 12\text{V}$ force driver off	--	0	--	
Quiescent Current		I_Q	$V_{FB} = 12\text{V}$ force driver off	--	4	8	mA
Standby Quiescent Current		I_{STBY}	ON/OFF pin=5V	--	45	100	μA
			$V_{IN} = 24\text{V}$	--		100	
SW Pin Leakage Current	SW = 0	I_{SWL}	No outside circuit, $V_{FB} = 12\text{V}$ force driver off	--	--	-200	μA
	SW = -1		$V_{IN} = 24\text{V}$	--	-5	--	mA

Note:

1. Stresses listed as the above "Absolute Maximum Ratings" may cause permanent damage to the device. These are for stress ratings. Functional operation of the device at these or any other conditions beyond those indicated in the operational sections of the specifications is not implied. Exposure to absolute maximum rating conditions for extended periods may remain possibility to affect device reliability.
2. Devices are ESD sensitive. Handling precaution recommended.
3. Thermal Resistance is specified with the component mounted on a low effective thermal conductivity test board in free air at $T_A = 25^\circ\text{C}$.

ORDERING INFORMATION

OUTPUT VOLTAGE	PART NO.	PACKAGE	PACKING
Adjustable	TS2596SCS RLG	SOP-8	2,500pcs / 13"Reel
5V	TS2596SCS50 RLG	SOP-8	2,500pcs / 13"Reel

FUNCTION BLOCK

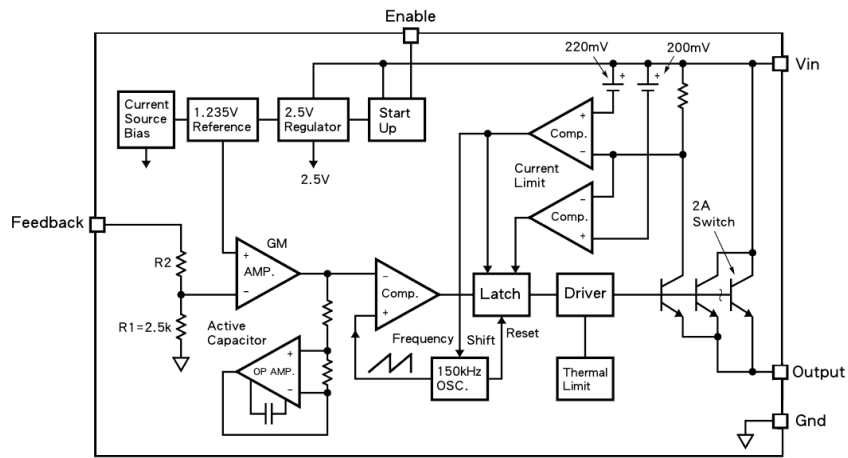

TYPICAL APPLICATION CIRCUIT

Adjustable Output Voltage Version

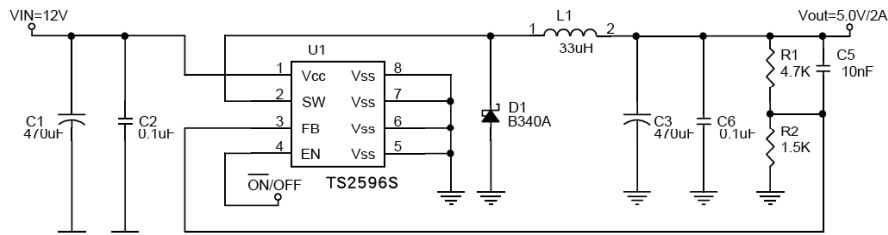

$$V_{out} = V_{FB} \times \left(1 + \frac{R1}{R2}\right)$$

$$V_{FB} = 1.23V$$

$$R2 = 0.47K \sim 2.6K$$

Resistor select for output voltage setting

V _{OUT}	R1	R2
5V	4.7K	1.5K
	5.6K	1.8K
3.3V	2.5K	1.5K
	3.0K	1.8K
2.5V	1.8K	1.8K
1.8V	0.82K	1.8K

Adjustable Output Voltage Version with Delayed Startup

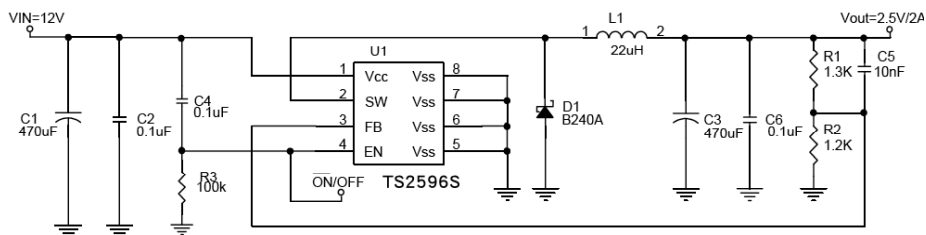

$$V_{out} = V_{FB} \times \left(1 + \frac{R1}{R2}\right)$$

$$V_{FB} = 1.23V$$

$$R2 = 0.47K \sim 2.6K$$

Inverting -5V Regulator with Delayed Startup

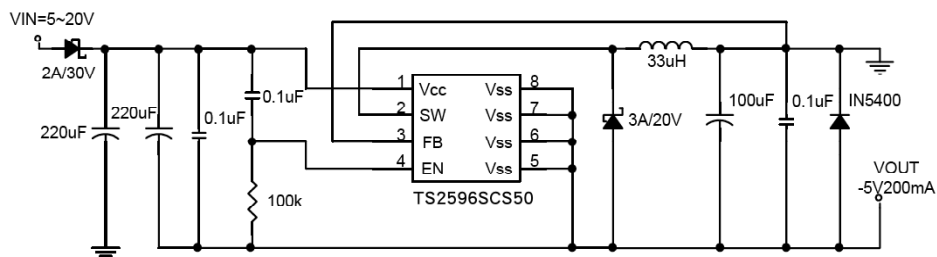

APPLICATION INFORMATION

Pin Function Descriptions

V_{CC}

This is the positive input supply for the IC switching regulator. A suitable input bypass capacitor must be presented at this pin to minimize voltage transients and to supply the switching currents needed by the regulator.

Ground

Circuit ground

SW Output

Internal switch. The voltage at this pin switches between $(+V_{CC} - V_{SAT})$ and approximately $-0.5V$, with a duty cycle of approximately V_{OUT} / V_{CC} . To minimize coupling to sensitive circuitry, the PC board copper area connected to this pin should be minimized.

Feedback

Sense the regulated output voltage to complete the feedback loop.

Enable

Allow the switching regulator circuit to be shutdown using logic level signals, thus dropping the total input supply current to approximately $100\mu A$. Pulling this pin below a threshold voltage of approximately $1.3V$ turns the regulator on, and pulling this pin above $1.3V$ (up to a maximum of V_{CC}) shuts the regulator down. If this shutdown feature is not needed, the EN pin can be wired to the ground pin.

Thermal Considerations

The SOP-8 package needs a heat sink under most conditions. The size of the heat sink depends on the input voltage, the output voltage, the load current and the ambient temperature. The TS2596S junction temperature rises above ambient temperature for a 2A load and different input and output voltages.

The data for these curves was taken with the TS2596S (SOP-8) package operating as a buck-switching regulator in an ambient temperature of $25^{\circ}C$ (still air). These temperature increments are all approximate and are affected by many factors. A higher ambient temperature requires more heat sinker.

For the best thermal performance, wide copper traces and generous amounts of printed circuit board copper (need connect to the Ground pin) should be used in the board layout, (one exception is the SW pin, which should not have large areas of copper.) Large areas of copper provide the best transfer of heat (lower thermal resistance) to the surrounding air, and moving air lowers the thermal resistance even further.

Package thermal resistance and junction temperature increments are all approximate. The increments are affected by a lot of factors. Some of these factors include board size, shape, thickness, position, location, and even board temperature. Other factors are, trace width, total printed circuit copper area, copper thickness, single or double-sided, multi-layer board and the amount of solder on the board.

The effectiveness of the PC board to dissipate heat also depends on the size, quantity and spacing of other components on the board, as well as whether the surrounding air is still or moving. Furthermore, some of these components such as the catch diode will add heat to the PC board and the heat can vary as the input voltage changes. For the inductor, depending on the physical size, type of core material and the DC resistance, it could either act as a heat sink taking heat away from the board, or it could add heat to the board.

CHARACTERISTICS CURVES

($T_c = 25^\circ\text{C}$ unless otherwise noted)

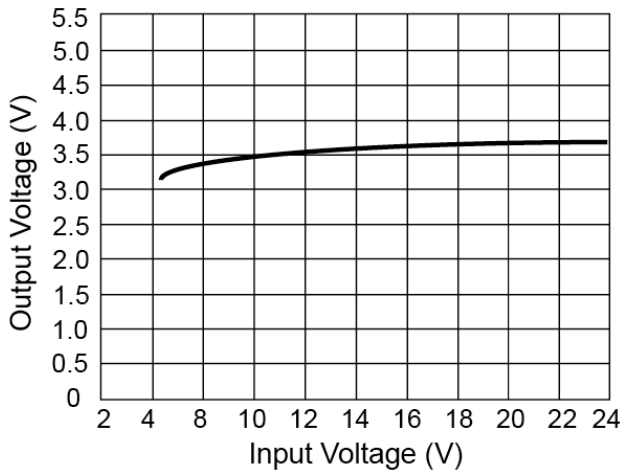

Figure 1 – V_{OUT} vs. V_{IN}

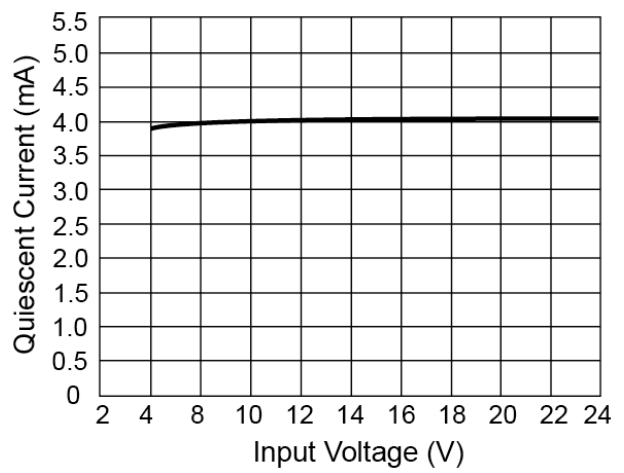

Figure 2 – Quiescent Current vs. V_{IN}

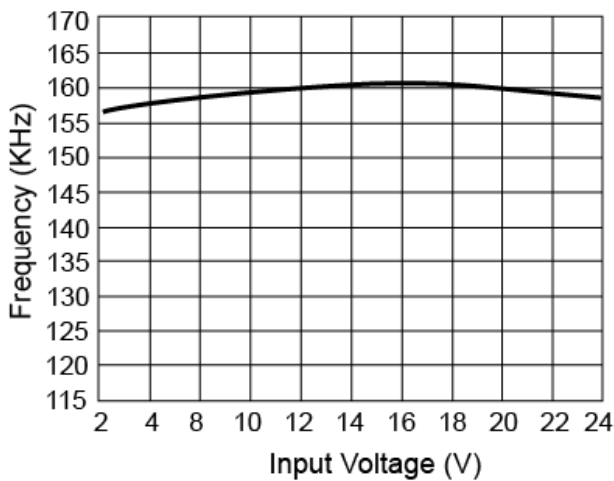

Figure 3 – Frequency vs. V_{IN}

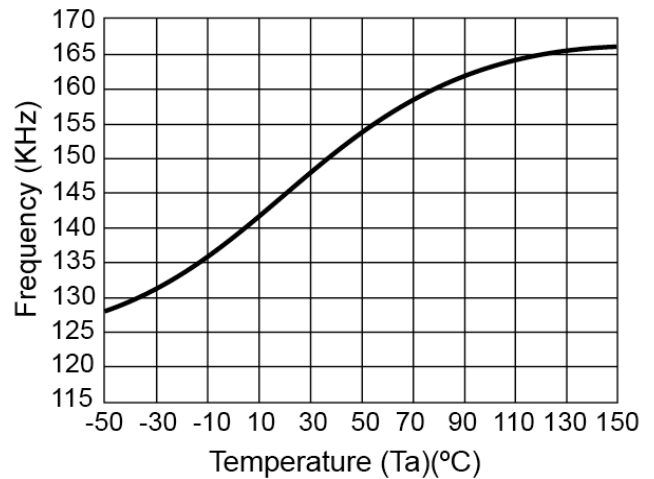

Figure 4 – Frequency vs. Temperature

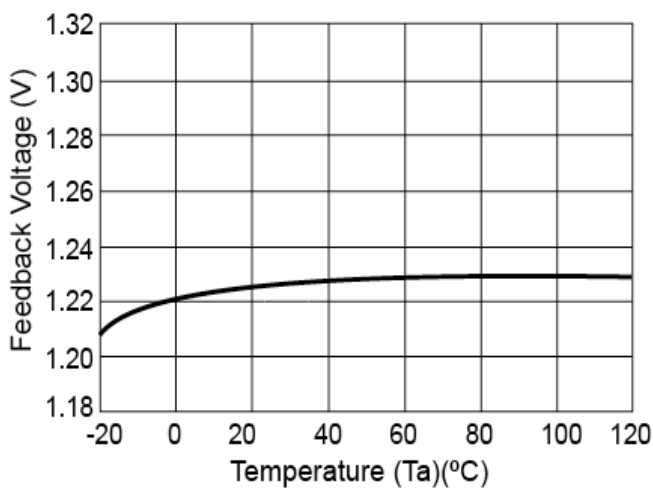

Figure 5 – Feedback Voltage vs. Temperature

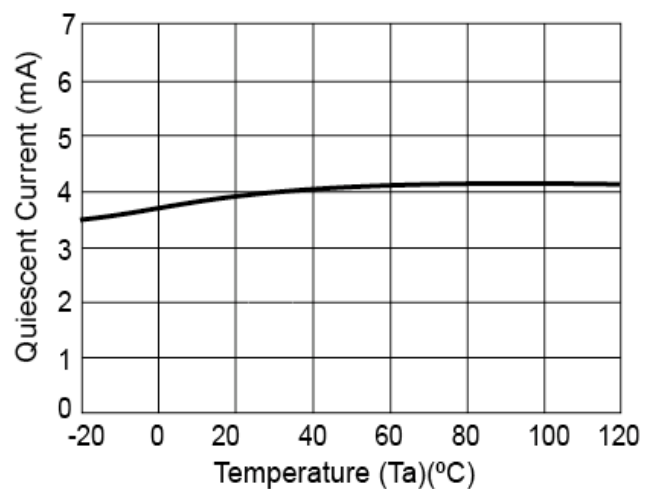

Figure 6 – Quiescent Current vs. Temperature

CHARACTERISTICS CURVES

($T_C = 25^\circ\text{C}$ unless otherwise noted)

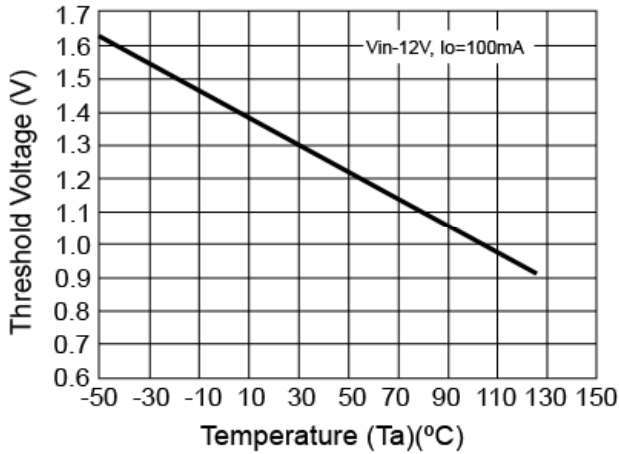

Figure 7 – Threshold Voltage vs. Temperature

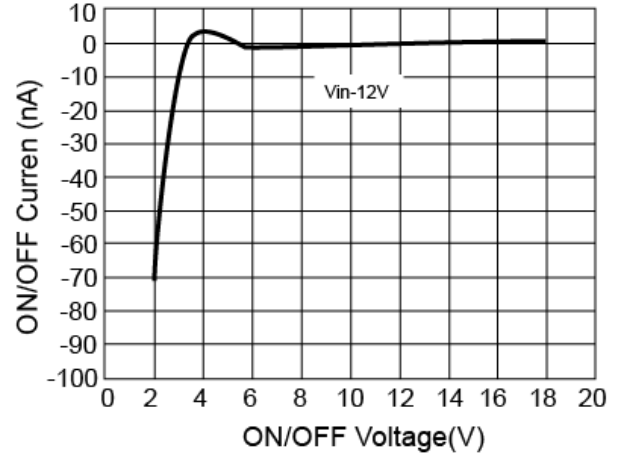

Figure 8 – ON/OFF Current vs. Voltage

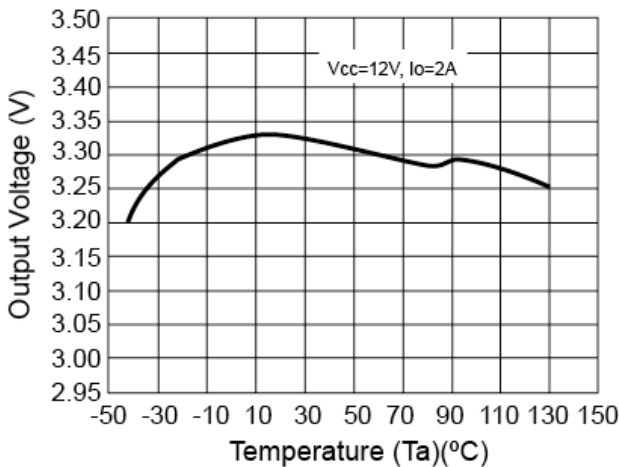

Figure 9 – Output Voltage vs. Temperature

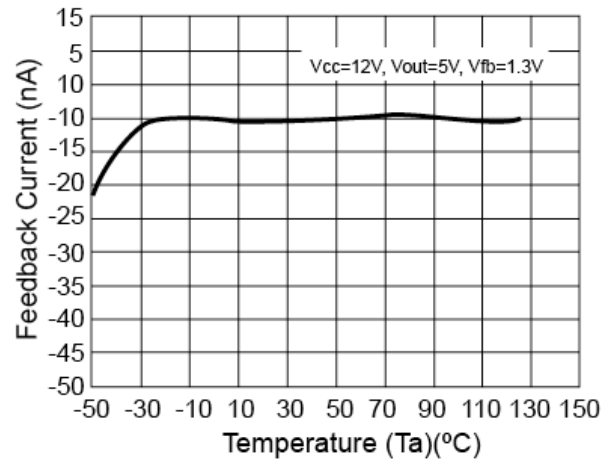

Figure 10 – Feedback Current vs. Temperature

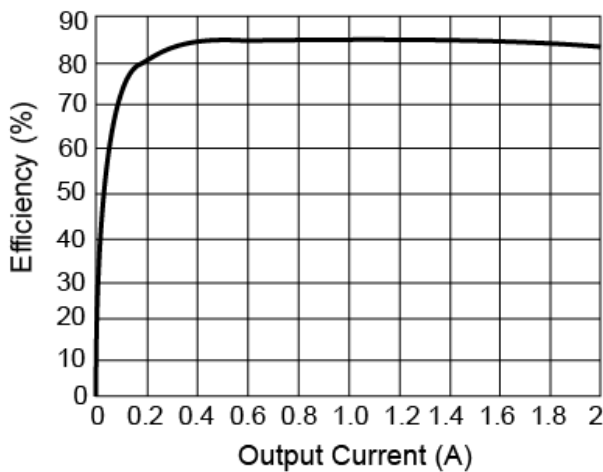

Figure 11 – Efficiency ($V_{IN}=12\text{V}$, $V_{OUT}=3.3\text{V}$)

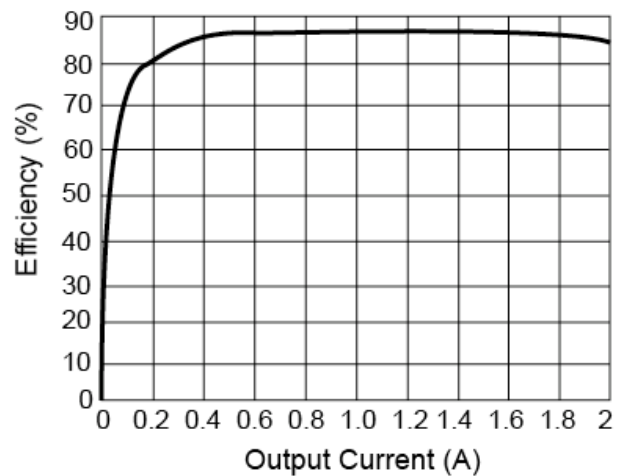
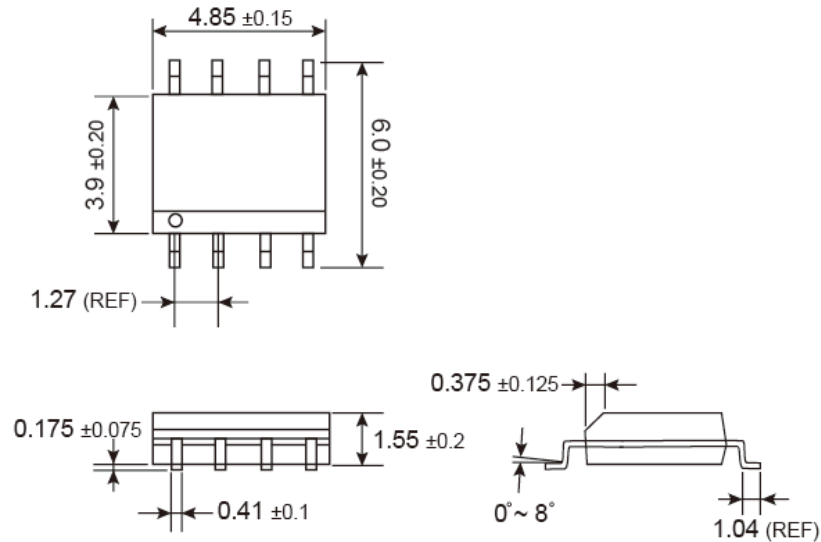

Figure 12 – Efficiency ($V_{IN}=12\text{V}$, $V_{OUT}=5\text{V}$)

PACKAGE OUTLINE DIMENSIONS (Unit: Millimeters)

SOP-8



SUGGESTED PAD LAYOUT (Unit: Millimeters)

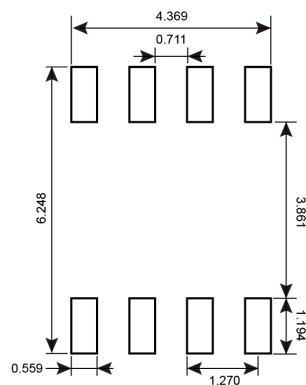

MARKING DIAGRAM

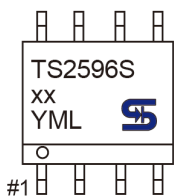

- XX** = Output Voltage
 - 50** =5.0V
 - Blank** = Adjustable
- Y** = Year Code
- M** = Month Code for Halogen Free Product
 - O** =Jan **P** =Feb **Q** =Mar **R** =Apr
 - S** =May **T** =Jun **U** =Jul **V** =Aug
 - W** =Sep **X** =Oct **Y** =Nov **Z** =Dec
- L** = Lot Code

Notice

Specifications of the products displayed herein are subject to change without notice. TSC or anyone on its behalf, assumes no responsibility or liability for any errors or inaccuracies.

Information contained herein is intended to provide a product description only. No license, express or implied, to any intellectual property rights is granted by this document. Except as provided in TSC's terms and conditions of sale for such products, TSC assumes no liability whatsoever, and disclaims any express or implied warranty, relating to sale and/or use of TSC products including liability or warranties relating to fitness for a particular purpose, merchantability, or infringement of any patent, copyright, or other intellectual property right.

The products shown herein are not designed for use in medical, life-saving, or life-sustaining applications. Customers using or selling these products for use in such applications do so at their own risk and agree to fully indemnify TSC for any damages resulting from such improper use or sale.

Компания «Океан Электроники» предлагает заключение долгосрочных отношений при поставках импортных электронных компонентов на взаимовыгодных условиях!

Наши преимущества:

- Поставка оригинальных импортных электронных компонентов напрямую с производств Америки, Европы и Азии, а так же с крупнейших складов мира;
- Широкая линейка поставок активных и пассивных импортных электронных компонентов (более 30 млн. наименований);
- Поставка сложных, дефицитных, либо снятых с производства позиций;
- Оперативные сроки поставки под заказ (от 5 рабочих дней);
- Экспресс доставка в любую точку России;
- Помощь Конструкторского Отдела и консультации квалифицированных инженеров;
- Техническая поддержка проекта, помощь в подборе аналогов, поставка прототипов;
- Поставка электронных компонентов под контролем ВП;
- Система менеджмента качества сертифицирована по Международному стандарту ISO 9001;
- При необходимости вся продукция военного и аэрокосмического назначения проходит испытания и сертификацию в лаборатории (по согласованию с заказчиком);
- Поставка специализированных компонентов военного и аэрокосмического уровня качества (Xilinx, Altera, Analog Devices, Intersil, Interpoint, Microsemi, Actel, Aeroflex, Peregrine, VPT, Syfer, Eurofarad, Texas Instruments, MS Kennedy, Miteq, Cobham, E2V, MA-COM, Hittite, Mini-Circuits, General Dynamics и др.);

Компания «Океан Электроники» является официальным дистрибьютором и эксклюзивным представителем в России одного из крупнейших производителей разъемов военного и аэрокосмического назначения «JONHON», а так же официальным дистрибьютором и эксклюзивным представителем в России производителя высокотехнологичных и надежных решений для передачи СВЧ сигналов «FORSTAR».



JONHON

«JONHON» (основан в 1970 г.)

Разъемы специального, военного и аэрокосмического назначения:

(Применяются в военной, авиационной, аэрокосмической, морской, железнодорожной, горно- и нефтедобывающей отраслях промышленности)

«FORSTAR» (основан в 1998 г.)

ВЧ соединители, коаксиальные кабели, кабельные сборки и микроволновые компоненты:

(Применяются в телекоммуникациях гражданского и специального назначения, в средствах связи, РЛС, а так же военной, авиационной и аэрокосмической отраслях промышленности).



Телефон: 8 (812) 309-75-97 (многоканальный)

Факс: 8 (812) 320-03-32

Электронная почта: ocean@oceanchips.ru

Web: <http://oceanchips.ru/>

Адрес: 198099, г. Санкт-Петербург, ул. Калинина, д. 2, корп. 4, лит. А