



Phototriac coupler ideal for triac driver with wide variation

APT Phototriac Coupler



RoHS compliant

FEATURES

1. Low zero-cross voltage (max. 15 V) type added to lineup. Approximately 1/3 of previous product

Helps reduce device noises even further.

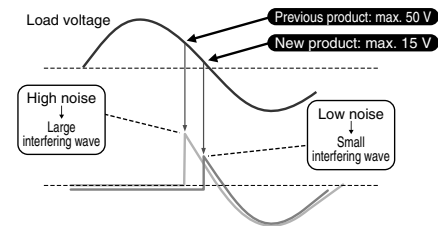

- 2. Two types available: Random type and zero-cross type**
- 3. Many package sizes available. (Wide terminal type with 10.16 mm pitch between I/O terminals available.)**
- 4. High dielectric strength. (Between input and output: SOP 3, 750 V; DIP 5,000 V)**
- 5. Handles both 100 and 200 Vrms loads**

This relay handles both voltages in a single product it is not necessary for users that use both types to manage separate part numbers.

6. Terminal 5 of the DIP 6-pin type is completely molded.

7. Complies with safety standards

SOP4pin:

- C-UL (UL1577) Certified
- VDE (EN60747-5-5) Certified

DIP4/6pin:

- C-UL (UL1577) Certified
- VDE (EN60747-5-5) Certified
- VDE (EN62368-1) Reinforced insulation certified

TYPICAL APPLICATIONS

- 1. For triac driver in heater controls of products such as office equipment, home appliances, and industrial machines. (For 100 V/200 V, 50/60 Hz lines)**
- 2. Triac driver for SSRs**

ORDERING INFORMATION

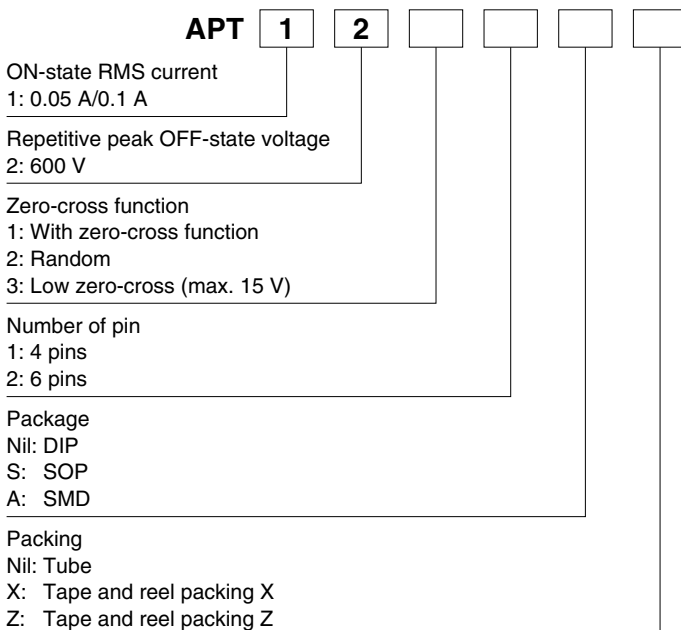

TYPES

1. SOP4 Type

Type	Output rating		Type	Package size	Part No.			Packing quantity	
	Repetitive peak OFF-state voltage	ON-state RMS current			Tube packing style	Tape and reel packing style		Tube	Tape and reel
						Picked from the 1/2-pin side	Picked from the 3/4-pin side		
AC type	600 V	50 mA	Zero-cross (max. 50 V)	SOP4pin	APT1211S	APT1211SX	APT1211SZ	1 tube contains: 100 pcs. 1 batch contains: 2,000 pcs.	1,000 pcs.
			Zero-cross (max. 15 V)		APT1231S	APT1231SX	APT1231SZ		
			Random		APT1221S	APT1221SX	APT1221SZ		

Note: For space reasons, the initial letters of the product number "APT" and "S" are omitted on the product seal.
The package type indicator "X" and "Z" are omitted from the seal. (Ex. the label for product number APT1221SZ is 1221).

2. DIP4/6 Type

Type	Output rating		Type	Package size	Part No.				Packing quantity	
	Repetitive peak OFF-state voltage	ON-state RMS current			Through hole terminal	Surface-mount terminal		Tube	Tape and reel	
						Tape and reel packing style				
				Tube packing style	Picked from the 1/2-pin side 1/2/3-pin side	Picked from the 3/4-pin side 4/6-pin side				
AC type	600 V	100 mA	Zero-cross (max. 50 V)	DIP4pin	APT1211	APT1211A	APT1211AX	APT1211AZ	[DIP4pin] 1 tube contains: 100 pcs. 1 batch contains: 1,000 pcs.	[DIP4pin] [DIP6pin] 1,000 pcs.
			Zero-cross (max. 15 V)		APT1231	APT1231A	APT1231AX	APT1231AZ		
			Random		APT1221	APT1221A	APT1221AX	APT1221AZ		
			Zero-cross (max. 50 V)	DIP6pin	APT1212	APT1212A	APT1212AX	APT1212AZ	[DIP6pin] 1 tube contains: 50 pcs. 1 batch contains: 500 pcs.	
			Zero-cross (max. 15 V)		APT1232	APT1232A	APT1232AX	APT1232AZ		
			Random		APT1222	APT1222A	APT1222AX	APT1222AZ		

Note: For space reasons the initial letters "APT" of the product number for the DIP 4-pin type, the letter "A", which indicates the SMD terminal shape for the DIP 4-pin and 6-pin types, and the package type indications "X" and "Z" have been omitted from the product label. (Example: The label for product number APT1221AZ is 1221.)

3. DIP6 Wide Terminal Type

Type	Output rating*		Type	Package size	Part No.				Packing quantity	
	Repetitive peak OFF-state voltage	ON-state RMS current			Through hole terminal	Surface-mount terminal		Tube	Tape and reel	
						Tape and reel packing style				
				Tube packing style	Picked from the 1/6-pin side	Picked from the 3/4-pin side				
AC type	600 V	100 mA	Zero-cross (max. 50 V)	DIP6pin	APT1212W	APT1212WA	APT1212WAY	APT1212WAW	1 tube contains: 50 pcs. 1 batch contains: 500 pcs.	1,000 pcs.
			Zero-cross (max. 15 V)		APT1232W	APT1232WA	APT1232WAY	APT1232WAW		
			Random		APT1222W	APT1222WA	APT1222WAY	APT1222WAW		

Note: For space reasons the initial letters the letter "WA", which indicates the SMD terminal shape for the DIP 6-pin types, and the package type indications "Y" and "W" have been omitted from the product label. (Example: The label for product number APT1212WAY is 1212.)

RATING

1. Absolute maximum ratings (Ambient temperature: 25°C 77°F)

1) SOP4 types

Item		Symbol	APT1211S, APT1221S, APT1231S	Remarks
Input	LED forward current	I_F	50 mA	
	LED reverse voltage	V_R	6 V	
	Peak forward current	I_{FP}	1 A	f = 100 Hz, Duty Ratio = 0.1%
Output	Repetitive peak OFF-state voltage	V_{DRM}	600 V	
	ON-state RMS current*	$I_{T(RMS)}$	0.05 A	AC
	Non-repetitive surge current	I_{TSM}	0.6 A	In one cycle at 60 Hz
Total power dissipation		P_T	350 mW	
I/O isolation voltage		V_{iso}	3,750 Vrms	
Temperature limits	Operating	T_{opr}	-40 to +100°C -40 to +212°F	Non-condensing at low temperatures
	Storage	T_{stg}	-40 to +125°C -40 to +257°F	

Note: "X" and "Z" at the end of the part numbers have been omitted.

2) DIP4/6 type and DIP6 Wide terminal type

Item		Symbol	APT1211, APT1221, APT1231, APT1212(W), APT1222(W), APT1232(W)	Remarks
Input	LED forward current	I_F	50 mA	
	LED reverse voltage	V_R	6 V	
	Peak forward current	I_{FP}	1 A	f = 100 Hz, Duty Ratio = 0.1%
Output	Repetitive peak OFF-state voltage	V_{DRM}	600 V	
	ON-state RMS current*	$I_{T(RMS)}$	0.1 A	AC
	Non-repetitive surge current	I_{TSM}	1.2 A	In one cycle at 60 Hz
Total power dissipation		P_T	500 mW	
I/O isolation voltage		V_{iso}	5,000 Vrms	
Temperature limits	Operating	T_{opr}	-40 to +100°C -40 to +212°F	Non-condensing at low temperatures
	Storage	T_{stg}	-40 to +125°C -40 to +257°F	

Note: "A", "AX", "AZ" "AY" and "AW" at the end of the part numbers have been omitted.

* Do not exceed 0.05 A of ON state RMS current in case of following load voltage condition.

DIP4pin (APT1211, APT1221, APT1231): more than 100 Vrms;

DIP6pin (APT1212, APT1222, APT1232) and DIP6pin wide terminal type (APT1212W, APT1222W, APT1232W): more than 120 Vrms.

2. Characteristics (Ambient temperature: 25°C 77°F)

1) Zero-cross type (max. 50 V) and random type

Item		Symbol	APT1211S, APT1211, APT1212(W)	APT1221S, APT1221, APT1222(W)	Condition
Input	LED dropout voltage	Typical	1.21 V		$I_F = 20 \text{ mA}$
		Maximum	1.3 V		
	LED reverse current	Typical	—		$V_R = 6 \text{ V}$
		Maximum	10 μA		
Output	Repetitive peak OFF-state current	Typical	—		$I_F = 0 \text{ mA}$ $V_{DRM} = 600 \text{ V}$
		Maximum	1 μA		
	Repetitive peak On-state voltage	Typical	1.3 V		$I_F = 10 \text{ mA}$ $I_{TM} = 0.05 \text{ A}$
		Maximum	2.5 V		
Holding current	Typical	0.3 mA			
	Maximum	3.5 mA			
Critical rate of rise of OFF-state voltage	Minimum	dv/dt	500 V/ μs		$V_{DRM} = 600 \text{ V} \times 1/\sqrt{2}$
Transfer characteristics	Trigger LED current	Maximum	I_{FT}	10 mA	$V_D = 6 \text{ V}$ $R_L = 100 \Omega$
	Zero-cross voltage	Maximum	V_{ZC}	50 V	$I_F = 10 \text{ mA}$
	Turn on time*	Maximum	T_{on}	100 μs	$I_F = 20 \text{ mA}$ $V_D = 6 \text{ V}$ $R_L = 100 \Omega$
	I/O capacitance	Maximum	C_{iso}	1.5 pF	$f = 1 \text{ MHz}$ $V_B = 0 \text{ V}$
	I/O isolation resistance	Minimum	R_{iso}	50 G Ω	500 V DC

Note: 1. For type of connection, see "SCHEMATIC AND WIRING DIAGRAMS".

*Turn on time



2) Zero-cross type (max. 15 V)

Item		Symbol	APT1231S, APT1231, APT1232(W)		Condition
Input	LED dropout voltage	Typical	1.21 V		$I_F = 20 \text{ mA}$
		Maximum	1.3 V		
	LED reverse current	Typical	—		$V_R = 6 \text{ V}$
		Maximum	10 μA		
Output	Repetitive peak OFF-state current	Typical	—		$I_F = 0 \text{ mA}$ $V_{DRM} = 600 \text{ V}$
		Maximum	1 μA		
	Repetitive peak On-state voltage	Typical	1.2 V		$I_F = 10 \text{ mA}$ $I_{TM} = 0.03 \text{ A}$
		Maximum	2 V		
Holding current	Typical	0.3 mA			
	Maximum	3.5 mA			
Critical rate of rise of OFF-state voltage	Minimum	dv/dt	500 V/ μs		$V_{DRM} = 600 \text{ V} \times 1/\sqrt{2}$
Transfer characteristics	Trigger LED current	Maximum	I_{FT}	10 mA	$I_{TM} = 0.03 \text{ A}$
	Zero-cross voltage	Maximum	V_{ZC}	15 V	$I_F = 10 \text{ mA}$
	Turn on time*	Maximum	T_{on}	100 μs	$I_F = 20 \text{ mA}$ $I_{TM} = 0.03 \text{ A}$
	I/O capacitance	Maximum	C_{iso}	1.5 pF	$f = 1 \text{ MHz}$ $V_B = 0 \text{ V}$
	I/O isolation resistance	Minimum	R_{iso}	50 G Ω	500 V DC

Note: 1. For type of connection, see "SCHEMATIC AND WIRING DIAGRAMS".

*Turn on time

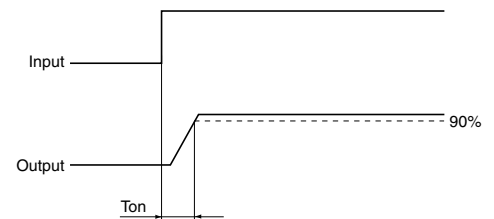

RECOMMENDED OPERATING CONDITIONS

Please use under recommended operating conditions to obtain expected characteristics.

Item	Symbol	Min.	Max.	Unit
Input LED current	I_F	15	25	mA

REFERENCE DATA

1-(1). ON-state RMS current vs. ambient temperature characteristics

Allowable ambient temperature: -40 to +100°C
-40 to +212°F

Tested sample: APT1211S, APT1221S



1-(2). ON-state RMS current vs. ambient temperature characteristics

Allowable ambient temperature: -40 to +100°C
-40 to +212°F

Tested sample: APT1231S



1-(3). ON-state RMS current vs. ambient temperature characteristics

Allowable ambient temperature: -40 to +100°C
-40 to +212°F

Tested sample: APT1211(A), APT1221(A)



1-(4). ON-state RMS current vs. ambient temperature characteristics

Allowable ambient temperature: -40 to +100°C
-40 to +212°F

Tested sample: APT1231(A)



1-(5). ON-state RMS current vs. ambient temperature characteristics

Allowable ambient temperature: -40 to +100°C
-40 to +212°F

Tested sample: APT1212(A), APT1222(A),
APT1212W(A), APT1222W(A)



1-(6). ON-state RMS current vs. ambient temperature characteristics

Allowable ambient temperature: -40 to +100°C
-40 to +212°F

Tested sample: APT1232(A), APT1232W(A)



2. On voltage vs. ambient temperature characteristics



3. Trigger LED current vs. ambient temperature characteristics



4. LED dropout voltage vs. ambient temperature characteristics



5. Turn on time vs. LED current characteristics



6. Repetitive peak OFF-state current vs. Load voltage characteristics



7. Hold current vs. ambient temperature characteristics



8. Zero-cross voltage vs. ambient temperature characteristics



DIMENSIONS (mm inch)

The CAD data of the products with a **CAD** mark can be downloaded from: <https://industrial.panasonic.com/ac/e/>

1. SOP Type

APT1211S, APT1221S, APT1231S

CAD



External dimensions



Recommended mounting pad (TOP VIEW)



Tolerance: $\pm 0.1 \pm .004$

Terminal thickness = $0.15 \pm .006$

General tolerance: $\pm 0.1 \pm .004$

2. DIP4 Type

APT1211(A), APT1221(A), APT1231(A)

CAD



External dimensions

Through hole terminal type

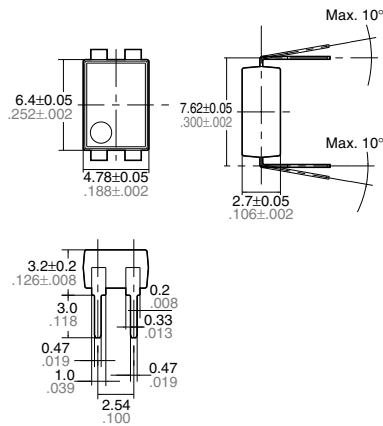

Surface mount terminal type



Terminal thickness = $0.20 \pm .008$

General tolerance: $\pm 0.1 \pm .004$

PC board pattern (BOTTOM VIEW)



Tolerance: $\pm 0.1 \pm .004$

Recommended mounting pad (TOP VIEW)

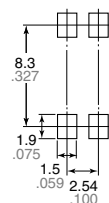

Tolerance: $\pm 0.1 \pm .004$

3. DIP6 Type

APT1212(A), APT1222(A), APT1232(A)

CAD



External dimensions

Through hole terminal type



Surface mount terminal type



Terminal thickness = 0.25 ± 0.10
General tolerance: $\pm 0.1 \pm 0.04$

PC board pattern (BOTTOM VIEW)



Tolerance: $\pm 0.1 \pm 0.04$

Recommended mounting pad (TOP VIEW)

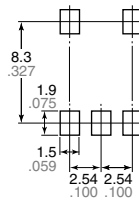

Tolerance: $\pm 0.1 \pm 0.04$

4. DIP6 Wide Terminal Type

APT1212W(A), APT1222W(A), APT1232W(A)

CAD

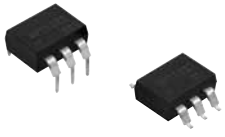

External dimensions

Through hole terminal type



Surface mount terminal type

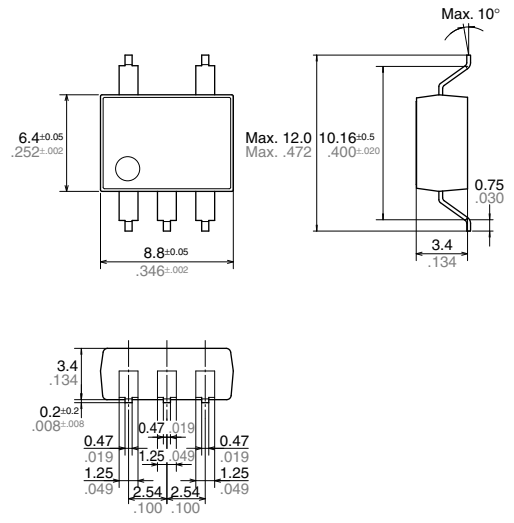

Terminal thickness = 0.25 .010
General tolerance: ±0.1 ±.004

PC board pattern (BOTTOM VIEW)

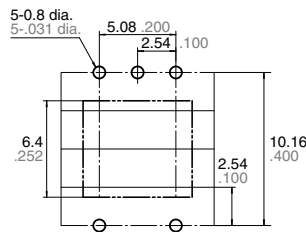

Recommended mounting pad (TOP VIEW)

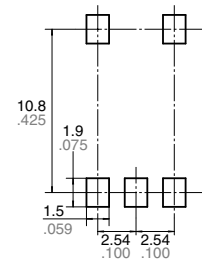

Tolerance: ±0.1 ±.004

Tolerance: ±0.1 ±.004

SCHEMATIC AND WIRING DIAGRAMS

Schematic	Output configuration	Load	Wiring diagram
<p>Zero-cross circuit</p>	1 Form A	AC	<p>Power source at input side</p>
			<p>Power source at input side</p>
<p>Zero-cross circuit</p>			<p>Power source at input side</p>
			<p>Power source at input side</p>

Please contact

Panasonic Corporation

Electromechanical Control Business Division

■ 1006, Oaza Kadoma, Kadoma-shi, Osaka 571-8506, Japan
industrial.panasonic.com/ac/e/

Panasonic[®]

©Panasonic Corporation 2018

Mouser Electronics

Authorized Distributor

Click to View Pricing, Inventory, Delivery & Lifecycle Information:

Panasonic:

[APT1211](#) [APT1211AX](#) [APT1211AZ](#) [APT1211SX](#) [APT1211SZ](#) [APT1211W](#) [APT1211WA](#) [APT1211WAW](#)
[APT1211WAY](#) [APT1212A](#) [APT1212AX](#) [APT1212AZ](#) [APT1212W](#) [APT1212WA](#) [APT1212WAW](#) [APT1212WAY](#)
[APT1221AX](#) [APT1221AZ](#) [APT1221SX](#) [APT1221SZ](#) [APT1221W](#) [APT1221WA](#) [APT1221WAW](#) [APT1221WAY](#)
[APT1222A](#) [APT1222AX](#) [APT1222AZ](#) [APT1222W](#) [APT1222WA](#) [APT1222WAW](#) [APT1222WAY](#) [APT1232A](#)
[APT1212D05](#) [APT1222D05](#)

Компания «Океан Электроники» предлагает заключение долгосрочных отношений при поставках импортных электронных компонентов на взаимовыгодных условиях!

Наши преимущества:

- Поставка оригинальных импортных электронных компонентов напрямую с производств Америки, Европы и Азии, а так же с крупнейших складов мира;
- Широкая линейка поставок активных и пассивных импортных электронных компонентов (более 30 млн. наименований);
- Поставка сложных, дефицитных, либо снятых с производства позиций;
- Оперативные сроки поставки под заказ (от 5 рабочих дней);
- Экспресс доставка в любую точку России;
- Помощь Конструкторского Отдела и консультации квалифицированных инженеров;
- Техническая поддержка проекта, помощь в подборе аналогов, поставка прототипов;
- Поставка электронных компонентов под контролем ВП;
- Система менеджмента качества сертифицирована по Международному стандарту ISO 9001;
- При необходимости вся продукция военного и аэрокосмического назначения проходит испытания и сертификацию в лаборатории (по согласованию с заказчиком);
- Поставка специализированных компонентов военного и аэрокосмического уровня качества (Xilinx, Altera, Analog Devices, Intersil, Interpoint, Microsemi, Actel, Aeroflex, Peregrine, VPT, Syfer, Eurofarad, Texas Instruments, MS Kennedy, Miteq, Cobham, E2V, MA-COM, Hittite, Mini-Circuits, General Dynamics и др.);

Компания «Океан Электроники» является официальным дистрибьютором и эксклюзивным представителем в России одного из крупнейших производителей разъемов военного и аэрокосмического назначения «JONHON», а так же официальным дистрибьютором и эксклюзивным представителем в России производителя высокотехнологичных и надежных решений для передачи СВЧ сигналов «FORSTAR».



JONHON

«JONHON» (основан в 1970 г.)

Разъемы специального, военного и аэрокосмического назначения:

(Применяются в военной, авиационной, аэрокосмической, морской, железнодорожной, горно- и нефтедобывающей отраслях промышленности)

«FORSTAR» (основан в 1998 г.)

ВЧ соединители, коаксиальные кабели,
кабельные сборки и микроволновые компоненты:

(Применяются в телекоммуникациях гражданского и специального назначения, в средствах связи, РЛС, а так же военной, авиационной и аэрокосмической отраслях промышленности).



Телефон: 8 (812) 309-75-97 (многоканальный)

Факс: 8 (812) 320-03-32

Электронная почта: ocean@oceanchips.ru

Web: <http://oceanchips.ru/>

Адрес: 198099, г. Санкт-Петербург, ул. Калинина, д. 2, корп. 4, лит. А