

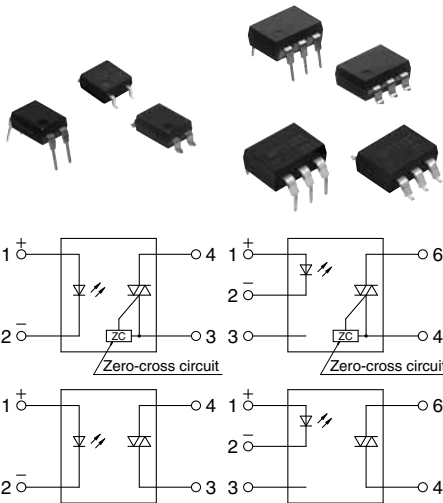

### Phototriac coupler ideal for triac driver with wide variation

### APT Phototriac Coupler



RoHS compliant

### FEATURES

- Low zero-cross voltage (max. 15 V) type added to lineup. Approximately 1/3 of previous product**  
Helps reduce device noises even further.
- Two types available: Random type and zero-cross type**
- Many package sizes available.** (Wide terminal type with 10.16 mm pitch between I/O terminals available.)
- High dielectric strength.** (Between input and output: SOP 3, 750 V; DIP 5,000 V)
- Handles both 100 and 200 Vrms loads**  
This relay handles both voltages in a single product it is not necessary for users that use both types to manage separate part numbers.

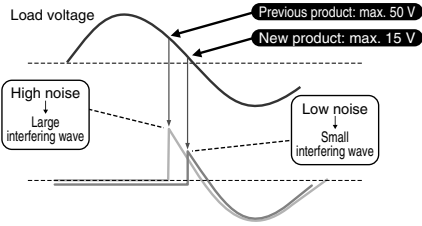

- Terminal 5 of the DIP 6-pin type is completely molded.**
- Complies with safety standards**  
SOP4pin:  
C-UL (UL1577) Certified  
VDE (EN60747-5-5) Certified  
DIP4/6pin:  
C-UL (UL1577) Certified  
VDE (EN60747-5-5) Certified  
VDE (EN62368-1) Reinforced insulation certified

### TYPICAL APPLICATIONS

- For triac driver in heater controls of products such as office equipment, home appliances, and industrial machines. (For 100 V/200 V, 50/60 Hz lines)
- Triac driver for SSRs

### ORDERING INFORMATION

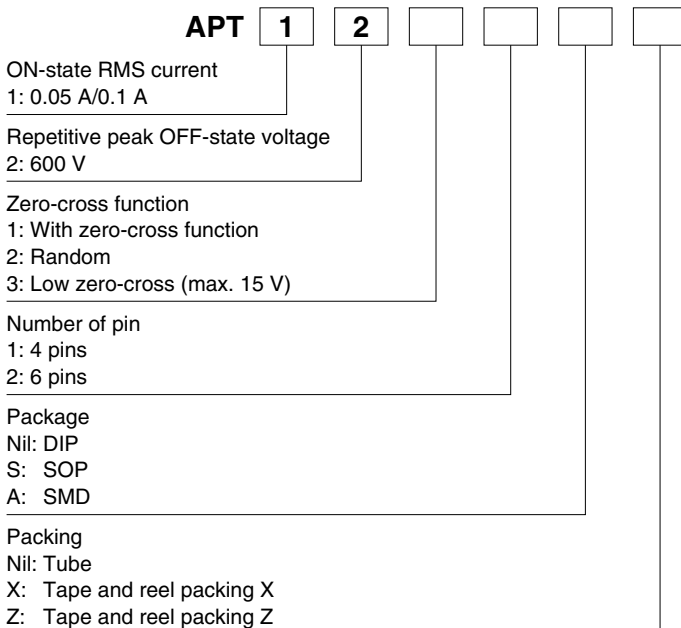

# TYPES

## 1. SOP4 Type

| Type    | Output rating                     |                      | Type                   | Package size | Part No.           |                              |                              | Packing quantity  |               |
|---------|-----------------------------------|----------------------|------------------------|--------------|--------------------|------------------------------|------------------------------|---|---------------|
|         | Repetitive peak OFF-state voltage | ON-state RMS current |                        |              | Tube packing style | Tape and reel packing style  |                              | Tube  | Tape and reel |
|         |                                   |                      |                        |              |                    | Picked from the 1/2-pin side | Picked from the 3/4-pin side |   |               |
| AC type | 600 V                             | 50 mA                | Zero-cross (max. 50 V) | SOP4pin      | APT1211S           | APT1211SX                    | APT1211SZ                    | 1 tube contains: 100 pcs.<br>1 batch contains: 2,000 pcs. | 1,000 pcs.    |
|         |                                   |                      | Zero-cross (max. 15 V) |              | APT1231S           | APT1231SX                    | APT1231SZ                    |   |               |
|         |                                   |                      | Random                 |              | APT1221S           | APT1221SX                    | APT1221SZ                    |   |               |

Note: For space reasons, the initial letters of the product number "APT" and "S" are omitted on the product seal. The package type indicator "X" and "Z" are omitted from the seal. (Ex. the label for product number APT1221SZ is 1221).

## 2. DIP4/6 Type

| Type    | Output rating                     |                      | Type                   | Package size | Part No.              |  |  |           | Packing quantity   |                                      |
|---------|-----------------------------------|----------------------|------------------------|--------------|-----------------------|--|--|-----------|--|--------------------------------------|
|         | Repetitive peak OFF-state voltage | ON-state RMS current |                        |              | Through hole terminal | Surface-mount terminal                         |  | Tube      | Tape and reel  |                                      |
|         |                                   |                      |                        |              |                       | Tube packing style                             | Tape and reel packing style                  |           |  |                                      |
|         |                                   |                      |                        |              |                       | Picked from the 1/2-pin side<br>1/2/3-pin side | Picked from the 3/4-pin side<br>4/6-pin side |           |  |                                      |
| AC type | 600 V                             | 100 mA               | Zero-cross (max. 50 V) | DIP4pin      | APT1211               | APT1211A                                       | APT1211AX                                    | APT1211AZ | [DIP4pin]<br>1 tube contains: 100 pcs.<br>1 batch contains: 1,000 pcs. | [DIP4pin]<br>[DIP6pin]<br>1,000 pcs. |
|         |                                   |                      | Zero-cross (max. 15 V) |              | APT1231               | APT1231A                                       | APT1231AX                                    | APT1231AZ |  |                                      |
|         |                                   |                      | Random                 |              | APT1221               | APT1221A                                       | APT1221AX                                    | APT1221AZ |  |                                      |
|         |                                   |                      | Zero-cross (max. 50 V) | DIP6pin      | APT1212               | APT1212A                                       | APT1212AX                                    | APT1212AZ | [DIP6pin]<br>1 tube contains: 50 pcs.<br>1 batch contains: 500 pcs.    |                                      |
|         |                                   |                      | Zero-cross (max. 15 V) |              | APT1232               | APT1232A                                       | APT1232AX                                    | APT1232AZ |  |                                      |
|         |                                   |                      | Random                 |              | APT1222               | APT1222A                                       | APT1222AX                                    | APT1222AZ |  |                                      |

Note: For space reasons the initial letters "APT" of the product number for the DIP 4-pin type, the letter "A", which indicates the SMD terminal shape for the DIP 4-pin and 6-pin types, and the package type indications "X" and "Z" have been omitted from the product label. (Example: The label for product number APT1221AZ is 1221.)

## 3. DIP6 Wide Terminal Type

| Type    | Output rating*                    |                      | Type                   | Package size | Part No.              |                              |                              |            | Packing quantity                                       |            |
|---------|-----------------------------------|----------------------|------------------------|--------------|-----------------------|------------------------------|------------------------------|------------|--|------------|
|         | Repetitive peak OFF-state voltage | ON-state RMS current |                        |              | Through hole terminal | Surface-mount terminal       |                              | Tube       | Tape and reel  |            |
|         |                                   |                      |                        |              |                       | Tube packing style           | Tape and reel packing style  |            |  |            |
|         |                                   |                      |                        |              |                       | Picked from the 1/6-pin side | Picked from the 3/4-pin side |            |  |            |
| AC type | 600 V                             | 100 mA               | Zero-cross (max. 50 V) | DIP6pin      | APT1212W              | APT1212WA                    | APT1212WAY                   | APT1212WAW | 1 tube contains: 50 pcs.<br>1 batch contains: 500 pcs. | 1,000 pcs. |
|         |                                   |                      | Zero-cross (max. 15 V) |              | APT1232W              | APT1232WA                    | APT1232WAY                   | APT1232WAW |  |            |
|         |                                   |                      | Random                 |              | APT1222W              | APT1222WA                    | APT1222WAY                   | APT1222WAW |  |            |

Note: For space reasons the initial letters the letter "WA", which indicates the SMD terminal shape for the DIP 6-pin types, and the package type indications "Y" and "W" have been omitted from the product label. (Example: The label for product number APT1212WAY is 1212.)

## RATING

### 1. Absolute maximum ratings (Ambient temperature: 25°C 77°F)

#### 1) SOP4 types

| Item                    |                                   | Symbol       | APT1211S, APT1221S, APT1231S | Remarks                            |
|-------------------------|-----------------------------------|--------------|------------------------------|------------------------------------|
| Input                   | LED forward current               | $I_F$        | 50 mA                        |                                    |
|                         | LED reverse voltage               | $V_R$        | 6 V                          |                                    |
|                         | Peak forward current              | $I_{FP}$     | 1 A                          | f = 100 Hz,<br>Duty Ratio = 0.1%   |
| Output                  | Repetitive peak OFF-state voltage | $V_{DRM}$    | 600 V                        |                                    |
|                         | ON-state RMS current*             | $I_{T(RMS)}$ | 0.05 A                       | AC                                 |
|                         | Non-repetitive surge current      | $I_{TSM}$    | 0.6 A                        | In one cycle at 60 Hz              |
| Total power dissipation |                                   | $P_T$        | 350 mW                       |                                    |
| I/O isolation voltage   |                                   | $V_{iso}$    | 3,750 Vrms                   |                                    |
| Temperature limits      | Operating                         | $T_{opr}$    | -40 to +100°C -40 to +212°F  | Non-condensing at low temperatures |
|                         | Storage                           | $T_{stg}$    | -40 to +125°C -40 to +257°F  |                                    |

Note: "X" and "Z" at the end of the part numbers have been omitted.

#### 2) DIP4/6 type and DIP6 Wide terminal type

| Item                    |                                   | Symbol       | APT1211, APT1221, APT1231, APT1212(W), APT1222(W), APT1232(W) | Remarks                            |
|-------------------------|-----------------------------------|--------------|---|------------------------------------|
| Input                   | LED forward current               | $I_F$        | 50 mA   |                                    |
|                         | LED reverse voltage               | $V_R$        | 6 V   |                                    |
|                         | Peak forward current              | $I_{FP}$     | 1 A   | f = 100 Hz,<br>Duty Ratio = 0.1%   |
| Output                  | Repetitive peak OFF-state voltage | $V_{DRM}$    | 600 V   |                                    |
|                         | ON-state RMS current*             | $I_{T(RMS)}$ | 0.1 A   | AC                                 |
|                         | Non-repetitive surge current      | $I_{TSM}$    | 1.2 A   | In one cycle at 60 Hz              |
| Total power dissipation |                                   | $P_T$        | 500 mW  |                                    |
| I/O isolation voltage   |                                   | $V_{iso}$    | 5,000 Vrms  |                                    |
| Temperature limits      | Operating                         | $T_{opr}$    | -40 to +100°C -40 to +212°F                                   | Non-condensing at low temperatures |
|                         | Storage                           | $T_{stg}$    | -40 to +125°C -40 to +257°F                                   |                                    |

Note: "A", "AX", "AZ" "AY" and "AW" at the end of the part numbers have been omitted.

\* Do not exceed 0.05 A of ON state RMS current in case of following load voltage condition.

DIP4pin (APT1211, APT1221, APT1231): more than 100 Vrms;

DIP6pin (APT1212, APT1222, APT1232) and DIP6pin wide terminal type (APT1212W, APT1222W, APT1232W): more than 120 Vrms.

## 2. Characteristics (Ambient temperature: 25°C 77°F)

### 1) Zero-cross type (max. 50 V) and random type

| Item                                       |                                   | Symbol  | APT1211S, APT1211, APT1212(W) | APT1221S, APT1221, APT1222(W) | Condition  |
|--|-----------------------------------|---------|-------------------------------|-------------------------------|--|
| Input                                      | LED dropout voltage               | Typical | 1.21 V                        |                               | $I_F = 20 \text{ mA}$  |
|  |                                   | Maximum | 1.3 V                         |                               |  |
|  | LED reverse current               | Typical | —                             |                               | $V_R = 6 \text{ V}$  |
|  |                                   | Maximum | 10 $\mu\text{A}$              |                               |  |
| Output                                     | Repetitive peak OFF-state current | Typical | —                             |                               | $I_F = 0 \text{ mA}$<br>$V_{DRM} = 600 \text{ V}$                  |
|  |                                   | Maximum | 1 $\mu\text{A}$               |                               |  |
|  | Repetitive peak On-state voltage  | Typical | 1.3 V                         |                               | $I_F = 10 \text{ mA}$<br>$I_{TM} = 0.05 \text{ A}$                 |
|  |                                   | Maximum | 2.5 V                         |                               |  |
| Holding current                            | Typical                           | 0.3 mA  |                               |                               |  |
|  | Maximum                           | 3.5 mA  |                               |                               |  |
| Critical rate of rise of OFF-state voltage | Minimum                           | dv/dt   | 500 V/ $\mu\text{s}$          |                               | $V_{DRM} = 600 \text{ V} \times 1/\sqrt{2}$                        |
| Transfer characteristics                   | Trigger LED current               | Maximum | $I_{FT}$                      | 10 mA                         | $V_D = 6 \text{ V}$<br>$R_L = 100 \Omega$                          |
|  | Zero-cross voltage                | Maximum | $V_{ZC}$                      | 50 V                          | $I_F = 10 \text{ mA}$  |
|  | Turn on time*                     | Maximum | $T_{on}$                      | 100 $\mu\text{s}$             | $I_F = 20 \text{ mA}$<br>$V_D = 6 \text{ V}$<br>$R_L = 100 \Omega$ |
|  | I/O capacitance                   | Maximum | $C_{iso}$                     | 1.5 pF                        | $f = 1 \text{ MHz}$<br>$V_B = 0 \text{ V}$                         |
|  | I/O isolation resistance          | Minimum | $R_{iso}$                     | 50 G $\Omega$                 | 500 V DC   |

Note: 1. For type of connection, see "SCHEMATIC AND WIRING DIAGRAMS".

#### \*Turn on time



### 2) Zero-cross type (max. 15 V)

| Item                                       |                                   | Symbol  | APT1231S, APT1231, APT1232(W) |                   | Condition  |
|--|-----------------------------------|---------|-------------------------------|-------------------|--|
| Input                                      | LED dropout voltage               | Typical | 1.21 V                        |                   | $I_F = 20 \text{ mA}$                              |
|  |                                   | Maximum | 1.3 V                         |                   |  |
|  | LED reverse current               | Typical | —                             |                   | $V_R = 6 \text{ V}$                                |
|  |                                   | Maximum | 10 $\mu\text{A}$              |                   |  |
| Output                                     | Repetitive peak OFF-state current | Typical | —                             |                   | $I_F = 0 \text{ mA}$<br>$V_{DRM} = 600 \text{ V}$  |
|  |                                   | Maximum | 1 $\mu\text{A}$               |                   |  |
|  | Repetitive peak On-state voltage  | Typical | 1.2 V                         |                   | $I_F = 10 \text{ mA}$<br>$I_{TM} = 0.03 \text{ A}$ |
|  |                                   | Maximum | 2 V                           |                   |  |
| Holding current                            | Typical                           | 0.3 mA  |                               |                   |  |
|  | Maximum                           | 3.5 mA  |                               |                   |  |
| Critical rate of rise of OFF-state voltage | Minimum                           | dv/dt   | 500 V/ $\mu\text{s}$          |                   | $V_{DRM} = 600 \text{ V} \times 1/\sqrt{2}$        |
| Transfer characteristics                   | Trigger LED current               | Maximum | $I_{FT}$                      | 10 mA             | $I_{TM} = 0.03 \text{ A}$                          |
|  | Zero-cross voltage                | Maximum | $V_{ZC}$                      | 15 V              | $I_F = 10 \text{ mA}$                              |
|  | Turn on time*                     | Maximum | $T_{on}$                      | 100 $\mu\text{s}$ | $I_F = 20 \text{ mA}$<br>$I_{TM} = 0.03 \text{ A}$ |
|  | I/O capacitance                   | Maximum | $C_{iso}$                     | 1.5 pF            | $f = 1 \text{ MHz}$<br>$V_B = 0 \text{ V}$         |
|  | I/O isolation resistance          | Minimum | $R_{iso}$                     | 50 G $\Omega$     | 500 V DC   |

Note: 1. For type of connection, see "SCHEMATIC AND WIRING DIAGRAMS".

#### \*Turn on time



## RECOMMENDED OPERATING CONDITIONS

Please use under recommended operating conditions to obtain expected characteristics.

| Item              | Symbol | Min. | Max. | Unit |
|-------------------|--------|------|------|------|
| Input LED current | $I_F$  | 15   | 25   | mA   |

## REFERENCE DATA

1-(1). ON-state RMS current vs. ambient temperature characteristics

Allowable ambient temperature: -40 to +100°C  
-40 to +212°F

Tested sample: APT1211S, APT1221S



1-(2). ON-state RMS current vs. ambient temperature characteristics

Allowable ambient temperature: -40 to +100°C  
-40 to +212°F

Tested sample: APT1231S



1-(3). ON-state RMS current vs. ambient temperature characteristics

Allowable ambient temperature: -40 to +100°C  
-40 to +212°F

Tested sample: APT1211(A), APT1221(A)



1-(4). ON-state RMS current vs. ambient temperature characteristics

Allowable ambient temperature: -40 to +100°C  
-40 to +212°F

Tested sample: APT1231(A)



1-(5). ON-state RMS current vs. ambient temperature characteristics

Allowable ambient temperature: -40 to +100°C  
-40 to +212°F

Tested sample: APT1212(A), APT1222(A),  
APT1212W(A), APT1222W(A)



1-(6). ON-state RMS current vs. ambient temperature characteristics

Allowable ambient temperature: -40 to +100°C  
-40 to +212°F

Tested sample: APT1232(A), APT1232W(A)



2. On voltage vs. ambient temperature characteristics



3. Trigger LED current vs. ambient temperature characteristics



4. LED dropout voltage vs. ambient temperature characteristics



5. Turn on time vs. LED current characteristics



6. Repetitive peak OFF-state current vs. Load voltage characteristics



7. Hold current vs. ambient temperature characteristics



## 8. Zero-cross voltage vs. ambient temperature characteristics



## DIMENSIONS (mm inch)

The CAD data of the products with a **CAD** mark can be downloaded from: <https://industrial.panasonic.com/ac/e/>

### 1. SOP Type

APT1211S, APT1221S, APT1231S

**CAD**



#### External dimensions



#### Recommended mounting pad (TOP VIEW)



Tolerance: ±0.1 ±.004

Terminal thickness = 0.15 ±.006  
General tolerance: ±0.1 ±.004

### 2. DIP4 Type

APT1211(A), APT1221(A), APT1231(A)

**CAD**



#### External dimensions

##### Through hole terminal type



##### Surface mount terminal type



Terminal thickness = 0.20 ±.008  
General tolerance: ±0.1 ±.004

#### PC board pattern (BOTTOM VIEW)



Tolerance: ±0.1 ±.004

#### Recommended mounting pad (TOP VIEW)

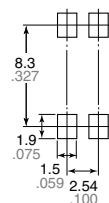

Tolerance: ±0.1 ±.004

3. DIP6 Type

APT1212(A), APT1222(A), APT1232(A)

CAD



External dimensions

Through hole terminal type



Surface mount terminal type



Terminal thickness =  $0.25 \pm 0.010$   
General tolerance:  $\pm 0.1 \pm 0.004$

PC board pattern (BOTTOM VIEW)



Tolerance:  $\pm 0.1 \pm 0.004$

Recommended mounting pad (TOP VIEW)



Tolerance:  $\pm 0.1 \pm 0.004$

4. DIP6 Wide Terminal Type

APT1212W(A), APT1222W(A), APT1232W(A)

CAD



External dimensions

Through hole terminal type



Surface mount terminal type

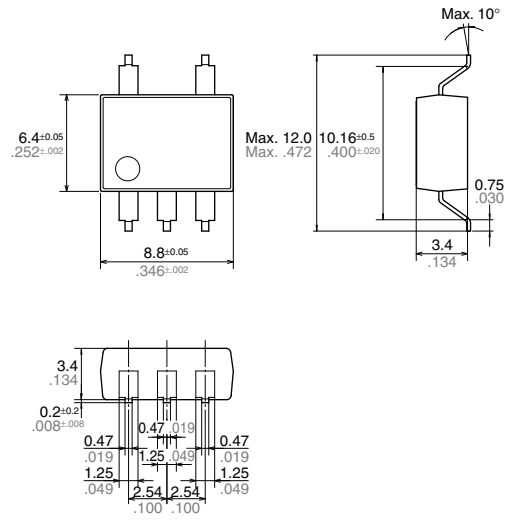

Terminal thickness = 0.25 .010  
General tolerance: ±0.1 ±.004

PC board pattern (BOTTOM VIEW)

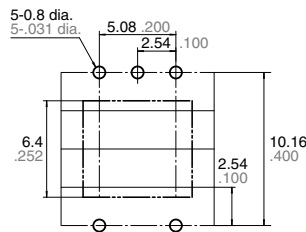

Recommended mounting pad (TOP VIEW)

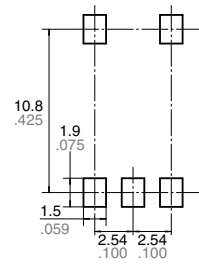

Tolerance: ±0.1 ±.004

Tolerance: ±0.1 ±.004

SCHEMATIC AND WIRING DIAGRAMS

| Schematic                 | Output configuration | Load | Wiring diagram                    |
|---------------------------|----------------------|------|-----------------------------------|
| <p>Zero-cross circuit</p> | 1 Form A             | AC   | <p>Power source at input side</p> |
| <p>Zero-cross circuit</p> |                      |      | <p>Load power supply</p>          |
| <p>Zero-cross circuit</p> |                      |      | <p>Power source at input side</p> |
| <p>Zero-cross circuit</p> |                      |      | <p>Load power supply</p>          |



---

Please contact .....

**Panasonic Corporation**

Electromechanical Control Business Division

■ 1006, Oaza Kadoma, Kadoma-shi, Osaka 571-8506, Japan  
[industrial.panasonic.com/ac/e/](http://industrial.panasonic.com/ac/e/)

**Panasonic**<sup>®</sup>

©Panasonic Corporation 2018

# Mouser Electronics

Authorized Distributor

Click to View Pricing, Inventory, Delivery & Lifecycle Information:

## Panasonic:

[APT1211](#) [APT1211AX](#) [APT1211AZ](#) [APT1211SX](#) [APT1211SZ](#) [APT1211W](#) [APT1211WA](#) [APT1211WAW](#)  
[APT1211WAY](#) [APT1212A](#) [APT1212AX](#) [APT1212AZ](#) [APT1212W](#) [APT1212WA](#) [APT1212WAW](#) [APT1212WAY](#)  
[APT1221AX](#) [APT1221AZ](#) [APT1221SX](#) [APT1221SZ](#) [APT1221W](#) [APT1221WA](#) [APT1221WAW](#) [APT1221WAY](#)  
[APT1222A](#) [APT1222AX](#) [APT1222AZ](#) [APT1222W](#) [APT1222WA](#) [APT1222WAW](#) [APT1222WAY](#) [APT1232A](#)  
[APT1212D05](#) [APT1222D05](#)

Компания «Океан Электроники» предлагает заключение долгосрочных отношений при поставках импортных электронных компонентов на взаимовыгодных условиях!

Наши преимущества:

- Поставка оригинальных импортных электронных компонентов напрямую с производств Америки, Европы и Азии, а так же с крупнейших складов мира;
- Широкая линейка поставок активных и пассивных импортных электронных компонентов (более 30 млн. наименований);
- Поставка сложных, дефицитных, либо снятых с производства позиций;
- Оперативные сроки поставки под заказ (от 5 рабочих дней);
- Экспресс доставка в любую точку России;
- Помощь Конструкторского Отдела и консультации квалифицированных инженеров;
- Техническая поддержка проекта, помощь в подборе аналогов, поставка прототипов;
- Поставка электронных компонентов под контролем ВП;
- Система менеджмента качества сертифицирована по Международному стандарту ISO 9001;
- При необходимости вся продукция военного и аэрокосмического назначения проходит испытания и сертификацию в лаборатории (по согласованию с заказчиком);
- Поставка специализированных компонентов военного и аэрокосмического уровня качества (Xilinx, Altera, Analog Devices, Intersil, Interpoint, Microsemi, Actel, Aeroflex, Peregrine, VPT, Syfer, Eurofarad, Texas Instruments, MS Kennedy, Miteq, Cobham, E2V, MA-COM, Hittite, Mini-Circuits, General Dynamics и др.);

Компания «Океан Электроники» является официальным дистрибьютором и эксклюзивным представителем в России одного из крупнейших производителей разъемов военного и аэрокосмического назначения «JONHON», а так же официальным дистрибьютором и эксклюзивным представителем в России производителя высокотехнологичных и надежных решений для передачи СВЧ сигналов «FORSTAR».



## JONHON

«JONHON» (основан в 1970 г.)

Разъемы специального, военного и аэрокосмического назначения:

(Применяются в военной, авиационной, аэрокосмической, морской, железнодорожной, горно- и нефтедобывающей отраслях промышленности)

«FORSTAR» (основан в 1998 г.)

ВЧ соединители, коаксиальные кабели,  
кабельные сборки и микроволновые компоненты:

(Применяются в телекоммуникациях гражданского и специального назначения, в средствах связи, РЛС, а так же военной, авиационной и аэрокосмической отраслях промышленности).



Телефон: 8 (812) 309-75-97 (многоканальный)

Факс: 8 (812) 320-03-32

Электронная почта: [ocean@oceanchips.ru](mailto:ocean@oceanchips.ru)

Web: <http://oceanchips.ru/>

Адрес: 198099, г. Санкт-Петербург, ул. Калинина, д. 2, корп. 4, лит. А