

DAISY-4X1-WW

~80° wide beam

TECHNICAL SPECIFICATIONS:

Dimensions	182.0 x 40.0 mm
Height	20.2 mm
Fastening	pin, screw, clips
ROHS compliant	yes ⓘ

MATERIAL SPECIFICATIONS:

Component	Type	Material	Colour	Finish
C16584_DAISY-4X1-WW	Linear lens	PMMA	clear	
C16590_DAISY-4X1-SHD	Shade	PC-ABS	black	gloss
C16784_DAISY-4X1-SHD-WHT	Shade	PC	white	gloss
C17422_DAISY-4X1-SHD2-MATT	Shade	PC	black	matt
C17423_DAISY-4X1-SHD2-WHT-MATT	Shade	PC	white	matt
C17528_DAISY-4X1-SHD-MET	Shade	PC-ABS	metal	gloss
C17535_DAISY-4X1-SHD2-MET-MATT	Shade	PC	metal	matt

ORDERING INFORMATION:

Quantities for one set:

Linear lens	1
Shade	1

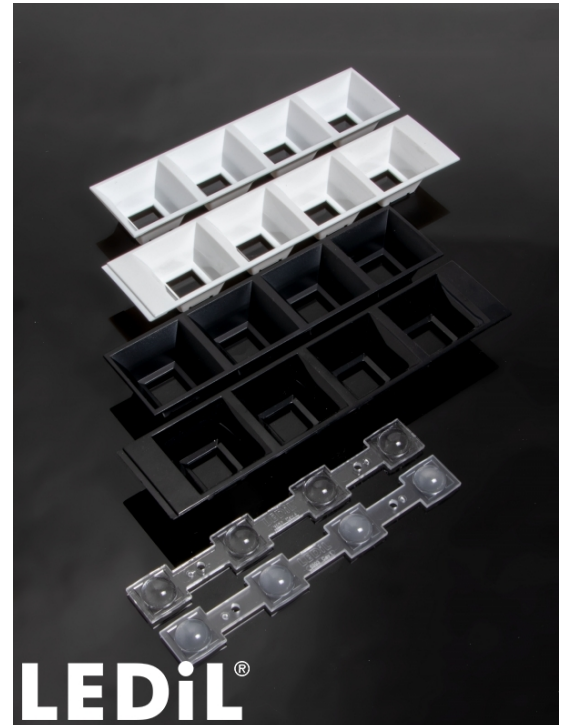

Component		Qty in box	MOQ	MPQ	Box weight (kg)
C16584_DAISY-4X1-WW	Linear lens	504	336	21	5.6
» Box size: 480 x 280 x 300 mm					
C17535_DAISY-4X1-SHD2-MET-MATT	Shade	168	336	42	
» Box size: 480 x 280 x 300 mm					
C17422_DAISY-4X1-SHD2-MATT	Shade	168	336	42	4.1
» Box size: 480 x 280 x 300 mm					
C17423_DAISY-4X1-SHD2-WHT-MATT	Shade	168	336	42	4.4
» Box size: 480 x 280 x 300 mm					
C16590_DAISY-4X1-SHD	Shade	168	336	42	4.3
» Box size: 480 x 280 x 300 mm					
C17528_DAISY-4X1-SHD-MET	Shade	168	336	42	
» Box size: 480 x 280 x 300 mm					
C16784_DAISY-4X1-SHD-WHT	Shade	168	336	42	4.3
» Box size: 480 x 280 x 300 mm					

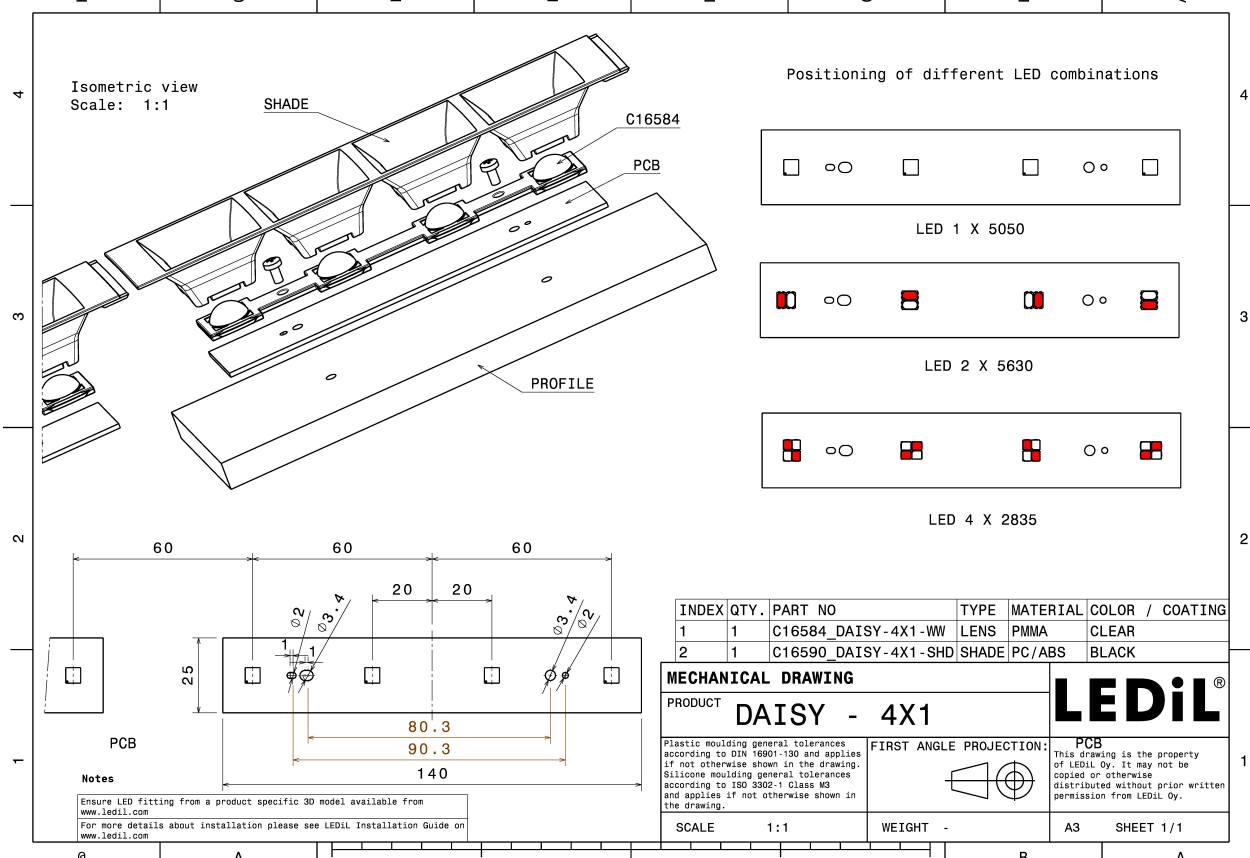
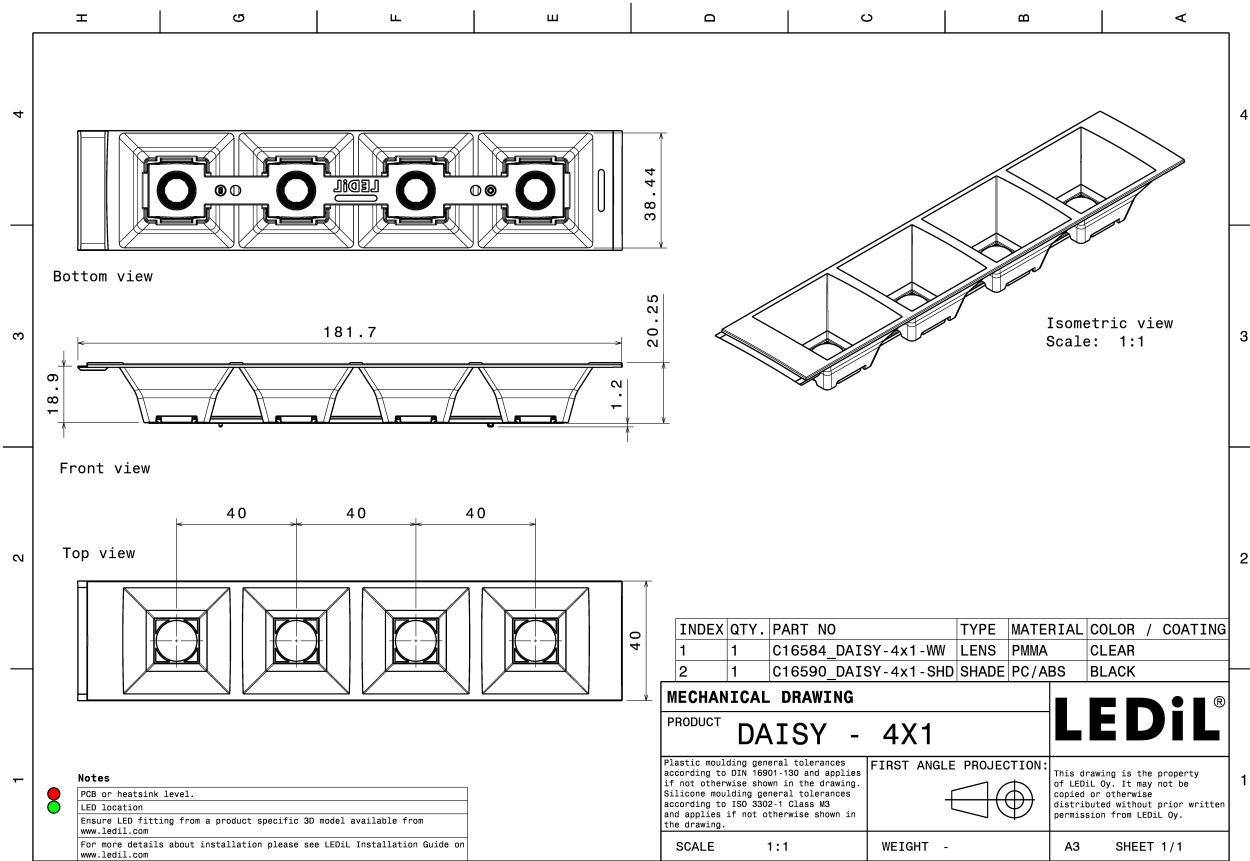

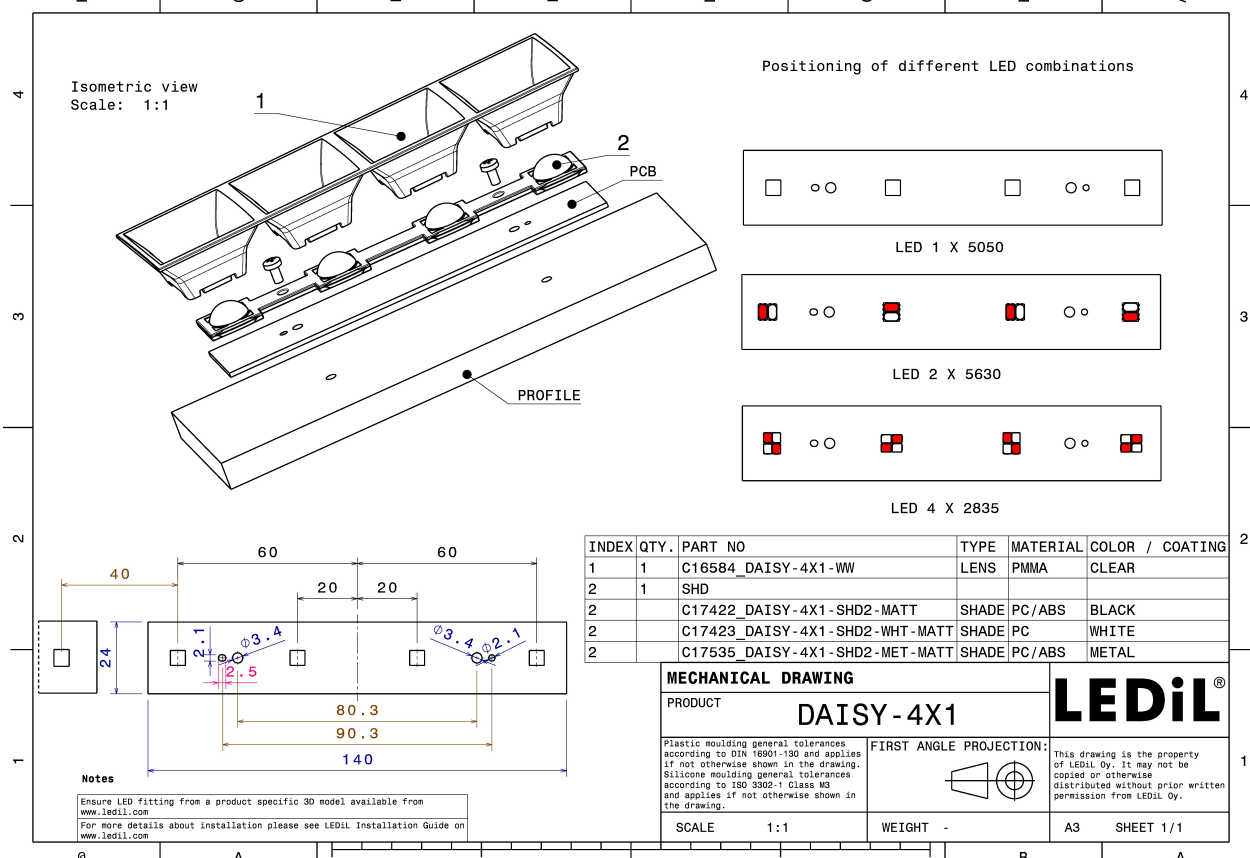
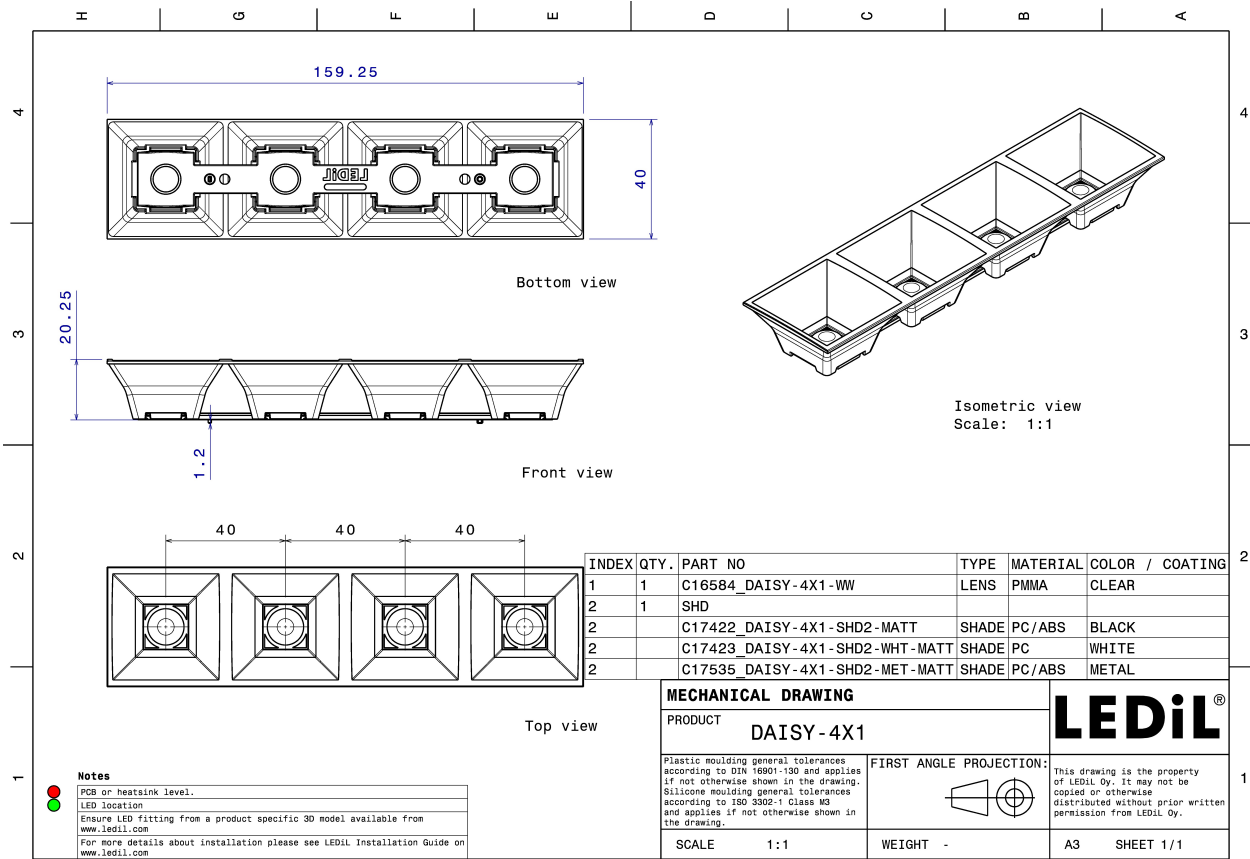

PHOTOMETRIC DATA (MEASURED):



LED J Series 2835
 FWHM 77.0°
 Efficiency 86 %
 Peak intensity 0.6 cd/lm
 LEDs/each optic 2
 Light colour White
 Required components:
 C16590_DAISY-4X1-SHD

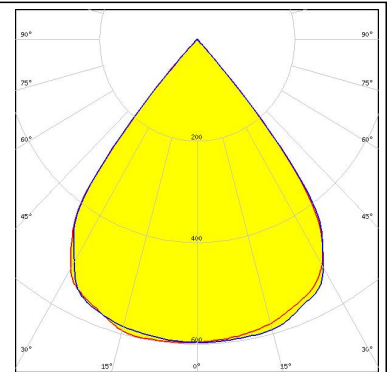

LED LG 3528
 FWHM 77.0°
 Efficiency 86 %
 Peak intensity 0.6 cd/lm
 LEDs/each optic 2
 Light colour White
 Required components:
 C16590_DAISY-4X1-SHD

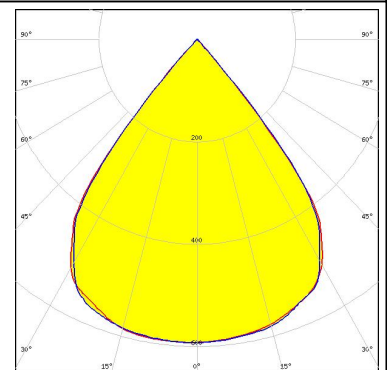

LED LUXEON 2835 Line
 FWHM 78.0°
 Efficiency 87 %
 Peak intensity 0.6 cd/lm
 LEDs/each optic 2
 Light colour White
 Required components:
 C16590_DAISY-4X1-SHD

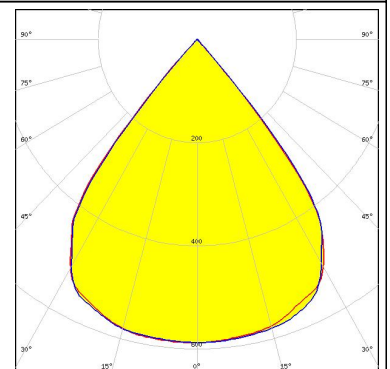

LED LinLED 156x28mm 2x200lm 827-865 2x2C 12V
 FWHM 77.0°
 Efficiency 85 %
 Peak intensity 0.6 cd/lm
 LEDs/each optic 1
 Light colour White
 Required components:
 C16590_DAISY-4X1-SHD

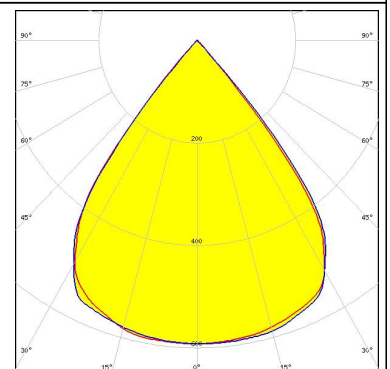
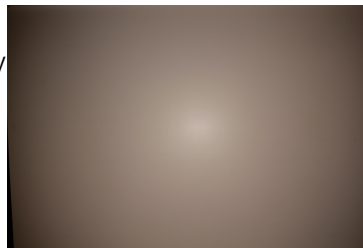

PHOTOMETRIC DATA (MEASURED):

MST *Your solutions*

LED LinLED 156x28mm 400lm 8x0 2C 12V Opt G1
 FWHM 77.0°
 Efficiency 87 %
 Peak intensity 0.6 cd/lm
 LEDs/each optic 1
 Light colour White
 Required components:
 C16590_DAISY-4X1-SHD

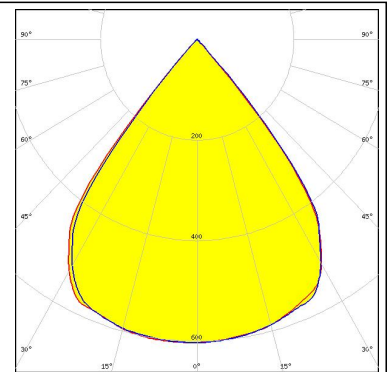

NICHIA

LED NF2W757G-MT (Tunable White)
 FWHM 79.0°
 Efficiency 86 %
 Peak intensity 0.6 cd/lm
 LEDs/each optic 1
 Light colour Tunable White
 Required components:
 C16590_DAISY-4X1-SHD

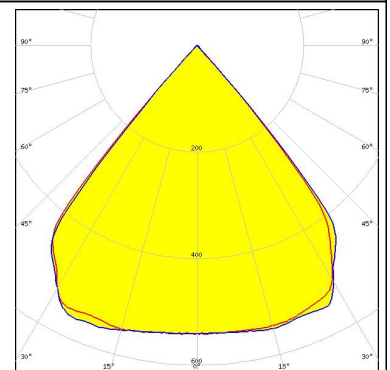
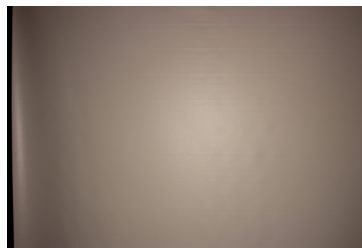

NICHIA

LED NF2W757G-MT (Tunable White)
 FWHM 79.0°
 Efficiency 96 %
 Peak intensity 0.6 cd/lm
 LEDs/each optic 1
 Light colour Tunable White
 Required components:
 C16784_DAISY-4X1-SHD-WHT

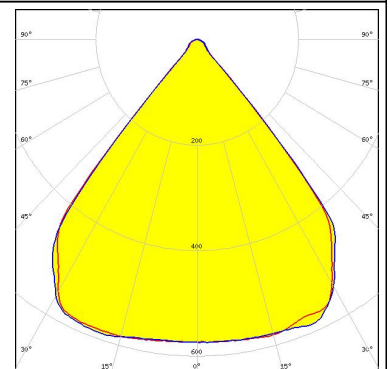
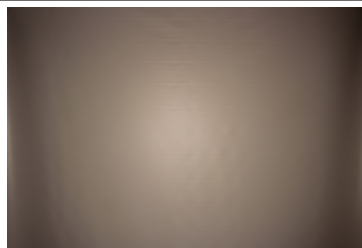

SAMSUNG

LED LM28xB Series
 FWHM 78.0°
 Efficiency 84 %
 Peak intensity 0.6 cd/lm
 LEDs/each optic 2
 Light colour White
 Required components:
 C16590_DAISY-4X1-SHD

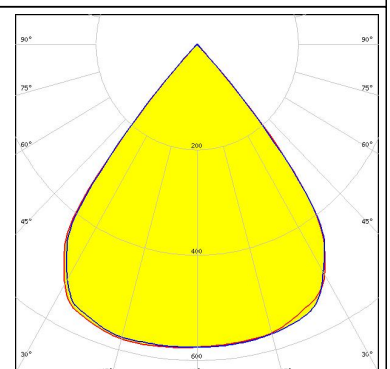

PHOTOMETRIC DATA (MEASURED):

SAMSUNG

LED LM28xB Series
 FWHM 75.0°
 Efficiency 84 %
 Peak intensity 0.6 cd/lm
 LEDs/each optic 4
 Light colour White
 Required components:
 C16590_DAISSY-4X1-SHD

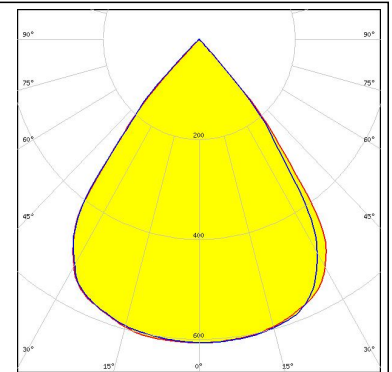

SAMSUNG

LED LM28xB Series
 FWHM 76.0°
 Efficiency 94 %
 Peak intensity 0.6 cd/lm
 LEDs/each optic 4
 Light colour White
 Required components:
 C16784_DAISSY-4X1-SHD-WHT

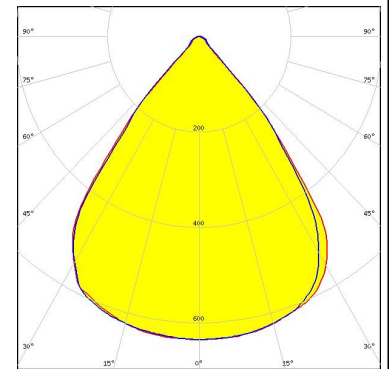
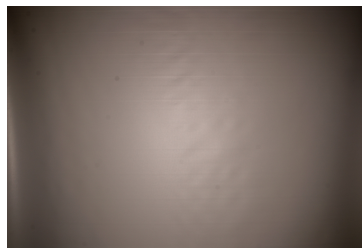

SAMSUNG

LED LM28xB Series
 FWHM 76.0°
 Efficiency 86 %
 Peak intensity 0.6 cd/lm
 LEDs/each optic 1
 Light colour White
 Required components:
 C17422_DAISSY-4X1-SHD2-MATT

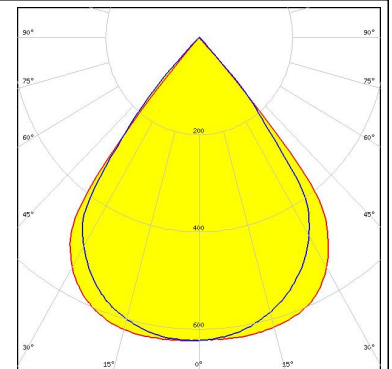
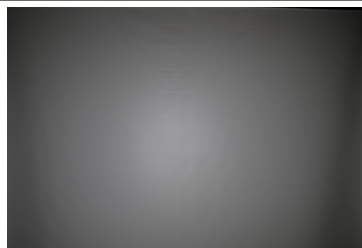





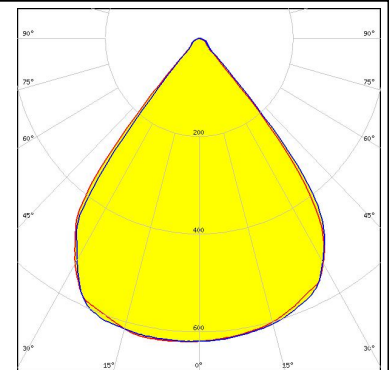
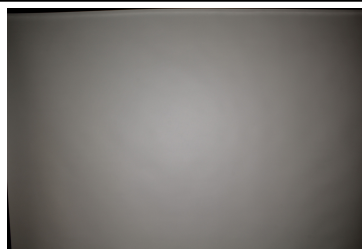

SAMSUNG

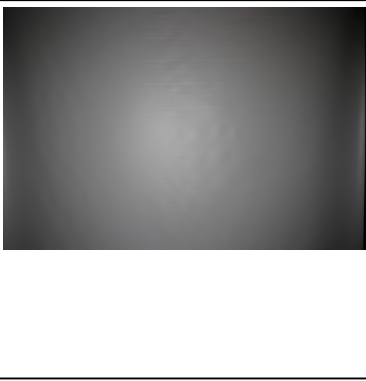
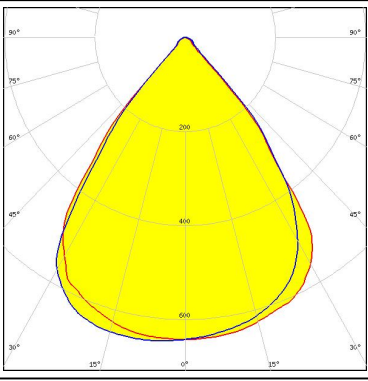

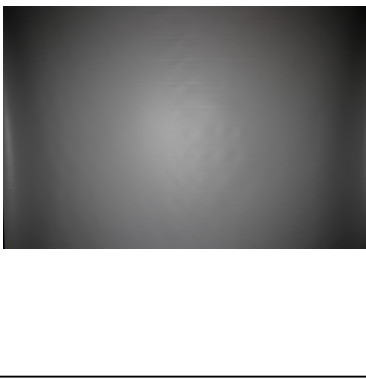
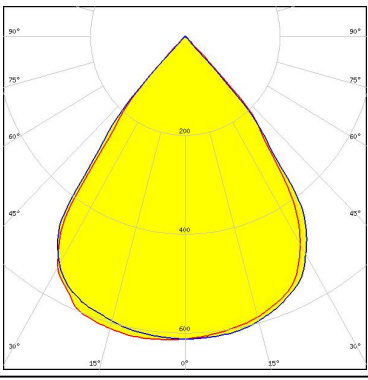
LED LM28xB Series
 FWHM 77.0°
 Efficiency 94 %
 Peak intensity 0.6 cd/lm
 LEDs/each optic 2
 Light colour White
 Required components:
 C16784_DAISSY-4X1-SHD-WHT

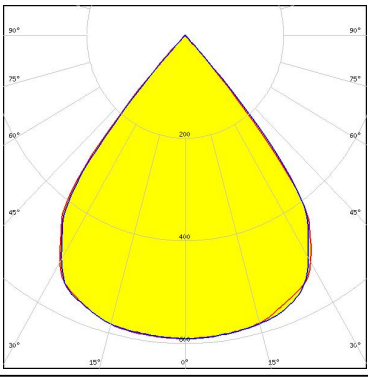

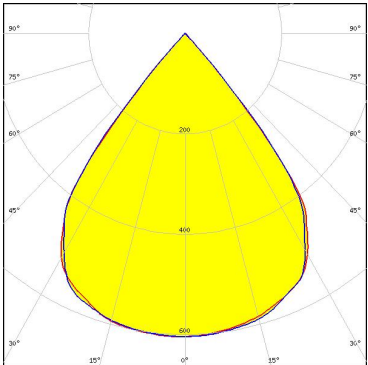
PHOTOMETRIC DATA (MEASURED):

<p> SEOUL SEMICONDUCTOR</p> <p>LED SEOUL DC 3030 FWHM 75.0° Efficiency 92 % Peak intensity 0.7 cd/lm LEDs/each optic 4 Light colour Tunable White Required components: C16784_DAISY-4X1-SHD-WHT</p>		
<p> SEOUL SEMICONDUCTOR</p> <p>LED SEOUL DC 3030 FWHM 75.0° Efficiency 83 % Peak intensity 0.6 cd/lm LEDs/each optic 4 Light colour Tunable White Required components: C16590_DAISY-4X1-SHD</p>		
<p> SEOUL SEMICONDUCTOR</p> <p>LED SEOUL DC 3528 FWHM 78.0° Efficiency 87 % Peak intensity 0.6 cd/lm LEDs/each optic 2 Light colour White Required components: C16590_DAISY-4X1-SHD</p>		
<p> SEOUL SEMICONDUCTOR</p> <p>LED SEOUL DC 3528 FWHM 77.0° Efficiency 87 % Peak intensity 0.6 cd/lm LEDs/each optic 2 Light colour White Required components: C16590_DAISY-4X1-SHD</p>		

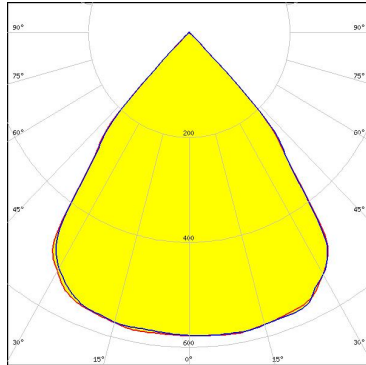
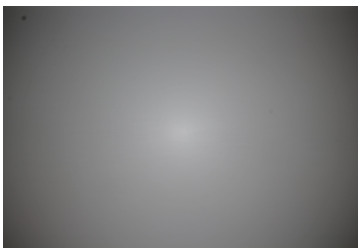
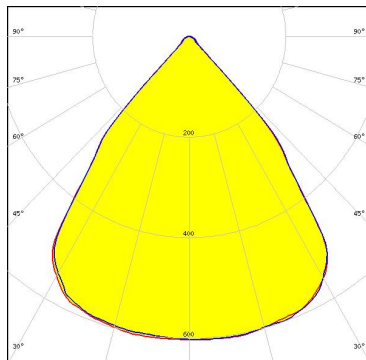
PHOTOMETRIC DATA (MEASURED):

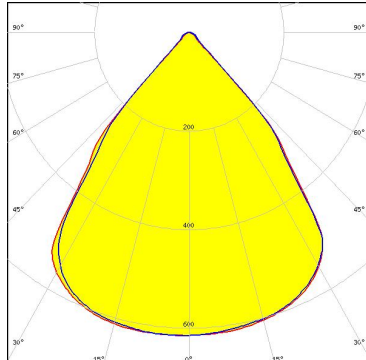
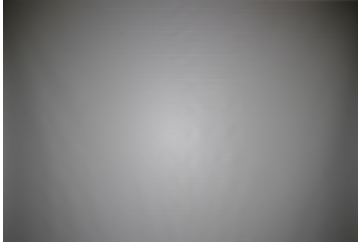
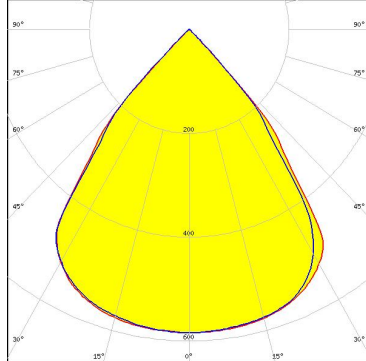
<p>TEPCOMP group</p> <p>LED PassivePAQ-L-0.5F35-SSA3-1.6K-840-3-DC FWHM 79.0° Efficiency 85 % Peak intensity 0.6 cd/lm LEDs/each optic 4 Light colour White Required components: C16590_DAISSY-4X1-SHD</p>		
<p>TEPCOMP group</p> <p>LED PassivePAQ-L-0.5F35-SSA3-1.6K-840-3-DC FWHM 80.0° Efficiency 94 % Peak intensity 0.6 cd/lm LEDs/each optic 4 Light colour White Required components: C16784_DAISSY-4X1-SHD-WHT</p>		
<p>TEPCOMP group</p> <p>LED PassivePAQ-L-0.5F35-SSA3-1.6K-840-3-DC FWHM 79.0° Efficiency 94 % Peak intensity 0.6 cd/lm LEDs/each optic 4 Light colour White Required components: C17423_DAISSY-4X1-SHD2-WHT-MATT</p>		
<p>TEPCOMP group</p> <p>LED PassivePAQ-L-0.5F35-SSA3-1.6K-840-3-DC FWHM 80.0 + 77.0° Efficiency 83 % Peak intensity 0.6 cd/lm LEDs/each optic 4 Light colour White Required components: C17422_DAISSY-4X1-SHD2-MATT</p>		

PHOTOMETRIC DATA (MEASURED):

TRIDONIC

LED LLE 24x140mm 400lm 827-865 LVD ADV1
 FWHM 76.0°
 Efficiency 85 %
 Peak intensity 0.6 cd/lm
 LEDs/each optic 4
 Light colour White
 Required components:
 C16590_DAISSY-4X1-SHD

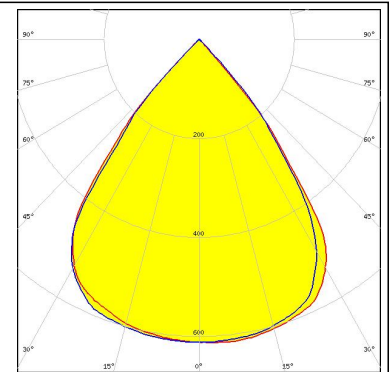
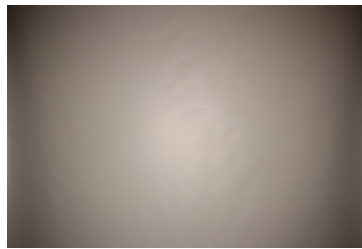

TRIDONIC

LED LLE 24x140mm 400lm 827-865 LVD ADV1
 FWHM 76.0°
 Efficiency 94 %
 Peak intensity 0.6 cd/lm
 LEDs/each optic 4
 Light colour White
 Required components:
 C16784_DAISSY-4X1-SHD-WHT

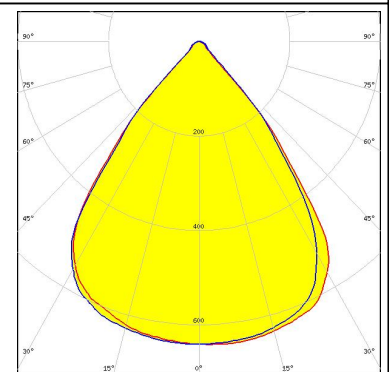
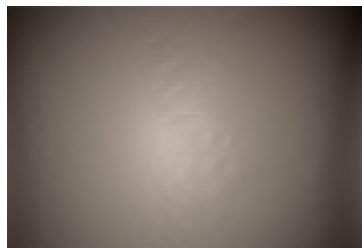

TRIDONIC

LED LLE 24x140mm 400lm 8x0 LVD ADV1
 FWHM 76.0°
 Efficiency 85 %
 Peak intensity 0.6 cd/lm
 LEDs/each optic 4
 Light colour White
 Required components:
 C16590_DAISSY-4X1-SHD

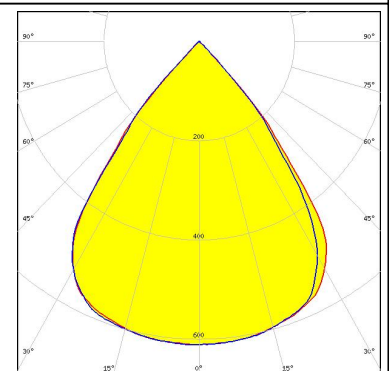
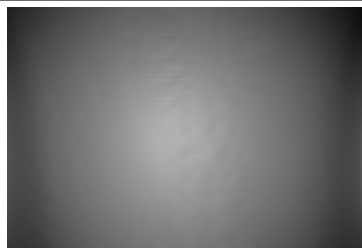

TRIDONIC

LED LLE 24x140mm 400lm 8x0 LVD ADV1
 FWHM 77.0°
 Efficiency 94 %
 Peak intensity 0.6 cd/lm
 LEDs/each optic 4
 Light colour White
 Required components:
 C16784_DAISSY-4X1-SHD-WHT

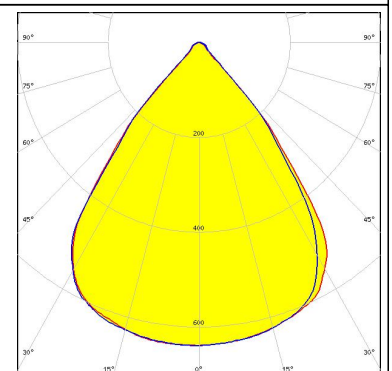
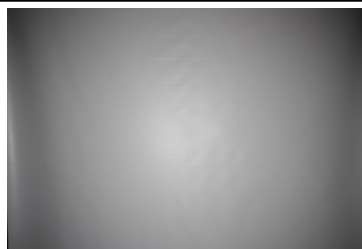

PHOTOMETRIC DATA (MEASURED):

TRIDONIC

LED LLE 24x280mm 750lm 8x0 LVD ADV1
FWHM 76.0°
Efficiency 94 %
Peak intensity 0.6 cd/lm
LEDs/each optic 4
Light colour White
Required components:
C16784_DAISY-4X1-SHD-WHT

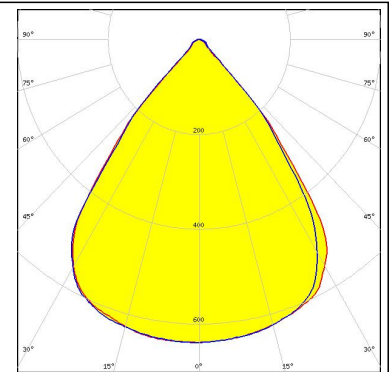
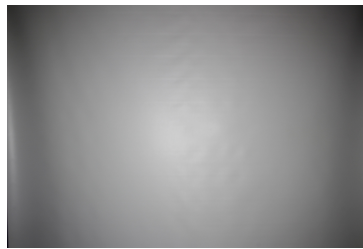

TRIDONIC

LED LLE 24x280mm 750lm 8x0 LVD ADV1
FWHM 76.0°
Efficiency 85 %
Peak intensity 0.6 cd/lm
LEDs/each optic 4
Light colour White
Required components:
C16590_DAISY-4X1-SHD

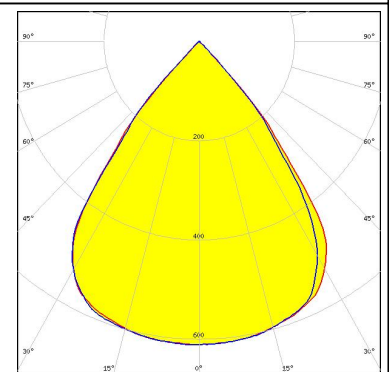
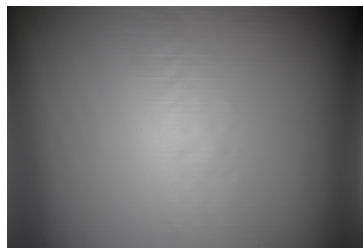

PHOTOMETRIC DATA (SIMULATED):

<p>LUMILEDS</p> <p>LED LUXEON 3535L FWHM 76.0° Efficiency 90 % Peak intensity 0.7 cd/lm LEDs/each optic 1 Light colour White Required components: C16590_DAISY-4X1-SHD</p>	
<p>LUMILEDS</p> <p>LED LUXEON 5050 Round LES FWHM 76.0° Efficiency 90 % Peak intensity 0.7 cd/lm LEDs/each optic 1 Light colour White Required components: C16590_DAISY-4X1-SHD</p>	
<p>NICHIA</p> <p>LED NF2W757G-MT (Tunable White) FWHM 76.0 + 78.0° Efficiency 90 % Peak intensity 0.7 cd/lm LEDs/each optic 2 Light colour Tunable White Required components: C16590_DAISY-4X1-SHD</p>	
<p>NICHIA</p> <p>LED NF2W757G-MT (Tunable White) FWHM 76.0° Efficiency 90 % Peak intensity 0.7 cd/lm LEDs/each optic 4 Light colour Tunable White Required components: C16590_DAISY-4X1-SHD</p>	

PHOTOMETRIC DATA (SIMULATED):

OSRAM Opto Semiconductors

LED Duris E 2835
 FWHM 80.0°
 Efficiency 83 %
 Peak intensity 0.6 cd/lm
 LEDs/each optic 1
 Light colour White
 Required components:
 C16590_DAISY-4X1-SHD

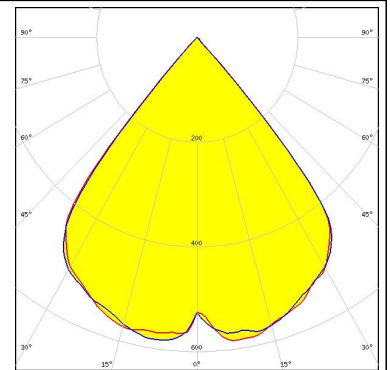

OSRAM Opto Semiconductors

LED Duris S8
 FWHM 76.0°
 Efficiency 90 %
 Peak intensity 0.7 cd/lm
 LEDs/each optic 1
 Light colour White
 Required components:
 C16590_DAISY-4X1-SHD

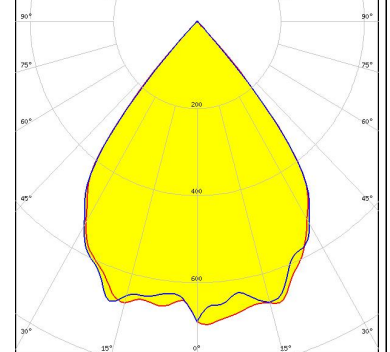

OSRAM Opto Semiconductors

LED Duris S8
 FWHM 76.0°
 Efficiency 95 %
 Peak intensity 0.7 cd/lm
 LEDs/each optic 1
 Light colour White
 Required components:
 C16784_DAISY-4X1-SHD-WHT

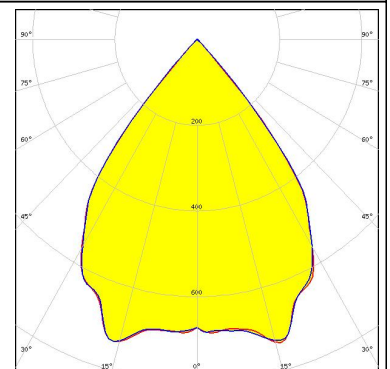

SAMSUNG

LED LH351B
 FWHM 79.0°
 Efficiency 90 %
 Peak intensity 0.6 cd/lm
 LEDs/each optic 1
 Light colour White
 Required components:
 C16590_DAISY-4X1-SHD

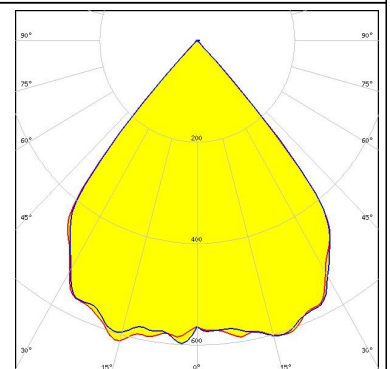

GENERAL INFORMATION:

NOTE: The typical beam angle will be changed by different color, chip size and chip position tolerance. The typical total beam angle is the full angle measured where the luminous intensity is half of the peak value.

MATERIALS:

As part of our continuous research and improvement processes, and to ensure the best possible quality and availability of our products, LEDiL reserves the right to change material grades without notice.

PRODUCT DATA USER AGREEMENT AND DISCLAIMER:

The measured data in the provided downloadable LEDiL Product Datasheets and Mechanical 2D-Drawings is rounded and provided as reference for planning. LEDiL Oy's optical specifications have been verified by conducting performance testing of the products in accordance with the company's quality system. The reported data are averaged results of multiple measurements with typical variation. LEDiL Oy reserves the right to without prior notification make changes and improvements to its products.

LEDiL Oy assumes neither warranty, nor guarantee nor any other liability of any kind for the contents and correctness of the provided data. The provided data has been generated with highest diligence but the provided data may in reality not represent the complete possible variation range of all intrinsic parameters. Therefore, in certain cases a deviation from the provided data could occur.

LEDiL Oy reserves the right to undertake technical changes of its products without further notification which could lead to changes in the provided data. LEDiL Oy assumes no liability of any kind for the possible deviation from any provided data or any other damage resulting from the usage of the provided data.

The user agrees to this disclaimer and user agreement with the download or usage of the provided files.

LEDiL Oy

Joensuunkatu 13
FI-24240 SALO
Finland

LEDiL Inc.

228 West Page Street
Suite D
Sycamore IL 60178
USA

Local sales and technical support

[www.ledil.com/
where_to_buy](http://www.ledil.com/where_to_buy)

Shipping locations

Salo, Finland
Hong Kong, China

Distribution Partners

[www.ledil.com/
where_to_buy](http://www.ledil.com/where_to_buy)

Компания «Океан Электроники» предлагает заключение долгосрочных отношений при поставках импортных электронных компонентов на взаимовыгодных условиях!

Наши преимущества:

- Поставка оригинальных импортных электронных компонентов напрямую с производств Америки, Европы и Азии, а так же с крупнейших складов мира;
- Широкая линейка поставок активных и пассивных импортных электронных компонентов (более 30 млн. наименований);
- Поставка сложных, дефицитных, либо снятых с производства позиций;
- Оперативные сроки поставки под заказ (от 5 рабочих дней);
- Экспресс доставка в любую точку России;
- Помощь Конструкторского Отдела и консультации квалифицированных инженеров;
- Техническая поддержка проекта, помощь в подборе аналогов, поставка прототипов;
- Поставка электронных компонентов под контролем ВП;
- Система менеджмента качества сертифицирована по Международному стандарту ISO 9001;
- При необходимости вся продукция военного и аэрокосмического назначения проходит испытания и сертификацию в лаборатории (по согласованию с заказчиком);
- Поставка специализированных компонентов военного и аэрокосмического уровня качества (Xilinx, Altera, Analog Devices, Intersil, Interpoint, Microsemi, Actel, Aeroflex, Peregrine, VPT, Syfer, Eurofarad, Texas Instruments, MS Kennedy, Miteq, Cobham, E2V, MA-COM, Hittite, Mini-Circuits, General Dynamics и др.);

Компания «Океан Электроники» является официальным дистрибьютором и эксклюзивным представителем в России одного из крупнейших производителей разъемов военного и аэрокосмического назначения «JONHON», а так же официальным дистрибьютором и эксклюзивным представителем в России производителя высокотехнологичных и надежных решений для передачи СВЧ сигналов «FORSTAR».



JONHON

«JONHON» (основан в 1970 г.)

Разъемы специального, военного и аэрокосмического назначения:

(Применяются в военной, авиационной, аэрокосмической, морской, железнодорожной, горно- и нефтедобывающей отраслях промышленности)

«FORSTAR» (основан в 1998 г.)

ВЧ соединители, коаксиальные кабели, кабельные сборки и микроволновые компоненты:

(Применяются в телекоммуникациях гражданского и специального назначения, в средствах связи, РЛС, а так же военной, авиационной и аэрокосмической отраслях промышленности).



Телефон: 8 (812) 309-75-97 (многоканальный)

Факс: 8 (812) 320-03-32

Электронная почта: ocean@oceanchips.ru

Web: <http://oceanchips.ru/>

Адрес: 198099, г. Санкт-Петербург, ул. Калинина, д. 2, корп. 4, лит. А