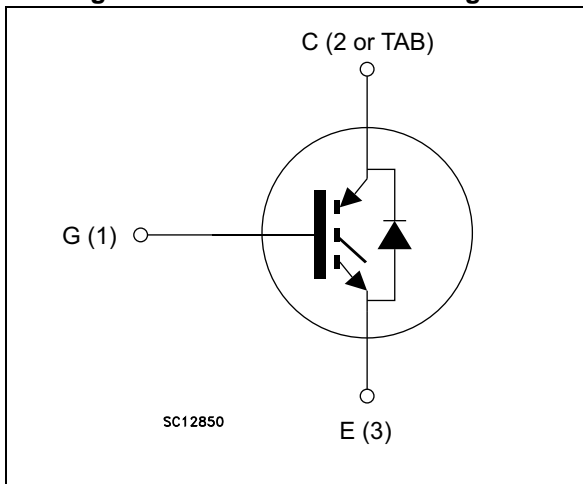

Figure 1. Internal schematic diagram



Features

- 10 μ s of short-circuit withstand time
- $V_{CE(sat)} = 1.55$ V (typ.) @ $I_C = 15$ A
- Tight parameter distribution
- Safer paralleling
- Low thermal resistance
- Soft and fast recovery antiparallel diode

Applications

- Industrial drives
- UPS
- Solar
- Welding

Description

This device is an IGBT developed using an advanced proprietary trench gate field-stop structure. The device is part of the S series of 1200 V IGBTs which is tailored to maximize efficiency of low frequency industrial systems. Furthermore, a positive $V_{CE(sat)}$ temperature coefficient and tight parameter distribution result in safer paralleling operation.

Table 1. Device summary

Order code	Marking	Package	Packing
STGW15S120DF3	G15S120DF3	TO-247	Tube
STGWA15S120DF3	G15S120DF3	TO-247 long leads	Tube

Contents

1	Electrical ratings	3
2	Electrical characteristics	4
3	Electrical characteristics curves	6
4	Test circuits	12
5	Package information	13
5.1	TO-247, STGW15S120DF3	13
5.2	TO-247 long leads, STGWA15S120DF3	15
6	Revision history	17

1 Electrical ratings

Table 2. Absolute maximum ratings

Symbol	Parameter	Value	Unit
V_{CES}	Collector-emitter voltage ($V_{GE} = 0$)	1200	V
I_C	Continuous collector current at $T_C = 25\text{ °C}$	30	A
I_C	Continuous collector current at $T_C = 100\text{ °C}$	15	A
$I_{CP}^{(1)}$	Pulsed collector current	60	A
V_{GE}	Gate-emitter voltage	± 20	V
I_F	Continuous forward current at $T_C = 25\text{ °C}$	30	A
I_F	Continuous forward current at $T_C = 100\text{ °C}$	15	A
$I_{FP}^{(1)}$	Pulsed forward current	60	A
P_{TOT}	Total dissipation at $T_C = 25\text{ °C}$	259	W
T_{STG}	Storage temperature range	- 55 to 150	°C
T_J	Operating junction temperature	- 55 to 175	°C

1. Pulse width limited by maximum junction temperature.

Table 3. Thermal data

Symbol	Parameter	Value	Unit
R_{thJC}	Thermal resistance junction-case IGBT	0.58	°C/W
R_{thJC}	Thermal resistance junction-case diode	1.3	°C/W
R_{thJA}	Thermal resistance junction-ambient	50	°C/W

2 Electrical characteristics

$T_J = 25\text{ °C}$ unless otherwise specified

Table 4. Static characteristics

Symbol	Parameter	Test conditions	Min.	Typ.	Max.	Unit
$V_{(BR)CES}$	Collector-emitter breakdown voltage ($V_{GE} = 0$)	$I_C = 2\text{ mA}$	1200			V
$V_{CE(sat)}$	Collector-emitter saturation voltage	$V_{GE} = 15\text{ V}, I_C = 15\text{ A}$		1.55	2.05	V
		$V_{GE} = 15\text{ V}, I_C = 15\text{ A}, T_J = 125\text{ °C}$		1.75		
		$V_{GE} = 15\text{ V}, I_C = 15\text{ A}, T_J = 175\text{ °C}$		1.85		
V_F	Forward on-voltage	$I_F = 15\text{ A}$		2.7	3.8	V
		$I_F = 15\text{ A}, T_J = 125\text{ °C}$		2.05		V
		$I_F = 15\text{ A}, T_J = 175\text{ °C}$		1.75		V
$V_{GE(th)}$	Gate threshold voltage	$V_{CE} = V_{GE}, I_C = 500\text{ }\mu\text{A}$	5	6	7	V
I_{CES}	Collector cut-off current ($V_{GE} = 0$)	$V_{CE} = 1200\text{ V}$			25	μA
I_{GES}	Gate-emitter leakage current ($V_{CE} = 0$)	$V_{GE} = \pm 20\text{ V}$			250	nA

Table 5. Dynamic characteristics

Symbol	Parameter	Test conditions	Min.	Typ.	Max.	Unit
C_{ies}	Input capacitance	$V_{CE} = 25\text{ V}, f = 1\text{ MHz}, V_{GE} = 0$	-	981	-	pF
C_{oes}	Output capacitance		-	82	-	pF
C_{res}	Reverse transfer capacitance		-	37	-	pF
Q_g	Total gate charge	$V_{CC} = 960\text{ V}, I_C = 15\text{ A}, V_{GE} = 15\text{ V},$ see Figure 30	-	53	-	nC
Q_{ge}	Gate-emitter charge		-	7.8	-	nC
Q_{gc}	Gate-collector charge		-	28.2	-	nC

Table 6. IGBT switching characteristics (inductive load)

Symbol	Parameter	Test conditions	Min.	Typ.	Max.	Unit
$t_{d(on)}$	Turn-on delay time	$V_{CE} = 600\text{ V}$, $I_C = 15\text{ A}$, $V_{GE} = 15\text{ V}$, $R_G = 22\ \Omega$ see Figure 29	-	23	-	ns
t_r	Current rise time		-	10	-	ns
$(di/dt)_{on}$	Turn-on current slope		-	1200	-	A/ μ s
$t_{d(off)}$	Turn-off delay time		-	140	-	ns
t_f	Current fall time		-	282	-	ns
$E_{on}^{(1)}$	Turn-on switching losses		-	0.54	-	mJ
$E_{off}^{(2)}$	Turn-off switching losses		-	1.375	-	mJ
E_{ts}	Total switching losses	-	1.912	-	mJ	
$t_{d(on)}$	Turn-on delay time	$V_{CE} = 600\text{ V}$, $I_C = 15\text{ A}$, $R_G = 22\ \Omega$, $V_{GE} = 15\text{ V}$, $T_J = 175\text{ }^\circ\text{C}$, see Figure 29	-	22	-	ns
t_r	Current rise time		-	9.2	-	ns
$(di/dt)_{on}$	Turn-on current slope		-	983	-	A/ μ s
$t_{d(off)}$	Turn-off delay time		-	146	-	ns
t_f	Current fall time		-	438	-	ns
$E_{on}^{(1)}$	Turn-on switching losses		-	0.923	-	mJ
$E_{off}^{(2)}$	Turn-off switching losses		-	1.85	-	mJ
E_{ts}	Total switching losses	-	2.772	-	mJ	
t_{sc}	Short-circuit withstand time	$V_{CC} \leq 600\text{ V}$, $V_{GE} = 15\text{ V}$, $T_{Jstart} \leq 150\text{ }^\circ\text{C}$, $V_P < 1200\text{ V}$	10		-	μ s

1. Energy losses include reverse recovery of the diode.
2. Turn-off losses also include the tail of the collector current.

Table 7. Diode switching characteristics (inductive load)

Symbol	Parameter	Test conditions	Min.	Typ.	Max.	Unit
t_{rr}	Reverse recovery time	$I_F = 15\text{ A}$, $V_R = 600\text{ V}$, $V_{GE} = 15\text{ V}$, see Figure 29 $di/dt = 1000\text{ A}/\mu\text{s}$	-	270	-	ns
Q_{rr}	Reverse recovery charge		-	960	-	nC
I_{rrm}	Reverse recovery current		-	15	-	A
dl_{rr}/dt	Peak rate of fall of reverse recovery current during t_b		-	935	-	A/ μ s
E_{rr}	Reverse recovery energy		-	0.18	-	mJ
t_{rr}	Reverse recovery time	$I_F = 15\text{ A}$, $V_R = 600\text{ V}$, $V_{GE} = 15\text{ V}$, $T_J = 175\text{ }^\circ\text{C}$, see Figure 29 $di/dt = 1000\text{ A}/\mu\text{s}$	-	534	-	ns
Q_{rr}	Reverse recovery charge		-	3456	-	nC
I_{rrm}	Reverse recovery current		-	23	-	A
dl_{rr}/dt	Peak rate of fall of reverse recovery current during t_b		-	266	-	A/ μ s
E_{rr}	Reverse recovery energy		-	0.55	-	mJ

3 Electrical characteristics curves

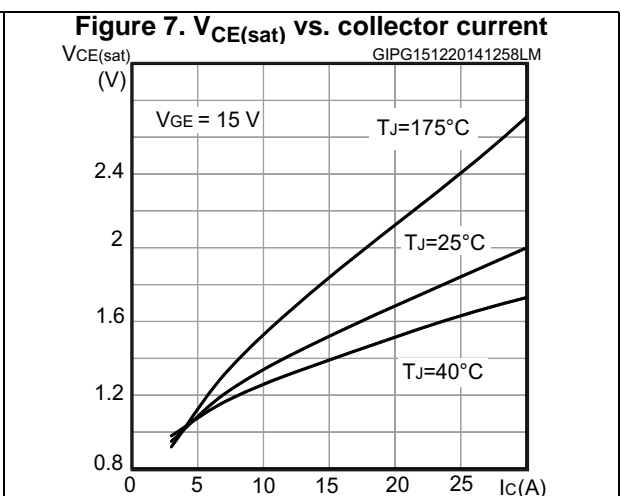
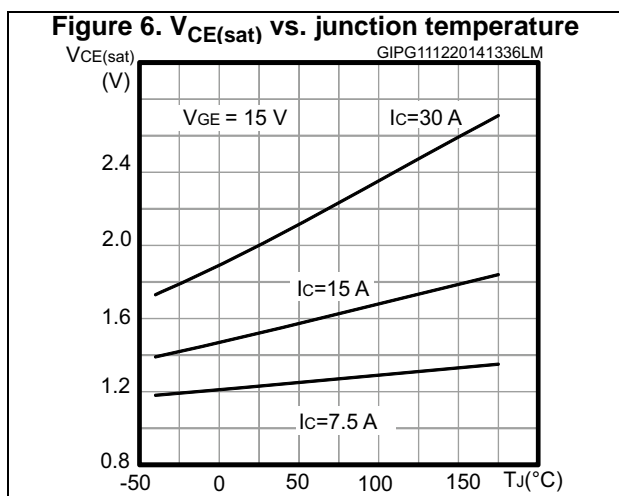
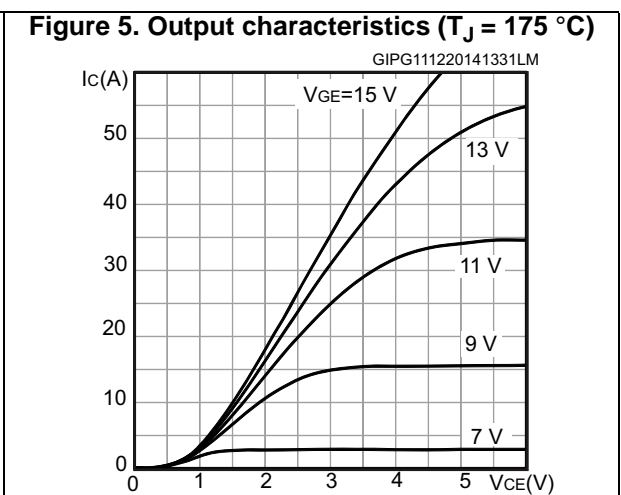
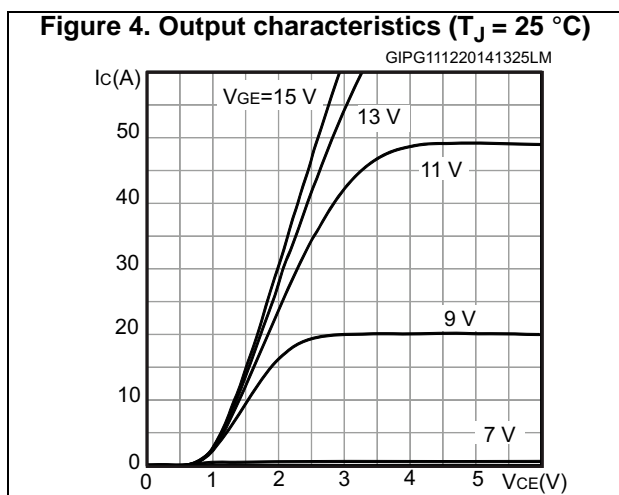
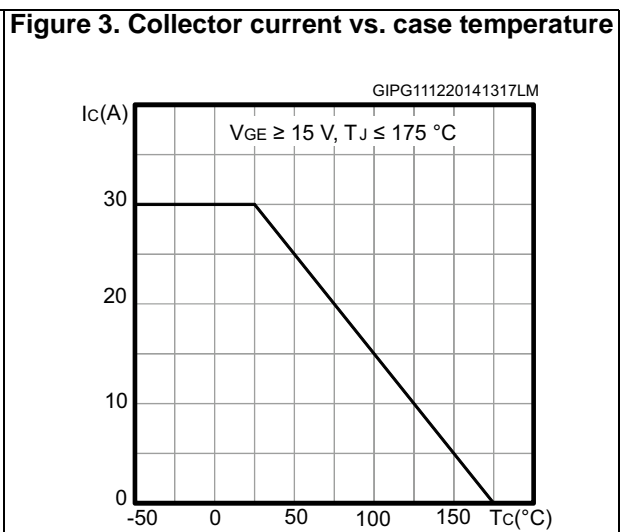
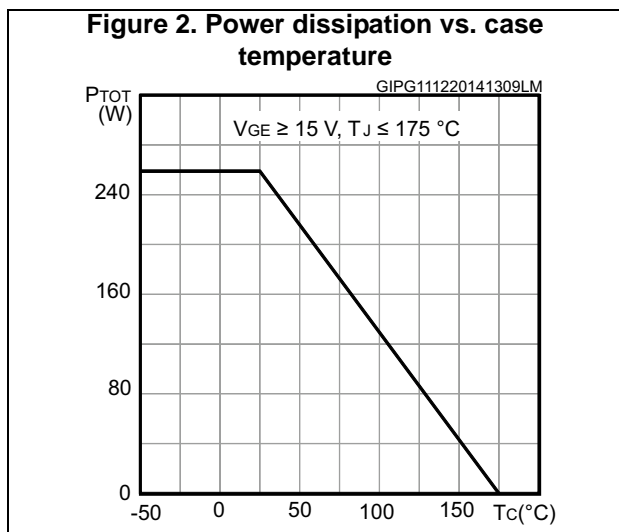

Figure 8. Collector current vs. switching frequency

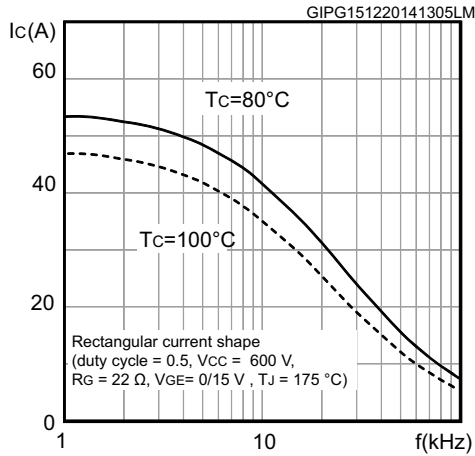

Figure 9. Forward bias safe operating area

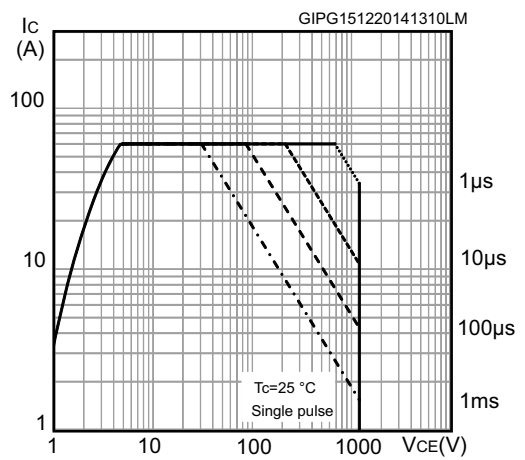

Figure 10. Transfer characteristics

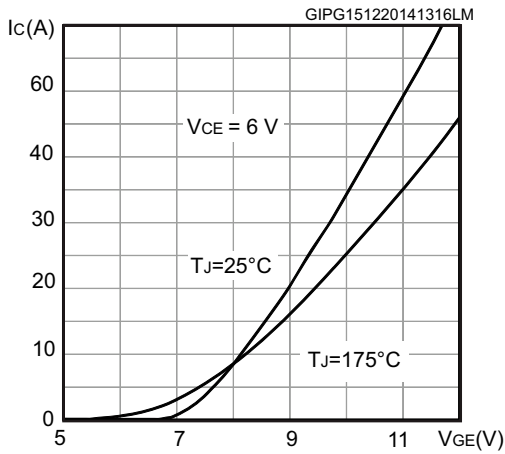

Figure 11. Diode V_F vs. forward current

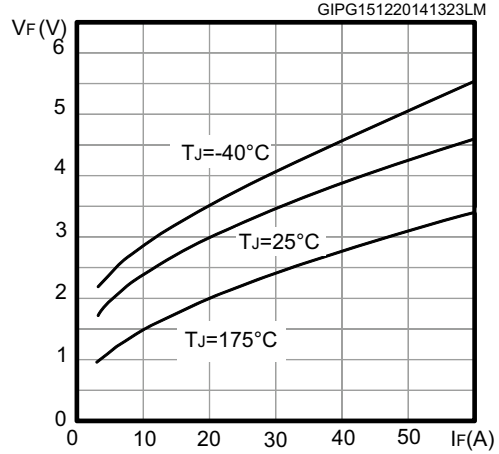

Figure 12. Normalized $V_{GE(th)}$ vs. junction temperature

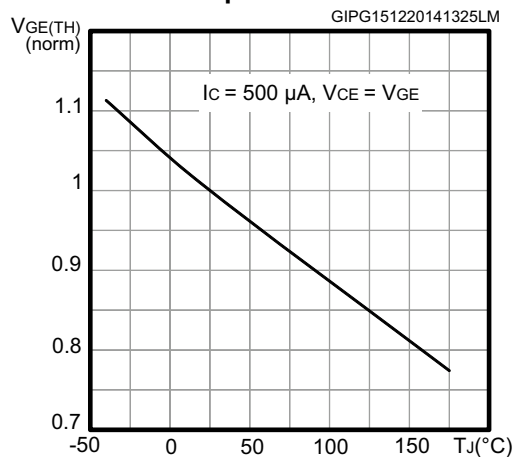
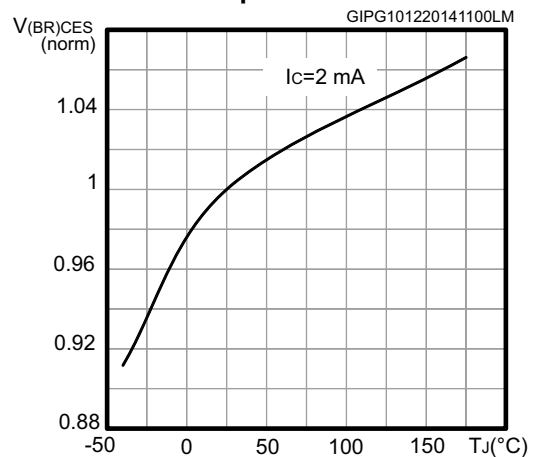

Figure 13. Normalized $V_{BR(CES)}$ vs. junction temperature



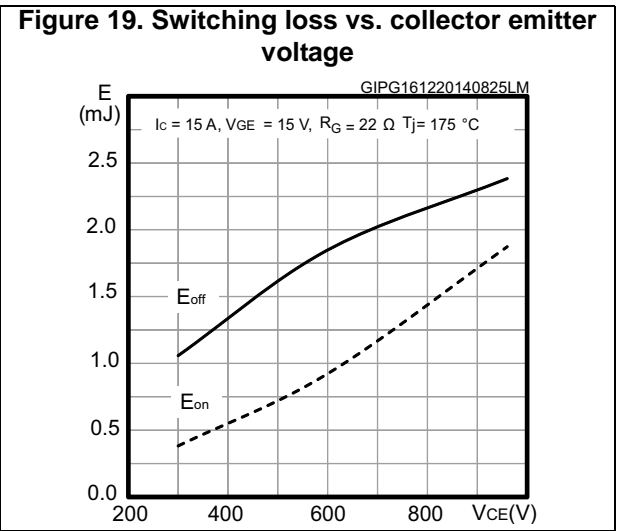
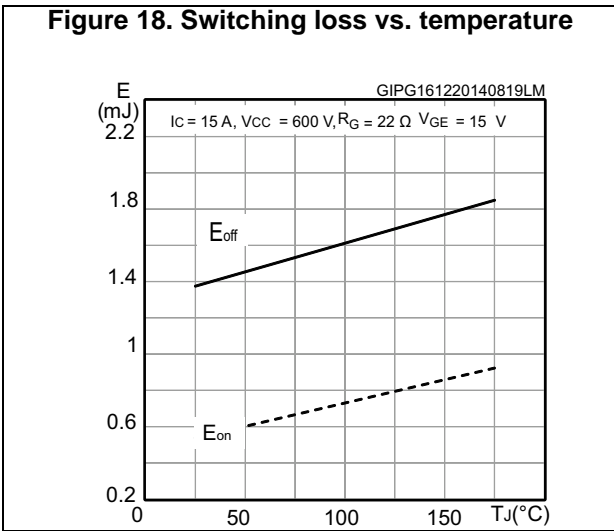
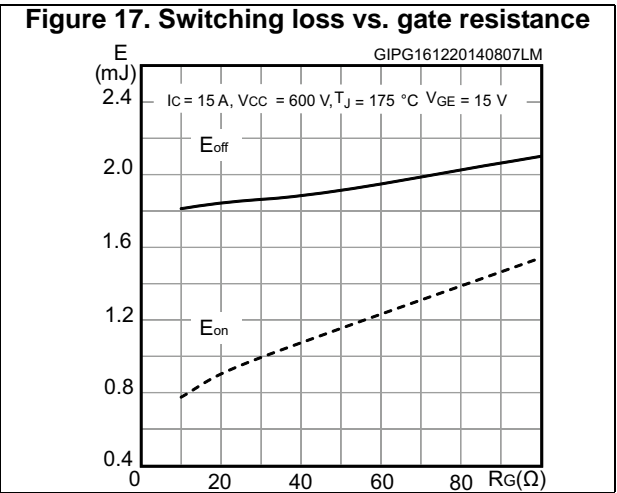
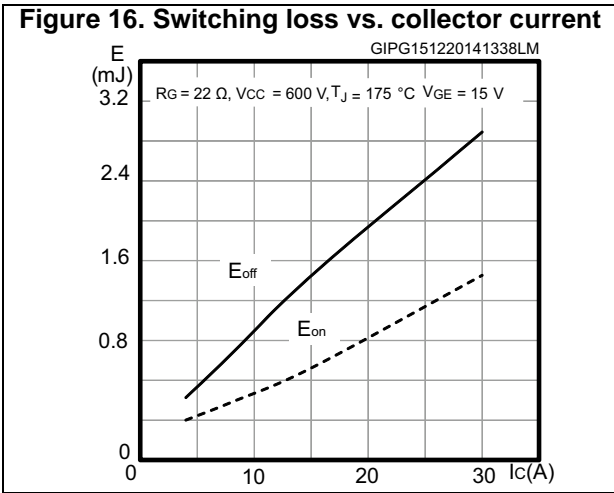
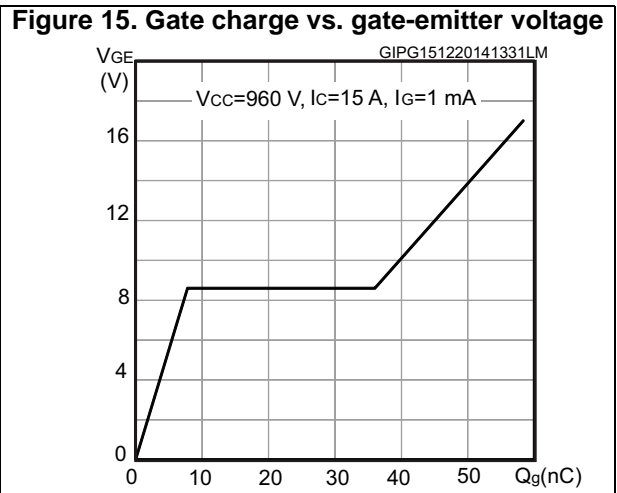
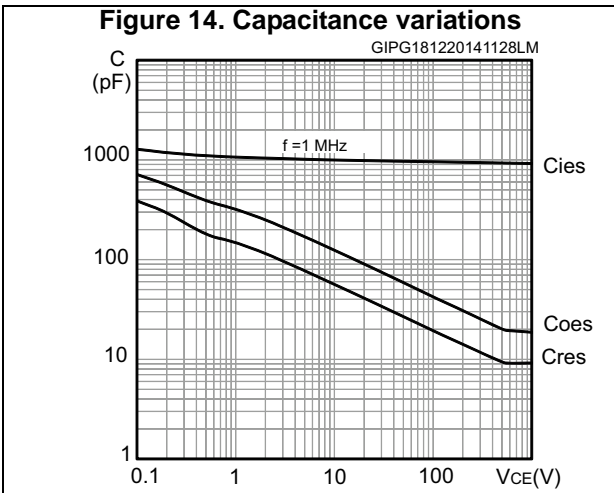

Figure 20. Short-circuit time and current vs V_{GE}

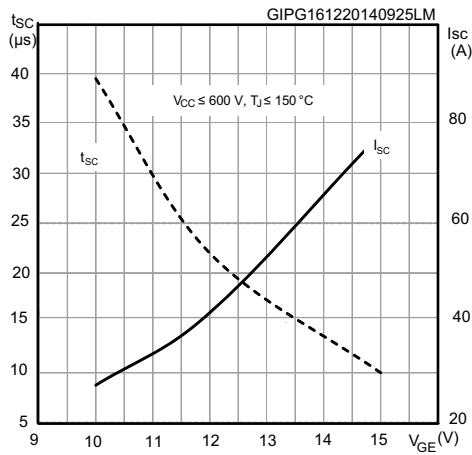

Figure 21. Switching times vs. collector current

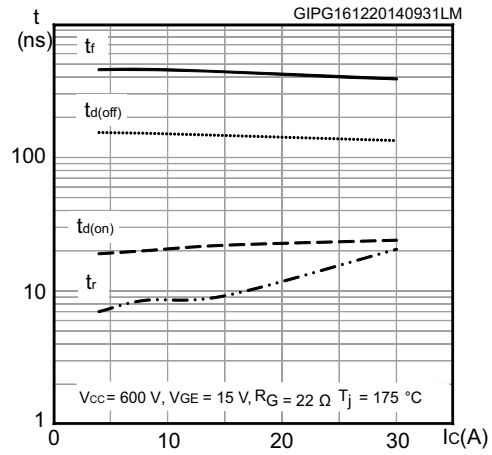

Figure 22. Switching times vs. gate resistance

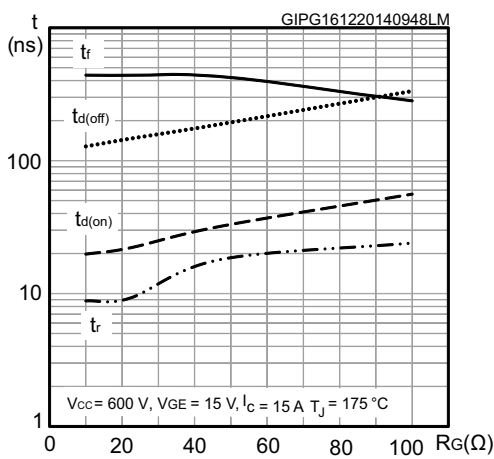

Figure 23. Reverse recovery current vs. diode current slope

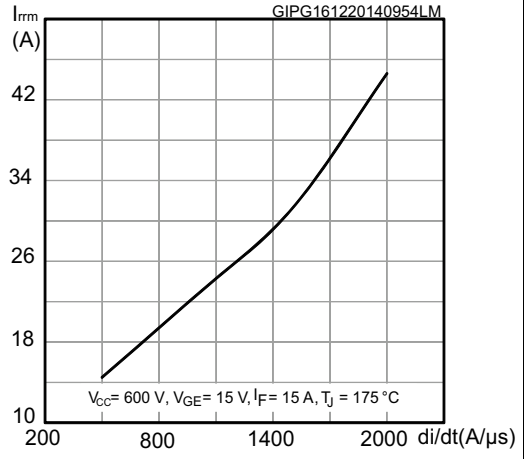

Figure 24. Reverse recovery time vs. diode current slope

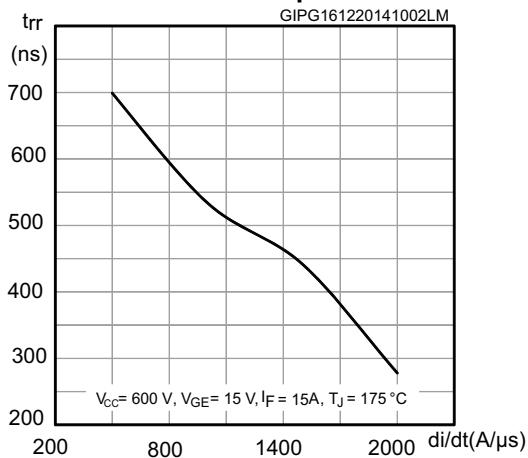
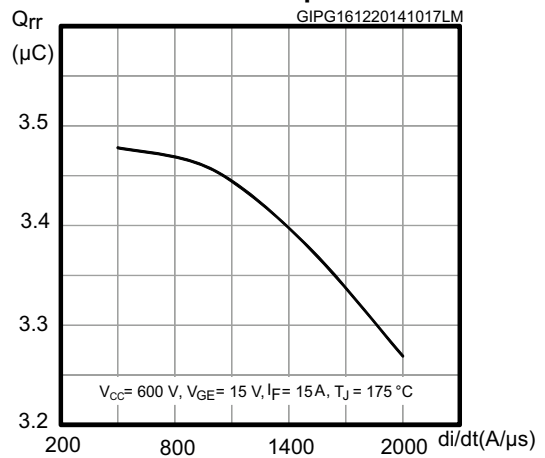

Figure 25. Reverse recovery charge vs. diode current slope



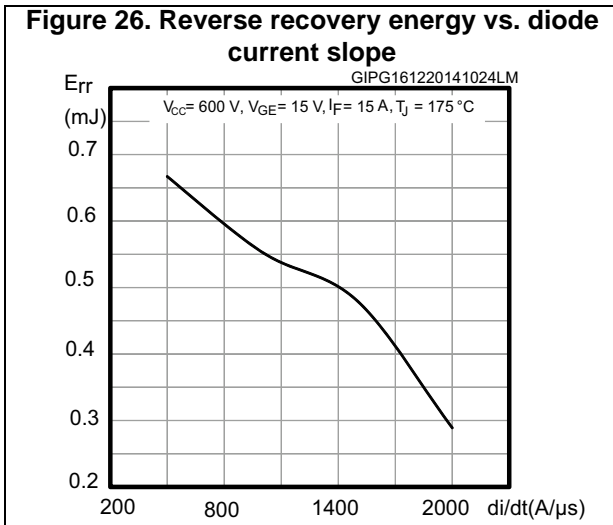

Figure 27. Thermal impedance for IGBT

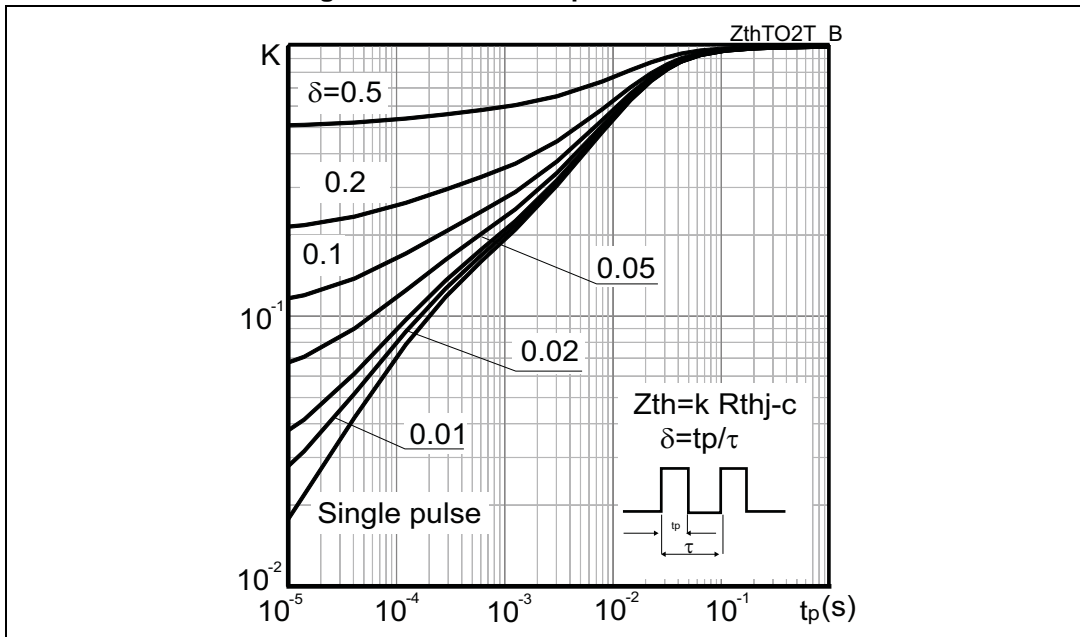
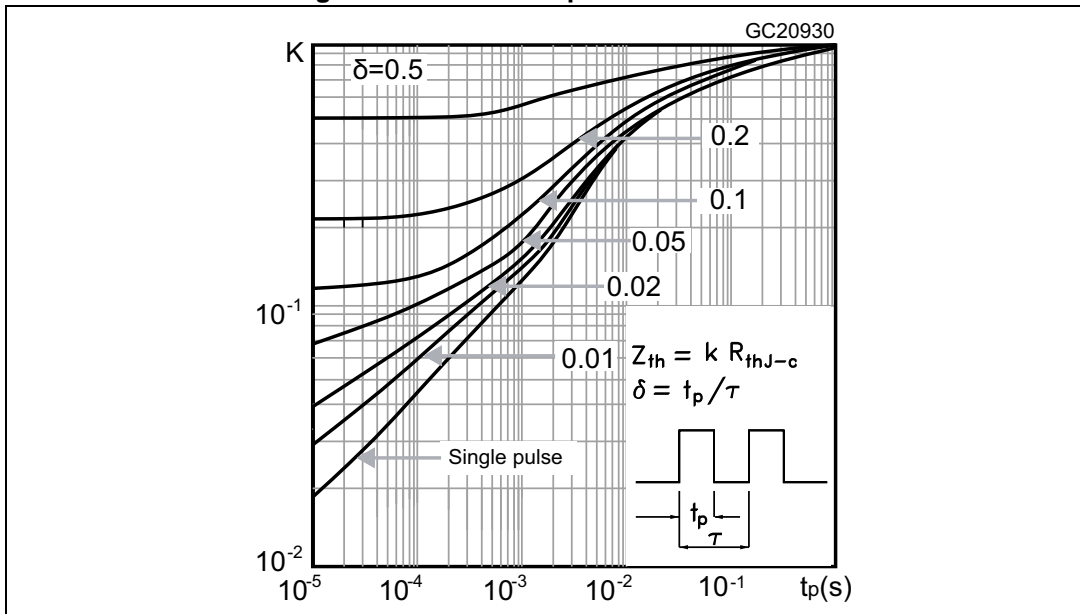
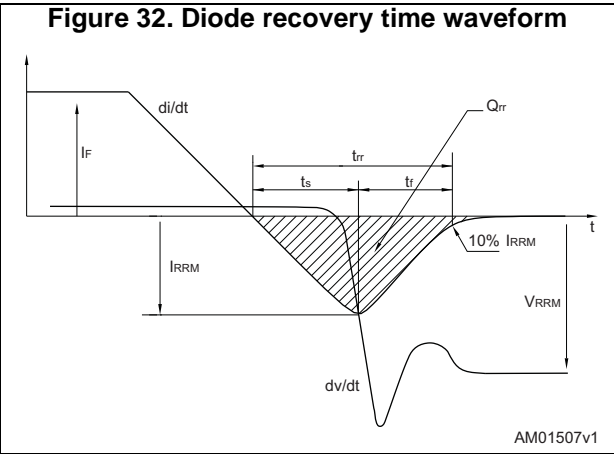
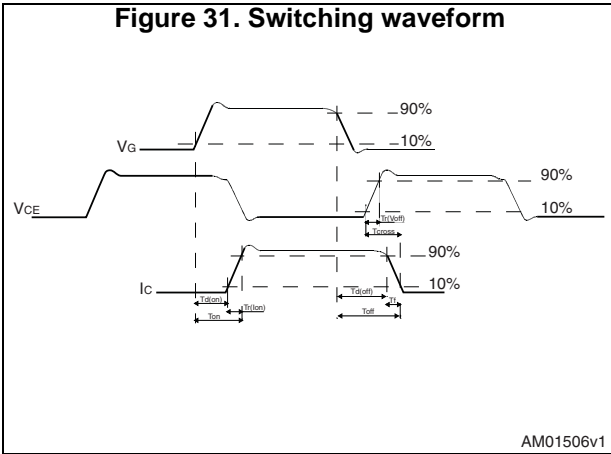
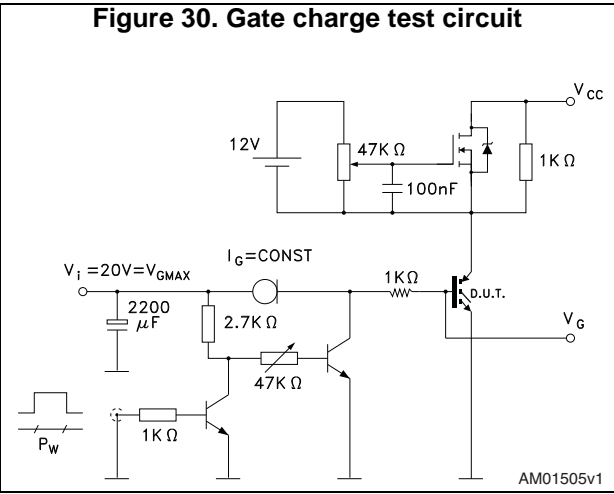
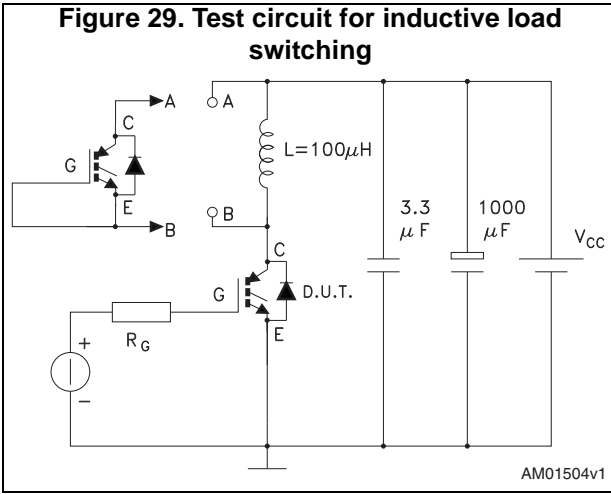

Figure 28. Thermal impedance for diode



4 Test circuits



5 Package information

In order to meet environmental requirements, ST offers these devices in different grades of ECOPACK® packages, depending on their level of environmental compliance. ECOPACK® specifications, grade definitions and product status are available at: www.st.com. ECOPACK is an ST trademark.

5.1 TO-247, STGW15S120DF3

Figure 33. TO-247 outline

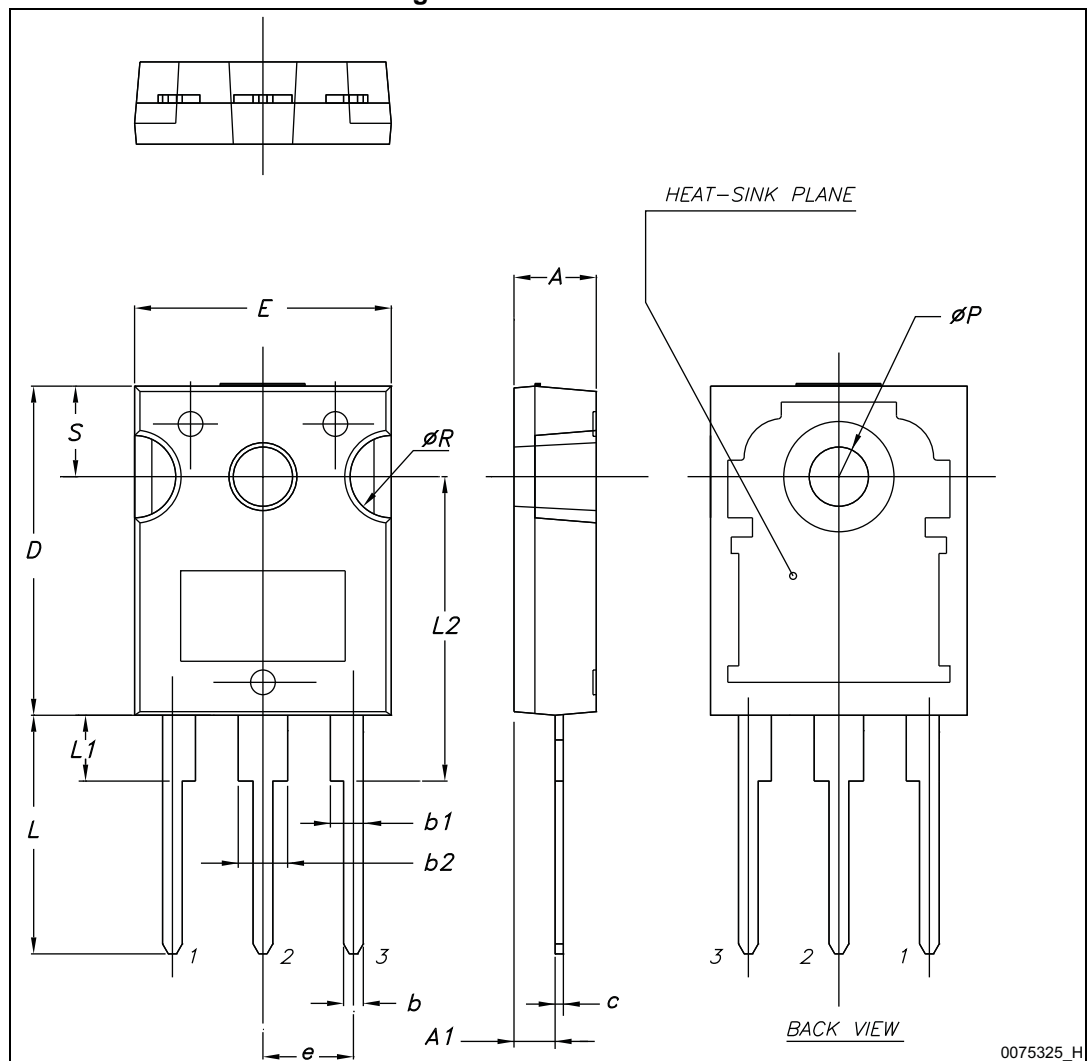

Table 8. TO-247 mechanical data

Dim.	mm		
	Min.	Typ.	Max.
A	4.85		5.15
A1	2.20		2.60
b	1.0		1.40
b1	2.0		2.40
b2	3.0		3.40
c	0.40		0.80
D	19.85		20.15
E	15.45		15.75
e	5.30	5.45	5.60
L	14.20		14.80
L1	3.70		4.30
L2		18.50	
ØP	3.55		3.65
ØR	4.50		5.50
S	5.30	5.50	5.70

5.2 TO-247 long leads, STGWA15S120DF3

Figure 34. TO-247 long lead outline

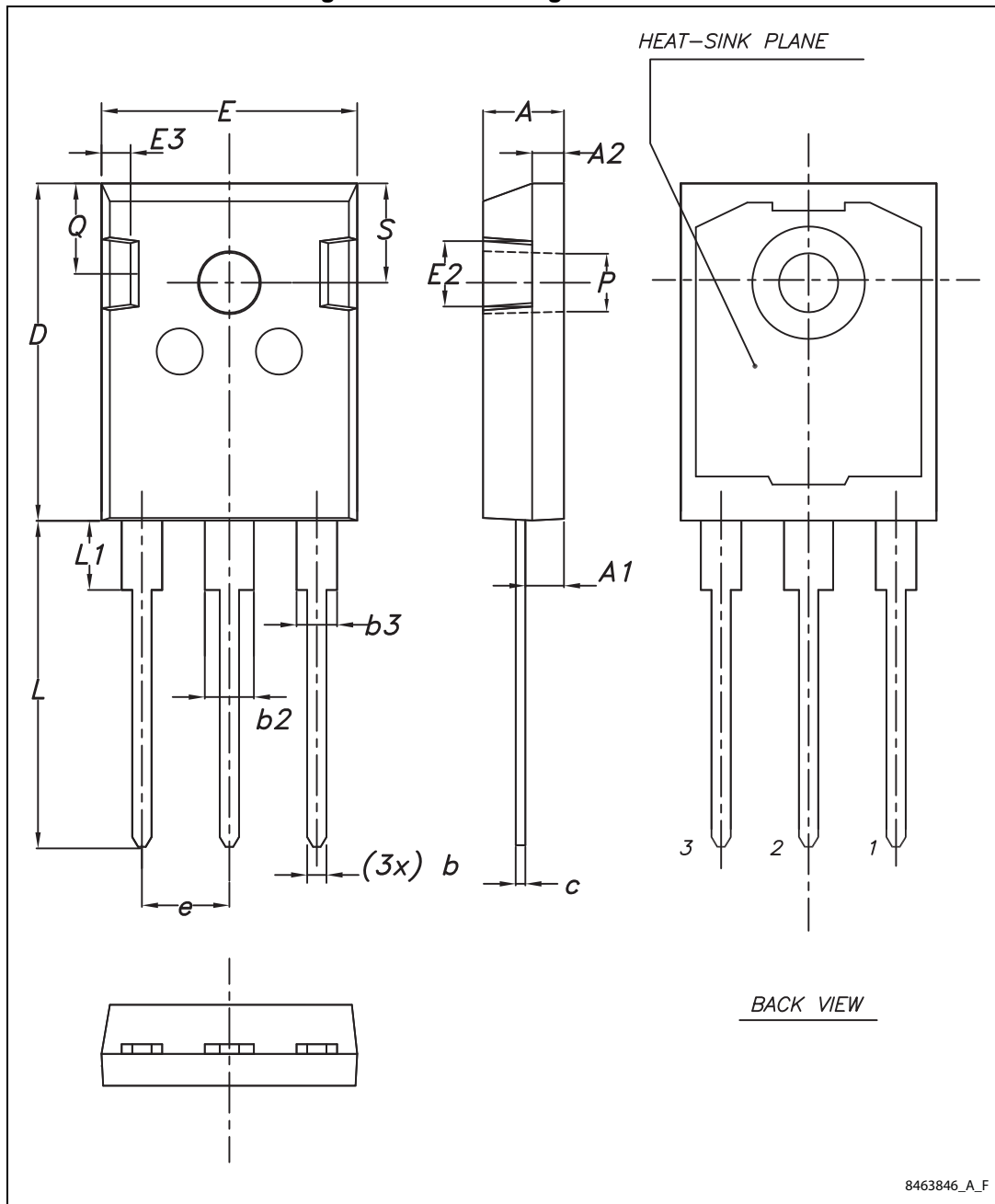

Table 9. TO-247 long leads mechanical data

Dim.	mm		
	Min.	Typ.	Max.
A	4.90	5.00	5.10
A1	2.31	2.41	2.51
A2	1.90	2.00	2.10
b	1.16		1.26
b2			3.25
b3			2.25
c	0.59		0.66
D	20.90	21.00	21.10
E	15.70	15.80	15.90
E2	4.90	5.00	5.10
E3	2.40	2.50	2.60
e	5.34	5.44	5.54
L	19.80	19.92	20.10
L1			4.30
P	3.50	3.60	3.70
Q	5.60		6.00
S	6.05	6.15	6.25

6 Revision history

Table 10. Document revision history

Date	Revision	Changes
16-May-2014	1	Initial release.
18-Dec-2014	2	Updated Section 1 and Section 2 . Inserted Section 3 .

IMPORTANT NOTICE – PLEASE READ CAREFULLY

STMicroelectronics NV and its subsidiaries ("ST") reserve the right to make changes, corrections, enhancements, modifications, and improvements to ST products and/or to this document at any time without notice. Purchasers should obtain the latest relevant information on ST products before placing orders. ST products are sold pursuant to ST's terms and conditions of sale in place at the time of order acknowledgement.

Purchasers are solely responsible for the choice, selection, and use of ST products and ST assumes no liability for application assistance or the design of Purchasers' products.

No license, express or implied, to any intellectual property right is granted by ST herein.

Resale of ST products with provisions different from the information set forth herein shall void any warranty granted by ST for such product.

ST and the ST logo are trademarks of ST. All other product or service names are the property of their respective owners.

Information in this document supersedes and replaces information previously supplied in any prior versions of this document.

© 2014 STMicroelectronics – All rights reserved

Компания «Океан Электроники» предлагает заключение долгосрочных отношений при поставках импортных электронных компонентов на взаимовыгодных условиях!

Наши преимущества:

- Поставка оригинальных импортных электронных компонентов напрямую с производств Америки, Европы и Азии, а так же с крупнейших складов мира;
- Широкая линейка поставок активных и пассивных импортных электронных компонентов (более 30 млн. наименований);
- Поставка сложных, дефицитных, либо снятых с производства позиций;
- Оперативные сроки поставки под заказ (от 5 рабочих дней);
- Экспресс доставка в любую точку России;
- Помощь Конструкторского Отдела и консультации квалифицированных инженеров;
- Техническая поддержка проекта, помощь в подборе аналогов, поставка прототипов;
- Поставка электронных компонентов под контролем ВП;
- Система менеджмента качества сертифицирована по Международному стандарту ISO 9001;
- При необходимости вся продукция военного и аэрокосмического назначения проходит испытания и сертификацию в лаборатории (по согласованию с заказчиком);
- Поставка специализированных компонентов военного и аэрокосмического уровня качества (Xilinx, Altera, Analog Devices, Intersil, Interpoint, Microsemi, Actel, Aeroflex, Peregrine, VPT, Syfer, Eurofarad, Texas Instruments, MS Kennedy, Miteq, Cobham, E2V, MA-COM, Hittite, Mini-Circuits, General Dynamics и др.);

Компания «Океан Электроники» является официальным дистрибьютором и эксклюзивным представителем в России одного из крупнейших производителей разъемов военного и аэрокосмического назначения «JONHON», а так же официальным дистрибьютором и эксклюзивным представителем в России производителя высокотехнологичных и надежных решений для передачи СВЧ сигналов «FORSTAR».



JONHON

«JONHON» (основан в 1970 г.)

Разъемы специального, военного и аэрокосмического назначения:

(Применяются в военной, авиационной, аэрокосмической, морской, железнодорожной, горно- и нефтедобывающей отраслях промышленности)

«FORSTAR» (основан в 1998 г.)

ВЧ соединители, коаксиальные кабели,
кабельные сборки и микроволновые компоненты:

(Применяются в телекоммуникациях гражданского и специального назначения, в средствах связи, РЛС, а так же военной, авиационной и аэрокосмической отраслях промышленности).



Телефон: 8 (812) 309-75-97 (многоканальный)

Факс: 8 (812) 320-03-32

Электронная почта: ocean@oceanchips.ru

Web: <http://oceanchips.ru/>

Адрес: 198099, г. Санкт-Петербург, ул. Калинина, д. 2, корп. 4, лит. А