

A3C

Pushbutton Switch (Lighted/Non-Lighted) (Cylindrical 12-dia.)

CSM_A3C_DS_E_2_1

Pushbutton Switch Series with Cylindrical 20-mm × 12-dia. Body

- High-intensity uniform surface lighting.
- Round body enables easy hole making.
- Miniature size with excellent feeling of operation.

RoHS Compliant

⚠ Refer to *Safety Precautions for All Pushbutton Switches* and *Safety Precautions* on page 12.

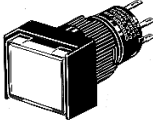
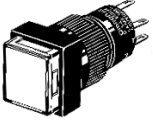
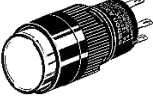

List of Models

Appearance	Model
Rectangular Models 	A3CJ
Square Models 	A3CA
Round Models 	A3CT

■ Specifications: Refer to page 8. ■ Dimensions: Refer to page 10. ■ Accessories: Refer to page 7.
■ Precautions for correct use and safety precautions: Refer to page 12.

Model Number LegendWhen placing your order, specify the individual component part model numbers of the Pushbutton, Lamp (lighted models only), and Switch, as listed in the ordering tables below.

For information on combinations, refer to *Ordering Information* on page 3.

(1) (2) (3) (4) (5) (6)

A 3 C J - 9 0 A 1 - 2 4 E R

(1) Shape of Pushbutton

Symbol	Shape
J	Rectangular
A	Square
T	Round

(2) Terminal Type

Symbol	Type
0	Solder terminal

(3) Switch Specifications Standard Load

Symbol	Operation	
A	Momentary	1a1b
B	Alternate	

Microload

Symbol	Operation	
E	Momentary	1a1b
F	Alternate	

- Standard Load
0.5 A at 250 VAC
1 A at 125 VAC
1 A at 30 VDC
- Microload
0.1 A at 125 VAC
0.1 A at 30 VDC

Minimum applicable load
1 mA at 5 VDC

Momentary-action: Self-resetting
Alternate-action: Self-holding

(4) Lighted/Non-lighted

Symbol	Type
0	Non-lighted
1	Illumination only

- Colored-illumination models are also available. Refer to page 4.

► "Colored-illumination" models operate in the way shown below:

Unlit	Lit
White	Color

The built-in LED is colored.

(5) Lighting Method LED Lamp-lighted Models

Symbol	Operating voltage
05E	5 VDC
12E	12 VDC
24E	24 VDC

Incandescent Lamp-lighted Models

Symbol	Operating voltage
06	5 VAC/VDC
14	12 VAC/VDC
28	24 VAC/VDC

(6) Color of Pushbutton For LED Lamp

Symbol	Color
R	Red
Y	Yellow
G	Green
W	White

For Incandescent Lamp

Symbol	Color
R	Red
Y	Yellow
G	Green
A	Blue
W	White

Non-lighted Models

No symbol

For Non-lighted Models

Symbol	Color
R	Red
Y	Yellow
G	Green
W	White
A	Blue
B	Black

Ordering Information

Ordering as a Set The model numbers used to order sets of Units are given in the following tables. One set comprises the Pushbutton, Lamp (lighted models only), and Switch.

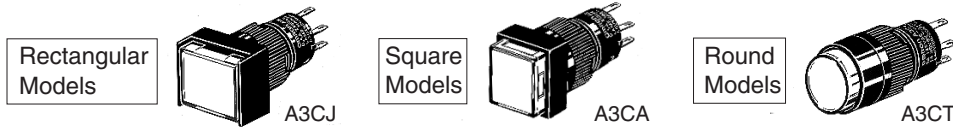

Lighted Pushbutton Switches (SPST-NO+SPST-NC Solder Terminals)

Shape	Operation Lighting	Standard load		Microload	Pushbutton color symbol (Color)
		Momentary operation (Self-resetting)	Alternate operation (Self-holding)	Momentary operation (Self-resetting)	
		Set	Set	Set	
Rectangular (A3CJ)	LED lamp	A3CJ-90A1-05E□	A3CJ-90B1-05E□	A3CJ-90E1-05E□	R: red Y: yellow G: green W: white
		A3CJ-90A1-12E□	A3CJ-90B1-12E□	A3CJ-90E1-12E□	
		A3CJ-90A1-24E□	A3CJ-90B1-24E□	A3CJ-90E1-24E□	
	Incandescent lamp	A3CJ-90A1-06□	---	---	R: red Y: yellow G: green W: white A: blue B: black *
		A3CJ-90A1-14□			
		A3CJ-90A1-28□	A3CJ-90B1-28□		
Non-lighted	A3CJ-90A0-□	A3CJ-90B0-□	A3CJ-90E0-□		
Square (A3CA)	LED lamp	A3CA-90A1-05E□	A3CA-90B1-05E□	A3CA-90E1-05E□	R: red Y: yellow G: green W: white
		A3CA-90A1-12E□	A3CA-90B1-12E□	A3CA-90E1-12E□	
		A3CA-90A1-24E□	A3CA-90B1-24E□	A3CA-90E1-24E□	
	Incandescent lamp	A3CA-90A1-06□	---	---	R: red Y: yellow G: green W: white A: blue B: black *
		A3CA-90A1-14□			
		A3CA-90A1-28□	A3CA-90B1-28□		
Non-lighted	A3CA-90A0-□	A3CA-90B0-□	A3CA-90E0-□		
Round (A3CT)	LED lamp	A3CT-90A1-05E□	A3CT-90B1-05E□	A3CT-90E1-05E□	R: red Y: yellow G: green W: white
		A3CT-90A1-12E□	A3CT-90B1-12E□	A3CT-90E1-12E□	
		A3CT-90A1-24E□	A3CT-90B1-24E□	A3CT-90E1-24E□	
	Incandescent lamp	A3CT-90A1-06□	---	---	R: red Y: yellow G: green W: white A: blue B: black *
		A3CT-90A1-14□			
		A3CT-90A1-28□	A3CT-90B1-28□		
Non-lighted	A3CT-90A0-□	A3CT-90B0-□	A3CT-90E0-□		

Note: 1. Enter the desired color symbol for the Pushbutton in the □ at the end of the model number.
 2. There are also alternate-operation models that can be used for microloads. Refer to the Switch table on page 6.
 * Black ("B") Pushbuttons are only available for non-lighted models.

Individual models: Refer to pages 5 to 6.
 (The Pushbutton, Lamp, and Switch can be ordered separately.)

■ Specifications: Refer to page 8. ■ Dimensions: Refer to page 10.
 ■ Accessories: Refer to page 7.

Ordering Information

Illumination-only and Colored-illumination LED Models

"Illumination only" describes LED models for which the screen color is the same whether the LED is lit or not.

Example: Red LED

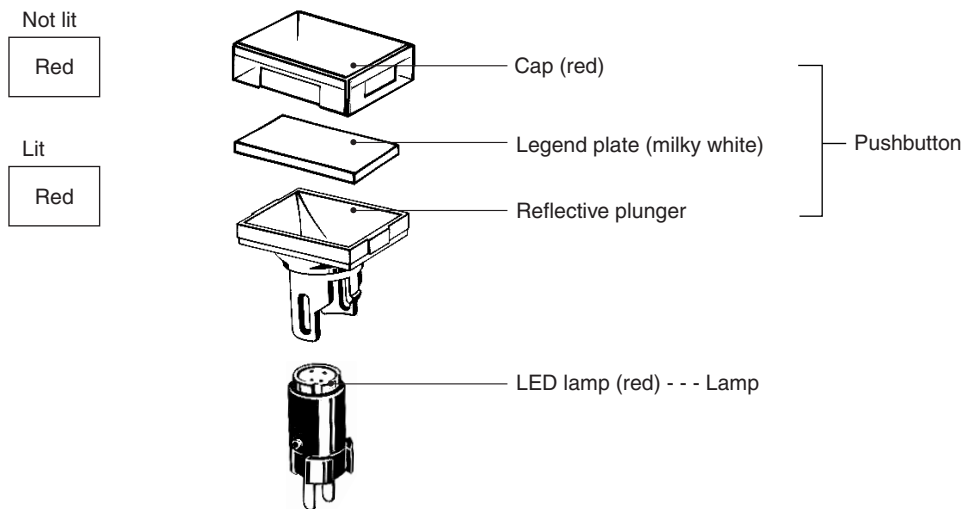

"Colored illumination" describes LED models for which the screen color is white when the LED is not lit and changes to the color of the LED lamp when the LED is lit.

Example: Red LED

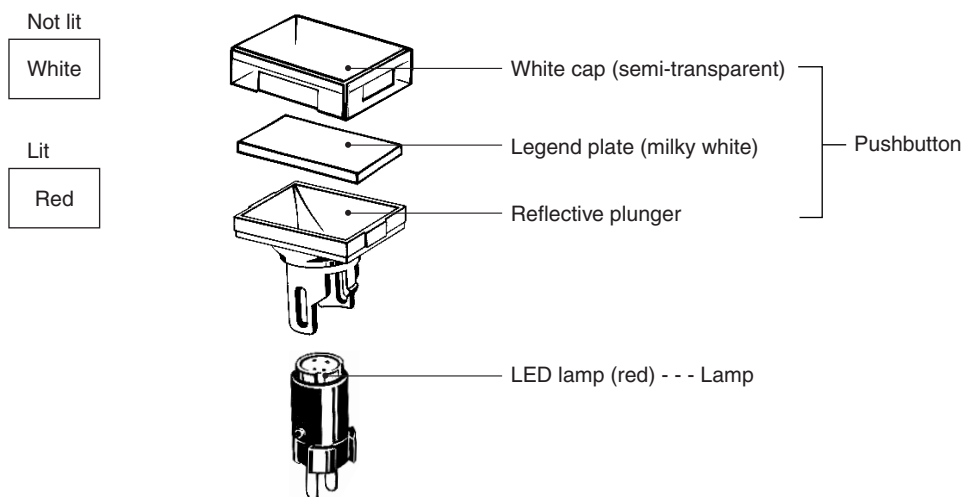

Ordering: With colored-illumination models, order the Pushbutton, Lamp, and Switch as shown in the following table.

Illuminated color	Pushbutton	Lamp (LED)	Switch
Red	IP40 A3C□-500W Enter one of the following symbols in □. J: Rectangular A: Square T: Round	A16-□DR	Enter one of the following symbols in □. 5: 5 VDC 12: 12 VDC 24: 24 VDC
Yellow		A16-□DY	
Green		A16-□DG	

Ordering Information

Ordering Individually Pushbuttons, Lamps, and Switches can be ordered separately. Combinations that are not available as sets can be created using individual Units. Also, store the parts as spares for maintenance and repairs.

Ordering: Specify a model number from the following page.

LED Lamp

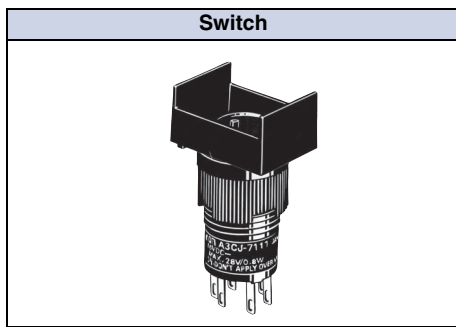
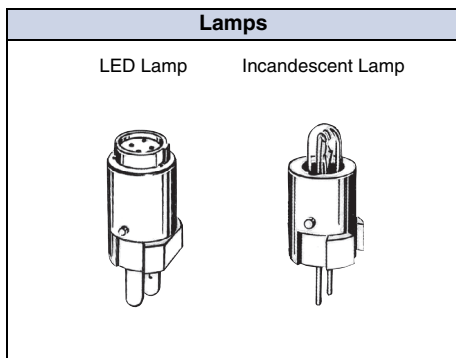
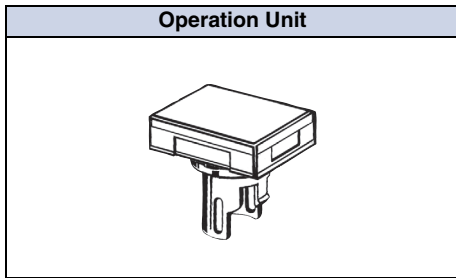

Non-lighted Models

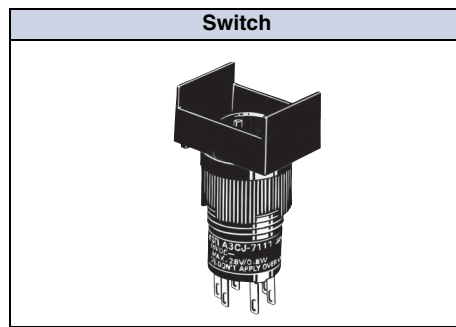
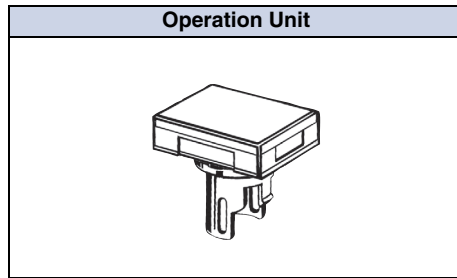

Ordering set combinations: Refer to page 3.



■ Specifications: Refer to page 8. ■ Dimensions: Refer to page 10.
 ■ Accessories: Refer to page 7.

Ordering Information

Ordering Individually Pushbuttons, Lamps, and Switches can be ordered separately. Combinations that are not available as sets can be created using individual Units. Also, store the parts as spares for maintenance and repairs.



Pushbuttons

LED Lamp

Shape	Rectangular	Square	Round
Button color			
Red	A3CJ-500R	A3CA-500R	A3CT-500R
Yellow	A3CJ-500Y	A3CA-500Y	A3CT-500Y
Green	A3CJ-500GY	A3CA-500GY	A3CT-500GY
White	A3CJ-500W	A3CA-500W	A3CT-500W



Note: The red, yellow, and white Pushbuttons listed above can be used with either LED lamp-lighted models or incandescent lamp-lighted models.

Non-lighted Models

Shape	Rectangular	Square	Round
Button color			
Red	A3CJ-500R	A3CA-500R	A3CT-500R
Yellow	A3CJ-500Y	A3CA-500Y	A3CT-500Y
Green	A3CJ-500G	A3CA-500G	A3CT-500G
White	A3CJ-500W	A3CA-500W	A3CT-500W
Blue	A3CJ-500A	A3CA-500A	A3CT-500A
Black	A3CJ-501B	A3CA-501B	A3CT-501B

Note: Models other than black can also be used with incandescent lamps.

Incandescent Lamp

Shape	Rectangular	Square	Round
Button color			
Red	A3CJ-500R	A3CA-500R	A3CT-500R
Yellow	A3CJ-500Y	A3CA-500Y	A3CT-500Y
Green	A3CJ-500G	A3CA-500G	A3CT-500G
White	A3CJ-500W	A3CA-500W	A3CT-500W
Blue	A3CJ-500A	A3CA-500A	A3CT-500A

Lamps

LED Lamp

Color Rated voltage	Red	Yellow	Green	White
5 VDC	A16-5DR	A16-5DY	A16-5DG	A16-5DW
12 VDC	A16-12DR	A16-12DY	A16-12DG	A16-12DW
24 VDC	A16-24DR	A16-24DY	A16-24DG	A16-24DW

Incandescent Lamp

Rated voltage	Model
6 VAC/DC	A16-5
14 VAC/DC	A16-12
28 VAC/DC	A16-24

Switches

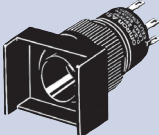
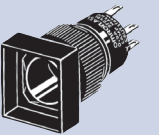
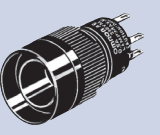
Sealing				Degree of protection: IP40		
Shape				Rectangular	Square	Round
Contact type						
Standard load	SPST-NO+ SPST NC	Momentary	Solder	A3CJ-7011	A3CA-7011	A3CT-7011
		Alternate		A3CJ-7021	A3CA-7021	A3CT-7021
Microload		Momentary	Solder	A3CJ-7111	A3CA-7111	A3CT-7111
		Alternate		A3CJ-7121	A3CA-7121	A3CT-7121



Ordering set combinations: Refer to page 3.

■ Specifications: Refer to page 8. ■ Dimensions: Refer to page 10.
■ Accessories: Refer to page 7.



Ordering Information

Accessories, Replacements, and Tools

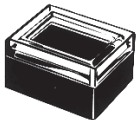
Accessories

Name	Appearance	Classification	Model	Remarks
Socket		Wire-wrap terminal	A3C-4101	Cannot be used with Insulation Cover.
		PCB terminal	A3C-4102	
		Solder terminal	A3C-4103	
Insulation Cover		---	A3C-3002	Cannot be used with Socket.
Switch Guard		For rectangular models	A3CJ-5050	Cannot be used with Dust Cover.
		For square, round models	A3CA-5050	
Dust Cover		For rectangular models	A3CJ-5060	Cannot be used with Switch Guard. Can be used with Dust Cover attached.

Tools

Name	Appearance	Classification	Model	Remarks
Tightening Tool		---	A3C-3004	The tightening torque is 0.20 to 0.39 N·m.
Extractor		---	A3PJ-5080	---

Replacements

Name	Appearance	Classification	Model	Remarks
Legend Plate		For rectangular models	A3CJ-5201	One Legend Plate (milk-white) is supplied per standard Switch.
		For square models	A3CA-5201	
		For round models	A3CT-5201	

■ Specifications: Refer to page 8. ■ Dimensions: Refer to page 10.

Approved Standard Ratings

UL (File No. E41515), CSA (File No. LR45258)

Standard Load:	0.5 A at 250 VAC 1 A at 125 VAC 1 A at 30 VDC
Microload:	0.1 A at 125 VAC 0.1 A at 30 VDC

Note: Certification has been obtained for the Switch Unit.
For detailed information on individual products that have received certification, consult your supplier.

CCC (GB14048.5)

Standard Load:	0.5 A at 250 VAC
Microload:	0.1 A at 250 VAC

Ratings

Model	Item	AC resistive load	DC resistive load
Standard load		0.5 A at 250 VAC 1 A at 125 VAC	1 A at 30 VDC
Microload *		0.1 A at 125 VAC	0.1 A at 30 VDC

Note: The above ratings are for testing under the following conditions:

- 1) Load: Resistive load
- 2) Mounting conditions: No vibrations or shock
- 3) Temperature: 20°C ± 2°C
- 4) Operation frequency: 20 operations/minute

* The minimum permissible load is 1 mA, 5 VDC.

LED Lamp

Rated voltage	Rated current	Operating voltage	Internal limiting resistance
5 VDC	30 mA	5 VDC ± 5%	33 Ω
12 VDC	15 mA	12 VDC ± 5%	270 Ω
24 VDC	10 mA	24 VDC ± 5%	1,600 Ω

Incandescent Lamp

Rated voltage	Rated current	Operating voltage
6 VAC/DC	60 mA	5 VAC/DC
14 VAC/DC	40 mA	12 VAC/DC
28 VAC/DC	24 mA	24 VAC/DC

Characteristics

Operating frequency	Mechanical	Momentary-action models: 120 operations/minute max. Alternate-action models: 60 operations/minute max. *1
	Electrical	20 operations/minute max.
Contact Resistance	Standard load	50mΩ max.
	Microload	100mΩ max.
Insulation resistance		100 MΩ min. (at 500 VDC)
Dielectric strength	Between terminals of same polarity	1,000 VAC, 50/60 Hz for 1 min
	Between terminals of different polarity	2,000 VAC, 50/60 Hz for 1 min
	Between each terminal and ground	2,000 VAC, 50/60 Hz for 1 min
	Between lamp terminals	1,000 VAC, 50/60 Hz for 1 min *2
Vibration resistance	Malfunction	10 to 55 Hz, 1.5-mm double amplitude *3
Shock resistance	Destruction	500 m/s ²
	Malfunction	150 m/s ² *3
Durability	Mechanical	Momentary-operation models: 1,000,000 operations min. Alternate-operation models: 100,000 operations min. *1
	Electrical	100,000 operations min.
Weight		Approx. 5 g <The weight indicated here applies to the lighted models (SPST-NO+SPST-NC).>
Ambient operating temperature		-10°C to +55°C (with no icing or condensation)
Ambient operating humidity		35% to 85%RH
Ambient storage temperature		-25°C to +65°C (with no icing or condensation)
Degree of protection		IP40
Electric shock protection class		Class II
PTI (proof tracking index)		175
Pollution degree		3 (IEC60947-5-1)

*1. With alternate-operation models, one operation cycle consists of set and reset operations.

*2. The figure given above for the dielectric strength between lamp terminals is for when there is no LED lamp or incandescent lamp mounted.

*3. No malfunction for more than 1s.

Operating Characteristics

Operating force	OF max.	2.45 N {250 gf}
Releasing force	RF min.	0.29 N {30 gf}
Total travel	TT	Approx. 3.5 mm
Lock travel alternate	LTA min. *	0.5 mm
Pretravel	PT max.	2.5 mm

* Alternate operation models only.

Contact Form

Contact name	Contact form
SPDT	

Nomenclature
Model Structure
Display Unit Structure

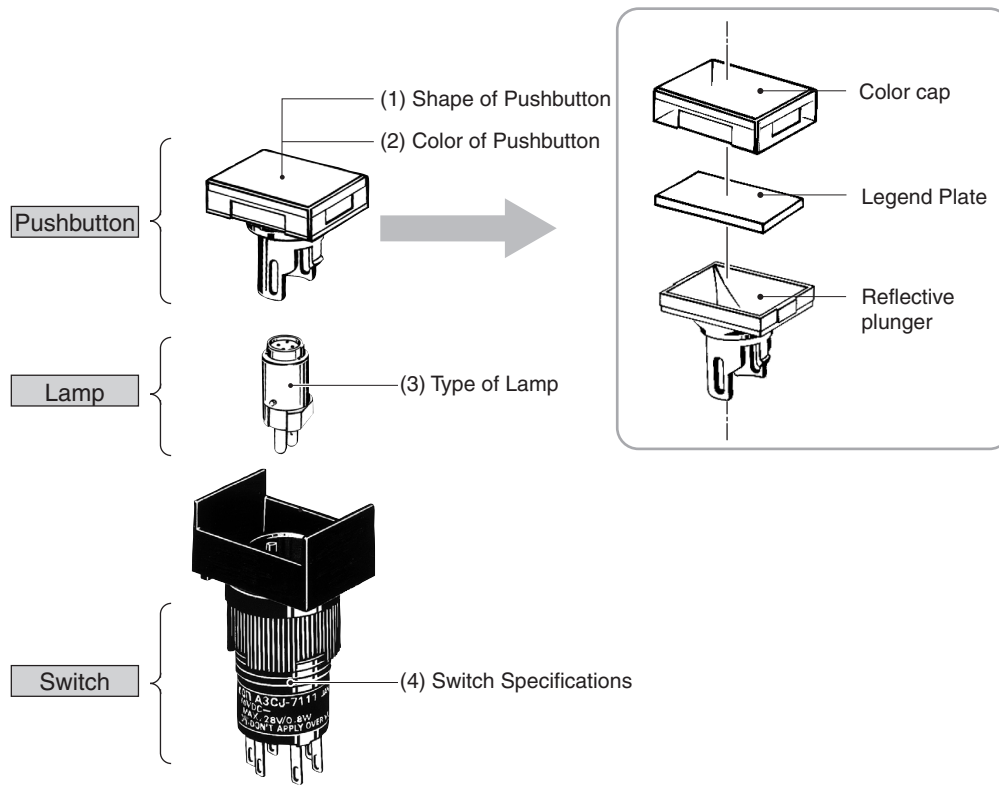

Note: The A3CJ model is shown here as a representative example.

	Type	Specifications
(1)	Shape of Pushbutton Rectangular (A3CJ) Square (A3CA) Round (A3CT) 	-----
(2)	LED lamp-lighted Models: Red, Yellow, Green, White Incandescent lamp-lighted Models: Red, Yellow, Green, White, Blue Non-lighted Models: Red, Yellow, Green, White, Blue, Black	-----
(3)	LED Lamp Incandescent Lamp 	
(4)	Standard load Microload	0.5 A at 250 VAC 1 A at 125 VAC 1 A at 30 VDC 0.1 A at 125 VAC 0.1 A at 30 VDC Minimum applicable load: 1 mA at 5 VDC

Dimensions

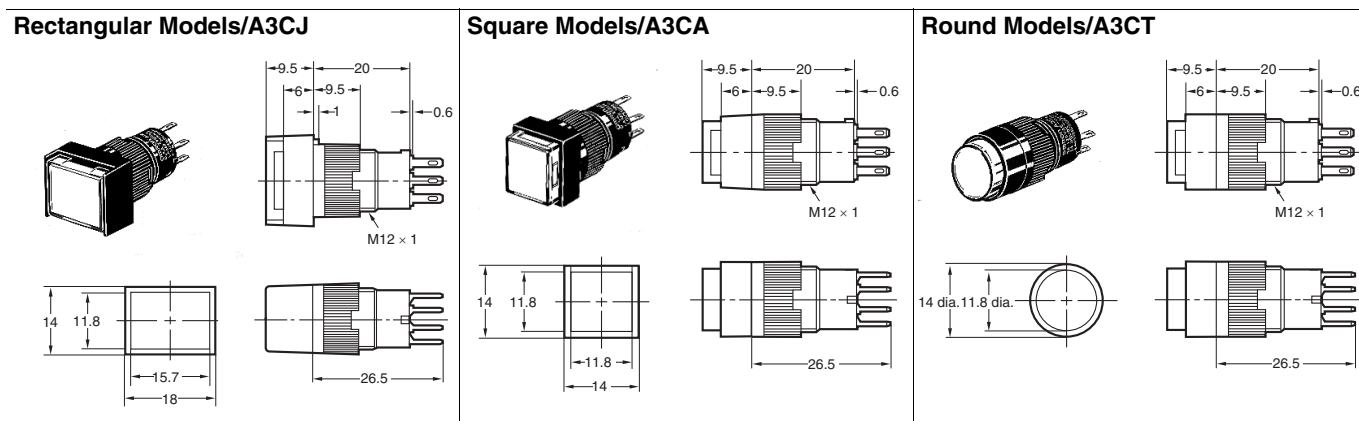

Terminal Connections

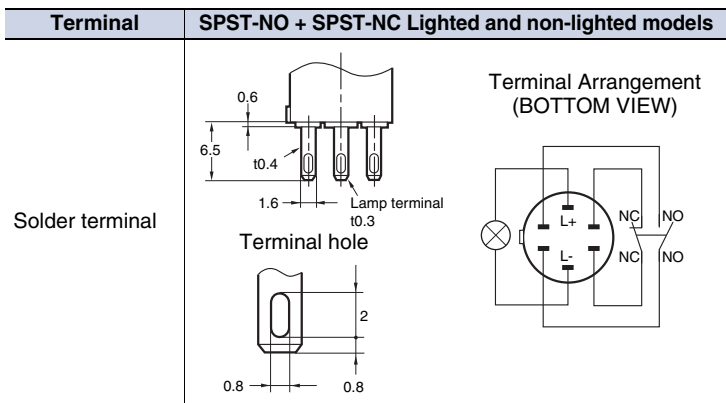

Panel Cutout (Top View)

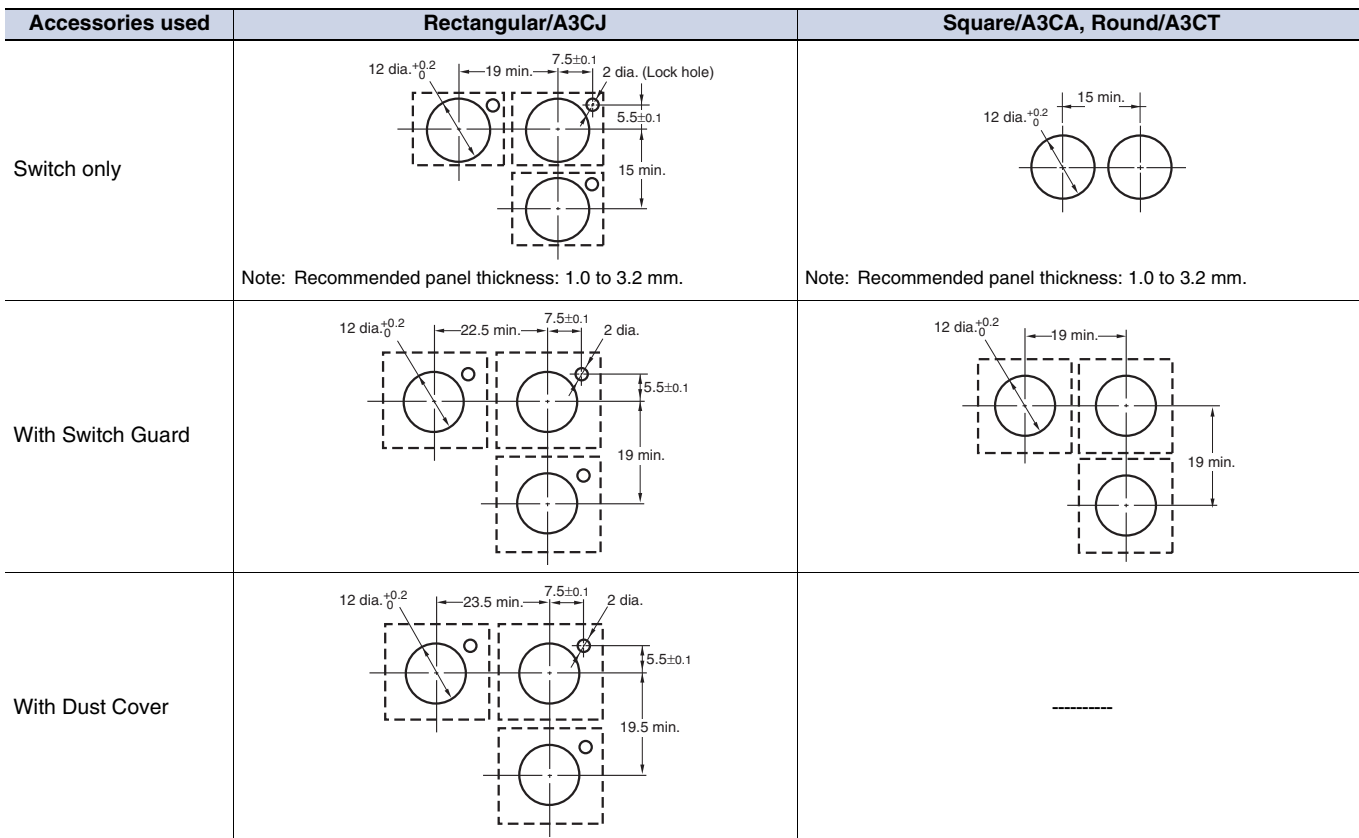

• If the panel is to be finished (e.g., coated), make sure that the panel meets the specified dimensions after the coating.

Dimensions

Accessory Mounting Dimensions

Dimensions with Socket Mounted (The diagrams below show the external dimensions for rectangular models as representative models.)

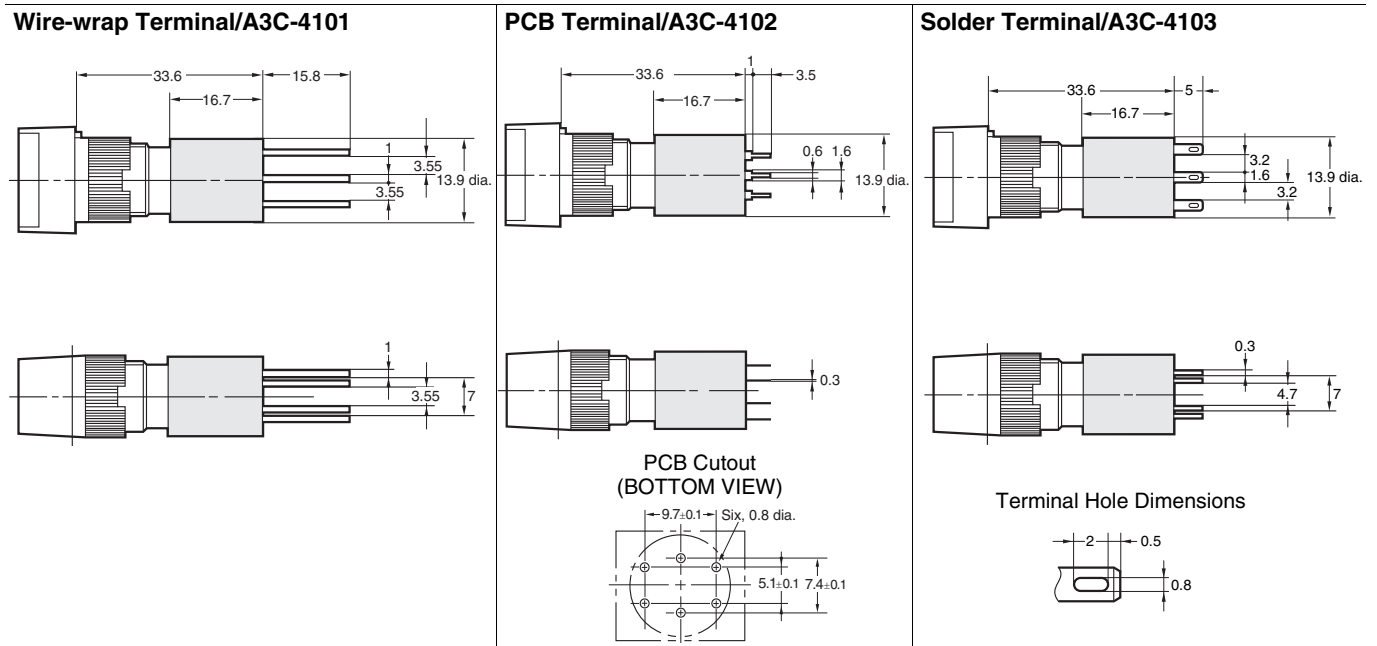

Switch Guard

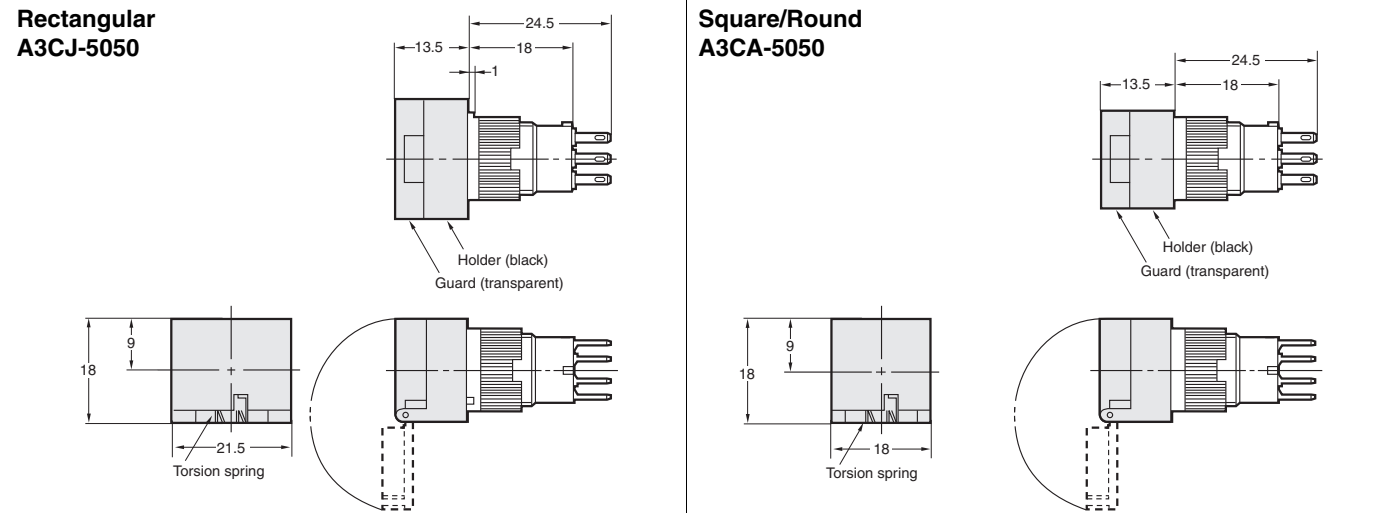

Dust Cover A3CJ-5060

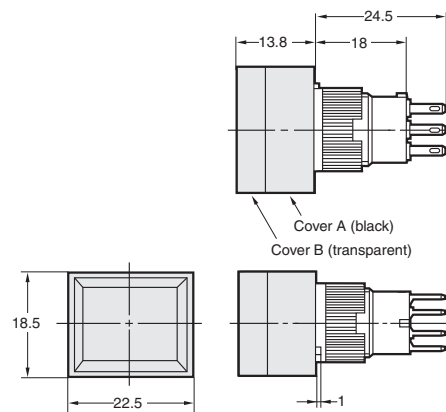

Legend Plate

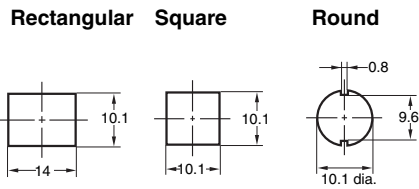

Note: 1. The thickness is 0.8 mm.
2. Since the Legend Plate is made of polycarbonate, use alcohol-based paints such as melanin, phthalic acid, or acrylic paint when marking the legend.

Insulation Cover A3C-3002

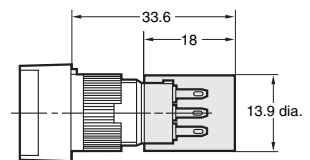

Safety Precautions

Refer to *Safety Precautions for All Pushbutton Switches*.

CAUTION

Do not apply a voltage higher than the maximum rated operating voltage between the lamp terminals, as there is a risk that the incandescent lamp or LED lamp will be damaged, and the Pushbutton will be ejected.



When replacing the incandescent lamp, first turn OFF the power supply, and then wait 10 minutes before performing replacement, as the lamp is still hot immediately after the power is turned OFF, so there is a risk of burns.



Precautions for Correct Use

Mounting

- To prevent electric shock or a fire, always make sure that the power is turned OFF before mounting, removing, or wiring the Switch, or performing maintenance.
- Do not tighten the mounting ring excessively using pliers or a similar tool. Excessive tightening may damage the mounting ring. (Tightening torque: 0.20 to 0.39 N·m {20 gf to 40 gf})

Wiring

- When wiring, use wires of a size appropriate for the applied voltage and carry current. Perform soldering correctly under the conditions given below. Using the Switch with the wires soldered incorrectly may cause the terminals to become abnormally hot and cause a fire.

1. Soldering iron tip temperature: 350°C max. within 3 seconds.
2. Dip soldering: At 350°C within 3 seconds.

Wait for one minute after soldering before exerting any external force on the solder.

- Use a non-corrosive rosin liquid for the flux.
- Perform wiring so that the wire sheaths do not come into contact with the Switch. If this is unavoidable, use wires that can withstand temperatures of 100°C min.
- After wiring to the Switch has been completed, ensure an appropriate insulation distance.

Operating Environment

- Do not use in locations that are subject to dust, oil, or metal filings as these may penetrate the interior of the Switch and cause malfunction.

Using Microloads

- Using a standard load switch for opening and closing a microload circuit may cause wear on the contacts. Use the switch within the operating range. (Refer to the diagram below.) Even when using microload models within the operating range shown below, if inrush current occurs when the contact is opened or closed, it may cause the contact surface to become rough, and so decrease life expectancy. Therefore, insert a contact protection circuit where necessary. The minimum applicable load is the N-level reference value. This value indicates the malfunction reference level for the reliability level of 60% ($\lambda 60$) (conforming to JIS C5003). The equation, $\lambda 60 = 0.5 \times 10^{-6}/\text{times}$ indicates that the estimated malfunction rate is less than 1/2,000,000 with a reliability level of 60%.

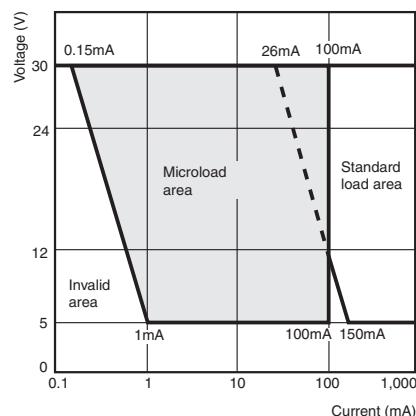

LED

- Resistance to limit the LED current is provided internally and so an external resistance is not required.

Rated voltage	Internal limiting resistance
5 VDC	33 Ω
12 VDC	270 Ω
24 VDC	1,600 Ω

Application

Mounting and Replacing the Pushbutton

(1) Mounting Direction for the Pushbutton/Display and Lamp Lighted Pushbutton Switch

- Insert the Lamp (incandescent lamp or LED lamp) into the Pushbutton so that the lamp guide fits into the wider gap between the projections on the Pushbutton.

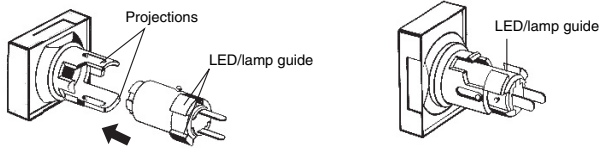

Indicator

- With Indicators, the Lamp is inserted facing the opposite direction (i.e., at 180°) to that for Lighted Pushbutton Switches.

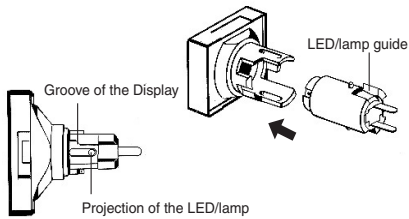

Note: Push the projections on the Lamp into the grooves on the Pushbutton/Display. The Lamp for Lighted Pushbutton Switches moves, but the Lamp for Indicators is fixed.

(2) Mounting Direction for the Pushbutton/Display and Switch

- Insert the Pushbutton/Display into the Switch so that the lamp guide is aligned with the non-projecting part of the Switch.
- Apply a pressure between 9.8 and 24.5 N.

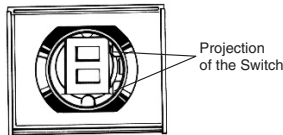

- Note: 1. The mounting direction for Indicators is 180° to that for Lighted Pushbutton Switches. Be sure to insert the Legend Plate and other parts with the correct orientation.
 2. If the terminals of the Lamp become bent, it may be impossible to fit them into the lamp terminal holes. Ensure that the terminals are straight when they are inserted.
 3. Take particular care about the mounting direction with the round models (A3CT).

(3) Removing the Pushbutton/Display

Hold the recessed portions on the cap of the Pushbutton and pull.

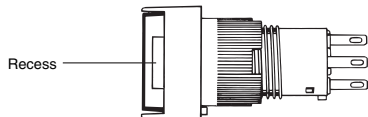

Note: Do not use tools such as pliers to remove the Pushbutton as this may damage the cap.

Panel Mounting

- Insert the Switch from the front of the panel. Mount the mounting nut from the terminal end of the Switch and tighten it.
- There are projections on the terminal end of the Switch which may, depending on the orientation, block the nut. In this case, turn the nut until it is possible to mount it. Tighten the nut to a torque between 0.20 and 0.39 N-m.
- If soldering is used, mount the mounting nut first. Lead wires and mounds of solder may make it impossible to mount the nut after soldering.

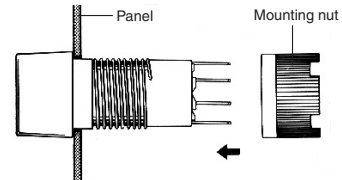

Socket Mounting

- After securing the Switch to the panel using the mounting nut, insert the Socket into the Switch.
- Align the positioning holes of the Socket with the projections of the Switch before inserting the Socket.

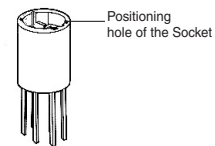
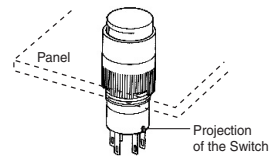

Mounting the Insulation Cover

- After securing the Switch to the panel using the mounting nut, pass the lead wires through the holes in the Insulation Cover and then perform wiring. Hold the Insulation Cover so that the cylindrical hole is facing the Switch, and insert the lead wires from the end with the barriers.
- After wiring is completed, mount the Insulation Cover by pushing it into the Switch.

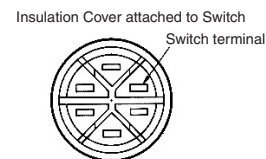

Mounting the Dust Cover

1. The Dust Cover separates into 2 parts: the cap and the mounting frame.
2. Insert the Switch into the mounting frame. (Align the lock projection with the recess on the mounting frame.)
3. Insert the Switch in the state described in step 2 into the panel. (Align the lock protrusion on the mounting frame with the hole in the panel.)
4. Mount the mounting nut from the back of the panel and tighten it.
5. Insert the cap into the mounting frame. Ensure that the entire perimeter of the cap is properly inserted into the mounting frame by pressing down on the cap from different directions.

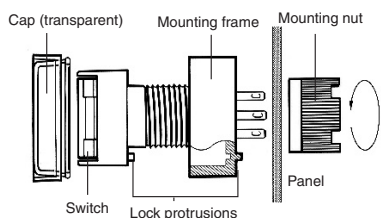

Mounting the Switch Guard

1. Insert the Switch into the Switch Guard.
2. Insert the Switch into the panel in the state described in step 1.
3. Mount the mounting nut from the back of the panel and tighten it.

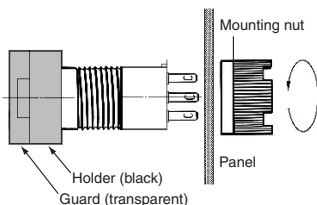

- Application examples provided in this document are for reference only. In actual applications, confirm equipment functions and safety before using the product.
- Consult your OMRON representative before using the product under conditions which are not described in the manual or applying the product to nuclear control systems, railroad systems, aviation systems, vehicles, combustion systems, medical equipment, amusement machines, safety equipment, and other systems or equipment that may have a serious influence on lives and property if used improperly. Make sure that the ratings and performance characteristics of the product provide a margin of safety for the system or equipment, and be sure to provide the system or equipment with double safety mechanisms.

Note: Do not use this document to operate the Unit.

OMRON Corporation

ELECTRONIC AND MECHANICAL COMPONENTS COMPANY

Contact: www.omron.com/ecb

Cat. No. A030-E1-05

0812(0207)(O)

Компания «Океан Электроники» предлагает заключение долгосрочных отношений при поставках импортных электронных компонентов на взаимовыгодных условиях!

Наши преимущества:

- Поставка оригинальных импортных электронных компонентов напрямую с производств Америки, Европы и Азии, а так же с крупнейших складов мира;
- Широкая линейка поставок активных и пассивных импортных электронных компонентов (более 30 млн. наименований);
- Поставка сложных, дефицитных, либо снятых с производства позиций;
- Оперативные сроки поставки под заказ (от 5 рабочих дней);
- Экспресс доставка в любую точку России;
- Помощь Конструкторского Отдела и консультации квалифицированных инженеров;
- Техническая поддержка проекта, помощь в подборе аналогов, поставка прототипов;
- Поставка электронных компонентов под контролем ВП;
- Система менеджмента качества сертифицирована по Международному стандарту ISO 9001;
- При необходимости вся продукция военного и аэрокосмического назначения проходит испытания и сертификацию в лаборатории (по согласованию с заказчиком);
- Поставка специализированных компонентов военного и аэрокосмического уровня качества (Xilinx, Altera, Analog Devices, Intersil, Interpoint, Microsemi, Actel, Aeroflex, Peregrine, VPT, Syfer, Eurofarad, Texas Instruments, MS Kennedy, Miteq, Cobham, E2V, MA-COM, Hittite, Mini-Circuits, General Dynamics и др.);

Компания «Океан Электроники» является официальным дистрибьютором и эксклюзивным представителем в России одного из крупнейших производителей разъемов военного и аэрокосмического назначения «JONHON», а так же официальным дистрибьютором и эксклюзивным представителем в России производителя высокотехнологичных и надежных решений для передачи СВЧ сигналов «FORSTAR».



JONHON

«JONHON» (основан в 1970 г.)

Разъемы специального, военного и аэрокосмического назначения:

(Применяются в военной, авиационной, аэрокосмической, морской, железнодорожной, горно- и нефтедобывающей отраслях промышленности)

«FORSTAR» (основан в 1998 г.)

ВЧ соединители, коаксиальные кабели, кабельные сборки и микроволновые компоненты:

(Применяются в телекоммуникациях гражданского и специального назначения, в средствах связи, РЛС, а так же военной, авиационной и аэрокосмической отраслях промышленности).



Телефон: 8 (812) 309-75-97 (многоканальный)

Факс: 8 (812) 320-03-32

Электронная почта: ocean@oceanchips.ru

Web: <http://oceanchips.ru/>

Адрес: 198099, г. Санкт-Петербург, ул. Калинина, д. 2, корп. 4, лит. А