

# D-Series

## HYDRAULIC-MAGNETIC CIRCUIT BREAKER

Designed for snap-on-back panel rail mounting on either a 35mm x 7.5mm, or a 35mm x 15mm Symmetrical Din Rail, allowing rapid and simple mounting and removal of the breaker. It features recessed, wire-ready, touch-proof, shock-resistant terminals, suitable for automatic screwdriver assembly, as well as “Dead Front” construction characteristics.

Available with a Visi-Rocker two-color actuator, which can be specified to indicate either the ON or the TRIPPED/OFF mode, or solid color rocker or handle type actuators. All actuator types fit in the same industry standard panel cutouts.



### Resources:

[Configure a Complete Part](#)

[Download CAD & Sales Drawing >](#)

### Product Highlights:

- 0.02 - 50 Amps
- 480 VAC or 65 VDC
- 1-4 poles (Handle)
- 1-3 poles (Rocker)
- Choice of Time Delays
- DIN rail mounting
- Precise temperature independent operation
- Wiping contacts – mechanical linkage with two-step
- Finger safe terminals
- Common trip linkage between poles ensures that an overload in one pole will trip all adjacent poles

### Typical Applications:

- Industrial Controls
- Renewable Energy



### Electrical

Maximum Voltage AC, 480 wye/277 VAC  
(See Table A), 50/60 Hz, 65VDC

Standard Current Coils 0.100, 0.250, 0.500, 0.750, 1.00, 2.50, 5.00, 7.50, 10.0, 15.0, 20.0, 25.0, 30.0, 35.0, 40.0 & 50.0.  
Other ratings available - consult factory.

Standard Voltage Coils DC - 6V, 12V; AC - 120V, other ratings available, see ordering scheme.

Insulation Resistance Minimum of 100 Megohms at 500 VDC.

Dielectric Strength UL, CSA: 1960 V 50/60 Hz for one minute between all electrically isolated terminals. D-Series circuit breakers comply with the 8mm spacing and 3750V 50/60 Hz dielectric requirements from hazardous voltage to operator accessible surfaces and between adjacent poles per Publications EN 60950 and VDE 0805.

Resistance, Impedance Values from Line to Load Terminal - based on Series Trip Circuit Breaker

### Mechanical

Endurance 10,000 ON-OFF operations @ 6 per minute; with rated Current and Voltage.

Trip Free All D-Series Circuit Breakers will trip on overload, even when actuator is forcibly held in the ON position.

Trip Indication The operating actuator moves positively to the OFF position when an overload causes the breaker to trip.

### Physical

Number of Poles Rocker Type: 1-3; Handle Type: 1-4

Internal Circuit Config. Switch Only and Series Trip with current or voltage trip coils.

Weight Approximately 128 grams/pole (Approximately 4.57 ounces/pole)

Standard Colors Housing - Black; Actuator - See Ordering Scheme.

Mounting Mounts on a standard 35mm Symmetrical DIN Rail (35 x 7.5 or 35 x 15mm per DIN EN5002).

### Environmental

Designed and tested in accordance with requirements of specification MIL-PRF-55629 & MIL-STD-202 as follows:

Shock Withstands 100 Gs, 6ms, sawtooth while carrying rated current per Method 213, Test Condition "I". Instantaneous and ultra-short curves tested @ 90% of rated current.

Vibration Withstands 0.060" excursion from 10-55 Hz, and 10 Gs 55-500 Hz, at rated current per Method 204C, Test Condition A. Instantaneous and ultra-short curves tested at 90% of rated current.

Moisture Resistance Method 106D, i.e., ten 24-hour cycles @ + 25°C to +65°C, 80-98% RH.

Salt Spray Method 101, Condition A (90-95% RH @ 5% NaCl Solution, 96 hrs).

Thermal Shock Method 107D, Condition A (Five cycles @ -55°C to +25°C to +85°C to +25°C).

Operating Temperature -40° C to +85° C

RESISTANCE PER POLE VALUES from Line to Load Terminals (Values Based on Series Trip Circuit Breaker)

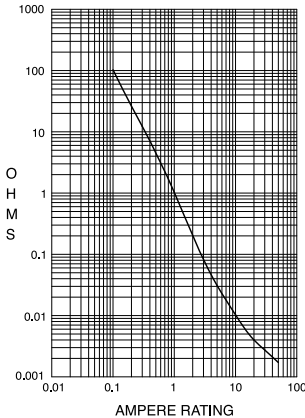

CURRENT (AMPS)	TOLERANCE (%)
0.10 - 5.0	15
5.1 - 20.0	25
20.1 - 50.0	35

Pulse Tolerance Curves

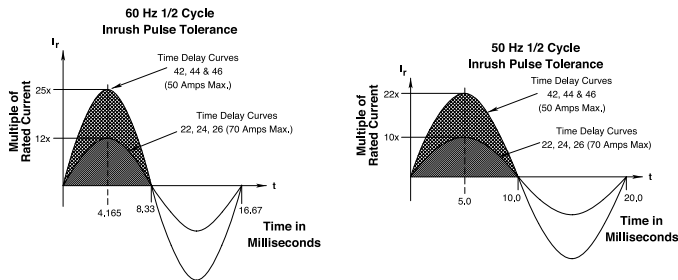

\*Manufacturer reserves the right to change product specification without prior notice.

## Electrical Tables

Table A: Lists UL Recognized, CSA Accepted and VDE Certified configurations and performance capabilities as a Component Supplementary Protector.

D-SERIES TABLE A: COMPONENT SUPPLEMENTARY PROTECTORS										
CIRCUIT CONFIGURATION	VOLTAGE			CURRENT RATING	SHORT CIRCUIT CAPACITY (AMPS)				APPLICATION CODES	
	MAX. RATING	FREQUENCY	PHASE <sup>1</sup>		UL/CSA		VDE		UL	CSA
				FULL LOAD AMPS	WITH BACKUP FUSE	WITH BACKUP FUSE	(Inc) WITH BACKUP FUSE	(Inc) WITHOUT BACKUP FUSE		
SERIES	65	DC	---	0.02 - 50	---	5,000	5,000	1,500	TC1,2, OL1, U1	TC1,2, OL1, U1
	80	DC	---	0.02 - 50	---	5,000	5,000	1,500	TC1,2, OL1, U1	TC1,2, OL1, U1
	125 / 250	50 / 60	1	0.02 - 50	---	3,000	---	---	TC1,2, OL1, U1	TC1,2, OL1, U1
	250	50 / 60	1 & 3	0.02 - 50	5,000 <sup>2</sup>	---	5,000	1,500	TC1,2, OL1, C1	TC1,2, OL1, C1
	277	50 / 60	1	0.02 - 50	5,000 <sup>2</sup>	---	---	---	TC1,2, OL1, C1	TC1,2, OL1, C1
	480 Y <sup>3</sup>	50 / 60	1 & 3	0.02 - 50	5,000 <sup>2</sup>	---	---	---	TC1,2, OL1, C1	TC1,2, OL1, C1
SWITCH ONLY	65	DC	---	0.02 - 50						
	250	50 / 60	3	0.02 - 50						
	277	50 / 60	1	0.02 - 50						
	480 Y <sup>3</sup>	50 / 60	1 & 3	0.02 - 30						

Notes:

- 1 DC and 1 Phase 277 V ratings are 1 or 2 poles breaking. Three phase ratings are 3 poles breaking.
- 2 Requires branch circuit backup with a UL LISTED Type K5 or RK5 fuse rated 15A minimum and no more than 4 times full load amps not to exceed 150 A for 250V rating and 125 A for 277 and 480 V ratings.
- 3 UL recognition and CSA Acceptance at 480 volts refers to 3 and 4 pole versions, used only in a 3 phase WYE connected circuit or 2 pole versions connected with 2 poles breaking 1 phase and backed up with series fusing per note 2

## Agency Certifications

### UL Recognized

UL Standard 1077



Component Recognition Program as Protectors, Supplementary (Guide QVNU2, File E75596)

### CSA Accepted



Component Supplementary Protector under Class 3215 30, File 047848 0 000  
CSA Standard C22.2 No. 235

### UL Listed

UL Standard 508



Switches, Industrial Control (Guide NRNT2, File E148683)

### VDE Certified



EN60934, VDE 0642 under File No. 10537



**1 SERIES**

**D**

**2 ACTUATOR<sup>1</sup>**

**Handle<sup>2</sup>**

- A** Handle, one per pole
- B** Handle, one per multipole unit

**Visi-Rocker<sup>3</sup>**

- C** Indicate ON, vertical legend
- D** Indicate ON, horizontal legend
- E** Indicate ON, no legend (VDE approval not available with no legend)
- F** Indicate OFF, vertical legend
- G** Indicate OFF, horizontal legend
- H** Indicate OFF, no legend (VDE approval not available with no legend)

**Single Color Rocker<sup>3</sup>**

- J** Vertical legend
- K** Horizontal legend
- L** No legend (VDE approval not available with no legend)

**ROCKER STYLE DESCRIPTIONS**

	INDICATE "ON"	INDICATE "OFF"	SINGLE COLOR
<b>VERTICAL STYLE</b>	<p>INDICATE COLOR LOCATION</p>		
<b>HORIZONTAL STYLE</b>			

**3 POLES**

- 1 One
- 2 Two
- 3 Three
- 4 Four

**4 CIRCUIT**

- A0** Switch Only (No Coil)<sup>4</sup>
- B0** Series Trip (Current)
- C0** Series Trip (Voltage)

**5 FREQUENCY & DELAY**

- 03** DC 50/60Hz, Switch Only
- 10<sup>5</sup>** DC Instantaneous
- 11** DC Ultra Short
- 12** DC Short
- 14** DC Medium
- 16** DC Long
- 20<sup>5</sup>** 50/60Hz Instantaneous
- 21** 50/60Hz Ultra Short
- 22** 50/60Hz Short
- 24** 50/60Hz Medium
- 26** 50/60Hz Long
- 32** DC, 50/60Hz Short
- 34** DC, 50/60Hz Medium
- 36** DC, 50/60Hz Long
- 42<sup>6</sup>** 50/60Hz Short, High-inrush
- 44<sup>6</sup>** 50/60Hz Medium, High-inrush
- 46<sup>6</sup>** 50/60Hz Long, High-inrush
- 52<sup>6</sup>** DC, Short, High-inrush
- 54<sup>6</sup>** DC, Medium, High-inrush
- 56<sup>6</sup>** DC, Long, High-inrush

**Notes:**

- 1 Handle breakers available up to four poles. Rocker breakers available up to three poles.
- 2 Actuator Code:
  - A: Multi-pole units factory assembled with common handle tie.
  - B: Handle location as viewed from front of breaker:
    - 2 pole - left pole
    - 3 pole - center pole
    - 4 pole - two handles at center poles
- 3 Multipole rocker breakers have one rocker per breaker, as viewed from the front of the panel. Two pole - left pole. Three pole - center pole
- 4  $\leq 30A$ , select Current Rating code 630. 31-50A, select Current Rating code 650.
- 5 Voltage coil only available with delay codes 10 & 20.
- 6 Available to 50A max with circuit code B0 only.
- 7 Color shown is visi and legend with remainder of rocker black.
- 8  $\geq 300V$ : Three pole breaker 3Ø or 2 pole breaker 1Ø, UL/CSA limited to 30 FLA max.
- 9 VDE Approval requires Dual (I-O, ON-OFF) or I-O markings

**7 CURRENT RATING (AMPERES)<sup>9</sup>**

CODE	AMPERES	CODE	AMPERES	CODE	AMPERES	CODE	AMPERES
020	0.020	275	0.750	450	5.000	616	16.000
025	0.025	280	0.800	455	5.500	617	17.000
030	0.030	285	0.850	460	6.000	618	18.000
050	0.050	410	1.000	465	6.500	619	19.000
075	0.075	512	1.250	470	7.000	620	20.000
080	0.080	413	1.300	572	7.250	621	21.000
085	0.085	414	1.400	475	7.500	622	22.000
210	0.100	415	1.500	480	8.000	623	23.000
215	0.150	517	1.750	485	8.500	624	24.000
220	0.200	420	2.000	490	9.000	625	25.000
225	0.250	522	2.250	495	9.500	626	26.000
230	0.300	425	2.500	610	10.000	627	27.000
235	0.350	527	2.750	710	10.500	628	28.000
240	0.400	430	3.000	611	11.000	629	29.000
245	0.450	532	3.250	711	11.500	630	30.000
250	0.500	435	3.500	612	12.000	632	32.000
255	0.550	436	3.600	712	12.500	635	35.000
260	0.600	440	4.000	613	13.000	640	40.000
265	0.650	445	4.500	614	14.000	645	45.000
270	0.700	547	4.750	615	15.000	650	50.000

**OR VOLTAGE COIL (NORMAL RATED VOLTAGE)<sup>7</sup>**

CODE	AMPERES	CODE	AMPERES	CODE	AMPERES
A06	6 DC, 5 DC	A48	48 DC, 40 DC	J24	24 AC, 20 AC
A12	12 DC, 10 DC	A65	65 DC, 55 DC	J48	48 AC, 40 AC
A18	18 DC, 15 DC	J06	6 AC, 5 AC	K20	120 AC, 65 AC
A24	24 DC, 20 DC	J12	12 AC, 10 AC	L40	240 AC, 130 AC
A32	32 DC, 25 DC	J18	18 AC, 15 AC		

**7 TERMINAL**

- 1 #10 Screw & Pressure Plate for Direct Wire Connection
- 2 #10 Screw without Pressure Plate

**8 ACTUATOR COLOR & LEGEND**

Actuator or Visi-Color	Marking:	Marking Color:	Single Color Rocker/Handle	Visi-Rocker (Actuator Black) <sup>7</sup>
Color	I-O ON-OFF Dual			
White	A B 1	Black	Black/Handle	White
Black	C D 2	White		N/A
Red	F G 3	White		Red
Green	H J 4	White		Green
Blue	K L 5	White		Blue
Yellow	M N 6	Black		Yellow
Gray	P Q 7	Black		Gray
Orange	R S 8	Black		Orange

**9 MOUNTING / VOLTAGE**

	MOUNTING STYLE	VOLTAGE
	<b>Threaded Insert</b>	
1	6-32 x 0.195 inches	< 300
C <sup>8</sup>	6-32 X 0.195 inches	$\geq 300$
2	ISO M3 x 5mm	< 300
D <sup>8</sup>	ISO M3 x 5mm	$\geq 300$

**10 AGENCY APPROVAL**

- C** UL Recognized & CSA Accepted
- D<sup>9</sup>** VDE Certified, UL Recognized & CSA Accepted

## Circuit & Terminal Diagrams: in. [mm]



(HANDLE ACTUATOR SHOWN)

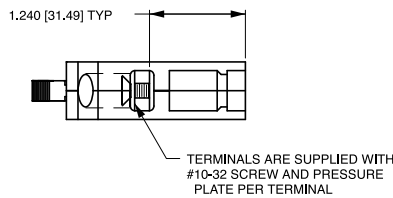
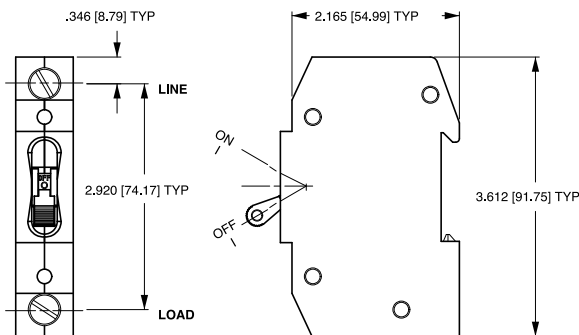
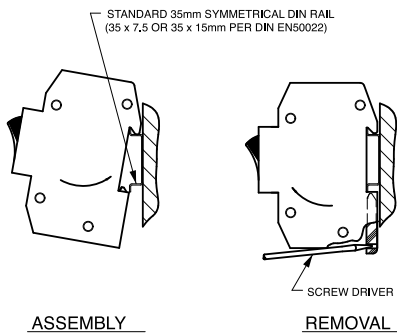
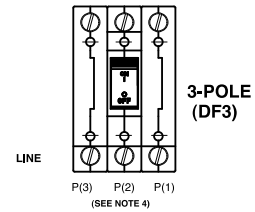
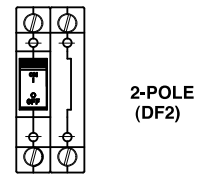
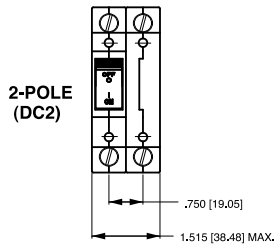

TABLE A TIGHTENING TORQUE SPECIFICATIONS	
THREAD SIZE	TORQUE
#6-32 [M3] HARDWARE	7-9 IN-LBS [0.8-1.0 NM]
#10-32 THD TERMINAL SCREW	15-20 IN-LBS [1.7-2.3 NM]

- Notes:  
 1 All dimensions are in inches [millimeters].  
 2 Tolerance  $\pm .020$  [.51] unless otherwise specified.

## Dimensional Specifications: in. [mm]



- Notes:
- 1 All dimensions are in inches [millimeters].
  - 2 Tolerance  $\pm 0.020$  [.51] unless otherwise specified.
  - 3 Dimensions apply to all variations shown. Notice that circuit breaker line and load terminal orientation on indicate OFF is opposite of indicate ON.
  - 4 For pole orientation with horizontal legend, rotate front view clockwise 90°.

## Dimensional Specifications: in. [mm]



Notes:  
 1 All dimensions are in inches [millimeters].  
 2 Tolerance  $\pm 0.10$  [2.5] unless otherwise specified.

## Authorized Sales Representatives and Distributors

Click on a region of the map below to find your local representatives and distributors or visit [www.carlingtech.com/findarep](http://www.carlingtech.com/findarep).



## About Carling

Founded in 1920, Carling Technologies is a leading manufacturer of electrical and electronic switches and assemblies, circuit breakers, electronic controls, power distribution units, and multiplexed power distribution systems. With four ISO9001 and IATF16949 registered manufacturing facilities and technical sales offices worldwide, Carling Technologies Sales, Service and Engineering teams do much more than manufacture electrical components, they engineer powerful solutions! To learn more about Carling please visit [www.carlingtech.com/company-profile](http://www.carlingtech.com/company-profile).

To view all of Carling's environmental, quality, health & safety certifications please visit [www.carlingtech.com/environmental-certifications](http://www.carlingtech.com/environmental-certifications)



## **Worldwide Headquarters**

Carling Technologies, Inc.  
60 Johnson Avenue, Plainville, CT 06062  
**Phone:** 860.793.9281 **Fax:** 860.793.9231  
**Email:** sales@carlingtech.com

**Northern Region Sales Office:** nrsm@carlingtech.com  
**Southeast Region Sales Office:** sersm@carlingtech.com  
**Midwest Region Sales Office:** mrrsm@carlingtech.com  
**West Region Sales Office:** wrsm@carlingtech.com  
**Latin America Sales Office:** larsm@carlingtech.com

## **Asia-Pacific Headquarters**

Carling Technologies, Asia-Pacific Ltd.,  
Suite 1607, 16/F Tower 2, The Gateway,  
Harbour City, 25 Canton Road,  
Tsimshatsui, Kowloon, Hong Kong  
**Phone:** Int + 852-2737-2277 **Fax:** Int + 852-2736-9332  
**Email:** sales@carlingtech.com.hk

**Shenzhen, China:** shenzhen@carlingtech.com  
**Shanghai, China:** shanghai@carlingtech.com  
**Pune, India:** india@carlingtech.com  
**Kaohsiung, Taiwan:** taiwan@carlingtech.com  
**Yokohama, Japan:** japan@carlingtech.com

## **Europe | Middle East | Africa Headquarters**

Carling Technologies LTD  
4 Airport Business Park, Exeter Airport,  
Clyst Honiton, Exeter, Devon, EX5 2UL, UK  
**Phone:** Int + 44 1392.364422 **Fax:** Int + 44 1392.364477  
**Email:** ltd.sales@carlingtech.com

**Germany:** gmbh@carlingtech.com  
**France:** sas@carlingtech.com



**Carling Technologies®**

Innovative Designs. Powerful Solutions.

Компания «Океан Электроники» предлагает заключение долгосрочных отношений при поставках импортных электронных компонентов на взаимовыгодных условиях!

Наши преимущества:

- Поставка оригинальных импортных электронных компонентов напрямую с производств Америки, Европы и Азии, а так же с крупнейших складов мира;
- Широкая линейка поставок активных и пассивных импортных электронных компонентов (более 30 млн. наименований);
- Поставка сложных, дефицитных, либо снятых с производства позиций;
- Оперативные сроки поставки под заказ (от 5 рабочих дней);
- Экспресс доставка в любую точку России;
- Помощь Конструкторского Отдела и консультации квалифицированных инженеров;
- Техническая поддержка проекта, помощь в подборе аналогов, поставка прототипов;
- Поставка электронных компонентов под контролем ВП;
- Система менеджмента качества сертифицирована по Международному стандарту ISO 9001;
- При необходимости вся продукция военного и аэрокосмического назначения проходит испытания и сертификацию в лаборатории (по согласованию с заказчиком);
- Поставка специализированных компонентов военного и аэрокосмического уровня качества (Xilinx, Altera, Analog Devices, Intersil, Interpoint, Microsemi, Actel, Aeroflex, Peregrine, VPT, Syfer, Eurofarad, Texas Instruments, MS Kennedy, Miteq, Cobham, E2V, MA-COM, Hittite, Mini-Circuits, General Dynamics и др.);

Компания «Океан Электроники» является официальным дистрибьютором и эксклюзивным представителем в России одного из крупнейших производителей разъемов военного и аэрокосмического назначения «**JONHON**», а так же официальным дистрибьютором и эксклюзивным представителем в России производителя высокотехнологичных и надежных решений для передачи СВЧ сигналов «**FORSTAR**».



## JONHON

«**JONHON**» (основан в 1970 г.)

Разъемы специального, военного и аэрокосмического назначения:

(Применяются в военной, авиационной, аэрокосмической, морской, железнодорожной, горно- и нефтедобывающей отраслях промышленности)

«**FORSTAR**» (основан в 1998 г.)

ВЧ соединители, коаксиальные кабели,  
кабельные сборки и микроволновые компоненты:

(Применяются в телекоммуникациях гражданского и специального назначения, в средствах связи, РЛС, а так же военной, авиационной и аэрокосмической отраслях промышленности).



Телефон: 8 (812) 309-75-97 (многоканальный)

Факс: 8 (812) 320-03-32

Электронная почта: [ocean@oceanchips.ru](mailto:ocean@oceanchips.ru)

Web: <http://oceanchips.ru/>

Адрес: 198099, г. Санкт-Петербург, ул. Калинина, д. 2, корп. 4, лит. А