

### FEATURES

- Complete supervisory and sequencing solution for up to 10 supplies**
- 10 supply fault detectors enable supervision of supplies to <0.5% accuracy at all voltages at 25°C**
- <1.0% accuracy across all voltages and temperatures**
- 5 selectable input attenuators allow supervision of supplies to 14.4 V on VH**
- 6 V on VP1 to VP4 (VPx)**
- 5 dual-function inputs, VX1 to VX5 (VXx)**
  - High impedance input to supply fault detector with thresholds between 0.573 V and 1.375 V**
  - General-purpose logic input**
- 10 programmable driver outputs, PDO1 to PDO10 (PDOx)**
  - Open-collector with external pull-up**
  - Push/pull output, driven to VDDCAP or VPx**
  - Open collector with weak pull-up to VDDCAP or VPx**
  - Internally charge-pumped high drive for use with external N-FET (PDO1 to PDO6 only)**
- Sequencing engine (SE) implements state machine control of PDO outputs**
  - State changes conditional on input events**
  - Enables complex control of boards**
  - Power-up and power-down sequence control**
  - Fault event handling**
  - Interrupt generation on warnings**
  - Watchdog function can be integrated in SE**
  - Program software control of sequencing through SMBus**
- Complete voltage margining solution for 6 voltage rails**
- 6 voltage output, 8-bit DACs (0.300 V to 1.551 V) allow voltage adjustment via dc-to-dc converter trim/feedback node**
- 12-bit ADC for readback of all supervised voltages**
- Internal and external temperature sensors**
- Reference input (REFIN) has 2 input options**
- Driven directly from 2.048 V ( $\pm 0.25\%$ ) REFOUT pin**
- More accurate external reference for improved ADC performance**
- Device powered by the highest of VPx, VH for improved redundancy**
- User EEPROM: 256 bytes**
- Industry-standard 2-wire bus interface (SMBus)**
- Guaranteed PDO low with VH, VPx = 1.2 V**
- Available in 40-lead, 6 mm × 6 mm LFCSP and 48-lead, 7 mm × 7 mm TQFP packages**

### FUNCTIONAL BLOCK DIAGRAM

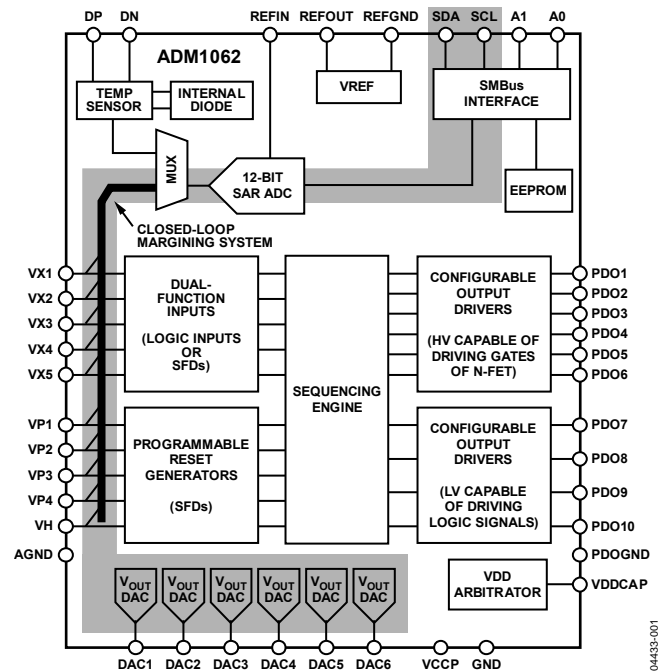

Figure 1.

### APPLICATIONS

- Central office systems
- Servers/routers
- Multivoltage system line cards
- DSP/FPGA supply sequencing
- In-circuit testing of margined supplies

### GENERAL DESCRIPTION

The [ADM1062](#) Super Sequencer® is a configurable supervisory/sequencing device that offers a single-chip solution for supply monitoring and sequencing in multiple-supply systems. In addition to these functions, the [ADM1062](#) integrates a 12-bit ADC and six 8-bit voltage output DACs. These circuits can be used to implement a closed-loop margining system that enables supply adjustment by altering either the feedback node or the reference of a dc-to-dc converter using the DAC outputs.

For more information about the [ADM1062](#) register map, refer to the [AN-698 Application Note](#).

## TABLE OF CONTENTS

Features .....	1	Sequencing Engine Application Example .....	20
Functional Block Diagram .....	1	Fault and Status Reporting .....	21
Applications .....	1	Voltage Readback .....	22
General Description .....	1	Supply Supervision with the ADC .....	22
Revision History .....	3	Supply Margining .....	23
Detailed Block Diagram .....	4	Overview .....	23
Specifications .....	5	Open-Loop Supply Margining .....	23
Absolute Maximum Ratings .....	8	Closed-Loop Supply Margining .....	23
Thermal Resistance .....	8	Writing to the DACs .....	24
ESD Caution .....	8	Choosing the Size of the Attenuation Resistor .....	24
Pin Configurations and Function Descriptions .....	9	DAC Limiting and Other Safety Features .....	24
Typical Performance Characteristics .....	11	Temperature Measurement System .....	25
Powering the ADM1062 .....	14	Remote Temperature Measurement .....	25
Slew Rate Consideration .....	14	Applications Diagram .....	27
Inputs .....	15	Communicating with the ADM1062 .....	28
Supply Supervision .....	15	Configuration Download at Power-Up .....	28
Programming the Supply Fault Detectors .....	15	Updating the Configuration .....	28
Input Comparator Hysteresis .....	15	Updating the Sequencing Engine .....	29
Input Glitch Filtering .....	16	Internal Registers .....	29
Supply Supervision with VXx Inputs .....	16	EEPROM .....	29
VXx Pins as Digital Inputs .....	17	Serial Bus Interface .....	29
Outputs .....	18	SMBus Protocols for RAM and EEPROM .....	32
Supply Sequencing Through Configurable Output Drivers .....	18	Write Operations .....	32
Default Output Configuration .....	18	Read Operations .....	34
Sequencing Engine .....	19	Outline Dimensions .....	35
Overview .....	19	Ordering Guide .....	35
Warnings .....	19		
SMBus Jump (Unconditional Jump) .....	19		

**REVISION HISTORY****1/15—Rev. C to Rev. D**

Changed Round-Robin Circuit to ADC Round-Robin .....	Throughout
Changes to Figure 4 and Table 4 .....	9
Added Slew Rate Consideration Section.....	14
Added VP1 Glitch Filtering Section .....	16
Added SCL Held Low Timeout Section and False Start Detection Section .....	30
Updated Outline Dimensions.....	35
Changes to Ordering Guide.....	35

**6/11—Rev. B to Rev. C**

Changes to Serial Bus Timing Parameter in Table 1 .....	5
Change to Figure 3 .....	9
Added Exposed Pad Notation to Outline Dimensions .....	34
Changes to Ordering Guide.....	35

**5/08—Rev. A to Rev. B**

Changes to Table 1 .....	4
Changes to Powering the ADM1062 Section .....	13
Changes to Table 5 .....	14
Changes to Sequence Detector Section .....	18
Changes to Temperature Measurement System Section .....	23

Changes to Table 11 .....	24
Changes to Configuration Download at Power-Up Section .....	26
Changes to Table 12 .....	27
Changes to Figure 49 and Error Correction Section.....	32
Changes to Ordering Guide.....	34

**12/06—Rev. 0 to Rev. A**

Updated Format .....	Universal
Changes to Features .....	1
Changes to Figure 2 .....	3
Changes to Table 1 .....	4
Changes to Table 2 .....	7
Changes to Absolute Maximum Ratings Section .....	9
Changes to Programming the Supply Fault Detectors Section ...	14
Changes to Table 6 .....	14
Changes to Outputs Section .....	16
Changes to Fault Reporting Section .....	20
Changes to Table 9 .....	21
Changes to Identifying the ADM1062 on the SMBus Section.....	28
Changes to Figure 39 and Figure 30 .....	30

**4/05—Revision 0: Initial Version**

Supply margining can be performed with a minimum of external components. The margining loop can be used for in-circuit testing of a board during production (for example, to verify board functionality at -5% of nominal supplies), or it can be used dynamically to accurately control the output voltage of a dc-to-dc converter.

The device also provides up to 10 programmable inputs for monitoring undervoltage faults, overvoltage faults, or out-of-window faults on up to 10 supplies. In addition, 10 programmable outputs can be used as logic enables. Six of these programmable outputs can also provide up to a 12 V output for driving the gate of an N-FET that can be placed in the path of a supply.

Temperature measurement is possible with the ADM1062. The device contains one internal temperature sensor and a differential input for a remote thermal diode. Both are measured by the 12-bit ADC.

The logical core of the device is a sequencing engine. This state-machine-based construction provides up to 63 different states. This design enables very flexible sequencing of the outputs, based on the condition of the inputs.

The ADM1062 is controlled via configuration data that can be programmed into an EEPROM. The entire configuration can be programmed using an intuitive GUI-based software package provided by Analog Devices, Inc.

DETAILED BLOCK DIAGRAM



Figure 2.

## SPECIFICATIONS

V<sub>H</sub> = 3.0 V to 14.4 V<sup>1</sup>, V<sub>Px</sub> = 3.0 V to 6.0 V<sup>1</sup>, T<sub>A</sub> = -40°C to +85°C, unless otherwise noted.

Table 1.

Parameter	Min	Typ	Max	Unit	Test Conditions/Comments
<b>POWER SUPPLY ARBITRATION</b>					
V <sub>H</sub> , V <sub>Px</sub>	3.0			V	Minimum supply required on one of the V <sub>H</sub> , V <sub>Px</sub> pins
V <sub>Px</sub>			6.0	V	Maximum VDDCAP = 5.1 V, typical
V <sub>H</sub>			14.4	V	VDDCAP = 4.75 V
VDDCAP	2.7	4.75	5.4	V	Regulated LDO output
C <sub>VDDCAP</sub>	10			μF	Minimum recommended decoupling capacitance
<b>POWER SUPPLY</b>					
Supply Current, I <sub>VH</sub> , I <sub>VPx</sub>		4.2	6	mA	VDDCAP = 4.75 V, PDO1 to PDO10 off, DACs off, ADC off
Additional Currents					
All PDO FET Drivers On		1		mA	VDDCAP = 4.75 V, PDO1 to PDO6 loaded with 1 μA each, PDO7 to PDO10 off
Current Available from VDDCAP			2	mA	Maximum additional load that can be drawn from all PDO pull-ups to VDDCAP
DAC Supply Currents		2.2		mA	Six DACs on with 100 μA maximum load on each
ADC Supply Current		1		mA	Running round-robin loop
EEPROM Erase Current		10		mA	1 ms duration only, VDDCAP = 3 V
<b>SUPPLY FAULT DETECTORS</b>					
<b>V<sub>H</sub> Pin</b>					
Input Impedance		52		kΩ	Midrange and high range
Input Attenuator Error		±0.05		%	
<b>Detection Ranges</b>					
High Range	6		14.4	V	
Midrange	2.5		6	V	
<b>V<sub>Px</sub> Pins</b>					
Input Impedance		52		kΩ	Low range and midrange
Input Attenuator Error		±0.05		%	
<b>Detection Ranges</b>					
Midrange	2.5		6	V	
Low Range	1.25		3	V	
Ultralow Range	0.573		1.375	V	No input attenuation error
<b>V<sub>Xx</sub> Pins</b>					
Input Impedance	1			MΩ	No input attenuation error
<b>Detection Range</b>					
Ultralow Range	0.573		1.375	V	
Absolute Accuracy			±1	%	
Threshold Resolution		8		Bits	Minimum programmable filter length
Digital Glitch Filter		0		μs	
		100		μs	Maximum programmable filter length
<b>ANALOG-TO-DIGITAL CONVERTER</b>					
Signal Range	0		V <sub>REFIN</sub>	V	The ADC can convert signals presented to the V <sub>H</sub> , V <sub>Px</sub> , and V <sub>Xx</sub> pins; V <sub>Px</sub> and V <sub>H</sub> input signals are attenuated depending on the selected range; a signal at the pin corresponding to the selected range is from 0.573 V to 1.375 V at the ADC input
Input Reference Voltage on REFIN Pin, V <sub>REFIN</sub>		2.048		V	
Resolution		12		Bits	Endpoint corrected, V <sub>REFIN</sub> = 2.048 V
INL			±2.5	LSB	
Gain Error			±0.05	%	

Parameter	Min	Typ	Max	Unit	Test Conditions/Comments
Conversion Time		0.44		ms	One conversion on one channel
Offset Error		84		ms	All 12 channels selected, 16× averaging enabled
Input Noise		0.25	±2	LSB	$V_{REFIN} = 2.048\text{ V}$
				LSB rms	Direct input (no attenuator)
<b>TEMPERATURE SENSOR<sup>2</sup></b>					
Local Sensor Accuracy		±3		°C	VDDCAP = 4.75 V
Local Sensor Supply Voltage Coefficient		-1.7		°C/V	
Remote Sensor Accuracy		±3		°C	VDDCAP = 4.75 V
Remote Sensor Supply Voltage Coefficient		-3		°C	
Remote Sensor Current Source		200		µA	High level
		12		µA	Low level
Temperature for Code 0x800		0		°C	VDDCAP = 4.75 V
Temperature for Code 0xC00		128		°C	VDDCAP = 4.75 V
Temperature Resolution per Code		0.125		°C	
<b>BUFFERED VOLTAGE OUTPUT DACs</b>					
Resolution		8		Bits	
Code 0x80 Output Voltage					Six DACs are individually selectable for centering on one of four output voltage ranges
Range 1	0.592	0.6	0.603	V	
Range 2	0.796	0.8	0.803	V	
Range 3	0.996	1	1.003	V	
Range 4	1.246	1.25	1.253	V	
Output Voltage Range		601.25		mV	Same range, independent of center point
LSB Step Size		2.36		mV	
INL			±0.75	LSB	Endpoint corrected
DNL			±0.4	LSB	
Gain Error			1	%	
Maximum Load Current (Source)		100		µA	
Maximum Load Current (Sink)		100		µA	
Maximum Load Capacitance			50	pF	
Settling Time to 50 pF Load			2	µs	
Load Regulation		2.5		mV	Per mA
PSRR		60		dB	DC
		40		dB	100 mV step in 20 ns with 50 pF load
<b>REFERENCE OUTPUT</b>					
Reference Output Voltage	2.043	2.048	2.053	V	No load
Load Regulation		-0.25		mV	Sourcing current, $I_{DACMAX} = -100\text{ µA}$
		+0.25		mV	Sinking current, $I_{DACMAX} = +100\text{ µA}$
Minimum Load Capacitance	1			µF	Capacitor required for decoupling, stability
PSRR		60		dB	DC
<b>PROGRAMMABLE DRIVER OUTPUTS (PDOs)</b>					
High Voltage (Charge Pump) Mode (PDO1 to PDO6)					
Output Impedance		500		kΩ	
$V_{OH}$	11	12.5	14	V	$I_{OH} = 0\text{ µA}$
	10.5	12	13.5	V	$I_{OH} = 1\text{ µA}$
$I_{OUTAVG}$		20		µA	$2\text{ V} < V_{OH} < 7\text{ V}$
Standard (Digital Output) Mode (PDO1 to PDO10)					
$V_{OH}$	2.4			V	$V_{PU}$ (pull-up to VDDCAP or VPx) = 2.7 V, $I_{OH} = 0.5\text{ mA}$
			4.5	V	$V_{PU}$ to VPx = 6.0 V, $I_{OH} = 0\text{ mA}$
	$V_{PU} - 0.3$			V	$V_{PU} \leq 2.7\text{ V}$ , $I_{OH} = 0.5\text{ mA}$
$V_{OL}$	0		0.50	V	$I_{OL} = 20\text{ mA}$

Parameter	Min	Typ	Max	Unit	Test Conditions/Comments
$I_{OL}^3$			20	mA	Maximum sink current per PDOx pin
$I_{SINK}^3$			60	mA	Maximum total sink for all PDOx pins
$R_{PULL-UP}$	16	20	29	k $\Omega$	Internal pull-up
$I_{SOURCE} (VPx)^3$			2	mA	Current load on any VPx pull-ups, that is, total source current available through any number of PDOx pull-up switches configured onto any one VPx pin
Three-State Output Leakage Current			10	$\mu$ A	$V_{PDO} = 14.4$ V
Oscillator Frequency	90	100	110	kHz	All on-chip time delays derived from this clock
<b>DIGITAL INPUTS (VXx, A0, A1)</b>					
Input High Voltage, $V_{IH}$	2.0			V	Maximum $V_{IN} = 5.5$ V
Input Low Voltage, $V_{IL}$			0.8	V	Maximum $V_{IN} = 5.5$ V
Input High Current, $I_{IH}$	-1			$\mu$ A	$V_{IN} = 5.5$ V
Input Low Current, $I_{IL}$			1	$\mu$ A	$V_{IN} = 0$ V
Input Capacitance		5		pF	
Programmable Pull-Down Current, $I_{PULL-DOWN}$		20		$\mu$ A	$V_{DDCAP} = 4.75$ V $T_A = 25^\circ$ C if known logic state is required
<b>SERIAL BUS DIGITAL INPUTS (SDA, SCL)</b>					
Input High Voltage, $V_{IH}$	2.0			V	
Input Low Voltage, $V_{IL}$			0.8	V	
Output Low Voltage, $V_{OL}^3$			0.4	V	$I_{OUT} = -3.0$ mA
<b>SERIAL BUS TIMING<sup>4</sup></b>					
Clock Frequency, $f_{SCLK}$			400	kHz	
Bus Free Time, $t_{BUF}$	1.3			$\mu$ s	
Start Setup Time, $t_{SU,STA}$	0.6			$\mu$ s	
Stop Setup Time, $t_{SU,STO}$	0.6			$\mu$ s	
Start Hold Time, $t_{HD,STA}$	0.6			$\mu$ s	
SCL Low Time, $t_{LOW}$	1.3			$\mu$ s	
SCL High Time, $t_{HIGH}$	0.6			$\mu$ s	
SCL, SDA Rise Time, $t_r$			300	ns	
SCL, SDA Fall Time, $t_f$			300	ns	
Data Setup Time, $t_{SU,DAT}$	100			ns	
Data Hold Time, $t_{HD,DAT}$	5			ns	
Input Low Current, $I_{IL}$			1	$\mu$ A	$V_{IN} = 0$ V
<b>SEQUENCING ENGINE TIMING</b>					
State Change Time		10		$\mu$ s	

<sup>1</sup> At least one of the VH, VPx pins must be  $\geq 3.0$  V to maintain the device supply on VDDCAP.

<sup>2</sup> All temperature sensor measurements are taken with round-robin loop enabled and at least one other voltage input being measured.

<sup>3</sup> Specification is not production tested but is supported by characterization data at initial product release.

<sup>4</sup> Timing specifications are guaranteed by design and supported by characterization data.

## ABSOLUTE MAXIMUM RATINGS

Table 2.

Parameter	Rating
Voltage on VH Pin	16 V
Voltage on VPx Pins	7 V
Voltage on VXx Pins	-0.3 V to +6.5 V
Voltage on A0, A1 Pins	-0.3 V to +7 V
Voltage on REFIN, REFOUT Pins	5 V
Voltage on VDDCAP, VCCP Pins	6.5 V
Voltage on PDOx Pins	16 V
Voltage on SDA, SCL Pins	7 V
Voltage on GND, AGND, PDOGND, REFGND Pins	-0.3 V to +0.3 V
Voltage on DN, DP Pins	-0.3 V to +5 V
Input Current at Any Pin	±5 mA
Package Input Current	±20 mA
Maximum Junction Temperature (T <sub>j</sub> max)	150°C
Storage Temperature Range	-65°C to +150°C
Lead Temperature, Soldering Vapor Phase, 60 sec	215°C
ESD Rating, All Pins	2000 V

Stresses at or above those listed under Absolute Maximum Ratings may cause permanent damage to the product. This is a stress rating only; functional operation of the product at these or any other conditions above those indicated in the operational section of this specification is not implied. Operation beyond the maximum operating conditions for extended periods may affect product reliability.

## THERMAL RESISTANCE

$\theta_{JA}$  is specified for the worst-case conditions, that is, a device soldered in a circuit board for surface-mount packages.

Table 3. Thermal Resistance

Package Type	$\theta_{JA}$	Unit
40-Lead LFCSP	25	°C/W
48-Lead TQFP	50	°C/W

## ESD CAUTION



**ESD (electrostatic discharge) sensitive device.** Charged devices and circuit boards can discharge without detection. Although this product features patented or proprietary protection circuitry, damage may occur on devices subjected to high energy ESD. Therefore, proper ESD precautions should be taken to avoid performance degradation or loss of functionality.



# PIN CONFIGURATIONS AND FUNCTION DESCRIPTIONS



**NOTES**  
 1. THE LFCSP HAS AN EXPOSED PAD ON THE BOTTOM. THIS PAD IS A NO CONNECT (NC). IF POSSIBLE, THIS PAD SHOULD BE SOLDERED TO THE BOARD FOR IMPROVED MECHANICAL STABILITY.

Figure 3. 40-Lead LFCSP Pin Configuration

04433-003



**NOTES**  
 1. NC = NO CONNECT. DO NOT CONNECT TO THIS PIN.

Figure 4. 48-Lead TQFP Pin Configuration

04433-004

Table 4. Pin Function Descriptions

Pin No.		Mnemonic	Description
40-Lead LFCSP	48-Lead TQFP		
1 to 5	1, 12, 13, 24, 25, 36, 37, 48	NC	No Connect. Do not connect to this pin.
6 to 9	2 to 6	VX1 to VX5 (VXx)	High Impedance Inputs to Supply Fault Detectors. Fault thresholds can be set from 0.573 V to 1.375 V. Alternatively, these pins can be used as general-purpose digital inputs.
10	7 to 10	VP1 to VP4 (VPx)	Low Voltage Inputs to Supply Fault Detectors. Three input ranges can be set by altering the input attenuation on a potential divider connected to these pins, the output of which connects to a supply fault detector. These pins allow thresholds from 2.5 V to 6.0 V, from 1.25 V to 3.00 V, and from 0.573 V to 1.375 V.
11	11	VH	High Voltage Input to Supply Fault Detectors. Two input ranges can be set by altering the input attenuation on a potential divider connected to this pin, the output of which connects to a supply fault detector. This pin allows thresholds from 6.0 V to 14.4 V and from 2.5 V to 6.0 V.
12	14	AGND <sup>1</sup>	Ground Return for Input Attenuators.
13	15	REFGND <sup>1</sup>	Ground Return for On-Chip Reference Circuits.
14	16	REFIN	Reference Input for ADC. Nominally, 2.048 V. This pin must be driven by a reference voltage. The on-board reference can be used by connecting the REFOUT pin to the REFIN pin.
15 to 20	17	REFOUT	Reference Output, 2.048 V. Typically connected to REFIN. Note that the capacitor must be connected between this pin and REFGND. A 10 µF capacitor is recommended for this purpose.
21 to 30	18 to 23	DAC1 to DAC6	Voltage Output DACs. These pins default to high impedance at power-up.
31	26 to 35	PDO10 to PDO1	Programmable Output Drivers.
32	38	PDOGND <sup>1</sup>	Ground Return for Output Drivers.
33	39	VCCP	Central Charge Pump Voltage of 5.25 V. A reservoir capacitor must be connected between this pin and GND. A 10 µF capacitor is recommended for this purpose.
34	40	A0	Logic Input. This pin sets the seventh bit of the SMBus interface address.
35	41	A1	Logic Input. This pin sets the sixth bit of the SMBus interface address.
36	42	SCL	SMBus Clock Pin. Bidirectional open drain requires external resistive pull-up.
	43	SDA	SMBus Data Pin. Bidirectional open drain requires external resistive pull-up.

Pin No.		Mnemonic	Description
40-Lead LFCSP	48-Lead TQFP		
37	44	DN	External Temperature Sensor Cathode Connection.
38	45	DP	External Temperature Sensor Anode Connection.
39	46	VDDCAP	Device Supply Voltage. Linearly regulated from the highest of the VPx, VH pins to a typical of 4.75 V. Note that the capacitor must be connected between this pin and GND. A 10 $\mu$ F capacitor is recommended for this purpose.
40	47	GND <sup>1</sup>	Supply Ground.
	N/A <sup>2</sup>	EPAD	Exposed Pad. The LFCSP has an exposed pad on the bottom. This pad is a no connect (NC). If possible, this pad should be soldered to the board for improved mechanical stability.

<sup>1</sup> In a typical application, all ground pins are connected together.

<sup>2</sup> N/A is not applicable

### TYPICAL PERFORMANCE CHARACTERISTICS



Figure 5.  $V_{VDDCAP}$  vs.  $V_{VP1}$



Figure 8.  $I_{VP1}$  vs.  $V_{VP1}$  (VP1 Not as Supply)



Figure 6.  $V_{VDDCAP}$  vs.  $V_{VH}$



Figure 9.  $I_{VH}$  vs.  $V_{VH}$  (VH as Supply)



Figure 7.  $I_{VP1}$  vs.  $V_{VP1}$  (VP1 as Supply)



Figure 10.  $I_{VH}$  vs.  $V_{VH}$  (VH Not as Supply)

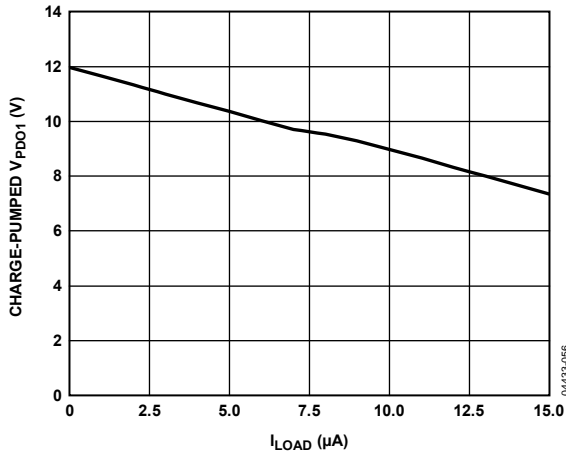

Figure 11. Charge-Pumped  $V_{PDO1}$  (FET Drive Mode) vs.  $I_{LOAD}$



Figure 14. DNL for ADC

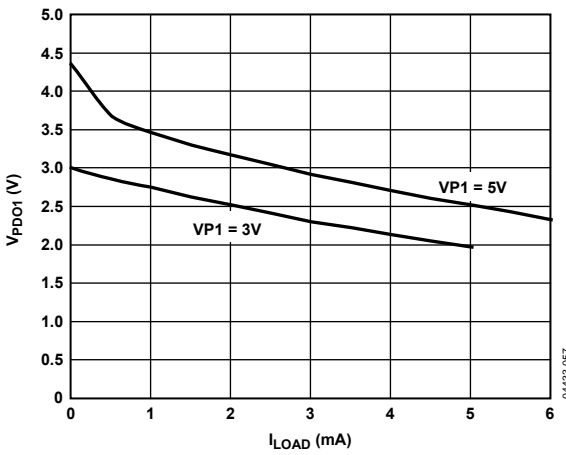

Figure 12.  $V_{PDO1}$  (Strong Pull-Up to  $VPx$ ) vs.  $I_{LOAD}$



Figure 15. INL for ADC

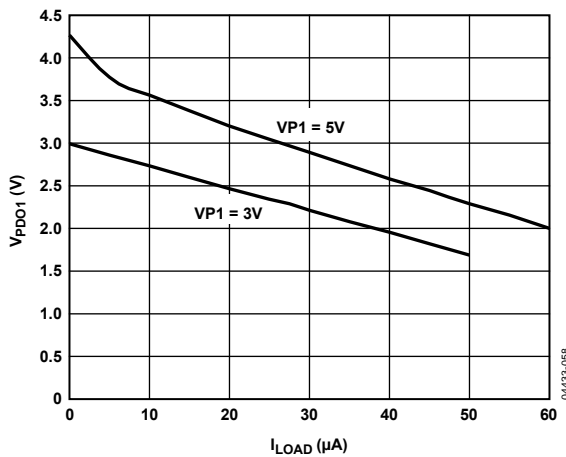

Figure 13.  $V_{PDO1}$  (Weak Pull-Up to  $VPx$ ) vs.  $I_{LOAD}$



Figure 16. ADC Noise, Midcode Input, 10,000 Reads



Figure 17. Transient Response of DAC Code Change into Typical Load

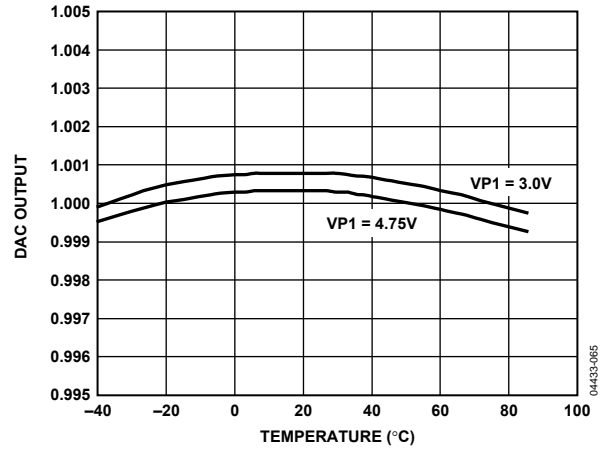

Figure 19. DAC Output vs. Temperature



Figure 18. Transient Response of DAC to Turn-On from High-Z State

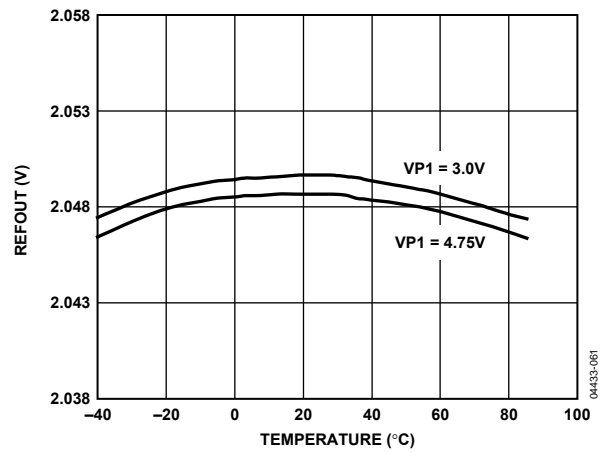

Figure 20. REFOUT vs. Temperature

## POWERING THE ADM1062

The ADM1062 is powered from the highest voltage input on either the positive-only supply inputs (VPx) or the high voltage supply input (VH). This technique offers improved redundancy because the device is not dependent on any particular voltage rail to keep it operational. The same pins are used for supply fault detection (see the Supply Supervision section). A  $V_{DD}$  arbitrator on the device chooses which supply to use. The arbitrator can be considered an ORing of five low dropout regulators (LDOs) together. A supply comparator chooses the highest input to provide the on-chip supply. There is minimal switching loss with this architecture ( $\sim 0.2$  V), resulting in the ability to power the ADM1062 from a supply as low as 3.0 V. Note that the supply on the VXX pins cannot be used to power the device.

An external capacitor to GND is required to decouple the on-chip supply from noise. This capacitor should be connected to the VDDCAP pin, as shown in Figure 21. The capacitor has another use during brownouts (momentary loss of power). Under these conditions, when the input supply (VPx or VH) dips transiently below  $V_{DD}$ , the synchronous rectifier switch immediately turns off so that it does not pull  $V_{DD}$  down. The  $V_{DD}$  capacitor can then act as a reservoir to keep the device active until the next highest supply takes over the powering of the device. A 10  $\mu$ F capacitor is recommended for this reservoir/decoupling function.

The VH input pin can accommodate supplies up to 14.4 V, which allows the ADM1062 to be powered using a 12 V backplane supply. In cases where this 12 V supply is hot swapped, it is recommended that the ADM1062 not be connected directly to the supply. Suitable precautions, such as the use of a hot swap controller, should be taken to protect the device from transients that could cause damage during hot swap events.

When two or more supplies are within 100 mV of each other, the supply that first takes control of  $V_{DD}$  keeps control. For example, if VP1 is connected to a 3.3 V supply,  $V_{DD}$  powers up to approximately 3.1 V through VP1. If VP2 is then connected to another 3.3 V supply, VP1 still powers the device, unless VP2 goes 100 mV higher than VP1.

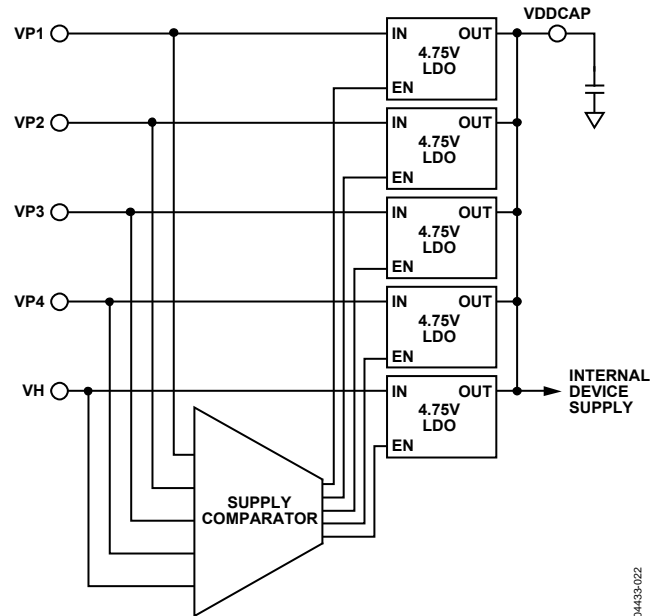

Figure 21.  $V_{DD}$  Arbitrator Operation

## SLEW RATE CONSIDERATION

When the ambient temperature of operation is less than approximately  $-20^{\circ}\text{C}$ , and in the event of a power loss where all supply inputs fail for less than a few hundreds of milliseconds (for example, due to a system supply brownout), it is recommended that the supply voltage recover with a ramp rate of at least 1.5 V/ms or less than 0.5 V/ms.

# INPUTS

## SUPPLY SUPERVISION

The ADM1062 has 10 programmable inputs. Five of these are dedicated supply fault detectors (SFDs). These dedicated inputs are called VH and VPx (VP1 to VP4) by default. The other five inputs are labeled VXx (VX1 to VX5) and have dual functionality. They can be used either as SFDs, with functionality similar to VH and VPx, or as CMOS-/TTL-compatible logic inputs to the device. Therefore, the ADM1062 can have up to 10 analog inputs, a minimum of five analog inputs and five digital inputs, or a combination thereof. If an input is used as an analog input, it cannot be used as a digital input. Therefore, a configuration requiring 10 analog inputs has no available digital inputs. Table 6 shows the details of each input.

## PROGRAMMING THE SUPPLY FAULT DETECTORS

The ADM1062 can have up to 10 SFDs on its 10 input channels. These highly programmable reset generators enable the supervision of up to 10 supply voltages. The supplies can be as low as 0.573 V and as high as 14.4 V. The inputs can be configured to detect an undervoltage fault (the input voltage drops below a preprogrammed value), an overvoltage fault (the input voltage rises above a preprogrammed value), or an out-of-window fault (the input voltage is outside a preprogrammed range). The thresholds can be programmed to an 8-bit resolution in registers provided in the ADM1062. This translates to a voltage resolution that is dependent on the range selected.

The resolution is given by

$$\text{Step Size} = \text{Threshold Range}/255$$

Therefore, if the high range is selected on VH, the step size can be calculated as follows:

$$(14.4 \text{ V} - 6.0 \text{ V})/255 = 32.9 \text{ mV}$$

Table 5 lists the upper and lower limits of each available range, the bottom of each range ( $V_B$ ), and the range itself ( $V_R$ ).

**Table 5. Voltage Range Limits**

Voltage Range (V)	$V_B$ (V)	$V_R$ (V)
0.573 to 1.375	0.573	0.802
1.25 to 3.00	1.25	1.75
2.5 to 6.0	2.5	3.5
6.0 to 14.4	6.0	8.4

**Table 6. Input Functions, Thresholds, and Ranges**

Input	Function	Voltage Range (V)	Maximum Hysteresis	Voltage Resolution (mV)	Glitch Filter ( $\mu$ s)
VH	High Voltage Analog Input	2.5 to 6.0	425 mV	13.7	0 to 100
		6.0 to 14.4	1.02 V	32.9	0 to 100
VPx	Positive Analog Input	0.573 to 1.375	97.5 mV	3.14	0 to 100
		1.25 to 3.00	212 mV	6.8	0 to 100
		2.5 to 6.0	425 mV	13.7	0 to 100
VXx	High-Z Analog Input	0.573 to 1.375	97.5 mV	3.14	0 to 100
		Digital Input	0 to 5.0	N/A	N/A

The threshold value required is given by

$$V_T = (V_R \times N)/255 + V_B$$

where:

$V_T$  is the desired threshold voltage (undervoltage or overvoltage).

$V_R$  is the voltage range.

$N$  is the decimal value of the 8-bit code.

$V_B$  is the bottom of the range.

Reversing the equation, the code for a desired threshold is given by

$$N = 255 \times (V_T - V_B)/V_R$$

For example, if the user wants to set a 5 V overvoltage threshold on VP1, the code to be programmed in the PSIOVTH register (as discussed in the AN-698 Application Note) is given by

$$N = 255 \times (5 - 2.5)/3.5$$

Therefore,  $N = 182$  (1011 0110 or 0xB6).

## INPUT COMPARATOR HYSTERESIS

The UV and OV comparators shown in Figure 22 are always monitoring VPx. To avoid chatter (multiple transitions when the input is very close to the set threshold level), these comparators have digitally programmable hysteresis. The hysteresis can be programmed up to the values shown in Table 6.



Figure 22. Supply Fault Detector Block

The hysteresis is added after a supply voltage goes out of tolerance. Therefore, the user can program the amount above the undervoltage threshold to which the input must rise before an undervoltage fault is deasserted. Similarly, the user can program the amount below the overvoltage threshold to which an input must fall before an overvoltage fault is deasserted.

The hysteresis value is given by

$$V_{HYST} = V_R \times N_{THRESH}/255$$

where:

$V_{HYST}$  is the desired hysteresis voltage.

$N_{THRESH}$  is the decimal value of the 5-bit hysteresis code.

Note that  $N_{THRESH}$  has a maximum value of 31. The maximum hysteresis for the ranges is listed in Table 6.

## INPUT GLITCH FILTERING

The final stage of the SFDs is a glitch filter. This block provides time-domain filtering on the output of the SFD comparators, which allows the user to remove any spurious transitions, such as supply bounce at turn-on. The glitch filter function is in addition to the digitally programmable hysteresis of the SFD comparators. The glitch filter timeout is programmable up to 100  $\mu$ s.

For example, when the glitch filter timeout is 100  $\mu$ s, any pulse appearing on the input of the glitch filter block that is less than 100  $\mu$ s in duration is prevented from appearing on the output of the glitch filter block. Any input pulse that is longer than 100  $\mu$ s appears on the output of the glitch filter block. The output is delayed with respect to the input by 100  $\mu$ s. The filtering process is shown in Figure 23.

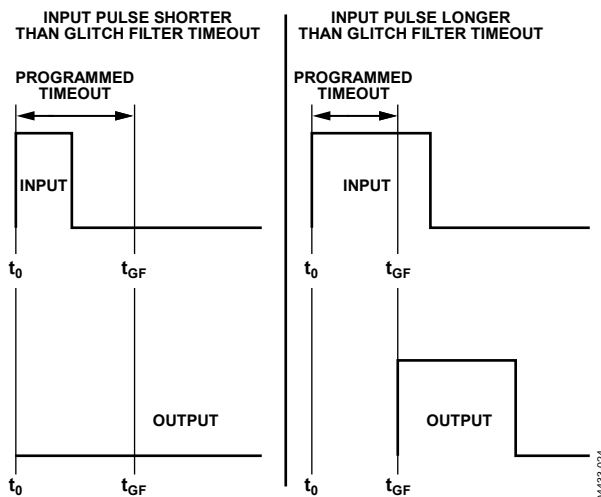

Figure 23. Input Glitch Filter Function

## VP1 Glitch Filtering

If the ADC round-robin is used, it is recommended to enable glitch filtering on VP1 because the ADC input mux is connected to VP1 when the ADC round-robin stops. When the ADC round-robin stops, a small internal glitch on the VP1 monitor rail occurs, and if the rail is close to the UV threshold, it may be enough to trip the VP1 UV comparator. Use any value of glitch filter greater than 0  $\mu$ s to avoid false UV triggers. For more information about the ADC round-robin, see the Voltage Readback section.

## SUPPLY SUPERVISION WITH VXx INPUTS

The VXx inputs have two functions. They can be used as either supply fault detectors or digital logic inputs. When selected as analog (SFD) inputs, the VXx pins have functionality that is very similar to the VH and VPx pins. The primary difference is that the VXx pins have only one input range: 0.573 V to 1.375 V. Therefore, these inputs can directly supervise only the very low supplies. However, the input impedance of the VXx pins is high, allowing an external resistor divide network to be connected to the pin. Thus, potentially any supply can be divided down into the input range of the VXx pin and supervised, enabling the ADM1062 to monitor other supplies, such as +24 V, +48 V, and -5 V.

An additional supply supervision function is available when the VXx pins are selected as digital inputs. In this case, the analog function is available as a second detector on each of the dedicated analog inputs, VPx and VH. The analog function of VX1 is mapped to VP1, VX2 is mapped to VP2, and so on; VX5 is mapped to VH. In this case, these SFDs can be viewed as secondary or warning SFDs.

The secondary SFDs are fixed to the same input range as the primary SFDs. They are used to indicate warning levels rather than failure levels. This allows faults and warnings to be generated on a single supply using only one pin. For example, if VP1 is set to output a fault when a 3.3 V supply drops to 3.0 V, VX1 can be set to output a warning at 3.1 V. Warning outputs are available for readback from the status registers. They are also ORed together and fed into the SE, allowing warnings to generate interrupts on the PDOs. Therefore, in this example, if the supply drops to 3.1 V, a warning is generated and remedial action can be taken before the supply drops out of tolerance.



### VXx PINS AS DIGITAL INPUTS

As discussed in the Supply Supervision with VXx Inputs section, the VXx input pins on the ADM1062 have dual functionality. The second function is as a digital logic input to the device. Therefore, the ADM1062 can be configured for up to five digital inputs. These inputs are TTL-/CMOS-compatible. Standard logic signals can be applied to the pins: RESET from reset generators, PWRGD signals, fault flags, manual resets, and so on. These signals are available as inputs to the SE and, therefore, can be used to control the status of the PDOs. The inputs can be configured to detect either a change in level or an edge.

When configured for level detection, the output of the digital block is a buffered version of the input. When configured for edge detection, a pulse of programmable width is output from the digital block once the logic transition is detected. The width is programmable from 0  $\mu$ s to 100  $\mu$ s.

The digital blocks feature the same glitch filter function that is available on the SFDs. This function enables the user to ignore spurious transitions on the inputs. For example, the filter can be used to debounce a manual reset switch.

When configured as digital inputs, each VXx pin has a weak (10  $\mu$ A) pull-down current source available for placing the input into a known condition, even if left floating. The current source, if selected, weakly pulls the input to GND.



Figure 24. VXx Digital Input Function

04433-027

## OUTPUTS

### SUPPLY SEQUENCING THROUGH CONFIGURABLE OUTPUT DRIVERS

Supply sequencing is achieved with the [ADM1062](#) using the programmable driver outputs (PDOs) on the device as control signals for supplies. The output drivers can be used as logic enables or as FET drivers.

The sequence in which the PDOs are asserted (and, therefore, the supplies are turned on) is controlled by the sequencing engine (SE). The SE determines what action is taken with the PDOs, based on the condition of the [ADM1062](#) inputs. Therefore, the PDOs can be set up to assert when the SFDs are in tolerance, the correct input signals are received on the VXx digital pins, no warnings are received from any of the inputs of the device, and at other times. The PDOs can be used for a variety of functions. The primary function is to provide enable signals for LDOs or dc-to-dc converters that generate supplies locally on a board. The PDOs can also be used to provide a PWRGD signal, when all the SFDs are in tolerance, or a RESET output if one of the SFDs goes out of specification (this can be used as a status signal for a DSP, FPGA, or other microcontroller).

The PDOs can be programmed to pull up to a number of different options. The outputs can be programmed as follows:

- Open-drain (allowing the user to connect an external pull-up resistor).
- Open-drain with weak pull-up to  $V_{DD}$ .
- Open-drain with strong pull-up to  $V_{DD}$ .
- Open-drain with weak pull-up to  $VPx$ .
- Open-drain with strong pull-up to  $VPx$ .
- Strong pull-down to GND.
- Internally charge-pumped high drive (12 V, PDO1 to PDO6 only).

The last option (available only on PDO1 to PDO6) allows the user to directly drive a voltage high enough to fully enhance an external N-FET, which is used to isolate, for example, a card-side voltage from a backplane supply (a PDO can sustain greater than 10.5 V into a 1  $\mu$ A load). The pull-down switches can also be used to drive status LEDs directly.

The data driving each of the PDOs can come from one of three sources. The source can be enabled in the PDOxCFG configuration register (see the [AN-698 Application Note](#) for details).

The data sources are as follows:

- Output from the SE.
- Directly from the SMBus. A PDO can be configured so that the SMBus has direct control over it. This enables software control of the PDOs. Therefore, a microcontroller can be used to initiate a software power-up/power-down sequence.
- On-chip clock. A 100 kHz clock is generated on the device. This clock can be made available on any of the PDOs. It can be used, for example, to clock an external device such as an LED.

### DEFAULT OUTPUT CONFIGURATION

All of the internal registers in an unprogrammed [ADM1062](#) device from the factory are set to 0. Because of this, the PDOx pins are pulled to GND by a weak (20 k $\Omega$ ) on-chip pull-down resistor.

As the input supply to the [ADM1062](#) ramps up on  $VPx$  or  $VH$ , all the PDOx pins behave as follows:

- Input supply = 0 V to 1.2 V. The PDOs are high impedance.
- Input supply = 1.2 V to 2.7 V. The PDOs are pulled to GND by a weak (20 k $\Omega$ ) on-chip pull-down resistor.
- Supply > 2.7 V. Factory-programmed devices continue to pull all PDOs to GND by a weak (20 k $\Omega$ ) on-chip pull-down resistor. Programmed devices download current EEPROM configuration data, and the programmed setup is latched. The PDO then goes to the state demanded by the configuration. This provides a known condition for the PDOs during power-up.

The internal pull-down can be overdriven with an external pull-up of suitable value tied from the PDOx pin to the required pull-up voltage. The 20 k $\Omega$  resistor must be accounted for in calculating a suitable value. For example, if PDOx must be pulled up to 3.3 V, and 5 V is available as an external supply, the pull-up resistor value is given by

$$3.3 \text{ V} = 5 \text{ V} \times 20 \text{ k}\Omega / (R_{UP} + 20 \text{ k}\Omega)$$

Therefore,

$$R_{UP} = (100 \text{ k}\Omega - 66 \text{ k}\Omega) / 3.3 \text{ V} = 10 \text{ k}\Omega$$



Figure 25. Programmable Driver Output

# SEQUENCING ENGINE

## OVERVIEW

The ADM1062 sequencing engine (SE) provides the user with powerful and flexible control of sequencing. The SE implements a state machine control of the PDO outputs, with state changes conditional on input events. SE programs can enable complex control of boards, including power-up and power-down sequence control, fault event handling, and interrupt generation on warnings. A watchdog function that verifies the continued operation of a processor clock can be integrated into the SE program. The SE can also be controlled via the SMBus, giving software or firmware control of the board sequencing.

The SE state machine comprises 63 state cells. Each state has the following attributes:

- Monitors signals indicating the status of the 10 input pins, VP1 to VP4, VH, and VX1 to VX5.
- Can be entered from any other state.
- Three exit routes move the state machine onto the next state: sequence detection, fault monitoring, and timeout.
- Delay timers for the sequence and timeout blocks can be programmed independently and changed with each state change. The range of timeouts is from 0 ms to 400 ms.
- Output condition of the 10 PDO pins is defined and fixed within a state.
- Transition from one state to the next is made in less than 20 μs, which is the time needed to download a state definition from EEPROM to the SE.



Figure 26. State Cell

The ADM1062 offers up to 63 state definitions. The signals monitored to indicate the status of the input pins are the outputs of the SFDs.

## WARNINGS

The SE also monitors warnings. These warnings can be generated when the ADC readings violate their limit register value or when the secondary voltage monitors on VPx and VH are triggered. The warnings are ORed together and are available as a single warning input to each of the three blocks that enable exiting a state.

## SMBus JUMP (UNCONDITIONAL JUMP)

The SE can be forced to advance to the next state unconditionally. This enables the user to force the SE to advance. Examples of the use of this feature include moving to a margining state or debugging a sequence. The SMBus jump or go-to command can be seen as another input to sequence and timeout blocks to provide an exit from each state.

Table 7. Sample Sequence State Entries

State	Sequence	Timeout	Monitor
IDLE1	If VX1 is low, go to State IDLE2.		
IDLE2	If VP1 is okay, go to State EN3V3.		
EN3V3	If VP2 is okay, go to State EN2V5.	If VP2 is not okay after 10 ms, go to State DIS3V3.	If VP1 is not okay, go to State IDLE1.
DIS3V3	If VX1 is high, go to State IDLE1.		
EN2V5	If VP3 is okay, go to State PWRGD.	If VP3 is not okay after 20 ms, go to State DIS2V5.	If VP1 or VP2 is not okay, go to State FSEL2.
DIS2V5	If VX1 is high, go to State IDLE1.		
FSEL1	If VP3 is not okay, go to State DIS2V5.		If VP1 or VP2 is not okay, go to State FSEL2.
FSEL2	If VP2 is not okay, go to State DIS3V3.		If VP1 is not okay, go to State IDLE1.
PWRGD	If VX1 is high, go to State DIS2V5.		If VP1, VP2, or VP3 is not okay, go to State FSEL1.

**SEQUENCING ENGINE APPLICATION EXAMPLE**

The application in this section demonstrates operation of the SE. Figure 28 shows how the simple building block of a single SE state can be used to build a power-up sequence for a three-supply system. Table 8 lists the PDO outputs for each state in the same SE implementation. In this system, a good 5 V supply on the VP1 pin and the VX1 pin held low are the triggers required to start a power-up sequence. The sequence next turns on the 3.3 V supply, then the 2.5 V supply (assuming successful turn-on of the 3.3 V supply). When all three supplies are have turned on correctly, the PWRGD state is entered, where the SE remains until a fault occurs on one of the three supplies, or until it is instructed to go through a power-down sequence by VX1 going high.

Faults are dealt with throughout the power-up sequence on a case-by-case basis. The following three sections (the Sequence Detector section, the Monitoring Fault Detector section, and the Timeout Detector section) describe the individual blocks and use the sample application shown in Figure 28 to demonstrate the actions of the state machine.

**Sequence Detector**

The sequence detector block is used to detect when a step in a sequence has been completed. It looks for one of the SE inputs to change state and is most often used as the gate for successful progress through a power-up or power-down sequence. A timer block that is included in this detector can insert delays into a power-up or power-down sequence, if required. Timer delays can be set from 10 μs to 400 ms. Figure 27 is a block diagram of the sequence detector.

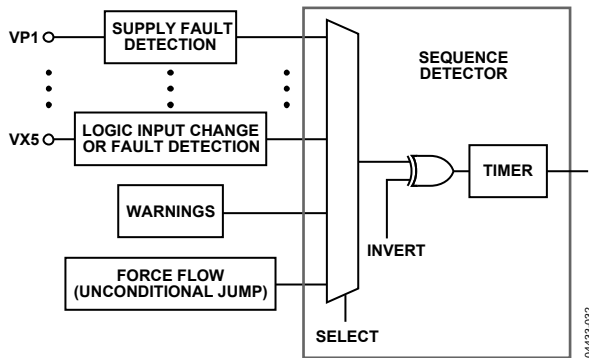

Figure 27. Sequence Detector Block Diagram

If a timer delay is specified, the input to the sequence detector must remain in the defined state for the duration of the timer delay. If the input changes state during the delay, the timer is reset.

The sequence detector can also help to identify monitoring faults. In the sample application shown in Figure 28, the FSEL1 and FSEL2 states first identify which of the VP1, VP2, or VP3 has faulted, and then they take appropriate action.

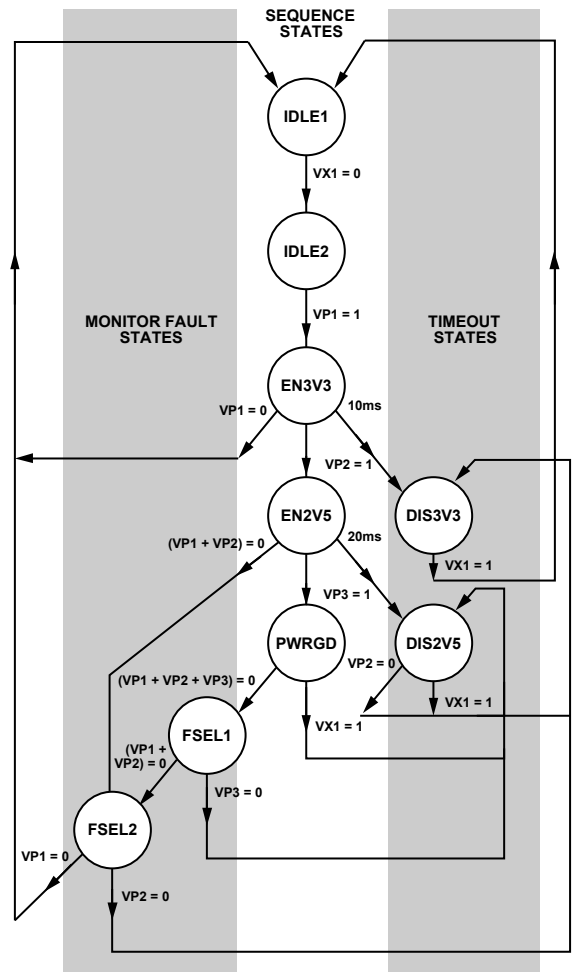

Figure 28. Sample Application Flow Diagram

**Table 8. PDO Outputs for Each State**

PDO Outputs	IDLE1	IDLE2	EN3V3	EN2V5	DIS3V3	DIS2V5	PWRGD	FSEL1	FSEL2
PDO1 = 3V3ON	0	0	1	1	0	1	1	1	1
PDO2 = 2V5ON	0	0	0	1	1	0	1	1	1
PDO3 = FAULT	0	0	0	0	1	1	0	1	1

### Monitoring Fault Detector

The monitoring fault detector block is used to detect a failure on an input. The logical function implementing this is a wide OR gate that can detect when an input deviates from its expected condition. The clearest demonstration of the use of this block is in the PWRGD state, where the monitor block indicates that a failure on one or more of the VP1, VP2, or VP3 inputs has occurred.

No programmable delay is available in this block because the triggering of a fault condition is likely to be caused by a supply falling out of tolerance. In this situation, the device needs to react as quickly as possible.

Some latency occurs when moving out of this state because it takes a finite amount of time (~20  $\mu$ s) for the state configuration to download from the EEPROM into the SE. Figure 29 is a block diagram of the monitoring fault detector.

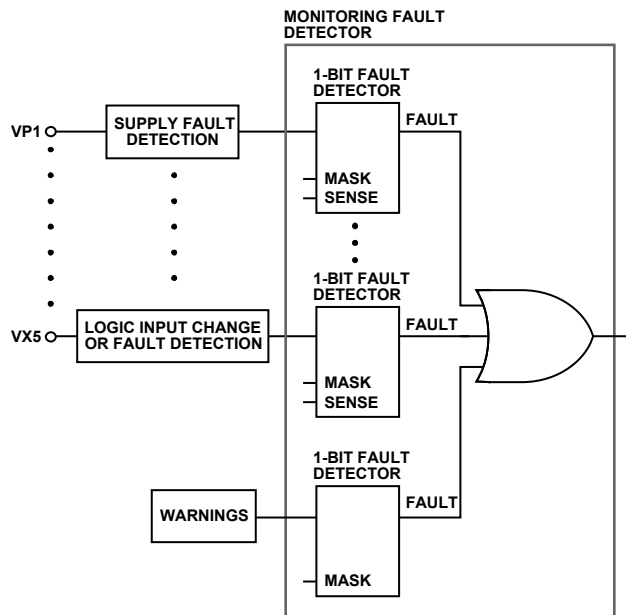

Figure 29. Monitoring Fault Detector Block Diagram

### Timeout Detector

The timeout detector allows the user to trap a failure to ensure proper progress through a power-up or power-down sequence.

In the sample application shown in Figure 28, the timeout next-state transition is from the EN3V3 and EN2V5 states. For the EN3V3 state, the signal 3V3ON is asserted on the PDO1 output pin upon entry to this state to turn on a 3.3 V supply. This supply rail is connected to the VP2 pin, and the sequence detector looks for the VP2 pin to go above its undervoltage threshold, which is set in the supply fault detector (SFD) attached to that pin.

The power-up sequence progresses when this change is detected. If, however, the supply fails (perhaps due to a short circuit overloading this supply), the timeout block traps the problem. In this example, if the 3.3 V supply fails within 10 ms, the SE moves to the DIS3V3 state and turns off this supply by bringing PDO1 low. It also indicates that a fault has occurred by taking PDO3 high. Timeout delays of 100  $\mu$ s to 400 ms can be programmed.

### FAULT AND STATUS REPORTING

The ADM1062 has a fault latch for recording faults. Two registers, FSTAT1 and FSTAT2, are set aside for this purpose. A single bit is assigned to each input of the device, and a fault on that input sets the relevant bit. The contents of the fault register can be read out over the SMBus to determine which input(s) faulted. The fault register can be enabled or disabled in each state. To latch data from one state, ensure that the fault latch is disabled in the following state. This ensures that only real faults are captured and not, for example, undervoltage conditions that may be present during a power-up or power-down sequence.

The ADM1062 also has a number of status registers. These include more detailed information, such as whether an undervoltage or overvoltage fault is present on a particular input. The status registers also include information on ADC limit faults. Note that the data in the status registers is not latched in any way and, therefore, is subject to change at any time.

See the [AN-698 Application Note](#) for full details about the ADM1062 registers.

## VOLTAGE READBACK

The **ADM1062** has an on-board, 12-bit, accurate ADC for voltage readback over the SMBus. The ADC has a 12-channel analog mux on the front end. The 12 channels consist of the 10 SFD inputs (VH, VPx, and VXx), plus two channels for temperature readback (see the Temperature Measurement System section). Any or all of these inputs can be selected to be read, in turn, by the ADC. The circuit controlling this operation is called the ADC round-robin. This circuit can be selected to run through its loop of conversions once or continuously. Averaging is also provided for each channel. In this case, the ADC round-robin runs through its loop of conversions 16 times before returning a result for each channel. At the end of this cycle, the results are written to the output registers.

The ADC samples single-sided inputs with respect to the AGND pin. A 0 V input gives out Code 0, and an input equal to the voltage on REFIN gives out full code (4095 decimal).

The inputs to the ADC come directly from the VXx pins and from the back of the input attenuators on the VPx and VH pins, as shown in Figure 30 and Figure 31.

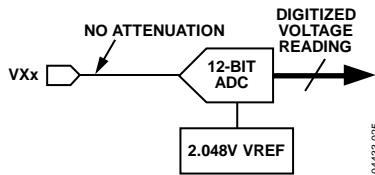

Figure 30. ADC Reading on VXx Pins

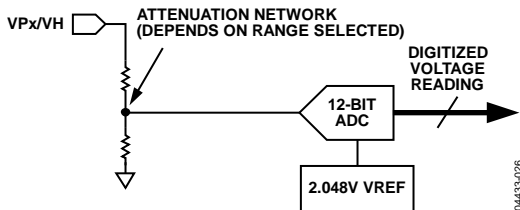

Figure 31. ADC Reading on VPx/VH Pins

The voltage at the input pin can be derived from the following equation:

$$V = \frac{\text{ADC Code}}{4095} \times \text{Attenuation Factor} \times V_{\text{REFIN}}$$

where  $V_{\text{REFIN}} = 2.048 \text{ V}$  when the internal reference is used (that is, the REFIN pin is connected to the REFOUT pin).

The ADC input voltage ranges for the SFD input ranges are listed in Table 9.

Table 9. ADC Input Voltage Ranges

SFD Input Range (V)	Attenuation Factor	ADC Input Voltage Range (V)
0.573 to 1.375	1	0 to 2.048
1.25 to 3.00	2.181	0 to 4.46
2.5 to 6.0	4.363	0 to 6.0 <sup>1</sup>
6.0 to 14.4	10.472	0 to 14.4 <sup>1</sup>

<sup>1</sup> The upper limit is the absolute maximum allowed voltage on the VPx and VH pins.

The typical way to supply the reference to the ADC on the REFIN pin is to connect the REFOUT pin to the REFIN pin. REFOUT provides a 2.048 V reference. As such, the supervising range covers less than half the normal ADC range. It is possible, however, to provide the ADC with a more accurate external reference for improved readback accuracy.

Supplies can also be connected to the input pins purely for ADC readback, even though these pins may go above the expected supervisory range limits (but not above the absolute maximum ratings on these pins). For example, a 1.5 V supply connected to the VX1 pin can be correctly read out as an ADC code of approximately 3/4 full scale, but it always sits above any supervisory limits that can be set on that pin. The maximum setting for the REFIN pin is 2.048 V.

## SUPPLY SUPERVISION WITH THE ADC

In addition to the readback capability, another level of supervision is provided by the on-chip, 12-bit ADC. The **ADM1062** has limit registers with which the user can program a maximum or minimum allowable threshold. Exceeding the threshold generates a warning that can either be read back from the status registers or input into the SE to determine what sequencing action the **ADM1062** should take. Only one register is provided for each input channel. Therefore, either an undervoltage threshold or overvoltage threshold (but not both) can be set for a given channel. The ADC round-robin can be enabled via an SMBus write, or it can be programmed to turn on in any state in the SE program. For example, it can be set to start after a power-up sequence is complete, and all supplies are known to be within expected tolerance limits.

Note that a latency is built into this supervision, dictated by the conversion time of the ADC. With all 12 channels selected, the total time for the round-robin operation (averaging off) is approximately 6 ms (500  $\mu\text{s}$  per channel selected). Supervision using the ADC, therefore, does not provide the same real-time response as the SFDs.

## SUPPLY MARGINING

### OVERVIEW

It is often necessary for the system designer to adjust supplies, either to optimize their level or force them away from nominal values to characterize the system performance under these conditions. This is a function typically performed during an in-circuit test (ICT), such as when a manufacturer wants to guarantee that a product under test functions correctly at nominal supplies minus 10%.

### OPEN-LOOP SUPPLY MARGINING

The simplest method of margining a supply is to implement an open-loop technique (see Figure 32). A popular way to do this is to switch extra resistors into the feedback node of a power module, such as a dc-to-dc converter or LDO. The extra resistor alters the voltage at the feedback or trim node and forces the output voltage to margin up or down by a certain amount.

The ADM1062 can perform open-loop margining for up to six supplies. The six on-board voltage DACs (DAC1 to DAC6) can drive into the feedback pins of the power modules to be margined. The simplest circuit to implement this function is an attenuation resistor that connects the DACx pin to the feedback node of a dc-to-dc converter. When the DACx output voltage is set equal to the feedback voltage, no current flows into the attenuation resistor, and the dc-to-dc converter output voltage does not change. Taking DACx above the feedback voltage forces current into the feedback node, and the output of the dc-to-dc converter is forced to fall to compensate for this. The dc-to-dc converter output can be forced high by setting the DACx output voltage lower than the feedback node voltage. The series resistor can be split in two, and the node between them can be decoupled with a capacitor to ground. This can help to decouple any noise picked up from the board. Decoupling to a ground local to the dc-to-dc converter is recommended.

The ADM1062 can be commanded to margin a supply up or down over the SMBus by updating the values on the relevant DAC output.

### CLOSED-LOOP SUPPLY MARGINING

A more accurate and comprehensive method of margining is to implement a closed-loop system (see Figure 33). The voltage on the rail to be margined can be read back to accurately margin the rail to the target voltage. The ADM1062 incorporates all the circuits required to do this, with the 12-bit successive approximation ADC used to read back the level of the supervised voltages, and the six voltage output DACs, implemented as described in the Open-Loop Supply Margining section, used to adjust supply levels. These circuits can be used along with other intelligence, such as a microcontroller, to implement a closed-loop margining system that allows any dc-to-dc converter or LDO supply to be set to any voltage, accurate to within  $\pm 0.5\%$  of the target.

To implement closed-loop margining

1. Disable the six DACx outputs.
2. Set the DAC output voltage equal to the voltage on the feedback node.
3. Enable the DAC.
4. Read the voltage at the dc-to-dc converter output that is connected to one of the VPx, VH, or VXx pins.
5. If necessary, modify the DACx output code up or down to adjust the dc-to-dc converter output voltage. Otherwise, stop because the target voltage has been reached.
6. Set the DAC output voltage to a value that alters the supply output by the required amount (for example,  $\pm 5\%$ ).
7. Repeat Step 4 through Step 6 until the measured supply reaches the target voltage.

Step 1 to Step 3 ensure that when the DACx output buffer is turned on, it has little effect on the dc-to-dc converter output. The DAC output buffer is designed to power up without glitching by first powering up the buffer to follow the pin voltage. It does not drive out onto the pin at this time. Once the output buffer is properly enabled, the buffer input is switched over to the DAC, and the output stage of the buffer is turned on. Output glitching is negligible.



Figure 32. Open-Loop Margining System Using the ADM1062

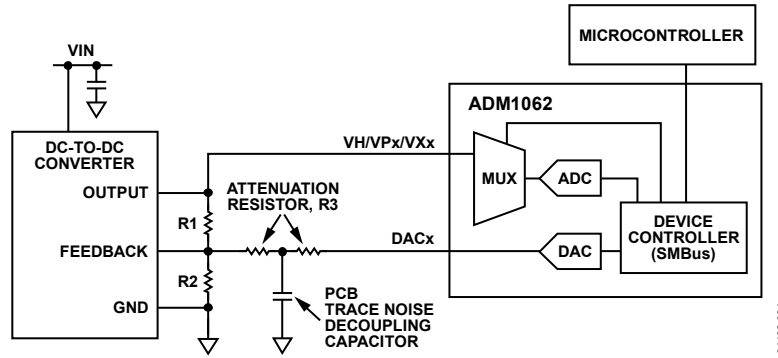

Figure 33. Closed-Loop Margining System Using the ADM1062

## WRITING TO THE DACS

Four DAC ranges are offered. They can be placed with midcode (Code 0x7F) at 0.6 V, 0.8 V, 1.0 V, and 1.25 V. These voltages are placed to correspond to the most common feedback voltages. Centering the DAC outputs in this way provides the best use of the DAC resolution. For most supplies, it is possible to place the DAC midcode at the point where the dc-to-dc converter output is not modified, thereby giving half of the DAC range to margin up and the other half to margin down.

The DAC output voltage is set by the code written to the DACx register. The voltage is linear with the unsigned binary number in this register. Code 0x7F is placed at the midcode voltage, as described previously. The output voltage is given by the following equation:

$$DAC\ Output = (DACx - 0x7F)/255 \times 0.6015 + V_{OFF}$$

where  $V_{OFF}$  is one of the four offset voltages.

There are 256 DAC settings available. The midcode value is located at DAC Code 0x7F, as close as possible to the middle of the 256 code range. The full output swing of the DACs is +302 mV (+128 codes) and -300 mV (-127 codes) around the selected midcode voltage. The voltage range for each midcode voltage is shown in Table 10.

Table 10. Ranges for Midcode Voltages

Midcode Voltage (V)	Minimum Voltage Output (V)	Maximum Voltage Output (V)
0.6	0.300	0.902
0.8	0.500	1.102
1.0	0.700	1.302
1.25	0.950	1.552

## CHOOSING THE SIZE OF THE ATTENUATION RESISTOR

The size of the attenuation resistor, R3, determines how much the DAC voltage swing affects the output voltage of the dc-to-dc converter that is being margined (see Figure 33).

Because the voltage at the feedback pin remains constant, the current flowing from the feedback node to GND through R2 is a constant. In addition, the feedback node itself is high impedance. This means that the current flowing through R1 is the same as

the current flowing through R3. Therefore, a direct relationship exists between the extra voltage drop across R1 during margining and the voltage drop across R3.

This relationship is given by the following equation:

$$\Delta V_{OUT} = \frac{R1}{R3} (V_{FB} - V_{DACOUT})$$

where:

$\Delta V_{OUT}$  is the change in  $V_{OUT}$ .

$V_{FB}$  is the voltage at the feedback node of the dc-to-dc converter.

$V_{DACOUT}$  is the voltage output of the margining DAC.

This equation demonstrates that if the user wants the output voltage to change by  $\pm 300$  mV, then  $R1 = R3$ . If the user wants the output voltage to change by  $\pm 600$  mV, then  $R1 = 2 \times R3$ , and so on.

It is best to use the full DAC output range to margin a supply. Choosing the attenuation resistor in this way provides the most resolution from the DAC, meaning that with one DAC code change, the smallest effect on the dc-to-dc converter output voltage is induced. If the resistor is sized up to use a code such as 27 decimal to 227 decimal to move the dc-to-dc converter output by  $\pm 5\%$ , it takes 100 codes to move 5% (each code moves the output by 0.05%). This is beyond the readback accuracy of the ADC, but it should not prevent the user from building a circuit to use the most resolution.

## DAC LIMITING AND OTHER SAFETY FEATURES

Limit registers (called DPLIMx and DNLMx) on the device offer the user some protection from firmware bugs that can cause catastrophic board problems by forcing supplies beyond their allowable output ranges. Essentially, the DAC code written into the DACx register is clipped such that the code used to set the DAC voltage is given by

DAC Code

= DACx, DACx  $\geq$  DNLMx and DACx  $\leq$  DPLIMx

= DNLMx, DACx < DNLMx

= DPLIMx, DACx > DPLIMx

In addition, the DAC output buffer is three-stated if DNLMx > DPLIMx. By programming the limit registers this way, the user can make it very difficult for the DAC output buffers to be turned on during normal system operation. The limit registers are among the registers downloaded from the EEPROM at startup.



## TEMPERATURE MEASUREMENT SYSTEM

The ADM1062 contains an on-chip, band gap temperature sensor whose output is digitized by the on-chip, 12-bit ADC. Theoretically, the temperature sensor and the ADC can measure temperatures from  $-128^{\circ}\text{C}$  to  $+128^{\circ}\text{C}$  with a resolution of  $0.125^{\circ}\text{C}$ . Because this exceeds the operating temperature range of the device, local temperature measurements outside this range are not possible. Temperature measurements from  $-128^{\circ}\text{C}$  to  $+128^{\circ}\text{C}$  are possible using a remote sensor. The output code is in offset binary format, with  $-128^{\circ}\text{C}$  given by Code  $0x400$ ,  $0^{\circ}\text{C}$  given by Code  $0x800$ , and  $+128^{\circ}\text{C}$  given by Code  $0xC00$ .

As with the other analog inputs to the ADC, a limit register is provided for each of the temperature input channels. Therefore, a temperature limit can be set such that if it is exceeded, a warning is generated and available as an input to the sequencing engine. This enables users to control their sequence or monitor functions based on an overtemperature or undertemperature event.

### REMOTE TEMPERATURE MEASUREMENT

The ADM1062 can measure the temperature of a remote diode sensor or diode-connected transistor connected to Pin DN and Pin DP (Pin 37 and Pin 38 on the LFCSP package and Pin 44 and Pin 45 on the TQFP package).

The forward voltage of a diode or diode-connected transistor operated at a constant current exhibits a negative temperature coefficient of about  $-2\text{ mV}/^{\circ}\text{C}$ . Unfortunately, the absolute value of  $V_{BE}$  varies from device to device, and individual calibration is required to null it, making the technique unsuitable for mass production. The technique used in the ADM1062 is to measure the change in  $V_{BE}$  when the device is operated at two different currents.

The change in  $V_{BE}$  is given by

$$\Delta V_{BE} = kT/q \times \ln(N)$$

where:

$k$  is Boltzmann's constant.

$q$  is the charge on the carrier.

$T$  is the absolute temperature in Kelvin.

$N$  is the ratio of the two currents.

Figure 36 shows the input signal conditioning used to measure the output of a remote temperature sensor. This figure shows the external sensor as a substrate transistor provided for temperature monitoring on some microprocessors, but it could equally be a discrete transistor such as a 2N3904 or 2N3906.

If a discrete transistor is used, the collector is not grounded and should be linked to the base. If a PNP transistor is used, the base is connected to the DN input, and the emitter is connected to the DP input. If an NPN transistor is used, the emitter is connected to the DN input, and the base is connected to the DP input. Figure 34 and Figure 35 show how to connect the ADM1062 to an NPN or PNP transistor for temperature measurement. To prevent ground noise from interfering with the measurement, the more negative terminal of the sensor is not referenced to ground but is biased above ground by an internal diode at the DN input.

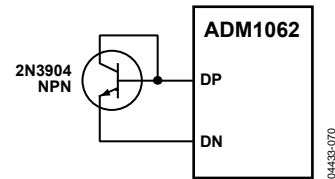

Figure 34. Measuring Temperature Using an NPN Transistor

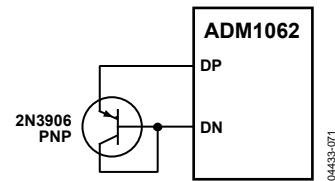

Figure 35. Measuring Temperature Using a PNP Transistor



Figure 36. Signal Conditioning for Remote Diode Temperature Sensors

To measure  $\Delta V_{BE}$ , the sensor is switched between operating currents of I and  $N \times I$ . The resulting waveform is passed through a 65 kHz low-pass filter to remove noise and through a chopper-stabilized amplifier that amplifies and rectifies the waveform to produce a dc voltage proportional to  $\Delta V_{BE}$ . This voltage is measured by the ADC to produce a temperature output in 12-bit offset binary. To further reduce the effects of noise, digital filtering is performed by averaging the results of 16 measurement cycles. A remote temperature measurement takes nominally 600 ms. The results of remote temperature measurements are stored in 12-bit, offset binary format, as shown in Table 11. This format provides temperature readings with a resolution of 0.125°C.

**Table 11. Temperature Data Format**

Temperature	Digital Output (Hex)	Digital Output (Binary)
-128°C	0x400	010000000000
-125°C	0x418	010000011000
-100°C	0x4E0	010011100000
-75°C	0x5A8	010110101000
-50°C	0x670	011001110000
-25°C	0x738	011100111000
-10°C	0x7B0	011110110000
0°C	0x800	100000000000
+10.25°C	0x852	100001010010
+25.5°C	0x8CC	100011001100
+50.75°C	0x996	100110010110
+75°C	0xA58	101001011000
+100°C	0XB20	101100100000
+125°C	0xBE8	101111101000
+128°C	0xC00	110000000000

# APPLICATIONS DIAGRAM

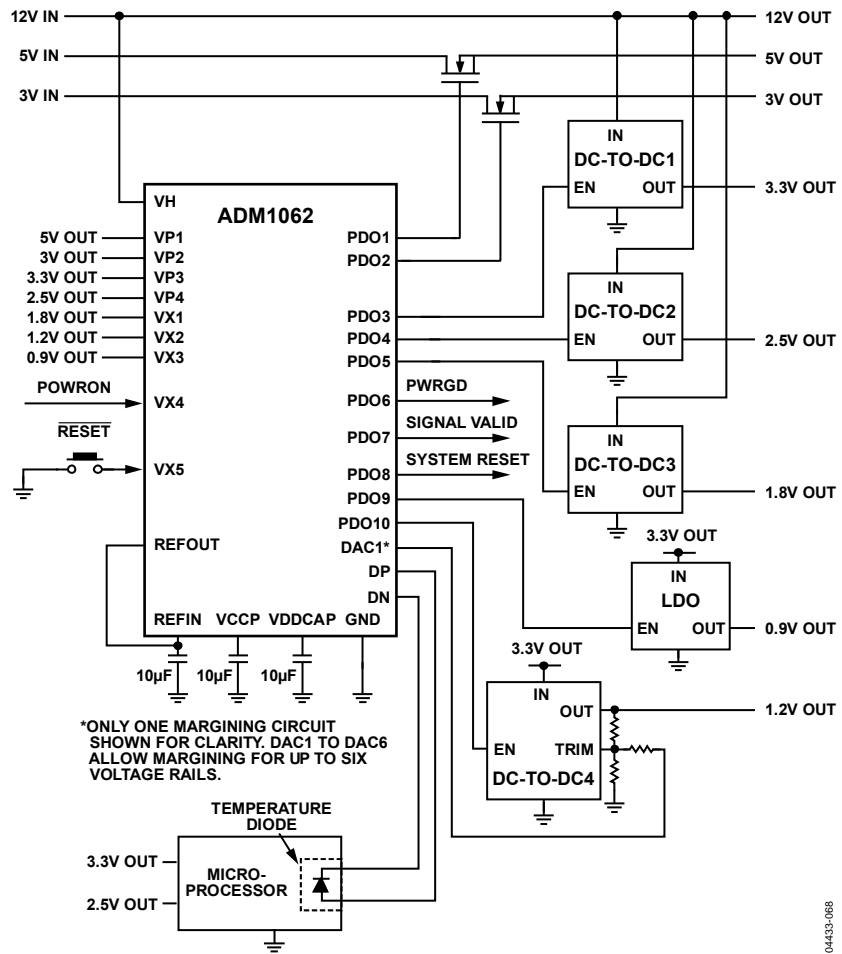

Figure 37. Applications Diagram

04433-06B

## COMMUNICATING WITH THE ADM1062

### CONFIGURATION DOWNLOAD AT POWER-UP

The configuration of the [ADM1062](#) (undervoltage/overvoltage thresholds, glitch filter timeouts, PDO configurations, and so on) is dictated by the contents of the RAM. The RAM comprises digital latches that are local to each of the functions on the device. The latches are double-buffered and have two identical latches, Latch A and Latch B. Therefore, when an update to a function occurs, the contents of Latch A are updated first, and then the contents of Latch B are updated with identical data. The advantages of this architecture are explained in detail in the Updating the Configuration section.

The two latches are volatile memory and lose their contents at power-down. Therefore, the configuration in the RAM must be restored at power-up by downloading the contents of the EEPROM (nonvolatile memory) to the local latches. This download occurs in six steps, as follows:

1. With no power applied to the device, the PDOs are all high impedance.
2. When 1.2 V appears on any of the inputs connected to the  $V_{DD}$  arbitrator (VH or VPx), the PDOs are all weakly pulled to GND with a 20 k $\Omega$  resistor.
3. When the supply rises above the undervoltage lockout of the device (UVLO is 2.5 V), the EEPROM starts to download to the RAM.
4. The EEPROM downloads its contents to all Latch As.
5. When the contents of the EEPROM are completely downloaded to the Latch As, the device controller signals all Latch As to download to all Latch Bs simultaneously, completing the configuration download.
6. At 0.5 ms after the configuration download completes, the first state definition is downloaded from the EEPROM into the SE.

Note that any attempt to communicate with the device prior to the completion of the download causes the [ADM1062](#) to issue a no acknowledge (NACK).

### UPDATING THE CONFIGURATION

After power-up, with all the configuration settings loaded from the EEPROM into the RAM registers, the user may need to alter the configuration of functions on the [ADM1062](#), such as changing the undervoltage or overvoltage limit of an SFD, changing the fault output of an SFD, or adjusting the rise time delay of one of the PDOs.

The [ADM1062](#) provides several options that allow the user to update the configuration over the SMBus interface. The following three options are controlled in the UPDCFG register:

#### Option 1

Update the configuration in real time. The user writes to the RAM across the SMBus, and the configuration is updated immediately.

#### Option 2

Update the Latch As without updating the Latch Bs. With this method, the configuration of the [ADM1062](#) remains unchanged and continues to operate in the original setup until the instruction is given to update the Latch Bs.

#### Option 3

Change the EEPROM register contents without changing the RAM contents, and then download the revised EEPROM contents to the RAM registers. With this method, the configuration of the [ADM1062](#) remains unchanged and continues to operate in the original setup until the instruction is given to update the RAM.

The instruction to download from the EEPROM in Option 3 is also a useful way to restore the original EEPROM contents if revisions to the configuration are unsatisfactory. For example, if the user needs to alter an overvoltage threshold, the RAM register can be updated, as described in Option 1. However, if the user is not satisfied with the change and wants to revert to the original programmed value, the device controller can issue a command to download the EEPROM contents to the RAM again, as described in Option 3, restoring the [ADM1062](#) to its original configuration.

The topology of the [ADM1062](#) makes this type of operation possible. The local, volatile registers (RAM) are all double-buffered latches. Setting Bit 0 of the UPDCFG register to 1 leaves the double-buffered latches open at all times. If Bit 0 is set to 0 when a RAM write occurs across the SMBus, only the first side of the double-buffered latch is written to. The user must then write a 1 to Bit 1 of the UPDCFG register. This generates a pulse to update all the second latches at once. EEPROM writes occur in a similar way.

The final bit in this register can enable or disable EEPROM page erasure. If this bit is set high, the contents of an EEPROM page can all be set to 1. If this bit is set low, the contents of a page cannot be erased, even if the command code for page erasure is programmed across the SMBus. The bit map for the UPDCFG register is shown in the [AN-698 Application Note](#). A flow diagram for download at power-up and subsequent configuration updates is shown in Figure 38.



Figure 38. Configuration Update Flow Diagram

### UPDATING THE SEQUENCING ENGINE

Sequencing engine (SE) functions are not updated in the same way as regular configuration latches. The SE has its own dedicated 512-byte nonvolatile, electrically erasable, programmable, read-only memory (EEPROM) for storing state definitions. The EEPROM provides 63 individual states, each with a 64-bit word (one state is reserved). At power-up, the first state is loaded from the SE EEPROM into the engine itself. When the conditions of this state are met, the next state is loaded from the EEPROM into the engine, and so on. The loading of each new state takes approximately 10 μs.

To alter a state, the required changes must be made directly to the EEPROM. RAM for each state does not exist. The relevant alterations must be made to the 64-bit word, which is then uploaded directly to the EEPROM.

### INTERNAL REGISTERS

The ADM1062 contains a large number of data registers. The principal registers are the address pointer register and the configuration registers.

#### Address Pointer Register

The address pointer register contains the address that selects one of the other internal registers. When writing to the ADM1062, the first byte of data is always a register address that is written to the address pointer register.

#### Configuration Registers

The configuration registers provide control and configuration for various operating parameters of the ADM1062.

### EEPROM

The ADM1062 has two 512-byte cells of nonvolatile EEPROM from Register Address 0xF800 to Register Address 0xFBFF. The EEPROM is used for permanent storage of data that is not lost when the ADM1062 is powered down. One EEPROM cell contains the configuration data of the device; the other contains the state definitions for the SE. Although referred to as read-only memory, the EEPROM can be written to, as well as read from, using the serial bus in exactly the same way as the other registers.

The major differences between the EEPROM and other registers are as follows:

- An EEPROM location must be blank before it can be written to. If it contains data, the data must first be erased.
- Writing to the EEPROM is slower than writing to the RAM.
- Writing to the EEPROM should be restricted because it has a limited write/cycle life of typically 10,000 write operations due to the usual EEPROM wear-out mechanisms.

The first EEPROM is split into 16 (0 to 15) pages of 32 bytes each. Page 0 to Page 6, starting at Address 0xF800, hold the configuration data for the applications on the ADM1062 (such as the SFDs and PDOs). These EEPROM addresses are the same as the RAM register addresses, prefixed by F8. Page 7 is reserved. Page 8 to Page 15 are for customer use.

Data can be downloaded from the EEPROM to the RAM in one of the following ways:

- At power-up, when Page 0 to Page 6 are downloaded
- By setting Bit 0 of the UDOWNLD register (0xD8), which performs a user download of Page 0 to Page 6

### SERIAL BUS INTERFACE

The ADM1062 is controlled via the serial system management bus (SMBus) and is connected to this bus as a slave device under the control of a master device. It takes approximately 1 ms after power-up for the ADM1062 to download from its EEPROM. Therefore, access to the ADM1062 is restricted until the download is complete.

#### Identifying the ADM1062 on the SMBus

The ADM1062 has a 7-bit serial bus slave address (see Table 12). The device is powered up with a default serial bus address. The five MSBs of the address are set to 00101; the two LSBs are determined by the logical states of Pin A1 and Pin A0. This allows the connection of four ADM1062 devices to one SMBus.

Table 12. Serial Bus Slave Address

A1 Pin	A0 Pin	Hex Address	7-Bit Address <sup>1</sup>
Low	Low	0x28	0010100x
Low	High	0x2A	0010101x
High	Low	0x2C	0010110x
High	High	0x2E	0010111x

<sup>1</sup>x = Read/Write bit. The address is shown only as the first 7 MSBs.

The device also has several identification registers (read-only) that can be read across the SMBus. Table 13 lists these registers with their values and functions.

**Table 13. Identification Register Values and Functions**

Name	Address	Value	Function
MANID	0xF4	0x41	Manufacturer ID for Analog Devices
REVID	0xF5	0x02	Silicon revision
MARK1	0xF6	0x00	Software brand
MARK2	0xF7	0x00	Software brand

### General SMBus Timing

Figure 39, Figure 40, and Figure 41 are timing diagrams for general read and write operations using the SMBus. The SMBus specification defines specific conditions for different types of read and write operations, which are discussed in the Write Operations and Read Operations sections.

The general SMBus protocol operates as follows:

#### Step 1

The master initiates data transfer by establishing a start condition, defined as a high-to-low transition on the serial data (SDA) line, while the serial clock-line (SCL) remains high. This indicates that a data stream follows. All slave peripherals connected to the serial bus respond to the start condition and shift in the next eight bits, consisting of a 7-bit slave address (MSB first) plus an  $\overline{R/W}$  bit. This bit determines the direction of the data transfer, that is, whether data is written to or read from the slave device (0 = write, 1 = read).

The peripheral whose address corresponds to the transmitted address responds by pulling the data line low during the low period before the ninth clock pulse, known as the acknowledge bit, and by holding it low during the high period of this clock pulse.

All other devices on the bus remain idle while the selected device waits for data to be read from or written to it. If the  $\overline{R/W}$  bit is a 0, the master writes to the slave device. If the  $\overline{R/W}$  bit is a 1, the master reads from the slave device.

#### Step 2

Data is sent over the serial bus in sequences of nine clock pulses: eight bits of data followed by an acknowledge bit from the slave device. Data transitions on the data line must occur during the low period of the clock signal and remain stable during the high period because a low-to-high transition when the clock is high could be interpreted as a stop signal. If the operation is a write operation, the first data byte after the slave address is a command byte. This command byte tells the slave device what to expect next.

It may be an instruction telling the slave device to expect a block write, or it may be a register address that tells the slave where subsequent data is to be written. Because data can flow in only one direction, as defined by the  $\overline{R/W}$  bit, sending a command to a slave device during a read operation is not possible. Before a read operation, it may be necessary to perform a write operation to tell the slave what sort of read operation to expect and/or the address from which data is to be read.

#### Step 3

When all data bytes have been read or written, stop conditions are established. In write mode, the master pulls the data line high during the 10th clock pulse to assert a stop condition. In read mode, the master device releases the SDA line during the low period before the ninth clock pulse, but the slave device does not pull it low. This is known as a no acknowledge. The master then takes the data line low during the low period before the 10th clock pulse and then high during the 10th clock pulse to assert a stop condition.

#### SCL Held Low Timeout

If the bus master holds the SCL low for a time that is a multiple of approximately 30 ms, the ADM1062 bus interface may timeout. If this timeout happens, the in progress transaction is NACKed, and the transaction must be repeated. This behavior is only seen if the I<sup>2</sup>C bus master is interrupted midtransaction by a higher priority task that delays completion of the transaction.

#### False Start Detection

The data hold time specification defines the time that data must be valid on the SDA line, following an SCL falling edge. If there are multiple ADM1062 devices on the same bus, one of the ADM1062 devices may see the SCL/SDA transition due to an acknowledge (ACK) from a different device as a start condition because of internal timing skew, which for most transactions, this is not an issue. In a case where the data appearing on the bus after the false start is detected happens to match the address of another ADM1062 on the bus, that device may incorrectly ACK.

A bus master may see this ACK as another bus master talking on the bus, halt the bus transaction, and not produce any more clocks on the SCL. As a result, the ADM1062 device that incorrectly ACKed continues to hold down the SDA line low. To retry the halted bus transaction, the bus master performs a clock flush on the SCL by sending a series of up to 16 clock pulses. The clock flush forces the ADM1062 to release the SDA line.



Figure 39. General SMBus Write Timing Diagram



Figure 40. General SMBus Read Timing Diagram



Figure 41. Serial Bus Timing Diagram

**SMBus PROTOCOLS FOR RAM AND EEPROM**

The ADM1062 contains volatile registers (RAM) and non-volatile registers (EEPROM). User RAM occupies Address 0x00 to Address 0xDF; the EEPROM occupies Address 0xF800 to Address 0xFBFF.

Data can be written to and read from both the RAM and the EEPROM as single data bytes. Data can be written only to unprogrammed EEPROM locations. To write new data to a programmed location, the location contents must first be erased. EEPROM erasure cannot be done at the byte level. The EEPROM is arranged as 32 pages of 32 bytes each, and an entire page must be erased.

Page erasure is enabled by setting Bit 2 in the UPDCFG register (Address 0x90) to 1. If this bit is not set, page erasure cannot occur, even if the command byte (0xFE) is programmed across the SMBus.

**WRITE OPERATIONS**

The SMBus specification defines several protocols for different types of read and write operations. The following abbreviations are used in Figure 42 to Figure 50:

- S = Start
- P = Stop
- R = Read
- W = Write
- A = Acknowledge
- $\bar{A}$  = No acknowledge

The ADM1062 uses the following SMBus write protocols.

**Send Byte**

In a send byte operation, the master device sends a single command byte to a slave device, as follows:

1. The master device asserts a start condition on SDA.
2. The master sends the 7-bit slave address followed by the write bit (low).
3. The addressed slave device asserts an acknowledge (ACK) on SDA.
4. The master sends a command code.
5. The slave asserts an ACK on SDA.
6. The master asserts a stop condition on SDA, and the transaction ends.

In the ADM1062, the send byte protocol is used for two purposes:

- To write a register address to the RAM for a subsequent single byte read from the same address, or for a block read or a block write starting at that address, as shown in Figure 42.



Figure 42. Setting a RAM Address for Subsequent Read

- To erase a page of EEPROM memory. EEPROM memory can be written to only if it is unprogrammed. Before writing to one or more EEPROM memory locations that are already programmed, the page(s) containing those locations must first be erased. EEPROM memory is erased by writing a command byte.

The master sends a command code telling the slave device to erase the page. The ADM1062 command code for a page erasure is 0xFE (1111 1110). Note that for a page erasure to take place, the page address must be given in the previous write word transaction (see the Write Byte/Word section). In addition, Bit 2 in the UPDCFG register (Address 0x90) must be set to 1.



Figure 43. EEPROM Page Erasure

As soon as the ADM1062 receives the command byte, page erasure begins. The master device can send a stop command as soon as it sends the command byte. Page erasure takes approximately 20 ms. If the ADM1062 is accessed before erasure is complete, it responds with a no acknowledge (NACK).



**Write Byte/Word**

In a write byte/word operation, the master device sends a command byte and one or two data bytes to the slave device, as follows:

1. The master device asserts a start condition on SDA.
2. The master sends the 7-bit slave address followed by the write bit (low).
3. The addressed slave device asserts an ACK on SDA.
4. The master sends a command code.
5. The slave asserts an ACK on SDA.
6. The master sends a data byte.
7. The slave asserts an ACK on SDA.
8. The master sends a data byte or asserts a stop condition.
9. The slave asserts an ACK on SDA.
10. The master asserts a stop condition on SDA to end the transaction.

In the [ADM1062](#), the write byte/word protocol is used for three purposes:

- To write a single byte of data to the RAM. In this case, the command byte is RAM Address 0x00 to RAM Address 0xDF, and the only data byte is the actual data, as shown in Figure 44.

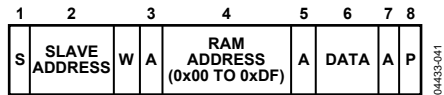

Figure 44. Single Byte Write to the RAM

- To set up a 2-byte EEPROM address for a subsequent read, write, block read, block write, or page erase. In this case, the command byte is the high byte of EEPROM Address 0xF8 to EEPROM Address 0xFB. The only data byte is the low byte of the EEPROM address, as shown in Figure 45.

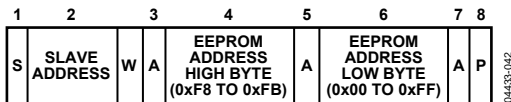

Figure 45. Setting an EEPROM Address

Because a page consists of 32 bytes, only the three MSBs of the address low byte are important for page erasure. The lower five bits of the EEPROM address low byte specify the addresses within a page and are ignored during an erase operation.

- To write a single byte of data to the EEPROM. In this case, the command byte is the high byte of EEPROM Address 0xF8 to EEPROM Address 0xFB. The first data byte is the low byte of the EEPROM address, and the second data byte is the actual data, as shown in Figure 46.

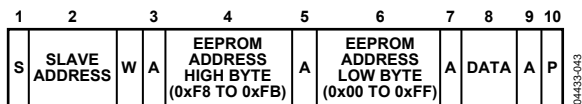

Figure 46. Single Byte Write to the EEPROM

**Block Write**

In a block write operation, the master device writes a block of data to a slave device. The start address for a block write must have been set previously. In the [ADM1062](#), a send byte operation sets a RAM address, and a write byte/word operation sets an EEPROM address, as follows:

1. The master device asserts a start condition on SDA.
2. The master sends the 7-bit slave address followed by the write bit (low).
3. The addressed slave device asserts an ACK on SDA.
4. The master sends a command code that tells the slave device to expect a block write. The [ADM1062](#) command code for a block write is 0xFC (1111 1100).
5. The slave asserts an ACK on SDA.
6. The master sends a data byte that tells the slave device how many data bytes are being sent. The SMBus specification allows a maximum of 32 data bytes in a block write.
7. The slave asserts an ACK on SDA.
8. The master sends N data bytes.
9. The slave asserts an ACK on SDA after each data byte.
10. The master asserts a stop condition on SDA to end the transaction.



Figure 47. Block Write to the EEPROM or RAM

Unlike some EEPROM devices that limit block writes to within a page boundary, there is no limitation on the start address when performing a block write to EEPROM, except when

- There must be at least N locations from the start address to the highest EEPROM address (0xFBFF) to avoid writing to invalid addresses.
- An address crosses a page boundary. In this case, both pages must be erased before programming.

Note that the [ADM1062](#) features a clock extend function for writes to EEPROM. Programming an EEPROM byte takes approximately 250 μs, which limits the SMBus clock for repeated or block write operations. The [ADM1062](#) pulls SCL low and extends the clock pulse when it cannot accept any more data.

## READ OPERATIONS

The ADM1062 uses the following SMBus read protocols.

### Receive Byte

In a receive byte operation, the master device receives a single byte from a slave device, as follows:

1. The master device asserts a start condition on SDA.
2. The master sends the 7-bit slave address followed by the read bit (high).
3. The addressed slave device asserts an ACK on SDA.
4. The master receives a data byte.
5. The master asserts a NACK on SDA.
6. The master asserts a stop condition on SDA, and the transaction ends.

In the ADM1062, the receive byte protocol is used to read a single byte of data from a RAM or EEPROM location whose address has previously been set by a send byte or write byte/word operation, as shown in Figure 48.



Figure 48. Single Byte Read from the EEPROM or RAM

In a block read operation, the master device reads a block of data from a slave device. The start address for a block read must have been set previously. In the ADM1062, this is done by a send byte operation to set a RAM address, or a write byte/word operation to set an EEPROM address. The block read operation itself consists of a send byte operation that sends a block read command to the slave, immediately followed by a repeated start and a read operation that reads out multiple data bytes, as follows:

1. The master device asserts a start condition on SDA.
2. The master sends the 7-bit slave address followed by the write bit (low).
3. The addressed slave device asserts an ACK on SDA.
4. The master sends a command code that tells the slave device to expect a block read. The ADM1062 command code for a block read is 0xFD (1111 1101).
5. The slave asserts an ACK on SDA.
6. The master asserts a repeat start condition on SDA.
7. The master sends the 7-bit slave address followed by the read bit (high).
8. The slave asserts an ACK on SDA.
9. The ADM1062 sends a byte-count data byte that tells the master how many data bytes to expect. The ADM1062 always returns 32 data bytes (0x20), which is the maximum allowed by the SMBus Version 1.1 specification.

10. The master asserts an ACK on SDA.
11. The master receives 32 data bytes.
12. The master asserts an ACK on SDA after each data byte.
13. The master asserts a stop condition on SDA to end the transaction.

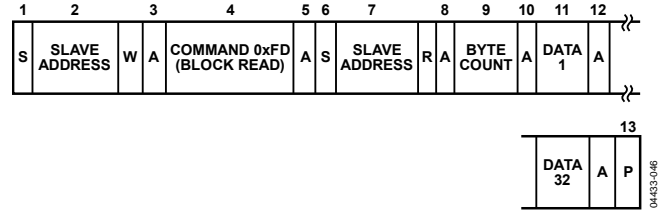

Figure 49. Block Read from the EEPROM or RAM

### Error Correction

The ADM1062 provides the option of issuing a packet error correction (PEC) byte after a write to the RAM, a write to the EEPROM, a block write to the RAM/EEPROM, or a block read from the RAM/ EEPROM. This option enables the user to verify that the data received by or sent from the ADM1062 is correct. The PEC byte is an optional byte sent after the last data byte has been written to or read from the ADM1062. The protocol is the same as a block read for Step 1 to Step 12 and then proceeds as follows:

13. The ADM1062 issues a PEC byte to the master. The master checks the PEC byte and issues another block read if the PEC byte is incorrect.
14. A NACK is generated after the PEC byte to signal the end of the read.
15. The master asserts a stop condition on SDA to end the transaction.

Note that the PEC byte is calculated using CRC-8. The frame check sequence (FCS) conforms to CRC-8 by the polynomial

$$C(x) = x^8 + x^2 + x^1 + 1$$

See the SMBus Version 1.1 specification for details.

An example of a block read with the optional PEC byte is shown in Figure 50.



Figure 50. Block Read from the EEPROM or RAM with PEC

OUTLINE DIMENSIONS



COMPLIANT TO JEDEC STANDARDS MO-220-WJJD.

Figure 51. 40-Lead Lead Frame Chip Scale Package [LFCSP\_WQ]  
6 mm x 6 mm Body, Very Very Thin Quad  
(CP-40-9)

Dimensions shown in millimeters

05-06-2011-A

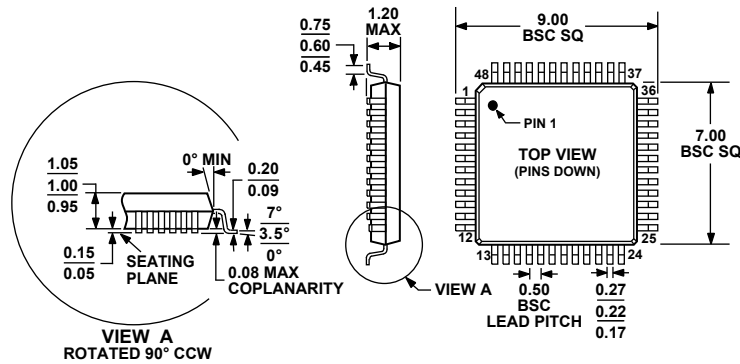

COMPLIANT TO JEDEC STANDARDS MS-026ABC

Figure 52. 48-Lead Thin Plastic Quad Flat Package [TQFP]  
(SU-48)

Dimensions shown in millimeters

ORDERING GUIDE

Model <sup>1</sup>	Temperature Range	Package Description	Package Option
ADM1062ACPZ	-40°C to +85°C	40-Lead Lead Frame Chip Scale Package [LFCSP_WQ]	CP-40-9
ADM1062ACPZ-REEL7	-40°C to +85°C	40-Lead Lead Frame Chip Scale Package [LFCSP_WQ]	CP-40-9
ADM1062ASUZ	-40°C to +85°C	48-Lead Thin Plastic Quad Flat Package [TQFP]	SU-48
ADM1062ASUZ-REEL7	-40°C to +85°C	48-Lead Thin Plastic Quad Flat Package [TQFP]	SU-48
EVAL-ADM1062TQEBZ		Evaluation Kit (TQFP Version)	

<sup>1</sup> Z = RoHS Compliant Part.

<sup>1</sup>2C refers to a communications protocol originally developed by Philips Semiconductors (now NXP Semiconductors).

Компания «Океан Электроники» предлагает заключение долгосрочных отношений при поставках импортных электронных компонентов на взаимовыгодных условиях!

Наши преимущества:

- Поставка оригинальных импортных электронных компонентов напрямую с производств Америки, Европы и Азии, а так же с крупнейших складов мира;
- Широкая линейка поставок активных и пассивных импортных электронных компонентов (более 30 млн. наименований);
- Поставка сложных, дефицитных, либо снятых с производства позиций;
- Оперативные сроки поставки под заказ (от 5 рабочих дней);
- Экспресс доставка в любую точку России;
- Помощь Конструкторского Отдела и консультации квалифицированных инженеров;
- Техническая поддержка проекта, помощь в подборе аналогов, поставка прототипов;
- Поставка электронных компонентов под контролем ВП;
- Система менеджмента качества сертифицирована по Международному стандарту ISO 9001;
- При необходимости вся продукция военного и аэрокосмического назначения проходит испытания и сертификацию в лаборатории (по согласованию с заказчиком);
- Поставка специализированных компонентов военного и аэрокосмического уровня качества (Xilinx, Altera, Analog Devices, Intersil, Interpoint, Microsemi, Actel, Aeroflex, Peregrine, VPT, Syfer, Eurofarad, Texas Instruments, MS Kennedy, Miteq, Cobham, E2V, MA-COM, Hittite, Mini-Circuits, General Dynamics и др.);

Компания «Океан Электроники» является официальным дистрибьютором и эксклюзивным представителем в России одного из крупнейших производителей разъемов военного и аэрокосмического назначения «JONHON», а так же официальным дистрибьютором и эксклюзивным представителем в России производителя высокотехнологичных и надежных решений для передачи СВЧ сигналов «FORSTAR».



## JONHON

«JONHON» (основан в 1970 г.)

Разъемы специального, военного и аэрокосмического назначения:

(Применяются в военной, авиационной, аэрокосмической, морской, железнодорожной, горно- и нефтедобывающей отраслях промышленности)

«FORSTAR» (основан в 1998 г.)

ВЧ соединители, коаксиальные кабели, кабельные сборки и микроволновые компоненты:

(Применяются в телекоммуникациях гражданского и специального назначения, в средствах связи, РЛС, а так же военной, авиационной и аэрокосмической отраслях промышленности).



Телефон: 8 (812) 309-75-97 (многоканальный)

Факс: 8 (812) 320-03-32

Электронная почта: [ocean@oceanchips.ru](mailto:ocean@oceanchips.ru)

Web: <http://oceanchips.ru/>

Адрес: 198099, г. Санкт-Петербург, ул. Калинина, д. 2, корп. 4, лит. А