

## 1 Form A Solid-State Relay

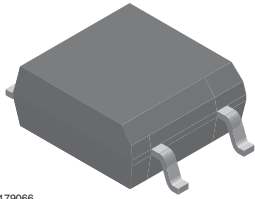

i179066

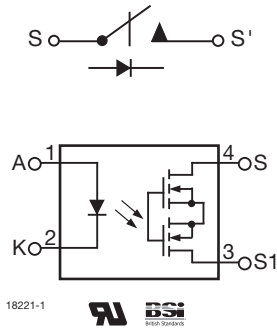

18221-1



### DESCRIPTION

The LH1546AEF (4 pin SOP) is robust, ideal for telecom and ground fault applications. It is an SPST normally open switch (1 form A) that replaces electromechanical relays in many applications. It is constructed using a GaAs LED for actuation control and an integrated monolithic die for the switch output. The die, fabricated in a high-voltage dielectrically isolated BCDMOS technology, is comprised of a photodiode array, switch control circuitry and MOSFET switches. In addition, it employs current-limiting circuitry which meets lightning surge testing as per ANSI/TIA-968-B and other regulatory voltage surge requirements when overvoltage protection is provided.

### FEATURES

- Current limit protection
- Isolation test voltage 3000 V<sub>RMS</sub>
- Typical R<sub>ON</sub> 28 Ω
- Load voltage 350 V
- Load current 120 mA
- High surge capability
- Clean bounce free switching
- Low power consumption
- High reliability monolithic receptor
- SMD lead available on tape and reel
- Equivalent to CPC1035N
- Compliant to RoHS Directive 2002/95/EC and in accordance to WEEE 2002/96/EC



RoHS  
COMPLIANT

### APPLICATIONS

- General telecom switching
  - On/off hook control
  - Ring relay
  - Dial pulse
  - Ground start
  - Ground fault protection
- Instrumentation
- Industrial controls

### Note

- See "solid-state relays" (application note 56)

### AGENCY APPROVALS

UL1577: file no. E52744 system code O

BSI/BABT: certification no. 8500 issue 2

ORDERING INFORMATION											
L	H	1	5	4	6	A	#	#	T	#	
PART NUMBER						ELECTR. VARIATION	PACKAGE CONFIG.		TAPE AND REEL		
PACKAGE						UL, BSI					
SOP-4, tape and reel (product rotated in tape)						LH1546AEFT2					
SOP-4, tape and reel						LH1546AEFTR					
SOP-4, tubes						LH1546AEF					



ABSOLUTE MAXIMUM RATINGS ( $T_{amb} = 25\text{ }^{\circ}\text{C}$ , unless otherwise specified)				
PARAMETER	TEST CONDITION	SYMBOL	VALUE	UNIT
<b>INPUT</b>				
LED continuous forward current		$I_F$	50	mA
LED reverse voltage	$I_R \leq 10\text{ }\mu\text{A}$	$V_R$	6	V
<b>OUTPUT</b>				
DC or peak AC load voltage	$I_L \leq 50\text{ }\mu\text{A}$	$V_L$	350	V
Continuous DC load current at 25 °C, bidirectional		$I_L$	120	mA
<b>SSR</b>				
SSR output power dissipation (continuous)		$P_{diss}$	550	mW
Ambient temperature range		$T_{amb}$	- 40 to + 85	$^{\circ}\text{C}$
Storage temperature range		$T_{stg}$	- 40 to + 150	$^{\circ}\text{C}$
Soldering temperature <sup>(1)</sup>	$t = 10\text{ s max.}$	$T_{sld}$	260	$^{\circ}\text{C}$
Isolation test voltage	$t = 1\text{ s}$	$V_{ISO}$	3000	$V_{RMS}$
Isolation resistance	$V_{IO} = 500\text{ V}, T_{amb} = 25\text{ }^{\circ}\text{C}$	$R_{IO}$	$\geq 10^{12}$	$\Omega$
	$V_{IO} = 500\text{ V}, T_{amb} = 100\text{ }^{\circ}\text{C}$	$R_{IO}$	$\geq 10^{11}$	$\Omega$

**Notes**

- Stresses in excess of the absolute maximum ratings can cause permanent damage to the device. Functional operation of the device is not implied at these or any other conditions in excess of those given in the operational sections of this document. Exposure to absolute maximum ratings for extended periods of the time can adversely affect reliability.

(1) Refer to reflow profile for soldering conditions for surface mounted devices.

ELECTRICAL CHARACTERISTICS ( $T_{amb} = 25\text{ }^{\circ}\text{C}$ , unless otherwise specified)						
PARAMETER	TEST CONDITION	SYMBOL	MIN.	TYP.	MAX.	UNIT
<b>INPUT</b>						
LED forward current, switch turn-on	$I_L = 100\text{ mA}, t = 10\text{ ms}$	$I_{Fon}$		1.1	2	mA
LED forward current, switch turn-off	$V_L = \pm 300\text{ V}$	$I_{Foff}$	0.2	0.6		mA
LED forward voltage	$I_F = 10\text{ mA}$	$V_F$	1	1.18	1.45	V
<b>OUTPUT</b>						
On-resistance, AC/DC: pin 3 ( $\pm$ ) to 4 ( $\pm$ )	$I_F = 5\text{ mA}, I_L = 50\text{ mA}$	$R_{ON}$		28	35	$\Omega$
Off-resistance	$I_F = 0\text{ mA}, V_L = \pm 100\text{ V}$	$R_{OFF}$	0.5	5000		$\text{G}\Omega$
Off-state leakage current	$I_F = 0\text{ mA}, V_L = \pm 100\text{ V}$	$I_O$		0.32	200	nA
	$I_F = 0\text{ mA}, V_L = \pm 350\text{ V}$	$I_O$			1	nA
Output capacitance pin 3 to 4	$I_F = 0\text{ mA}, V_L = 1\text{ V}$	$C_O$		55		pF
	$I_F = 0\text{ mA}, V_L = 50\text{ V}$	$C_O$		10		pF
Current limit	$I_F = 5\text{ mA}, t = 5\text{ ms}, V_L = \pm 6\text{ V}$	$I_{limit}$	170	210	250	mA
<b>TRANSFER</b>						
Capacitance (input to output)	$V_{ISO} = 1\text{ V}$	$C_{IO}$		0.6		pF

**Note**

- Minimum and maximum values are testing requirements. Typical values are characteristics of the device and are the result of engineering evaluations. Typical values are for information only and are not part of the testing requirements.

SWITCHING CHARACTERISTICS ( $T_{amb} = 25\text{ }^{\circ}\text{C}$ , unless otherwise specified)						
PARAMETER	TEST CONDITION	SYMBOL	MIN.	TYP.	MAX.	UNIT
Turn-on time	$I_F = 5\text{ mA}, I_L = 50\text{ mA}$	$t_{on}$		2	3	ms
Turn-off time	$I_F = 5\text{ mA}, I_L = 50\text{ mA}$	$t_{off}$		0.08	3	ms



## TYPICAL CHARACTERISTICS ( $T_{amb} = 25\text{ }^{\circ}\text{C}$ , unless otherwise specified)

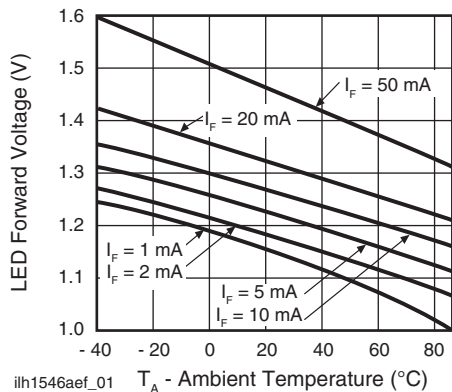

Fig. 1 - LED Voltage vs. Temperature

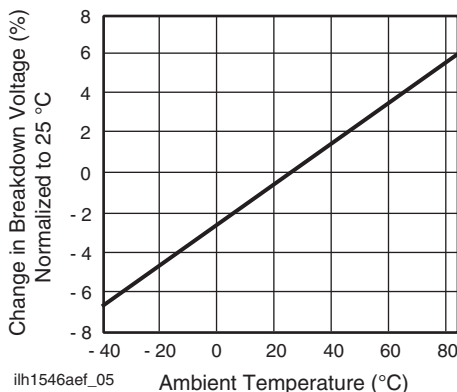

Fig. 4 - Switch Breakdown Voltage vs. Temperature

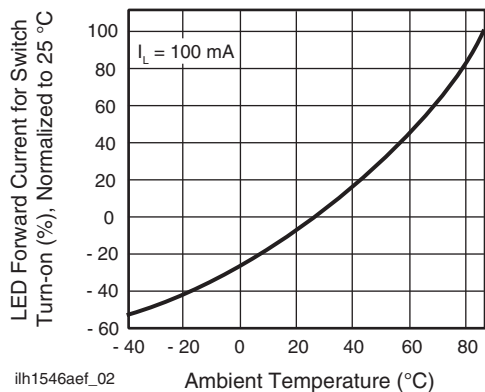

Fig. 2 - LED Current for Switch Turn-on vs. Temperature

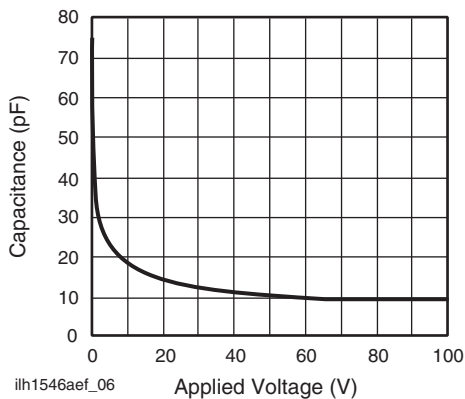

Fig. 5 - Switch Capacitance vs. Applied Voltage

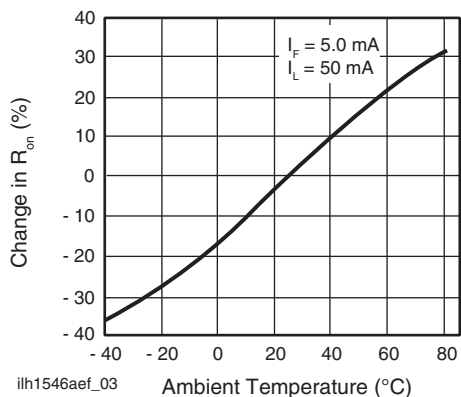

Fig. 3 - On-Resistance vs. Temperature

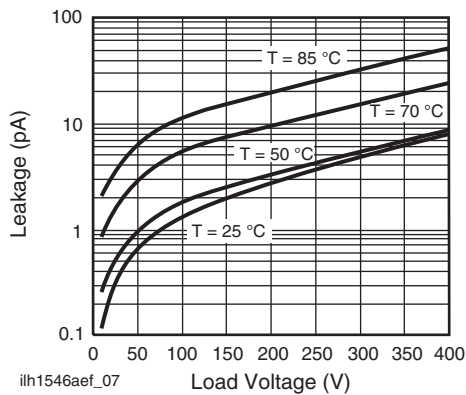

Fig. 6 - Leakage Current vs. Applied Voltage

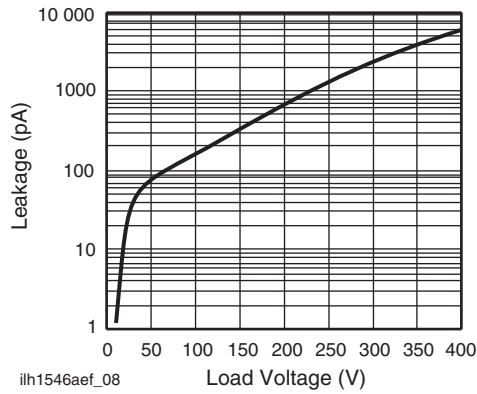

Fig. 7 - Leakage Current vs. Applied Voltage

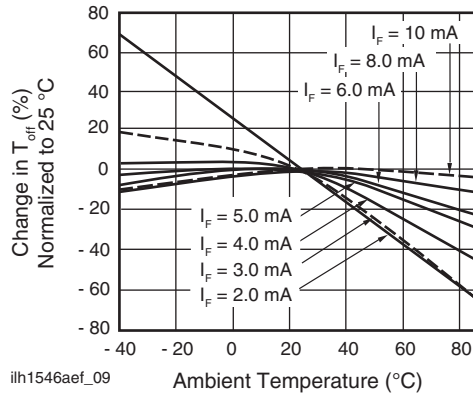

Fig. 8 - Turn-off Time vs. Temperature

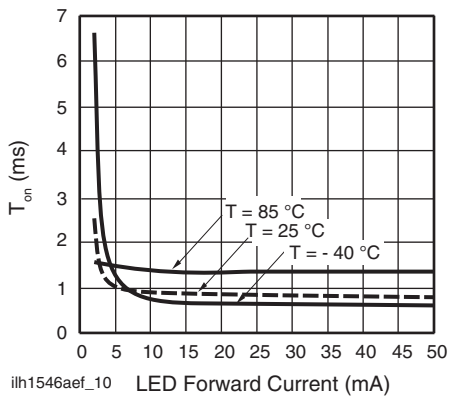
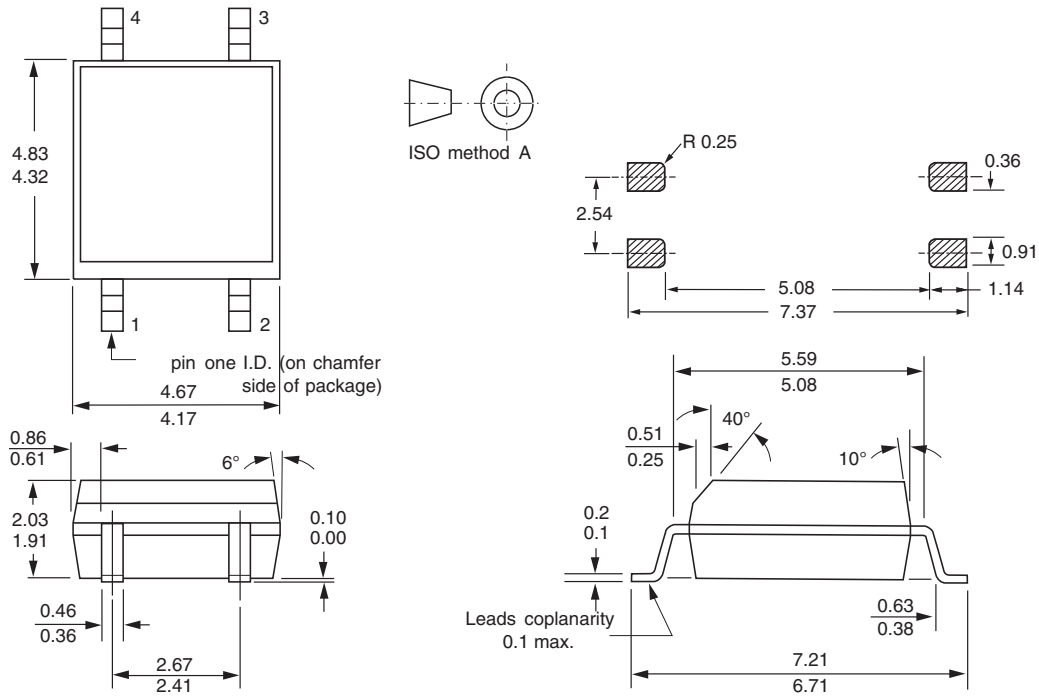

Fig. 9 - Turn-on Time vs. LED Current



## PACKAGE DIMENSIONS in millimeters



i178030

## PACKAGE MARKING (example)

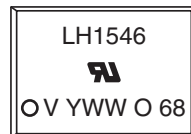

### Note

- Tape and reel suffix (TR) is not part of the package marking.



## Disclaimer

ALL PRODUCT, PRODUCT SPECIFICATIONS AND DATA ARE SUBJECT TO CHANGE WITHOUT NOTICE TO IMPROVE RELIABILITY, FUNCTION OR DESIGN OR OTHERWISE.

Vishay Intertechnology, Inc., its affiliates, agents, and employees, and all persons acting on its or their behalf (collectively, "Vishay"), disclaim any and all liability for any errors, inaccuracies or incompleteness contained in any datasheet or in any other disclosure relating to any product.

Vishay makes no warranty, representation or guarantee regarding the suitability of the products for any particular purpose or the continuing production of any product. To the maximum extent permitted by applicable law, Vishay disclaims (i) any and all liability arising out of the application or use of any product, (ii) any and all liability, including without limitation special, consequential or incidental damages, and (iii) any and all implied warranties, including warranties of fitness for particular purpose, non-infringement and merchantability.

Statements regarding the suitability of products for certain types of applications are based on Vishay's knowledge of typical requirements that are often placed on Vishay products in generic applications. Such statements are not binding statements about the suitability of products for a particular application. It is the customer's responsibility to validate that a particular product with the properties described in the product specification is suitable for use in a particular application. Parameters provided in datasheets and/or specifications may vary in different applications and performance may vary over time. All operating parameters, including typical parameters, must be validated for each customer application by the customer's technical experts. Product specifications do not expand or otherwise modify Vishay's terms and conditions of purchase, including but not limited to the warranty expressed therein.

Except as expressly indicated in writing, Vishay products are not designed for use in medical, life-saving, or life-sustaining applications or for any other application in which the failure of the Vishay product could result in personal injury or death. Customers using or selling Vishay products not expressly indicated for use in such applications do so at their own risk and agree to fully indemnify and hold Vishay and its distributors harmless from and against any and all claims, liabilities, expenses and damages arising or resulting in connection with such use or sale, including attorneys fees, even if such claim alleges that Vishay or its distributor was negligent regarding the design or manufacture of the part. Please contact authorized Vishay personnel to obtain written terms and conditions regarding products designed for such applications.

No license, express or implied, by estoppel or otherwise, to any intellectual property rights is granted by this document or by any conduct of Vishay. Product names and markings noted herein may be trademarks of their respective owners.

Компания «Океан Электроники» предлагает заключение долгосрочных отношений при поставках импортных электронных компонентов на взаимовыгодных условиях!

Наши преимущества:

- Поставка оригинальных импортных электронных компонентов напрямую с производств Америки, Европы и Азии, а так же с крупнейших складов мира;
- Широкая линейка поставок активных и пассивных импортных электронных компонентов (более 30 млн. наименований);
- Поставка сложных, дефицитных, либо снятых с производства позиций;
- Оперативные сроки поставки под заказ (от 5 рабочих дней);
- Экспресс доставка в любую точку России;
- Помощь Конструкторского Отдела и консультации квалифицированных инженеров;
- Техническая поддержка проекта, помощь в подборе аналогов, поставка прототипов;
- Поставка электронных компонентов под контролем ВП;
- Система менеджмента качества сертифицирована по Международному стандарту ISO 9001;
- При необходимости вся продукция военного и аэрокосмического назначения проходит испытания и сертификацию в лаборатории (по согласованию с заказчиком);
- Поставка специализированных компонентов военного и аэрокосмического уровня качества (Xilinx, Altera, Analog Devices, Intersil, Interpoint, Microsemi, Actel, Aeroflex, Peregrine, VPT, Syfer, Eurofarad, Texas Instruments, MS Kennedy, Miteq, Cobham, E2V, MA-COM, Hittite, Mini-Circuits, General Dynamics и др.);

Компания «Океан Электроники» является официальным дистрибьютором и эксклюзивным представителем в России одного из крупнейших производителей разъемов военного и аэрокосмического назначения «JONHON», а так же официальным дистрибьютором и эксклюзивным представителем в России производителя высокотехнологичных и надежных решений для передачи СВЧ сигналов «FORSTAR».



## JONHON

«JONHON» (основан в 1970 г.)

Разъемы специального, военного и аэрокосмического назначения:

(Применяются в военной, авиационной, аэрокосмической, морской, железнодорожной, горно- и нефтедобывающей отраслях промышленности)

«FORSTAR» (основан в 1998 г.)

ВЧ соединители, коаксиальные кабели,  
кабельные сборки и микроволновые компоненты:

(Применяются в телекоммуникациях гражданского и специального назначения, в средствах связи, РЛС, а так же военной, авиационной и аэрокосмической отраслях промышленности).



Телефон: 8 (812) 309-75-97 (многоканальный)

Факс: 8 (812) 320-03-32

Электронная почта: [ocean@oceanchips.ru](mailto:ocean@oceanchips.ru)

Web: <http://oceanchips.ru/>

Адрес: 198099, г. Санкт-Петербург, ул. Калинина, д. 2, корп. 4, лит. А