

**ISOTOP<sup>®</sup> Boost chopper  
Trench + Field Stop IGBT<sup>®</sup>**

**$V_{CES} = 1200V$   
 $I_C = 75A @ T_c = 80^{\circ}C$**

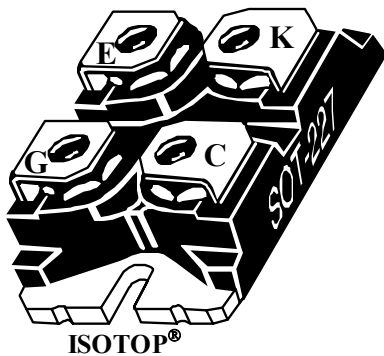
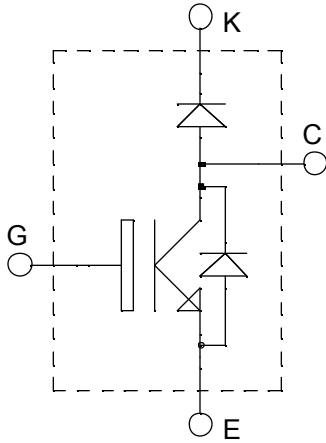

#### Application

- AC and DC motor control
- Switched Mode Power Supplies
- Power Factor Correction
- Brake switch

#### Features

- Trench + Field Stop IGBT<sup>®</sup> Technology
  - Low voltage drop
  - Low tail current
  - Switching frequency up to 20 kHz
  - Soft recovery parallel diodes
  - Low diode VF
  - Low leakage current
  - Avalanche energy rated
  - RBSOA and SCSOA rated
- ISOTOP<sup>®</sup> Package (SOT-227)
- Very low stray inductance
- High level of integration

#### Benefits

- Low conduction losses
- Stable temperature behavior
- Very rugged
- Direct mounting to heatsink (isolated package)
- Low junction to case thermal resistance
- Easy paralleling due to positive  $T_C$  of  $V_{CESat}$
- RoHS Compliant

#### Absolute maximum ratings

| Symbol     | Parameter                                   |                     | Max ratings | Unit |
|------------|---|---------------------|-------------|------|
| $V_{CES}$  | Collector - Emitter Breakdown Voltage       |                     | 1200        | V    |
| $I_{C1}$   | Continuous Collector Current                | $T_C = 25^{\circ}C$ | 100         | A    |
| $I_{C2}$   |   | $T_C = 80^{\circ}C$ | 75          |      |
| $I_{CM}$   | Pulsed Collector Current                    | $T_C = 25^{\circ}C$ | 175         |      |
| $V_{GE}$   | Gate - Emitter Voltage                      |                     | $\pm 20$    | V    |
| $P_D$      | Maximum Power Dissipation                   | $T_C = 25^{\circ}C$ | 416         | W    |
| $I_{FAV}$  | Maximum Average Forward Current             | Duty cycle=0.5      | 27          | A    |
| $I_{FRMS}$ | RMS Forward Current (Square wave, 50% duty) | $T_C = 80^{\circ}C$ |             |      |

**CAUTION:** These Devices are sensitive to Electrostatic Discharge. Proper Handling Procedures Should Be Followed.

All ratings @  $T_j = 25^\circ\text{C}$  unless otherwise specified

**Electrical Characteristics**

| <i>Symbol</i> | <i>Characteristic</i>               | <i>Test Conditions</i>                        | <i>Min</i>                       | <i>Typ</i> | <i>Max</i> | <i>Unit</i> |
|---------------|-------------------------------------|---|----------------------------------|------------|------------|-------------|
| $I_{CES}$     | Zero Gate Voltage Collector Current | $V_{GE} = 0\text{V}, V_{CE} = 1200\text{V}$   |                                  |            | 5          | mA          |
| $V_{CE(on)}$  | Collector Emitter on Voltage        | $V_{GE} = 15\text{V}$<br>$I_C = 75\text{A}$   | $T_j = 25^\circ\text{C}$<br>1.4  | 1.7        | 2.1        | V           |
|               |                                     |   | $T_j = 125^\circ\text{C}$<br>2.0 |            |            |             |
| $V_{GE(th)}$  | Gate Threshold Voltage              | $V_{GE} = V_{CE}, I_C = 3\text{mA}$           | 5.0                              |            | 6.5        | V           |
| $I_{GES}$     | Gate – Emitter Leakage Current      | $V_{GE} = \pm 20\text{V}, V_{CE} = 0\text{V}$ |                                  |            | 500        | nA          |

**Dynamic Characteristics**

| <i>Symbol</i> | <i>Characteristic</i>        | <i>Test Conditions</i>   | <i>Min</i> | <i>Typ</i> | <i>Max</i> | <i>Unit</i> |    |
|---------------|------------------------------|--|------------|------------|------------|-------------|----|
| $C_{ies}$     | Input Capacitance            | $V_{GE} = 0\text{V}$   |            | 5340       |            | pF          |    |
| $C_{oes}$     | Output Capacitance           | $V_{CE} = 25\text{V}$  |            | 280        |            |             |    |
| $C_{res}$     | Reverse Transfer Capacitance | $f = 1\text{MHz}$  |            | 240        |            |             |    |
| $T_{d(on)}$   | Turn-on Delay Time           | Resistive Switching ( $25^\circ\text{C}$ )<br>$V_{GE} = 15\text{V}$<br>$V_{Bus} = 600\text{V}$<br>$I_C = 75\text{A}$<br>$R_G = 4.7\Omega$  |            | 260        |            | ns          |    |
| $T_r$         | Rise Time                    |  |            | 30         |            |             |    |
| $T_{d(off)}$  | Turn-off Delay Time          |  |            | 420        |            |             |    |
| $T_f$         | Fall Time                    |  |            | 70         |            |             |    |
| $T_{d(on)}$   | Turn-on Delay Time           | Inductive Switching ( $125^\circ\text{C}$ )<br>$V_{GE} = 15\text{V}$<br>$V_{Bus} = 600\text{V}$<br>$I_C = 75\text{A}$<br>$R_G = 4.7\Omega$ |            | 290        |            | ns          |    |
| $T_r$         | Rise Time                    |  |            | 45         |            |             |    |
| $T_{d(off)}$  | Turn-off Delay Time          |  |            | 520        |            |             |    |
| $T_f$         | Fall Time                    |  |            | 90         |            |             |    |
| $E_{on}$      | Turn-on Switching Energy     |  |            |            | 7          |             | mJ |
| $E_{off}$     | Turn-off Switching Energy    |  |            |            | 9.5        |             |    |

**Chopper diode ratings and characteristics**

| Symbol    | Characteristic                   | Test Conditions                                     | Min                 | Typ  | Max | Unit    |
|-----------|----------------------------------|---|---------------------|------|-----|---------|
| $V_F$     | Diode Forward Voltage            | $I_F = 30A$   |                     | 2.0  | 2.5 | V       |
|           |                                  | $I_F = 60A$   |                     | 2.3  |     |         |
|           |                                  | $I_F = 30A$   | $T_j = 125^\circ C$ | 1.8  |     |         |
| $I_{RM}$  | Maximum Reverse Leakage Current  | $V_R = 1200V$                                       | $T_j = 25^\circ C$  |      | 250 | $\mu A$ |
|           |                                  | $V_R = 1200V$                                       | $T_j = 125^\circ C$ |      | 500 |         |
| $C_T$     | Junction Capacitance             | $V_R = 200V$  |                     | 32   |     | pF      |
| $t_{rr}$  | Reverse Recovery Time            | $I_F = 1A, V_R = 30V$<br>$di/dt = 100A/\mu s$       | $T_j = 25^\circ C$  | 31   |     | ns      |
|           | Reverse Recovery Time            |   | $T_j = 25^\circ C$  | 370  |     |         |
|           |                                  |   | $T_j = 125^\circ C$ | 500  |     |         |
| $I_{RRM}$ | Maximum Reverse Recovery Current | $I_F = 30A$<br>$V_R = 800V$<br>$di/dt = 200A/\mu s$ | $T_j = 25^\circ C$  | 5    |     | A       |
|           |                                  |   | $T_j = 125^\circ C$ | 12   |     |         |
|           |                                  |   | $T_j = 25^\circ C$  | 660  |     |         |
| $Q_{rr}$  | Reverse Recovery Charge          |   | $T_j = 25^\circ C$  | 3450 |     | nC      |
|           |                                  |   | $T_j = 125^\circ C$ |      |     |         |
| $t_{rr}$  | Reverse Recovery Time            | $I_F = 30A$   | $T_j = 125^\circ C$ | 220  |     | ns      |
| $Q_{rr}$  | Reverse Recovery Charge          | $V_R = 800V$  |                     | 4650 |     | nC      |
| $I_{RRM}$ | Maximum Reverse Recovery Current | $di/dt = 1000A/\mu s$                               |                     | 37   |     | A       |

**Thermal and package characteristics**

| Symbol         | Characteristic  | Min   | Typ  | Max | Unit         |
|----------------|---|-------|------|-----|--------------|
| $R_{thJC}$     | Junction to Case Thermal Resistance   | IGBT  |      | 0.3 | $^\circ C/W$ |
|                |   | Diode |      | 1.1 |              |
| $R_{thJA}$     | Junction to Ambient (IGBT & Diode)  |       |      | 20  |              |
| $V_{ISOL}$     | RMS Isolation Voltage, any terminal to case $t = 1$ min, $I_{isol} < 1mA$ , 50/60Hz | 2500  |      |     | V            |
| $T_j, T_{STG}$ | Storage Temperature Range   | -55   |      | 150 | $^\circ C$   |
| $T_L$          | Max Lead Temp for Soldering: 0.063" from case for 10 sec                            |       |      | 300 |              |
| Torque         | Mounting torque (Mounting = 8-32 or 4mm Machine and terminals = 4mm Machine)        |       |      | 1.5 | N.m          |
| Wt             | Package Weight  |       | 29.2 |     | g            |

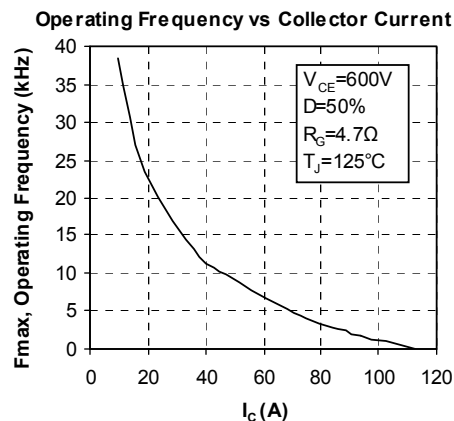
**Typical IGBT Performance Curve**

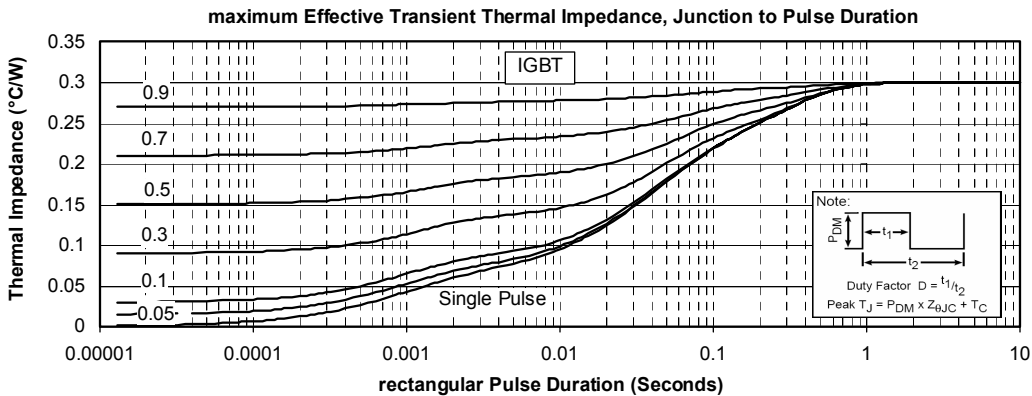
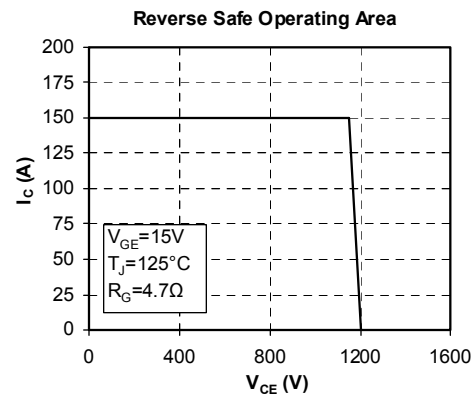
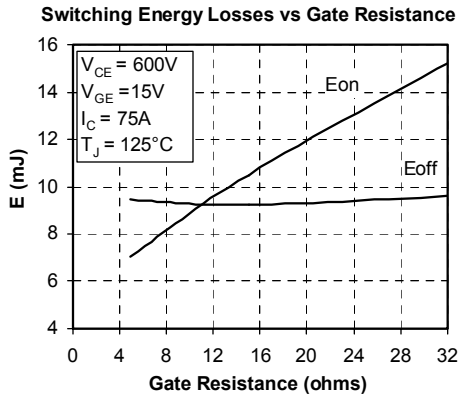
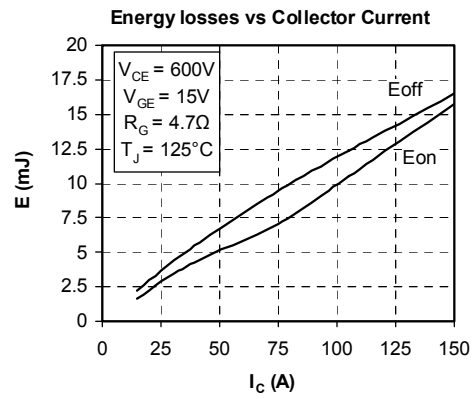
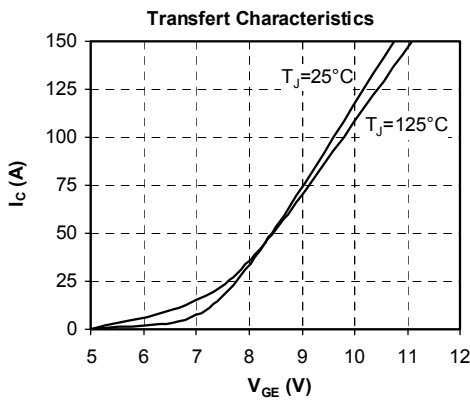
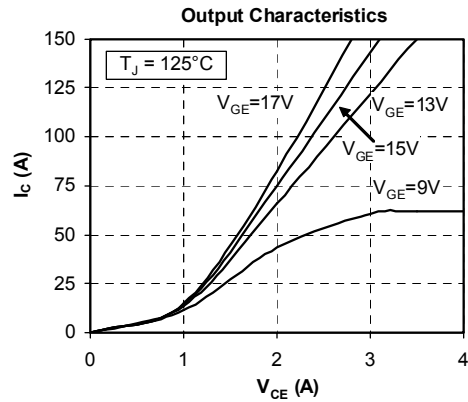
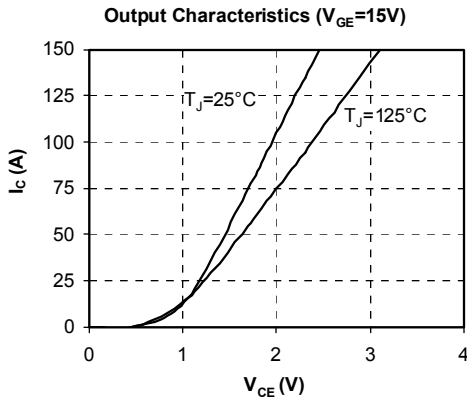

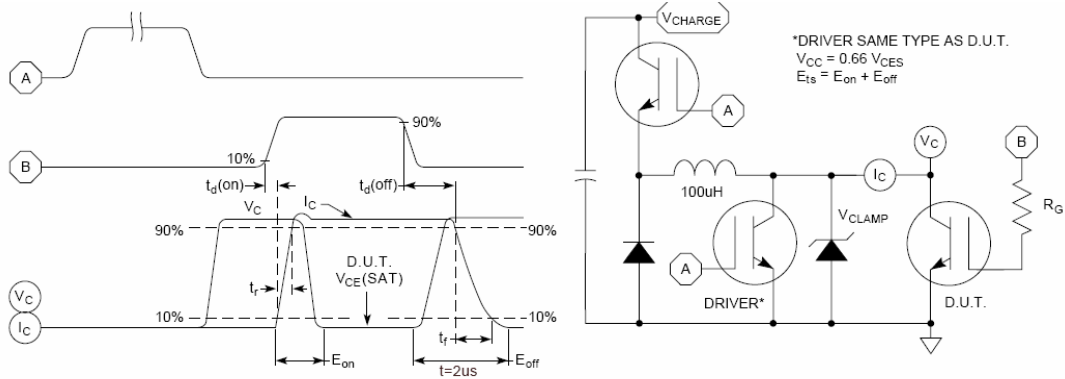

Figure 15, Switching Loss Test Circuit and Waveforms

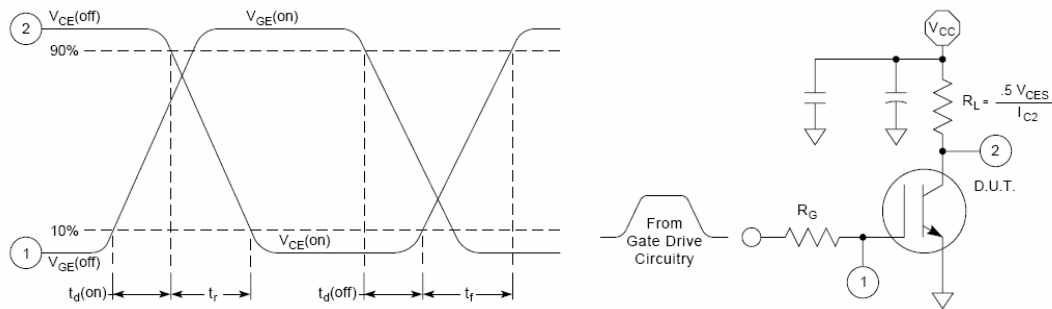

Figure 16, Resistive Switching Time Test Circuit and Waveforms

## Typical Diode Performance Curve

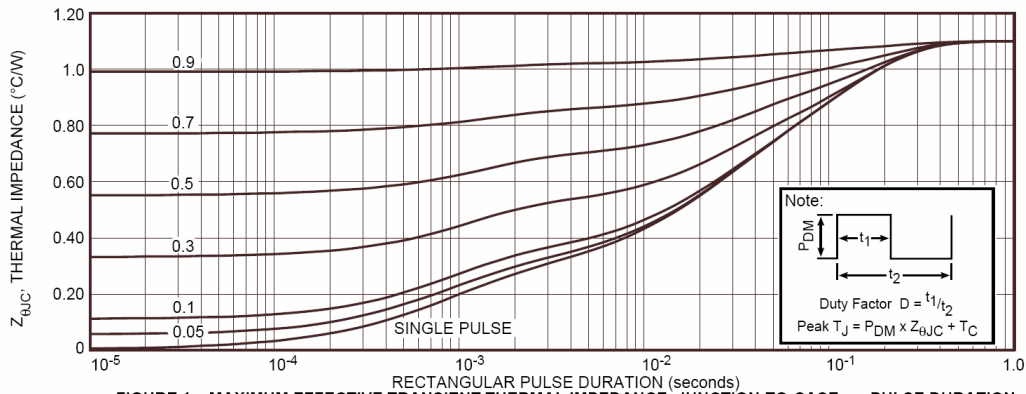

FIGURE 1a. MAXIMUM EFFECTIVE TRANSIENT THERMAL IMPEDANCE, JUNCTION-TO-CASE vs. PULSE DURATION

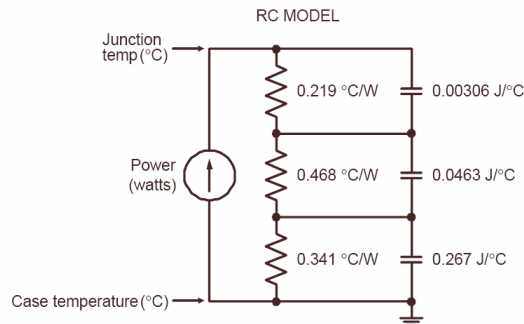

FIGURE 1b, TRANSIENT THERMAL IMPEDANCE MODEL

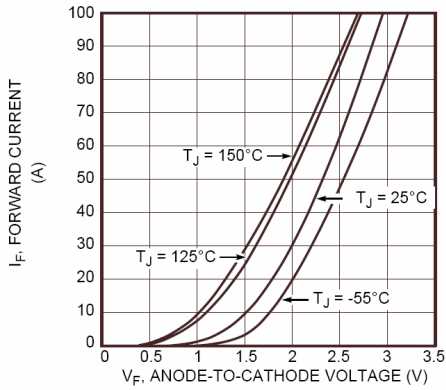

Figure 2. Forward Current vs. Forward Voltage

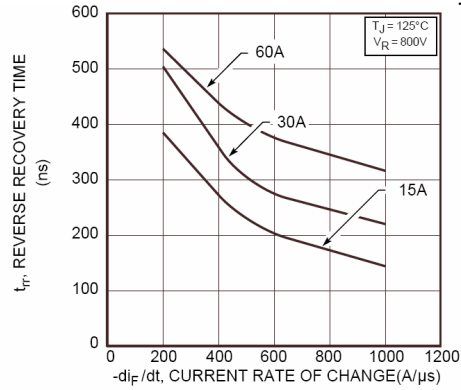

Figure 3. Reverse Recovery Time vs. Current Rate of Change

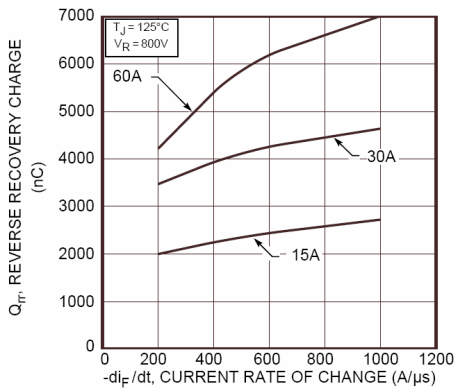

Figure 4. Reverse Recovery Charge vs. Current Rate of Change

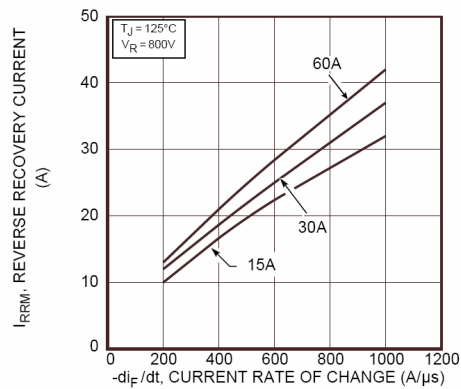

Figure 5. Reverse Recovery Current vs. Current Rate of Change

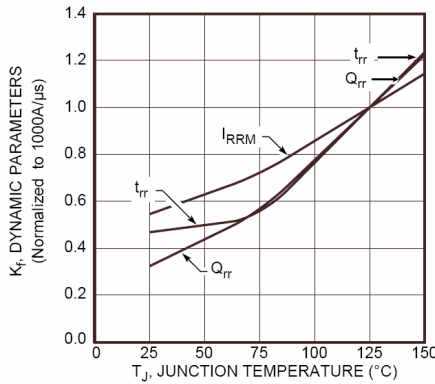

Figure 6. Dynamic Parameters vs. Junction Temperature

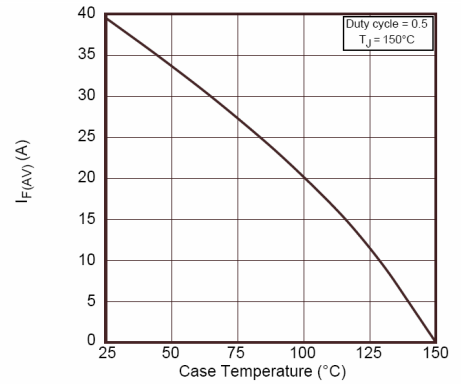

Figure 7. Maximum Average Forward Current vs. Case Temperature

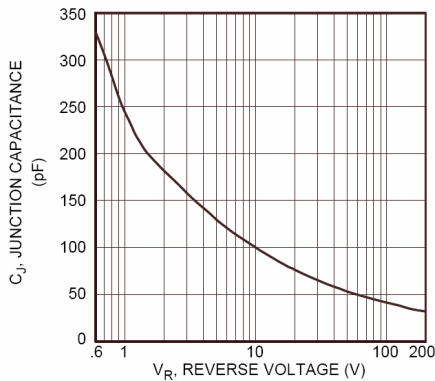

Figure 8. Junction Capacitance vs. Reverse Voltage

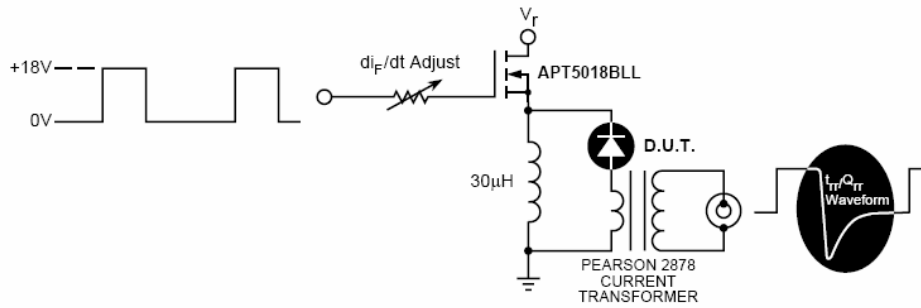

Figure 9. Diode Test Circuit

- 1  $I_F$  - Forward Conduction Current
- 2  $di_F/dt$  - Rate of Diode Current Change Through Zero Crossing.
- 3  $I_{RRM}$  - Maximum Reverse Recovery Current.
- 4  $t_{TR}$  - Reverse Recovery Time, measured from zero crossing where diode current goes from positive to negative, to the point at which the straight line through  $I_{RRM}$  and  $0.25 \cdot I_{RRM}$  passes through zero.
- 5  $Q_{TR}$  - Area Under the Curve Defined by  $I_{RRM}$  and  $t_{TR}$ .

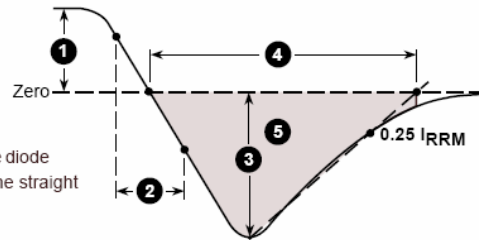
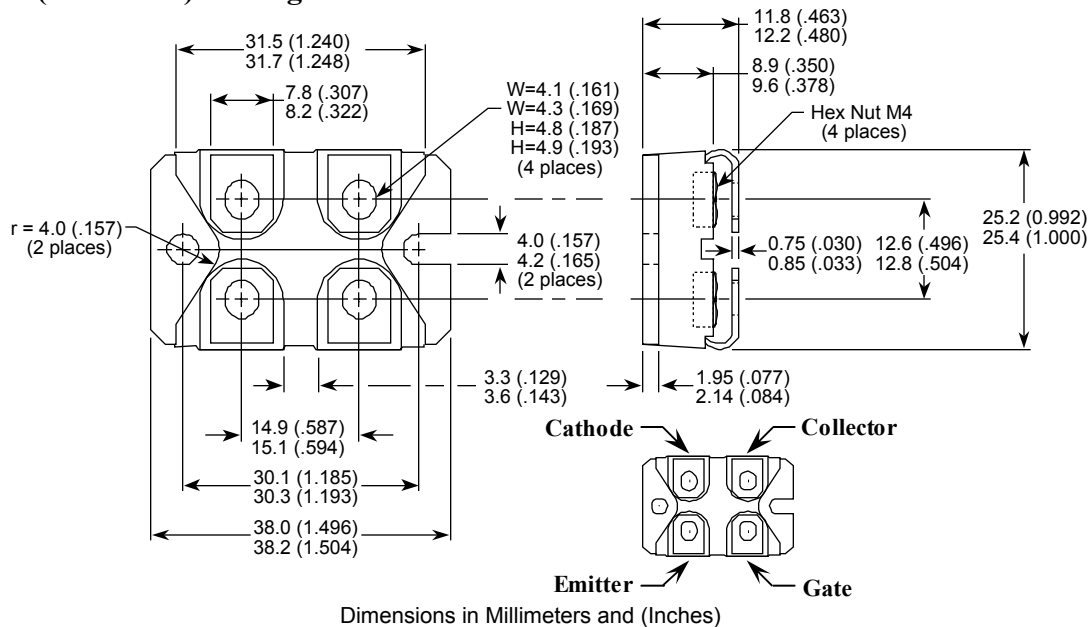

Figure 10. Diode Reverse Recovery Waveform and Definitions

## SOT-227 (ISOTOP<sup>®</sup>) Package Outline



ISOTOP<sup>®</sup> is a registered trademark of ST Microelectronics NV

Microsemi reserves the right to change, without notice, the specifications and information contained herein

Microsemi's products are covered by one or more of U.S. patents 4,895,810 5,045,903 5,089,434 5,182,234 5,019,522 5,262,336 6,503,786 5,256,583 4,748,103 5,283,202 5,231,474 5,434,095 5,528,058 and foreign patents. U.S. and Foreign patents pending. All Rights Reserved.

Компания «Океан Электроники» предлагает заключение долгосрочных отношений при поставках импортных электронных компонентов на взаимовыгодных условиях!

Наши преимущества:

- Поставка оригинальных импортных электронных компонентов напрямую с производств Америки, Европы и Азии, а так же с крупнейших складов мира;
- Широкая линейка поставок активных и пассивных импортных электронных компонентов (более 30 млн. наименований);
- Поставка сложных, дефицитных, либо снятых с производства позиций;
- Оперативные сроки поставки под заказ (от 5 рабочих дней);
- Экспресс доставка в любую точку России;
- Помощь Конструкторского Отдела и консультации квалифицированных инженеров;
- Техническая поддержка проекта, помощь в подборе аналогов, поставка прототипов;
- Поставка электронных компонентов под контролем ВП;
- Система менеджмента качества сертифицирована по Международному стандарту ISO 9001;
- При необходимости вся продукция военного и аэрокосмического назначения проходит испытания и сертификацию в лаборатории (по согласованию с заказчиком);
- Поставка специализированных компонентов военного и аэрокосмического уровня качества (Xilinx, Altera, Analog Devices, Intersil, Interpoint, Microsemi, Actel, Aeroflex, Peregrine, VPT, Syfer, Eurofarad, Texas Instruments, MS Kennedy, Miteq, Cobham, E2V, MA-COM, Hittite, Mini-Circuits, General Dynamics и др.);

Компания «Океан Электроники» является официальным дистрибьютором и эксклюзивным представителем в России одного из крупнейших производителей разъемов военного и аэрокосмического назначения «JONHON», а так же официальным дистрибьютором и эксклюзивным представителем в России производителя высокотехнологичных и надежных решений для передачи СВЧ сигналов «FORSTAR».



## JONHON

«JONHON» (основан в 1970 г.)

Разъемы специального, военного и аэрокосмического назначения:

(Применяются в военной, авиационной, аэрокосмической, морской, железнодорожной, горно- и нефтедобывающей отраслях промышленности)

«FORSTAR» (основан в 1998 г.)

ВЧ соединители, коаксиальные кабели, кабельные сборки и микроволновые компоненты:

(Применяются в телекоммуникациях гражданского и специального назначения, в средствах связи, РЛС, а так же военной, авиационной и аэрокосмической отраслях промышленности).



Телефон: 8 (812) 309-75-97 (многоканальный)

Факс: 8 (812) 320-03-32

Электронная почта: [ocean@oceanchips.ru](mailto:ocean@oceanchips.ru)

Web: <http://oceanchips.ru/>

Адрес: 198099, г. Санкт-Петербург, ул. Калинина, д. 2, корп. 4, лит. А