

8V to 18Vin, 15A Cool-Power ZVS Buck Regulator

Description

The PI34XX is a family of high efficiency DC-DC ZVS-Buck regulators integrating the controller, power switches and support components within a high density System-in-Package (SiP). The PI34XX is designed to achieve optimum efficiency at low input voltage ranges (8V to 18V). The utilization of zero current soft turn-on provided by the high performance ZVS topology within the PI34XX series increases point of load performance, providing best in class power efficiency with high throughput power. The PI34XX requires only an external inductor and minimal capacitors to form a complete DC-DC switching mode buck regulator.

Device	Output Voltage		Iout Max
	Set	Range	
PI3420-00-LGIZ	1.0V	1.0 to 1.4V	15A
PI3421-00-LGIZ	1.8V	1.4 to 2.0V	15A
PI3422-00-LGIZ	2.5V	2.0 to 3.1V	15A
PI3423-00-LGIZ	3.3V	2.3 to 4.1V	15A
PI3424-00-LGIZ	5.0V	3.3 to 6.5V	15A

Table 1 - PI34XX-00 Portfolio

The ZVS architecture enables high frequency operation while minimizing switching losses and maximizing efficiency. The high switching frequency operation reduces the size of the external filtering components, improves power density, and enables very fast dynamic response to line and load transients. The ZVS architecture enables operation up to 750 kHz while minimizing switching losses and the use of variable frequency extends high efficiency over a very wide dynamic range. The PI34XX series has a minimum on time of 20ns which enables large step down conversion ratios

Features

- High Efficiency ZVS-Buck Topology
- Input voltage range of 8V to 18V
- Very-Fast transient response
- Power-up into pre-biased load
- High accuracy pre-trimmed output voltage
- User adjustable soft-start & tracking
- Parallel capable with single wire current sharing
- Input Over/Under Voltage Lockout (OVLO/UVLO)
- Output Overvoltage Protection (OVP)
- Over Temperature Protection (OTP)
- Fast and slow current limits
- -40°C to 125°C operating range (T_j)

Applications

- High efficiency systems
- Computing, Communications, Industrial, Automotive Equipment

Package Information

- 10mm x 14mm x 2.6mm LGA SiP



Contents

Order Information	3	Output Current Limit Protection.....	22
Thermal, Storage, and Handling Information	3	Input Under-Voltage Lockout	23
Absolute Maximum Ratings.....	3	Input Over Voltage Lockout	23
Block Diagram.....	4	Output Over Voltage Protection.....	23
Pin Description.....	5	Over Temperature Protection.....	23
Package Pin-Out.....	5	Parallel Operation	23
PI3420-00 (1.0 Vout) Electrical Characteristics.....	6	Pulse Skip Mode (PSM)	24
PI3421-00 (1.8 Vout) Electrical Characteristics.....	9	Variable Frequency Operation	24
PI3422-00 (2.5 Vout) Electrical Characteristics.....	12	Application Description.....	24
PI3423-00 (3.3 Vout) Electrical Characteristics.....	15	Output Voltage Trim	24
PI3424-00 (5.0 Vout) Electrical Characteristics.....	18	Soft-Start Adjust and Tracking	25
Thermal Derating Curves	21	Inductor Pairing	26
Functional Description.....	22	Thermal Derating	26
ENABLE (EN)	22	Filter Considerations	27
Remote Sensing.....	22	Layout Guidelines.....	28
Switching Frequency Synchronization.....	22	Recommended PCB Footprint and Stencil	29
Soft-Start	22	Package Drawings	30
Output Voltage Trim.....	22		

Order Information

Cool-Power	Output Range		Iout Max	Package	Transport Media
	Set	Range			
PI3420-00-LGIZ	1.0V	1.0 to 1.4V	15A	10mm x 14mm 123-pin LGA	TRAY
PI3421-00-LGIZ	1.8V	1.4 to 2.0V	15A	10mm x 14mm 123-pin LGA	TRAY
PI3422-00-LGIZ	2.5V	2.0 to 3.1V	15A	10mm x 14mm 123-pin LGA	TRAY
PI3423-00-LGIZ	3.3V	2.3 to 4.1V	15A	10mm x 14mm 123-pin LGA	TRAY
PI3424-00-LGIZ	5.0V	3.3 to 6.5V	15A	10mm x 14mm 123-pin LGA	TRAY

Thermal, Storage, and Handling Information

Storage Temperature	-65°C to 150°C
Operating Junction Temperature	-40°C to 125°C
Soldering Temperature for 20 seconds	245°C
ESD Rating	2kV HBM

Absolute Maximum Ratings

VIN	-0.7V to 22V
VS1	-0.7 to 22V, 25V for 5ns, -4V for 5ns
VOUT	See relevant product section
SGND	100mA
PGD, SYNCO, SYNCI, EN, EAO, ADJ, TRK, ADR1, ADR2, SCL, SDA, REM	-0.3V to 5.5V / 5mA

Notes: At 25°C ambient temperature. Stresses beyond these limits may cause permanent damage to the device. Operation at these conditions or conditions beyond those listed in the Electrical Specifications table is not guaranteed. All voltage nodes are referenced to PGND unless otherwise noted.

Block Diagram

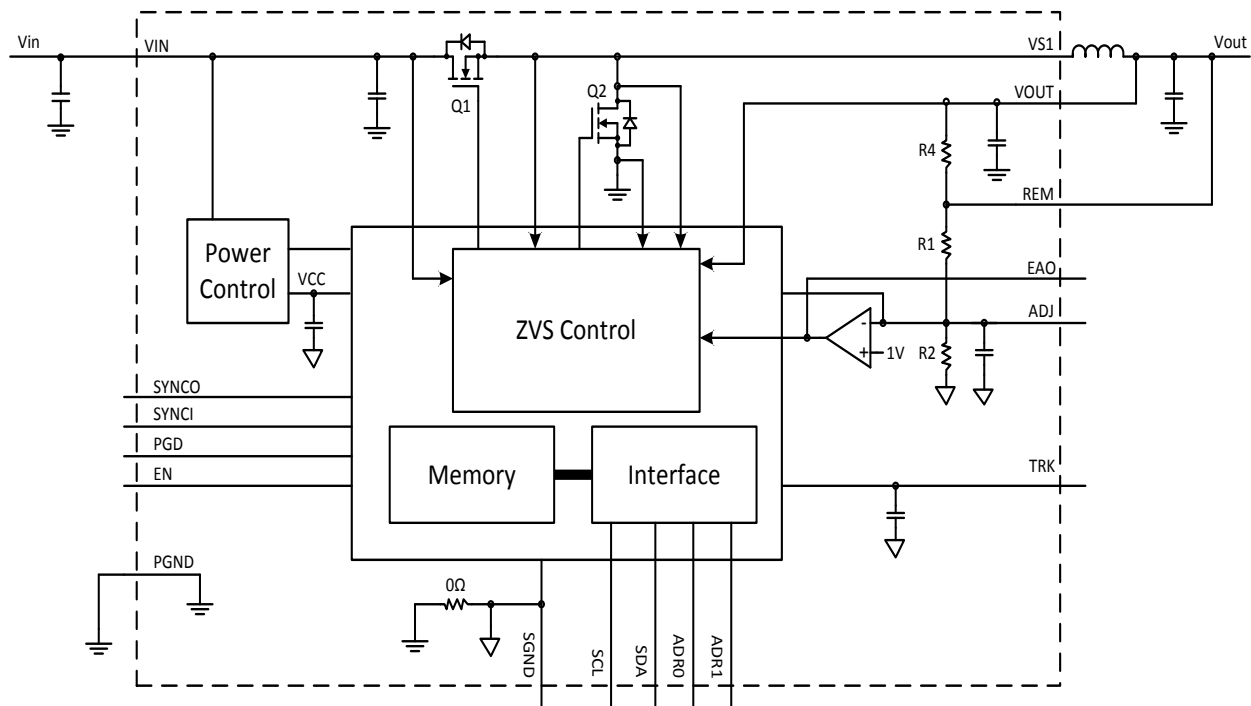
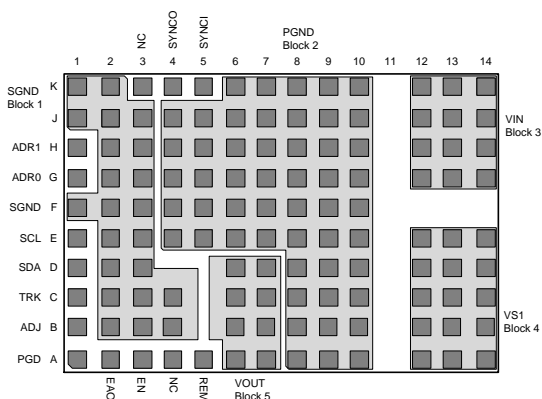

Figure 1: Simplified Block Diagram
(I²C pins SCL, SDA, ADRO, and ADR1 are for factory use only. Not for use in application.)

Pin Description

Name	Number	Description
SGND	Block 1	Signal ground: Internal logic ground for EA, TRK, SYNCI, SYNCO and ADJ. SGND and PGND are star connected within the regulator package.
PGND	Block 2	Power ground: VIN and VOUT power returns
VIN	Block 3	Input voltage: and sense for UVLO, OVLO and feed forward ramp
VOUT	Block 5	Output voltage: and sense for power switches and feed-forward ramp
VS1	Block 4	Switching node: and ZVS sense for power switches
PGD	A1	Parallel Good: Used for parallel timing management intended for lead regulator.
EAO	A2	Error amp output: External connection for additional compensation and current sharing.
EN	A3	Enable Input: Regulator enable control. Asserted high or left floating – regulator enabled; Asserted low, regulator output disabled.
REM	A5	Remote Sense: High side connection. Connect to output regulation point.
ADJ	B1	Adjust input: An external resistor may be connected between ADJ pin and SGND or VOUT to trim the output voltage up or down.
TRK	C1	Soft-start and track input: An external capacitor may be connected between TRK pin and SGND to decrease the rate of rise during soft-start.
NC	K3, A4	No Connect: Leave pins floating.
SYNCO	K4	Synchronization output: Outputs a high signal for ½ of the minimum period for synchronization of other regulators.
SYNCI	K5	Synchronization input: Synchronize to the falling edge of external clock frequency. SYNCI is a high impedance digital input node and should always be connected to SGND when not in use.
SDA	D1	Data Line: Connect to SGND. Factory use only. Not for use in application.
SCL	E1	Clock Line: Connect to SGND. Factory use only. Not for use in application.
ADR1	H1	Tri-state Address: No connect. Factory use only. Not for use in application.
ADRO	G1	Tri-state Address: No connect. Factory use only. Not for use in application.

Package Pin-Out



123-Lead LGA (10mm x 14mm)

Top view

Block 1: B2-4, C2-4, D2-3, E2-3, F1-3, G2-3, H2-3, J1-3, K1-2

Block 2: A8-10, B8-10, C8-10, D8-10, E4-10, F4-10, G4-10, H4-10, J4-10, K6-10

Block 3: G12-14, H12-14, J12-14, K12-14

Block 4: A12-14, B12-14, C12-14, D12-14, E12-14,

Block 5: A6-7, B6-7, C6-7, D6-7

PI3420-00 (1.0 Vout) Electrical Characteristics

Specifications apply for $-40^{\circ}\text{C} < T_J < 125^{\circ}\text{C}$, $V_{in} = 12\text{V}$, $L1 = 80\text{nH}$ (Note 1) unless other conditions are noted.

Parameter	Symbol	Min	Typ	Max	Units	Conditions
Input Specifications						
Input Voltage	V_{IN_DC}	8	12	18	V	Minimum 1mA load required
Input Current	I_{IN_DC}		1.437		A	$V_{in} = 12\text{V}$, $T_C = 25^{\circ}\text{C}$, $I_{out} = 15\text{A}$
Input Current At Output Short (fault condition duty cycle)	I_{IN_Short}			10	mA	Short at terminals
Input Quiescent Current	I_{Q_VIN}		2.6 4		mA	Disabled Enabled (no load)
Input Voltage Slew Rate	V_{IN_SR}			1	V/ μs	
Output Specifications						
Output Voltage Total Regulation	V_{OUT_DC}	0.987	1.0	1.013	V	Note 2
Output Voltage Trim Range	V_{OUT_DC}	1.0		1.4	V	Note 3
Line Regulation	$\Delta V_{OUT}(\Delta V_{IN})$		0.1		%	@ 25°C , $8\text{V} < V_{in} < 18\text{V}$
Load Regulation	$\Delta V_{OUT}(\Delta I_{OUT})$		0.2		%	@ 25°C , $0.5\text{A} < I_{out} < 15\text{A}$
Output Voltage Ripple	V_{OUT_AC}		27		mVp-p	$I_{out} = 7.5\text{A}$, $C_{out} = 8 \times 100\mu\text{F}$, 20MHz BW Note 4
Output Current	I_{OUT_DC}	0.001		15	A	
Current Limit	I_{OUT_CL}		18		A	$L1 = 80\text{nH}$
Protection						
UVLO Start Threshold	V_{UVLO_START}	7.20	7.60	8.00	V	
UVLO Stop Hysteresis	V_{UVLO_HYS}	4	5	6	%	
OVLO Stop Threshold	V_{OVLO}	19.71	20.75	21.78	V	
OVLO Start Hysteresis	V_{OVLO_HYS}	1.56	1.83	2.1	%	
UVLO/OVLO Fault Delay Time	t_{f_DLY}		128		Cycles	Number of the switching frequency cycles
UVLO/OVLO Response Time	t_f		500		ns	+1% overdrive
Output Over Voltage Protection	V_{OVP}		20		%	Above Set V_{OUT}
Over-Temperature Fault Threshold	T_{OTP}	130	135	140	$^{\circ}\text{C}$	
Over-Temperature Restart Hysteresis	T_{OTP_HYS}		30		$^{\circ}\text{C}$	

Note 1: All parameters reflect regulator and inductor system performance. Measurements were made using a standard PI34XX evaluation board with 3x4" dimensions and 4 layer, 2oz copper. Refer to inductor pairing table within Application Description section for specific inductor manufacturer and value.

Note 2: Regulator is assured to meet performance specifications by design, test correlation, characterization, and/or statistical process control.

Note 3: Output current capability may be limited and other performance may vary from noted electrical characteristics when switching frequency or V_{out} is modified.

Note 4: Refer to Output Ripple plots.

Note 5: Refer to Load Current vs. Ambient Temperature curves.

Note 6: Refer to Switching Frequency vs. Load current curves.

PI3420-00 (1.0 Vout) Electrical Characteristics

Specifications apply for $-40^{\circ}\text{C} < T_J < 125^{\circ}\text{C}$, $V_{in} = 12\text{V}$, $L1 = 80\text{nH}$ (Note 1) unless other conditions are noted.

Parameter	Symbol	Min	Typ	Max	Units	Conditions
Timing						
Switching Frequency	f_S		600		kHz	Note 6
Fault Restart Delay	t_{FR_DLY}		30		ms	
Sync In (SYNCI)						
Synchronization Frequency Range	Δf_{SYNCI}	50		110	%	Relative to set switching frequency. Note 3
SYNCI Threshold	V_{SYNCI}		2.5		V	
Sync Out (SYNCO)						
SYNCO High	V_{SYNCO_HI}	4.5			V	Source 1mA
SYNCO Low	V_{SYNCO_LO}			0.5	V	Sink 1mA
SYNCO Rise Time	t_{SYNCO_RT}		10		ns	20pF load
SYNCO Fall Time	t_{SYNCO_FT}		10		ns	20pF load
Soft Start And Tracking						
TRK Active Range (Nominal)	V_{TRK}	0		1.2	V	
TRK Enable Threshold	V_{TRK_OV}	20	40	60	mV	
Charge Current (Soft – Start)	I_{TRK}	-70	-50	-30	μA	
Discharge Current (Fault)	I_{TRK_DIS}		6.8		mA	
Soft-Start Time	t_{SS}		2.2		ms	$C_{TRK} = 0$
Enable						
High Threshold	V_{EN_HI}	0.9	1	1.1	V	
Low Threshold	V_{EN_LO}	0.7	0.8	0.9	V	
Threshold Hysteresis	V_{EN_HYS}	100	200	300	mV	
Enable Pull-Up Voltage (floating, unfaulted)	V_{EN_PU}		2		V	
Enable Pull-Down Voltage (floating, faulted)	V_{EN_PD}		0		V	
Source Current	I_{EN_SO}		-50		μA	
Sink Current	I_{EN_SK}		50		μA	

Note 1: All parameters reflect regulator and inductor system performance. Measurements were made using a standard PI34XX evaluation board with 3x4" dimensions and 4 layer, 2oz copper. Refer to inductor pairing table within Application Description section for specific inductor manufacturer and value.

Note 2: Regulator is assured to meet performance specifications by design, test correlation, characterization, and/or statistical process control.

Note 3: Output current capability may be limited and other performance may vary from noted electrical characteristics when switching frequency or Vout is modified.

Note 4: Refer to Output Ripple plots.

Note 5: Refer to Load Current vs. Ambient Temperature curves.

Note 6: Refer to Switching Frequency vs. Load current curves.

PI3420-00 (1.0 Vout) Electrical Characteristics

Efficiency at 25°C

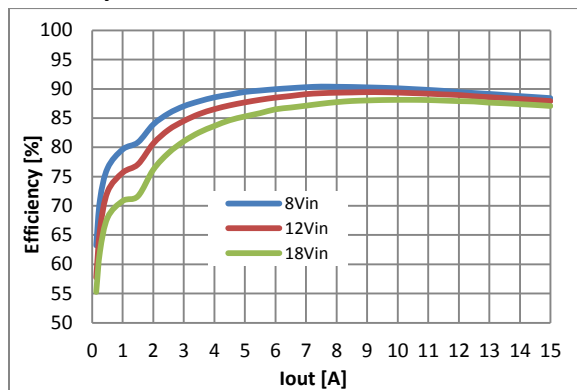

Regulator and inductor performance

342001

Transient Response: 7.5A to 15A, at 5A/μs

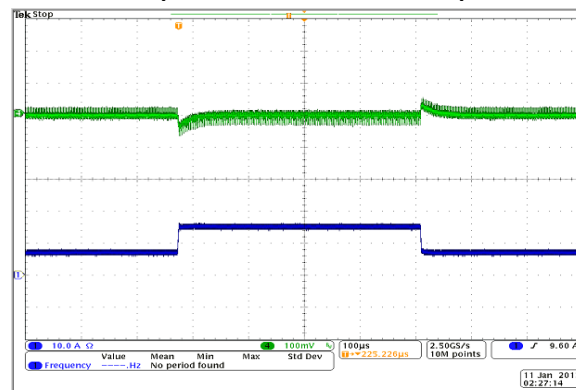

12Vin to 1.0Vout, Cout = 8X 100μF Ceramic
Vout (Ch4) = 100mV/Div, Iout (Ch1) = 10A/Div, 100uS/Div

342002

Short Circuit Test

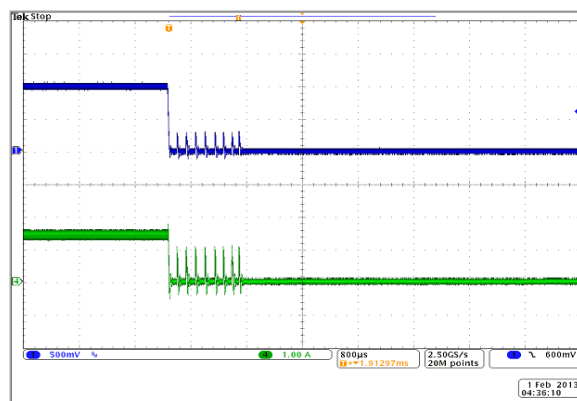

Vout (Ch1) = 500mV/Div, Iin (Ch4) = 1A/Div, 800us/Div

342003

Output Ripple: 12Vin, 1.0Vout at 15A

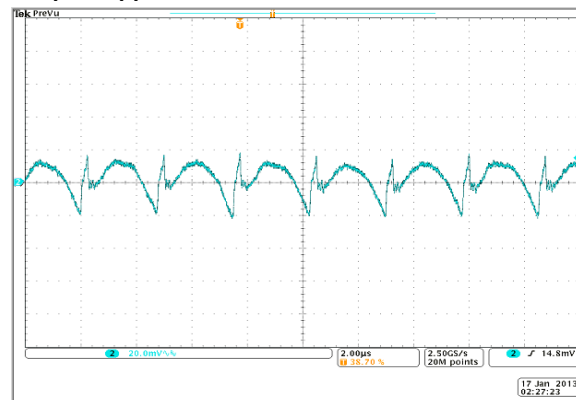

Cout = 8X 100μF Ceramic, Vout = 20mV/Div, 2.0us/Div

342004

Switching Frequency vs. Load Current

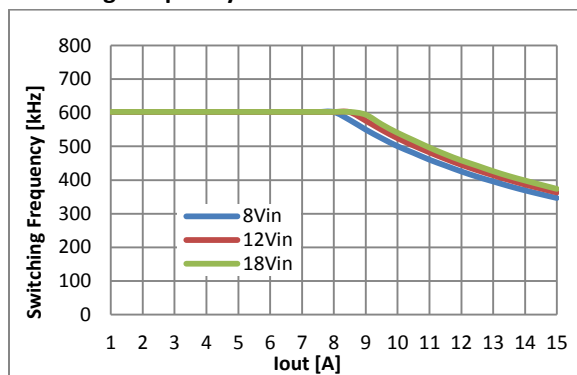

342005

Output ripple: 12Vin, 1.0Vout at 7.5A

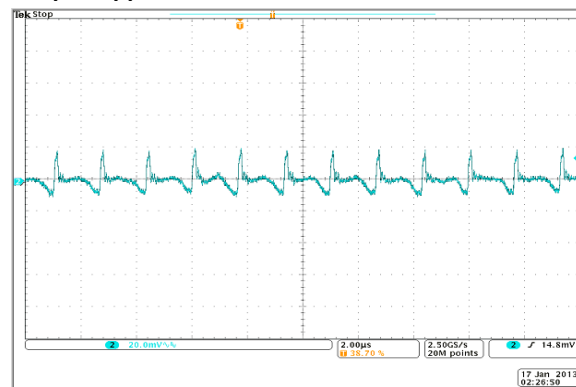

Cout = 8X 100μF Ceramic, Vout = 20mV/Div, 2.0us/Div

342006

PI3421-00 (1.8 Vout) Electrical Characteristics

Specifications apply for $-40^{\circ}\text{C} < T_J < 125^{\circ}\text{C}$, $V_{in} = 12\text{V}$, $L1 = 125\text{nH}$ (Note 1) unless other conditions are noted.

Parameter	Symbol	Min	Typ	Max	Units	Conditions
Input Specifications						
Input Voltage	V_{IN_DC}	8	12	18	V	
Input Current	I_{IN_DC}		2.46		A	$I_{out} = 15\text{A}$
Input Current At Output Short (fault condition duty cycle)	I_{IN_Short}			10	mA	Short at terminals
Input Quiescent Current	I_{Q_VIN}		2.6 4.3		mA	Disabled Enabled (no load)
Input Voltage Slew Rate	V_{IN_SR}			1	V/ μs	
Output Specifications						
Output Voltage Total Regulation	V_{OUT_DC}	1.776	1.8	1.823	V	Note 2
Output Voltage Trim Range	V_{OUT_DC}	1.4	1.8	2.0	V	Note 3
Line Regulation	$\Delta V_{OUT}(\Delta V_{IN})$		0.1		%	@25°C, $8\text{V} < V_{in} < 18\text{V}$
Load Regulation	$\Delta V_{OUT}(\Delta I_{OUT})$		0.1		%	@25°C, $0.5\text{A} < I_{out} < 15\text{A}$
Output Voltage Ripple	V_{OUT_AC}		20.2		mVp-p	$I_{out} = 7.5\text{A}$, $C_{out} = 8 \times 100\mu\text{F}$, 20MHz BW Note 4
Output Current	I_{OUT_DC}			15	A	
Current Limit	I_{OUT_CL}		18		A	$L1 = 125\text{nH}$
Protection						
UVLO Start Threshold	V_{UVLO_START}	7.20	7.60	8.00	V	
UVLO Stop Hysteresis	V_{UVLO_HYS}	4	5	6	%	
OVLO Stop Threshold	V_{OVLO}	19.71	20.75	21.78	V	
OVLO Start Hysteresis	V_{OVLO_HYS}	1.56	1.83	2.1	%	
UVLO/OVLO Fault Delay Time	t_{f_DLY}		128		Cycles	Number of the switching frequency cycles
UVLO/OVLO Response Time	t_f		500		ns	+1% overdrive
Output Over Voltage Protection	V_{OVP}		20		%	Above Set V_{OUT}
Over-Temperature Fault Threshold	T_{OTP}	130	135	140	°C	
Over-Temperature Restart Hysteresis	T_{OTP_HYS}		30		°C	

Note 1: All parameters reflect regulator and inductor system performance. Measurements were made using a standard PI34XX evaluation board with 3x4" dimensions and 4 layer, 2oz copper. Refer to inductor pairing table within Application Description section for specific inductor manufacturer and value.

Note 2: Regulator is assured to meet performance specifications by design, test correlation, characterization, and/or statistical process control.

Note 3: Output current capability may be limited and other performance may vary from noted electrical characteristics when switching frequency or V_{out} is modified.

Note 4: Refer to Output Ripple plots.

Note 5: Refer to Load Current vs. Ambient Temperature curves.

Note 6: Refer to Switching Frequency vs. Load current curves.

PI3421-00 (1.8 Vout) Electrical Characteristics

Specifications apply for $-40^{\circ}\text{C} < T_J < 125^{\circ}\text{C}$, $V_{in} = 12\text{V}$, $L1 = 125\text{nH}$ (Note 1) unless other conditions are noted.

Parameter	Symbol	Min	Typ	Max	Units	Conditions
Timing						
Switching Frequency	f_S		550		kHz	Note 6
Fault Restart Delay	t_{FR_DLY}		30		ms	
Sync In (SYNCI)						
Synchronization Frequency Range	Δf_{SYNCI}	50		110	%	Relative to set switching frequency. Note 3
SYNCI Threshold	V_{SYNCI}		2.5		V	
Sync Out (SYNCO)						
SYNCO High	V_{SYNCO_HI}	4.5			V	Source 1mA
SYNCO Low	V_{SYNCO_LO}			0.5	V	Sink 1mA
SYNCO Rise Time	t_{SYNCO_RT}		10		ns	20pF load
SYNCO Fall Time	t_{SYNCO_FT}		10		ns	20pF load
Soft Start And Tracking						
TRK Active Range (Nominal)	V_{TRK}	0		1.2	V	
TRK Enable Threshold	V_{TRK_OV}	20	40	60	mV	
Charge Current (Soft – Start)	I_{TRK}	-70	-50	-30	μA	
Discharge Current (Fault)	I_{TRK_DIS}		6.8		mA	
Soft-Start Time	t_{SS}		2.2		ms	$C_{TRK} = 0$
Enable						
High Threshold	V_{EN_HI}	0.9	1	1.1	V	
Low Threshold	V_{EN_LO}	0.7	0.8	0.9	V	
Threshold Hysteresis	V_{EN_HYS}	100	200	300	mV	
Enable Pull-Up Voltage (floating, unfaulted)	V_{EN_PU}		2		V	
Enable Pull-Down Voltage (floating, faulted)	V_{EN_PD}		0		V	
Source Current	I_{EN_SO}		-50		μA	
Sink Current	I_{EN_SK}		50		μA	

Note 1: All parameters reflect regulator and inductor system performance. Measurements were made using a standard PI34XX evaluation board with 3x4" dimensions and 4 layer, 2oz copper. Refer to inductor pairing table within Application Description section for specific inductor manufacturer and value.

Note 2: Regulator is assured to meet performance specifications by design, test correlation, characterization, and/or statistical process control.

Note 3: Output current capability may be limited and other performance may vary from noted electrical characteristics when switching frequency or Vout is modified.

Note 4: Refer to Output Ripple plots.

Note 5: Refer to Load Current vs. Ambient Temperature curves.

Note 6: Refer to Switching Frequency vs. Load current curves.

PI3421-00 (1.8 Vout) Electrical Characteristics

Efficiency at 25°C

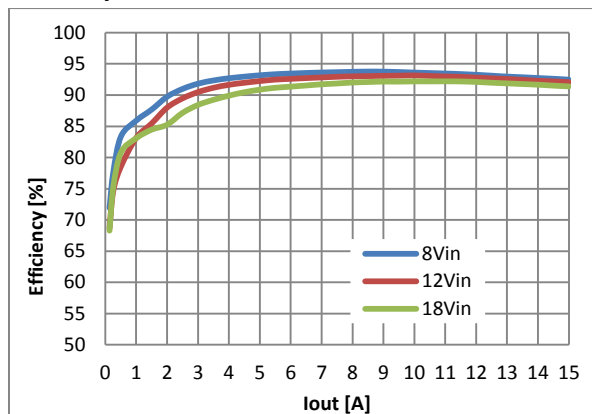

Regulator and inductor performance

342101

Transient Response: 7A to 15A, at 5A/μs

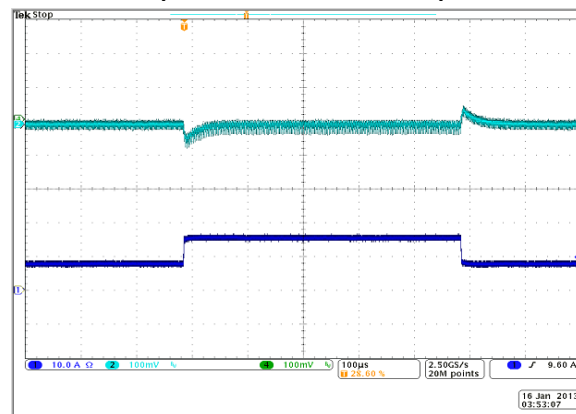

12Vin to 1.8Vout, Cout = 8X 100μF Ceramic

Vout (Ch2) = 100mV/Div, lin (Ch1) = 10A/Div, 100us/Div

342102

Short Circuit Test

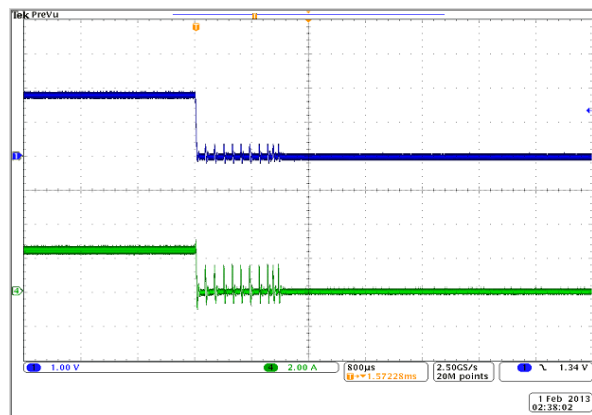

Vout (Ch1) = 1V/Div, lin (Ch2) = 2A/Div, 800us/Div

342103

Output Ripple: 12Vin, 1.8Vout at 15A

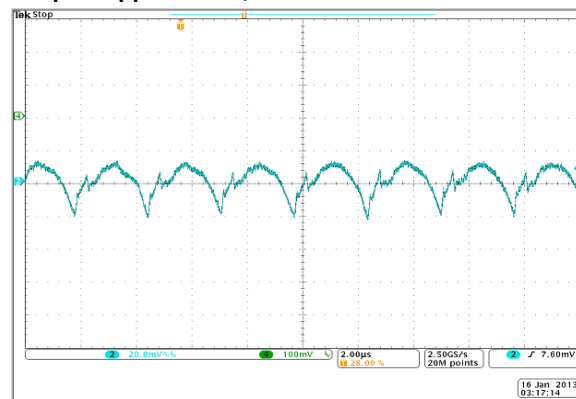

Cout = 8X 100μF Ceramic, Vout = 20mV/Div, 2.0us/Div

342104

Switching Frequency vs. Load Current

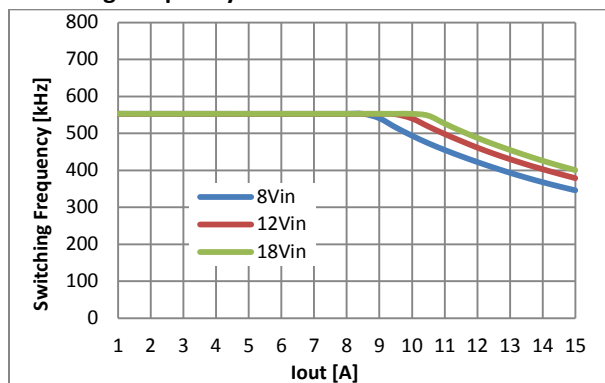

342105

Output ripple: 12Vin, 1.8Vout at 7.5A

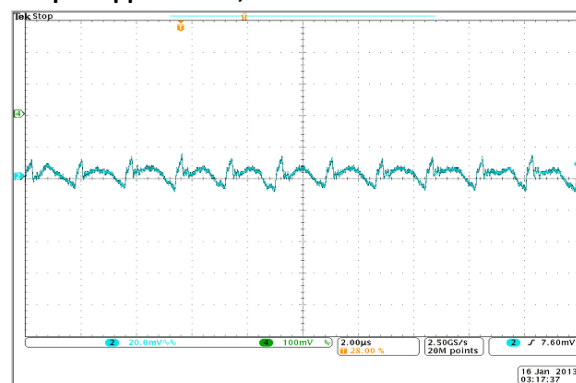

Cout = 8X 100μF Ceramic, Vout = 20mV/Div, 2.0us/Div

342106

PI3422-00 (2.5 Vout) Electrical Characteristics

Specifications apply for $-40^{\circ}\text{C} < T_J < 125^{\circ}\text{C}$, $V_{in} = 12\text{V}$, $L1=125\text{nH}$ (Note 1) unless other conditions are noted.

Parameter	Symbol	Min	Typ	Max	Units	Conditions
Input Specifications						
Input Voltage	V_{IN_DC}	8	12	18	V	Note 7
Input Current	I_{IN_DC}		3.37		A	$V_{in} = 12\text{V}$, $T_C = 25^{\circ}\text{C}$, $I_{out}=15\text{A}$
Input Current At Output Short (fault condition duty cycle)	I_{IN_Short}			10	mA	Short at terminals
Input Quiescent Current	I_{Q_VIN}		2.6 4.0		mA	Disabled Enabled (no load)
Input Voltage Slew Rate	V_{IN_SR}			1	V/ μs	
Output Specifications						
Output Voltage Total Regulation	V_{OUT_DC}	2.465	2.5	2.535	V	Note 2.
Output Voltage Trim Range	V_{OUT_DC}	2.0	2.5	3.1	V	Note 3 Note 7
Line Regulation	$\Delta V_{OUT} (\Delta V_{IN})$		0.1		%	@ 25°C , $8\text{V} < V_{in} < 18\text{V}$
Load Regulation	$\Delta V_{OUT} (\Delta I_{OUT})$		0.1		%	@ 25°C , $0.5\text{A} < I_{out} < 15\text{A}$
Output Voltage Ripple	V_{OUT_AC}		14		mVp-p	$I_{out}=7.5\text{A}$, $C_{out}=8 \times 100\mu\text{F}$, 20MHz BW
Output Current	I_{OUT_DC}			15	A	Note 7
Current Limit	I_{OUT_CL}		18		A	$L = 125\text{nH}$
Protection						
UVLO Start Threshold	V_{UVLO_START}	7.20	7.60	8.00	V	
UVLO Stop Hysteresis	V_{UVLO_HYS}	4	5	6	%	
OVLO Stop Threshold	V_{OVLO}	19.71	20.75	21.78	V	
OVLO Start Hysteresis	V_{OVLO_HYS}	1.56	1.83	2.1	%	
UVLO/OVLO Fault Delay Time	t_{f_DLY}		128		Cycles	Number of the switching frequency cycles
UVLO/OVLO Response Time	t_f		500		ns	+1% overdrive
Output Over Voltage Protection	V_{OVP}		20		%	Above Set V_{OUT}
Over-Temperature Fault Threshold	T_{OTP}	130	135	140	$^{\circ}\text{C}$	
Over-Temperature Restart Hysteresis	T_{OTP_HYS}		30		$^{\circ}\text{C}$	

Note 1: All parameters reflect regulator and inductor system performance. Measurements were made using a standard PI34XX evaluation board with 3x4" dimensions and 4 layer, 2oz copper. Refer to inductor pairing table within Application Description section for specific inductor manufacturer and value.

Note 2: Regulator is assured to meet performance specifications by design, test correlation, characterization, and/or statistical process control.

Note 3: Output current capability may be limited and other performance may vary from noted electrical characteristics when switching frequency or V_{out} is modified.

Note 4: Refer to Output Ripple plots.

Note 5: Refer to Load Current vs. Ambient Temperature curves.

Note 6: Refer to Switching Frequency vs. Load current curves.

Note 7: Minimum 5V between V_{in} - V_{out} must be maintained or a minimum load of 1mA required.

PI3422-00 (2.5 Vout) Electrical Characteristics

Specifications apply for $-40^{\circ}\text{C} < T_J < 125^{\circ}\text{C}$, $V_{in} = 12\text{V}$, $L1 = 125\text{nH}$ (Note 1) unless other conditions are noted.

Parameter	Symbol	Min	Typ	Max	Units	Conditions
Timing						
Switching Frequency	f_s		650		kHz	Note 6
Fault Restart Delay	t_{FR_DLY}		30		ms	
Sync In (SYNCI)						
Synchronization Frequency Range	Δf_{SYNCI}	50		110	%	Relative to set switching frequency. Note 3
SYNCI Threshold	V_{SYNCI}		2.5		V	
Sync Out (SYNCO)						
SYNCO High	V_{SYNCO_HI}	4.5			V	Source 1mA
SYNCO Low	V_{SYNCO_LO}			0.5	V	Sink 1mA
SYNCO Rise Time	t_{SYNCO_RT}		10		ns	20pF load
SYNCO Fall Time	t_{SYNCO_FT}		10		ns	20pF load
Soft Start And Tracking						
TRK Active Range (Nominal)	V_{TRK}	0		1.2	V	
TRK Enable Threshold	V_{TRK_OV}	20	40	60	mV	
Charge Current (Soft – Start)	I_{TRK}	-70	-50	-30	μA	
Discharge Current (Fault)	I_{TRK_DIS}		6.8		mA	
Soft-Start Time	t_{SS}		2.2		ms	$C_{TRK} = 0$
Enable						
High Threshold	V_{EN_HI}	0.9	1	1.1	V	
Low Threshold	V_{EN_LO}	0.7	0.8	0.9	V	
Threshold Hysteresis	V_{EN_HYS}	100	200	300	mV	
Enable Pull-Up Voltage (floating, unfaulted)	V_{EN_PU}		2		V	
Enable Pull-Down Voltage (floating, faulted)	V_{EN_PD}		0		V	
Source Current	I_{EN_SO}		-50		μA	
Sink Current	I_{EN_SK}		50		μA	

Note 1: All parameters reflect regulator and inductor system performance. Measurements were made using a standard PI34XX evaluation board with 3x4" dimensions and 4 layer, 2oz copper. Refer to inductor pairing table within Application Description section for specific inductor manufacturer and value.

Note 2: Regulator is assured to meet performance specifications by design, test correlation, characterization, and/or statistical process control.

Note 3: Output current capability may be limited and other performance may vary from noted electrical characteristics when switching frequency or Vout is modified.

Note 4: Refer to Output Ripple plots.

Note 5: Refer to Load Current vs. Ambient Temperature curves.

Note 6: Refer to Switching Frequency vs. Load current curves.

Note 7: Minimum 5V between Vin-Vout must be maintained or a minimum load of 1mA required.

PI3422-00 (2.5 Vout) Electrical Characteristics

Efficiency at 25°C

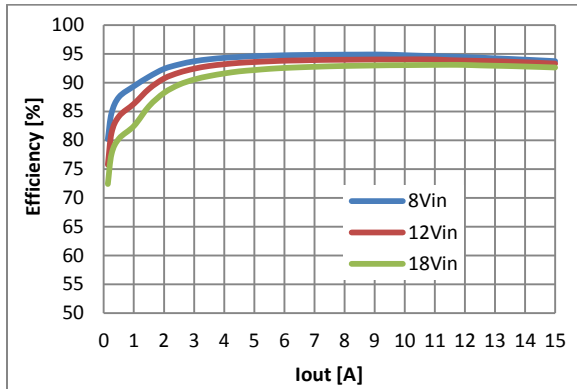

Regulator and inductor performance

342201

Transient Response: 7.5A to 15A, at 5A/μs

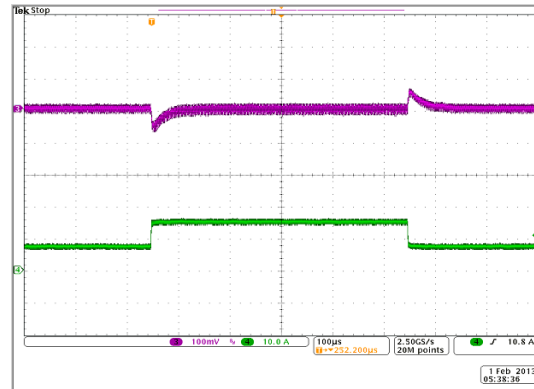

12Vin to 2.5Vout, Cout = 8 x 100μF Ceramic

342202

Vout (Ch2) = 100mV/Div, Iout (Ch1) = 10A/Div, 100us/Div

Short Circuit

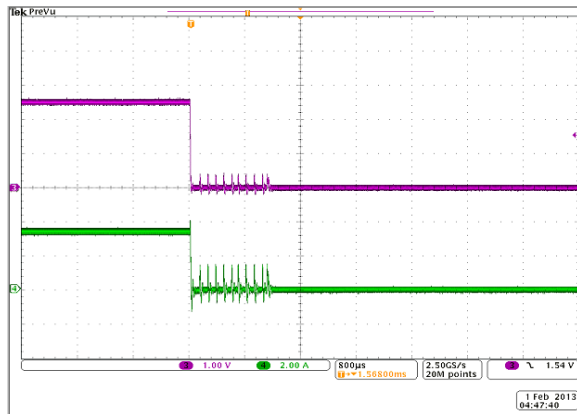

Vout (Ch3) = 1V/Div, Iin (Ch4) = 2A/Div, 800us/Div

342203

Output Ripple: 12Vin, 2.5Vout at 15A

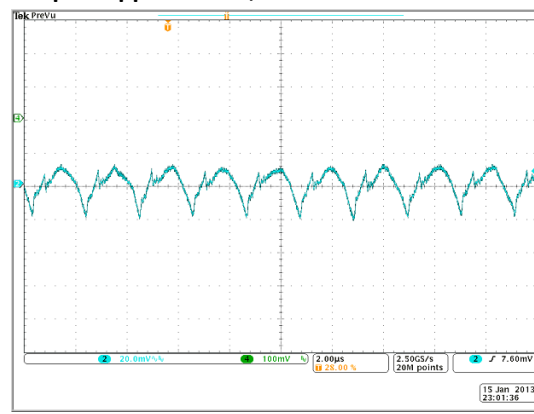

Vout = 20mV/Div, 2.0us/Div, Cout = 8 x 100μF Ceramic

342204

Switching Frequency vs. Load Current

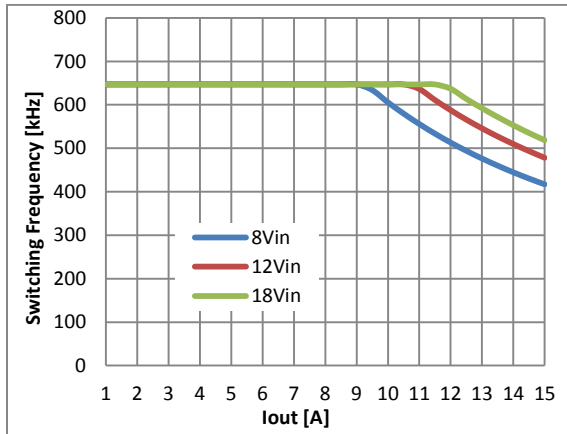

342205

Output Ripple: 12Vin, 2.5Vout at 7.5A

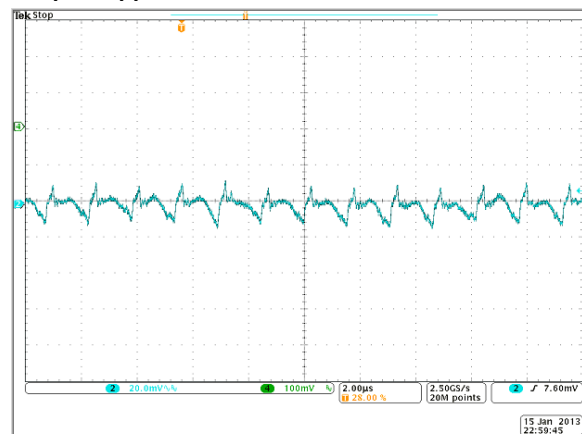

Vout = 20mV/Div, 2.0us/Div, Cout = 8 x 100μF Ceramic

342206

PI3423-00 (3.3 Vout) Electrical Characteristics

Specifications apply for $-40^{\circ}\text{C} < T_J < 125^{\circ}\text{C}$, $V_{\text{in}} = 12\text{V}$, $L_1 = 150\text{nH}$ (Note 1) unless other conditions are noted.

Parameter	Symbol	Min	Typ	Max	Units	Conditions
Input Specifications						
Input Voltage	$V_{\text{IN_DC}}$	8	12	18	V	Note 7
Input Current	$I_{\text{IN_DC}}$		4.43		A	$V_{\text{in}} = 12\text{V}$, $T_C = 25^{\circ}\text{C}$, $I_{\text{out}} = 15\text{A}$
Input Current At Output Short (fault condition duty cycle)	$I_{\text{IN_Short}}$			10	mA	Short at terminals
Input Quiescent Current	$I_{\text{Q_VIN}}$		2.6 4		mA	Disabled Enabled (no load)
Input Voltage Slew Rate	$V_{\text{IN_SR}}$			1	V/ μs	
Output Specifications						
Output Voltage Total Regulation	$V_{\text{OUT_DC}}$	3.25	3.30	3.36	V	Note 2
Output Voltage Trim Range	$V_{\text{OUT_DC}}$	2.3	3.3	4.1	V	Note 3 Note 7
Line Regulation	$\Delta V_{\text{OUT}}(\Delta V_{\text{IN}})$		0.10		%	@ 25°C , $8 < V_{\text{in}} < 18\text{V}$
Load Regulation	$\Delta V_{\text{OUT}}(\Delta I_{\text{OUT}})$		0.10		%	@ 25°C , $0.5\text{A} < I_{\text{out}} < 15\text{A}$
Output Voltage Ripple	$V_{\text{OUT_AC}}$		17		mVp-p	$I_{\text{out}} = 7.5\text{A}$, $C_{\text{out}} = 8 \times 100\mu\text{F}$, 20MHz BW Note 4
Output Current	$I_{\text{OUT_DC}}$			15	A	Note 7
Current Limit	$I_{\text{OUT_CL}}$		18		A	$L_1 = 150\text{nH}$
Protection						
UVLO Start Threshold	$V_{\text{UVLO_START}}$	7.20	7.60	8.00	V	
UVLO Stop Hysteresis	$V_{\text{UVLO_HYS}}$	4	5	6	%	
OVLO Stop Threshold	V_{OVLO}	19.71	20.75	21.78	V	
OVLO Start Hysteresis	$V_{\text{OVLO_HYS}}$	1.56	1.83	2.1	%	
UVLO/OVLO Fault Delay Time	$t_{\text{f_DLY}}$		128		Cycles	Number of the switching frequency cycles
UVLO/OVLO Response Time	t_{f}		500		ns	+1% overdrive
Output Over Voltage Protection	V_{OVP}		20		%	Above Set V_{OUT}
Over-Temperature Fault Threshold	T_{OTP}	130	135	140	$^{\circ}\text{C}$	
Over-Temperature Restart Hysteresis	$T_{\text{OTP_HYS}}$		30		$^{\circ}\text{C}$	

Note 1: All parameters reflect regulator and inductor system performance. Measurements were made using a standard PI34XX evaluation board with 3x4" dimensions and 4 layer, 2oz copper. Refer to inductor pairing table within Application Description section for specific inductor manufacturer and value.

Note 2: Regulator is assured to meet performance specifications by design, test correlation, characterization, and/or statistical process control.

Note 3: Output current capability may be limited and other performance may vary from noted electrical characteristics when switching frequency or V_{out} is modified.

Note 4: Refer to Output Ripple plots.

Note 5: Refer to Load Current vs. Ambient Temperature curves.

Note 6: Refer to Switching Frequency vs. Load current curves.

Note 7: Minimum 5V between V_{in} - V_{out} must be maintained or a minimum load of 1mA required.

PI3423-00 (3.3 Vout) Electrical Characteristics

Specifications apply for $-40^{\circ}\text{C} < T_j < 125^{\circ}\text{C}$, $V_{in} = 12\text{V}$, $L1 = 150\text{nH}$ (Note 1) unless other conditions are noted.

Parameter	Symbol	Min	Typ	Max	Units	Conditions
Timing						
Switching Frequency	f_s		700		kHz	Note 6
Fault Restart Delay	t_{FR_DLY}		30		ms	
Sync In (SYNCI)						
Synchronization Frequency Range	Δf_{SYNCI}	50		110	%	Relative to set switching frequency. Note 3.
SYNCI Threshold	V_{SYNCI}		2.5		V	
Sync Out (SYNCO)						
SYNCO High	V_{SYNCO_HI}	4.5			V	Source 1mA
SYNCO Low	V_{SYNCO_LO}			0.5	V	Sink 1mA
SYNCO Rise Time	t_{SYNCO_RT}		10		ns	20pF load
SYNCO Fall Time	t_{SYNCO_FT}		10		ns	20pF load
Soft Start And Tracking						
TRK Active Range (Nominal)	V_{TRK}	0		1.2	V	
TRK Enable Threshold	V_{TRK_OV}	20	40	60	mV	
Charge Current (Soft – Start)	I_{TRK}	-70	-50	-30	μA	
Discharge Current (Fault)	I_{TRK_DIS}		6.8		mA	
Soft-Start Time	t_{SS}		2.2		ms	$C_{TRK} = 0$
Enable						
High Threshold	V_{EN_HI}	0.9	1	1.1	V	
Low Threshold	V_{EN_LO}	0.7	0.8	0.9	V	
Threshold Hysteresis	V_{EN_HYS}	100	200	300	mV	
Enable Pull-Up Voltage (floating, unfaulted)	V_{EN_PU}		2		V	
Enable Pull-Down Voltage (floating, faulted)	V_{EN_PD}		0		V	
Source Current	I_{EN_SO}		-50		μA	
Sink Current	I_{EN_SK}		50		μA	

Note 1: All parameters reflect regulator and inductor system performance. Measurements were made using a standard PI34XX evaluation board with 3x4" dimensions and 4 layer, 2oz copper. Refer to inductor pairing table within Application Description section for specific inductor manufacturer and value.

Note 2: Regulator is assured to meet performance specifications by design, test correlation, characterization, and/or statistical process control.

Note 3: Output current capability may be limited and other performance may vary from noted electrical characteristics when switching frequency or Vout is modified.

Note 4: Refer to Output Ripple plots.

Note 5: Refer to Load Current vs. Ambient Temperature curves.

Note 6: Refer to Switching Frequency vs. Load current curves.

Note 7: Minimum 5V between Vin-Vout must be maintained or a minimum load of 1mA required.

PI3423-00 (3.3 Vout) Electrical Characteristics

Efficiency at 25°C

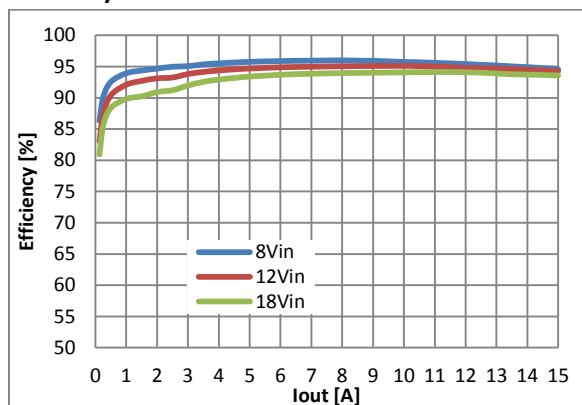

Regulator and inductor performance

342301

Transient Response: 7.5 to 15A, at 5A/μs

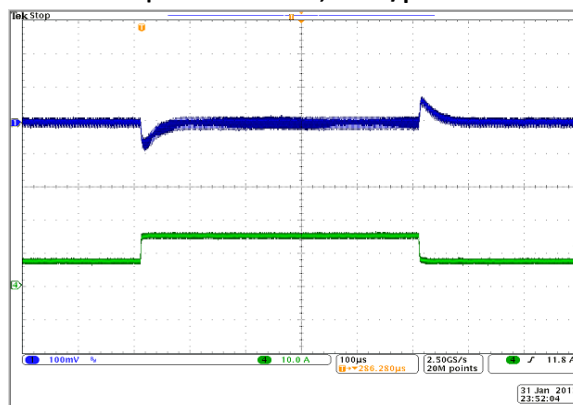

12Vin to 3.3Vout, Cout = 8 x 100μF Ceramic

342302

Vout (Ch2) = 100mV/Div, Iout (Ch1) = 10A/Div, 100us/Div

Short Circuit

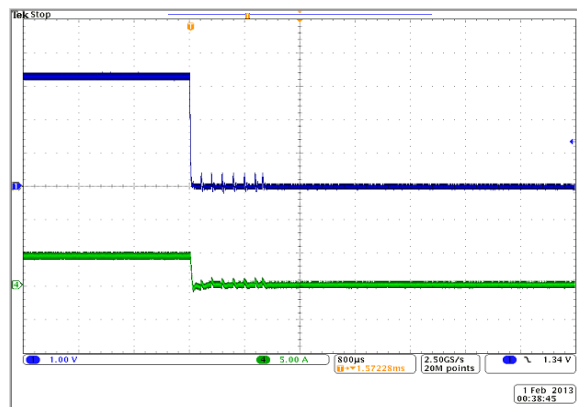

Vout (Ch1) = 1V/Div, Iin (Ch4) = 5A/Div, 800us/Div

342303

Output Ripple: 12Vin, 3.3Vout at 15A

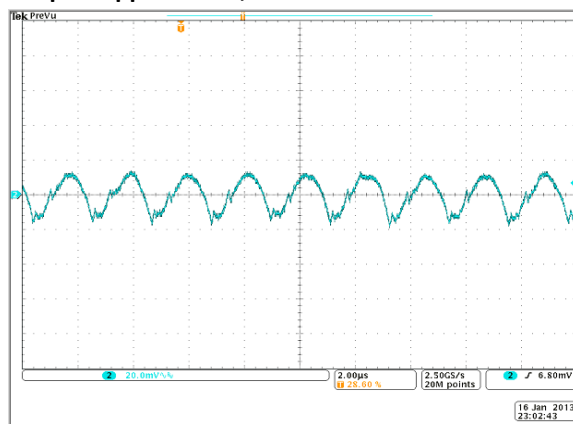

Vout = 20mV/Div, 2.0us/Div, Cout = 8 x 100μF Ceramic

342304

Switching Frequency vs. Load Current

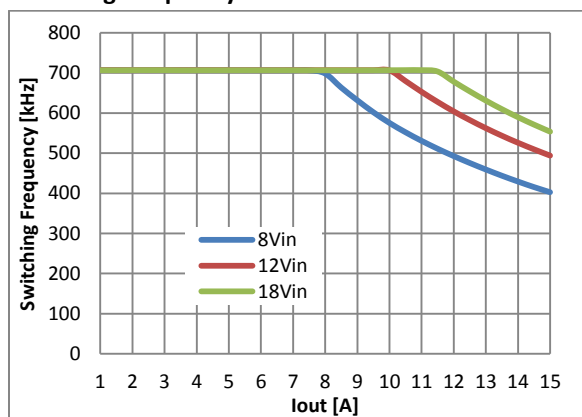

342305

Output Ripple: 12Vin, 3.3Vout at 7.5A

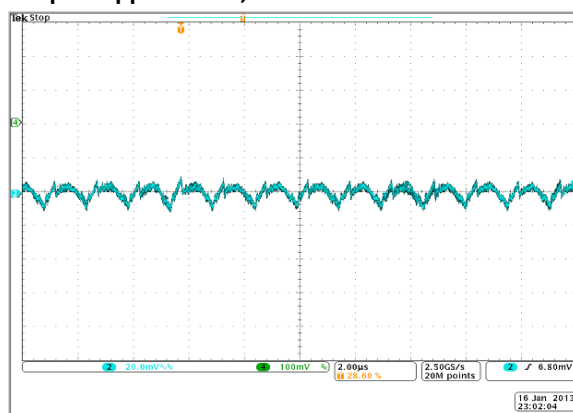

Vout = 20mV/Div, 2.0us/Div, Cout = 8 x 100μF Ceramic

342306

PI3424-00 (5.0 Vout) Electrical Characteristics

Specifications apply for $-40^{\circ}\text{C} < T_j < 125^{\circ}\text{C}$, $V_{in} = 12\text{V}$, $L1 = 150\text{nH}$ (Note 1) unless other conditions are noted.

Parameter	Symbol	Min	Typ	Max	Units	Conditions
Input Specifications						
Input Voltage	V_{IN_DC}	8	12	18	V	Note 7
Input Current	I_{IN_DC}		6.57		A	$V_{in} = 12\text{V}$, $T_c = 25^{\circ}\text{C}$, $I_{out} = 15\text{A}$
Input Current At Output Short (fault condition duty cycle)	I_{IN_Short}			10	mA	Short at terminals
Input Quiescent Current	I_{Q_VIN}		2.6 4		mA	Disabled Enabled (no min. load)
Input Voltage Slew Rate	V_{IN_SR}			1	V/ μs	
Output Specifications						
Output Voltage Total Regulation	V_{OUT_DC}	4.93	5	5.07	V	Note 2
Output Voltage Trim Range	V_{OUT_DC}	3.3		6.5	V	Note 3 Note 7
Line Regulation	$\Delta V_{OUT}(\Delta V_{IN})$		0.10		%	@ 25°C , $8 < V_{in} < 18\text{V}$
Load Regulation	$\Delta V_{OUT}(\Delta I_{OUT})$		0.10		%	@ 25°C , $1.0\text{A} < I_{out} < 15\text{A}$
Output Voltage Ripple	V_{OUT_AC}		20.8		mVp-p	$I_{out} = 7.5\text{A}$, $C_{out} = 8 \times 47\mu\text{F}$, 20MHz BW Note 4
Output Current	I_{OUT_DC}			15	A	Note 7
Current Limit	I_{OUT_CL}		18		A	$L1 = 150\text{nH}$
Protection						
UVLO Start Threshold	V_{UVLO_START}	7.20	7.60	8.00	V	
UVLO Stop Hysteresis	V_{UVLO_HYS}	4	5	6	%	
OVLO Stop Threshold	V_{OVLO}	19.71	20.75	21.78	V	
OVLO Start Hysteresis	V_{OVLO_HYS}	1.56	1.83	2.1	%	
UVLO/OVLO Fault Delay Time	t_{f_DLY}		128		Cycles	Number of the switching frequency cycles
UVLO/OVLO Response Time	t_f		500		ns	+1% overdrive
Output Over Voltage Protection	V_{OVP}		20		%	Above Set V_{OUT}
Over-Temperature Fault Threshold	T_{OTP}	130	135	140	$^{\circ}\text{C}$	
Over-Temperature Restart Hysteresis	T_{OTP_HYS}		30		$^{\circ}\text{C}$	

Note 1: All parameters reflect regulator and inductor system performance. Measurements were made using a standard PI34XX evaluation board with 3x4" dimensions and 4 layer, 2oz copper. Refer to inductor pairing table within Application Description section for specific inductor manufacturer and value.

Note 2: Regulator is assured to meet performance specifications by design, test correlation, characterization, and/or statistical process control.

Note 3: Output current capability may be limited and other performance may vary from noted electrical characteristics when switching frequency or V_{out} is modified.

Note 4: Refer to Output Ripple plots.

Note 5: Refer to Load Current vs. Ambient Temperature curves.

Note 6: Refer to Switching Frequency vs. Load current curves.

Note 7: Minimum 5V between V_{in} - V_{out} must be maintained or a minimum load of 1mA required.

PI3424-00 (5.0 Vout) Electrical Characteristics

Specifications apply for $-40^{\circ}\text{C} < T_j < 125^{\circ}\text{C}$, $V_{in} = 12\text{V}$, $L_1 = 150\text{nH}$ (Note 1) unless other conditions are noted.

Parameter	Symbol	Min	Typ	Max	Units	Conditions
Timing						
Switching Frequency	f_s		750		kHz	Note 6
Fault Restart Delay	t_{FR_DLY}		30		ms	
Sync In (SYNCI)						
Synchronization Frequency Range	Δf_{SYNCI}	50		110	%	Relative to set switching frequency. Note 3.
SYNCI Threshold	V_{SYNCI}		2.5		V	
Sync Out (SYNCO)						
SYNCO High	V_{SYNCO_HI}	4.5			V	Source 1mA
SYNCO Low	V_{SYNCO_LO}			0.5	V	Sink 1mA
SYNCO Rise Time	t_{SYNCO_RT}		10		ns	20pF load
SYNCO Fall Time	t_{SYNCO_FT}		10		ns	20pF load
Soft Start And Tracking						
TRK Active Range (Nominal)	V_{TRK}	0		1.2	V	
TRK Enable Threshold	V_{TRK_OV}	20	40	60	mV	
Charge Current (Soft – Start)	I_{TRK}	-70	-50	-30	μA	
Discharge Current (Fault)	I_{TRK_DIS}		6.8		mA	
Soft-Start Time	t_{SS}		2.2		ms	$C_{TRK} = 0$
Enable						
High Threshold	V_{EN_HI}	0.9	1	1.1	V	
Low Threshold	V_{EN_LO}	0.7	0.8	0.9	V	
Threshold Hysteresis	V_{EN_HYS}	100	200	300	mV	
Enable Pull-Up Voltage (floating, unfaulted)	V_{EN_PU}		2		V	
Enable Pull-Down Voltage (floating, faulted)	V_{EN_PD}		0		V	
Source Current	I_{EN_SO}		-50		μA	
Sink Current	I_{EN_SK}		50		μA	

Note 1: All parameters reflect regulator and inductor system performance. Measurements were made using a standard PI34XX evaluation board with 3x4" dimensions and 4 layer, 2oz copper. Refer to inductor pairing table within Application Description section for specific inductor manufacturer and value.

Note 2: Regulator is assured to meet performance specifications by design, test correlation, characterization, and/or statistical process control.

Note 3: Output current capability may be limited and other performance may vary from noted electrical characteristics when switching frequency or Vout is modified.

Note 4: Refer to Output Ripple plots.

Note 5: Refer to Load Current vs. Ambient Temperature curves.

Note 6: Refer to Switching Frequency vs. Load current curves.

Note 7: Minimum 5V between Vin-Vout must be maintained or a minimum load of 1mA required.

PI3424-00 (5.0 Vout) Electrical Characteristics

Efficiency at 25°C

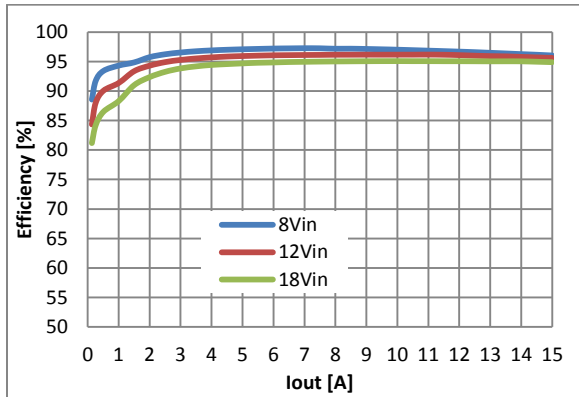

Regulator and inductor performance

342401

Transient Response: 7.5 to 15A, at 5A/μs

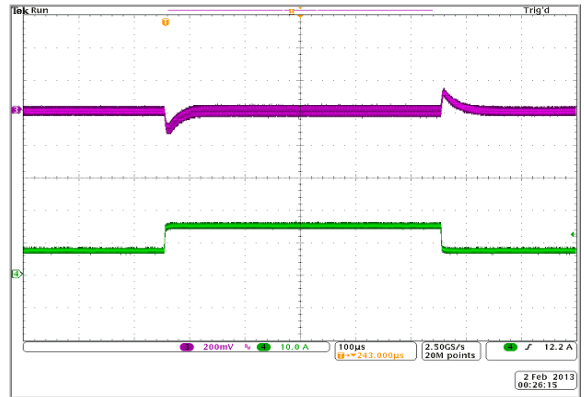

12Vin to 5.0Vout, Cout = 8 x 47μF Ceramic

342402

Vout (Ch2) = 200mV/Div, Iout (Ch1) = 10A/Div, 100us/Div

Short Circuit

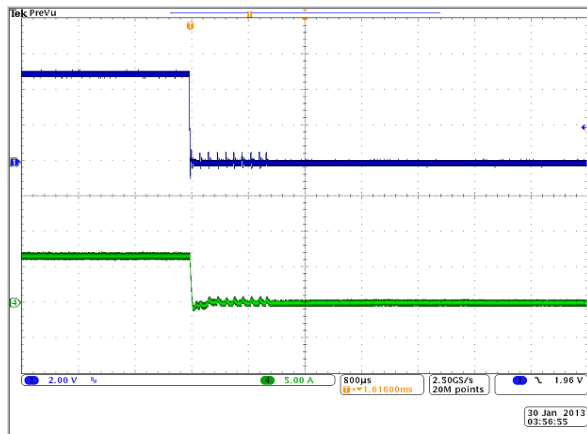

Vout (Ch1) = 2V/Div, Iin (Ch4) = 5A/Div, 800us/Div

342403

Output Ripple: 12Vin, 5.0Vout at 15A

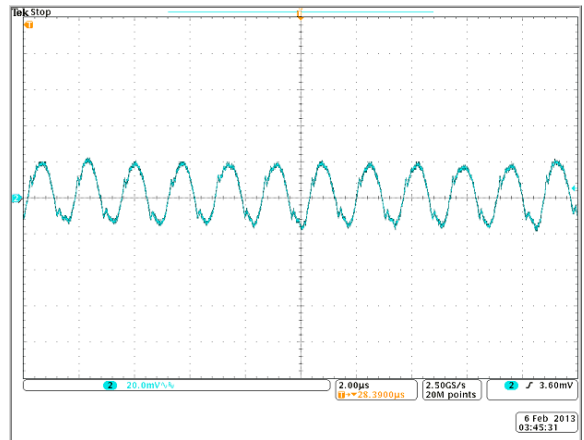

Vout = 20mV/Div, 2.0us/Div, Cout = 8 x 47μF Ceramic

342404

Switching Frequency vs. Load Current

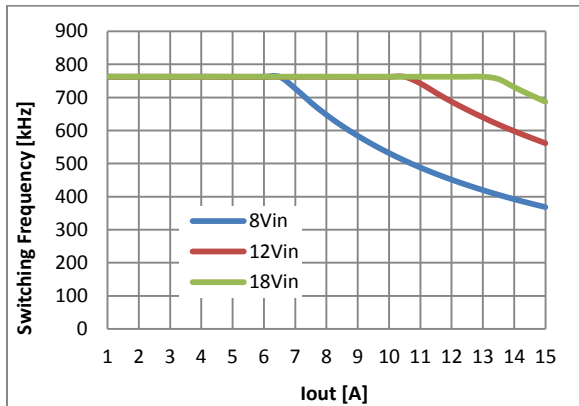

342405

Output Ripple: 12Vin, 5.0Vout at 7.5A

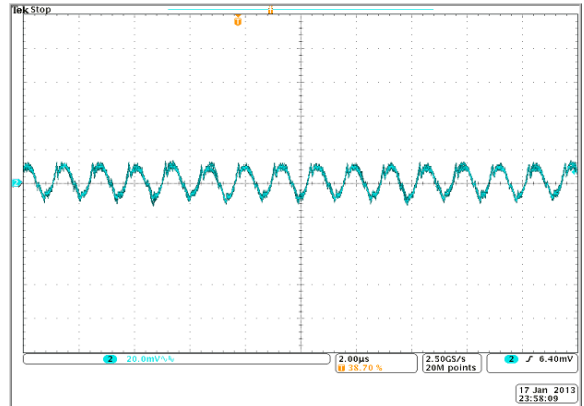

Vout = 20mV/Div, 2.0us/Div, Cout = 8 x 47μF Ceramic

342406

Thermal Derating Curves

PI3420 - Load Current vs. Ambient Temperature, 0 LFM

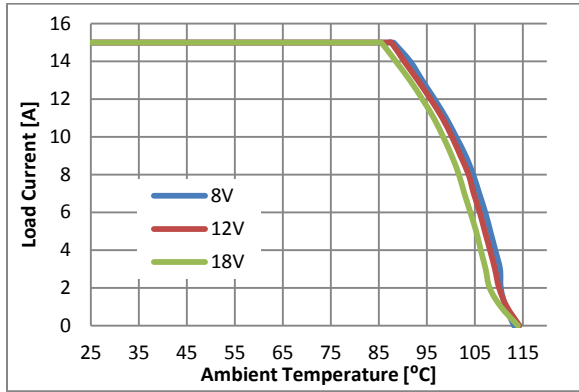

Regulator and inductor performance

342007

PI3421 - Load Current vs. Ambient Temperature, 0 LFM

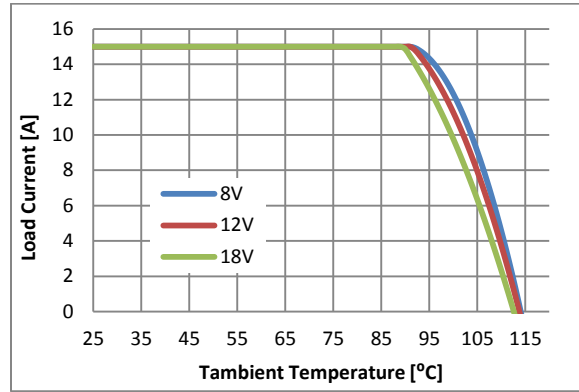

Regulator and inductor performance

342107

PI3422 - Load Current vs. Ambient Temperature, 0 LFM

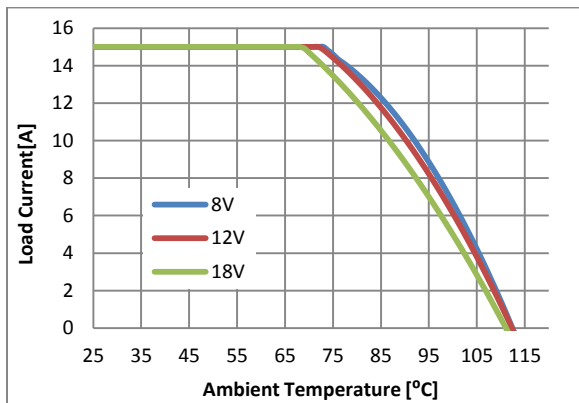

Regulator and inductor performance

342207

PI3423 - Load Current vs. Ambient Temperature, 0 LFM

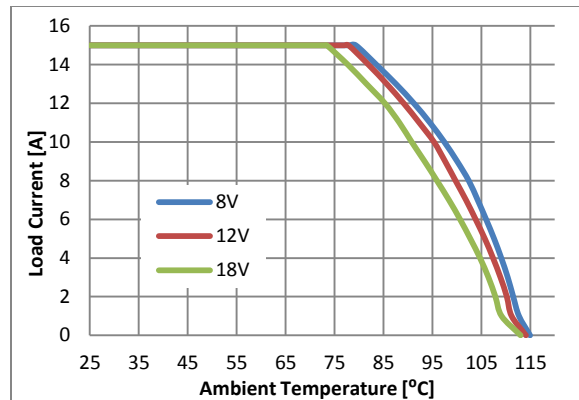

Regulator and inductor performance

342307

PI3424 - Load Current vs. Ambient Temperature, 0 LFM

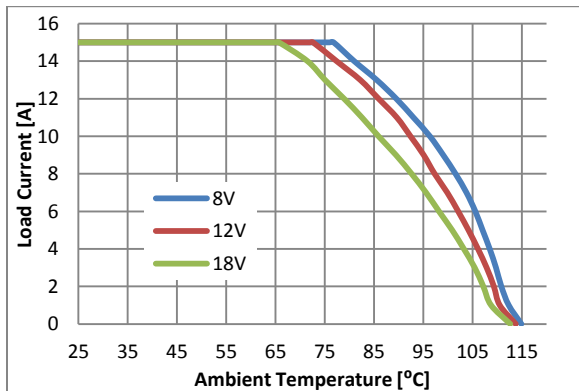

Regulator and inductor performance

342407

Functional Description

The PI34XX is a family of highly integrated ZVS-Buck regulators. The PI34XX has a set output voltage that is trimmable within a prescribed range shown in Table 2. Performance and maximum output current are characterized with a specific external power inductor (see Table 5).

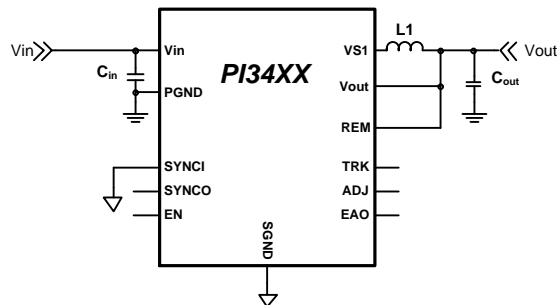

Figure 2 - ZVS-Buck with required components

For basic operation, Figure 2 shows the connections and components required. No additional design or settings are required.

ENABLE (EN)

EN is the enable pin of the regulator. The EN Pin is referenced to SGND and permits the user to turn the regulator on or off. The EN polarity is a positive logic assertion. If the EN pin is left floating or asserted high, the regulator output is enabled. Pulling EN pin below 0.8 Vdc with respect to SGND will disable the regulator output.

Remote Sensing

An internal 100Ω resistor is connected between REM pin and VOUT pin to provide regulation when the REM connection is broken. Referring to Figure 2, it is important to note that L1 and Cout are the output filter and the local sense point for the power supply output. As such, the REM pin should be connected at Cout as the default local sense connection unless remote sensing to compensate additional distribution losses in the system. The REM pin should not be left floating.

Switching Frequency Synchronization

The SYNCI input allows the user to synchronize the controller switching frequency by an external clock

referenced to SGND. The external clock can synchronize the unit between 50% and 110% of the preset switching frequency (f_s).

The PI34XX syncs to the falling edge of the applied clock providing 180° phase shift from SYNCO. This allows for the paralleling of two PI34XX devices. When using the internal oscillator, the SYNCO pin provides a 5V clock that can be used to sync other regulators. Therefore, one PI34XX can act as the lead regulator and have additional PI34XXs running in parallel and interleaved.

Soft-Start

The PI34XX includes an internal soft-start capacitor to ramp the output voltage in 2ms from 0V to full output voltage. Connecting an external capacitor from the TRK pin to SGND will increase the start-up ramp period. See, “Soft Start Adjustment and Track,” in the Applications Description section for more details.

Output Voltage Trim

The PI34XX output voltage can be trimmed up from the preset output by connecting a resistor from ADJ pin to SGND and can be trimmed down by connecting a resistor from ADJ pin to VOUT. The Table 2 defines the voltage ranges for the PI34XX family.

Device	Output Voltage	
	Set	Range
PI3420-LGIZ	1.0V	1.0 to 1.4V
PI3421-LGIZ	1.8V	1.4 to 2.0V
PI3422-LGIZ	2.5V	2.0 to 3.1V
PI3423-LGIZ	3.3V	2.3 to 4.1V
PI3424-LGIZ	5.0V	3.3 to 6.5V

Table 2 - PI34XX family output voltage ranges.

Output Current Limit Protection

PI34XX has two methods implemented to protect from output short or over current condition.

Slow Current Limit protection: prevents the output load from sourcing current higher than the regulator’s maximum rated current. If the output current exceeds the Current Limit (I_{OUT_CL}) for

1024us, a slow current limit fault is initiated and the regulator is shutdown which eliminates output current flow. After Fault Restart Delay (t_{FR_DLY}), a soft-start cycle is initiated. This restart cycle will be repeated indefinitely until the excessive load is removed.

Fast Current Limit protection: PI34XX monitors the regulator inductor current pulse-by-pulse to prevent the output from supplying very high current due to sudden low impedance short (50A Typical). If the regulator senses a high inductor current pulse, it will initiate a fault and stop switching until Fault Restart Delay ends and then initiate a soft-start cycle.

Input Under-Voltage Lockout

If VIN falls below the input Under Voltage Lockout (UVLO) threshold, but remains high enough to power the internal bias supply, the PI34XX will complete the current cycle and stop switching. If VIN recovers within 128 switching cycles, the PI34XX will resume normal operation. If this time limit is exceeded, the system will enter a low power state and initiate a fault. The system will restart once the input voltage is reestablished and after the Fault Restart Delay.

Input Over Voltage Lockout

If VIN exceeds the input Over Voltage Lockout (OVLO) threshold (V_{OVLO}), while the controller is running, the PI34XX will complete the current cycle and stop switching. If VIN recovers within 128 switching cycles, the PI34XX will resume normal operation. Otherwise, the system will set an OVLO fault and enter a low power state. The system will resume operation when the input voltage falls below 98% of the OVLO threshold and after the Fault Restart Delay.

Output Over Voltage Protection

The PI34XX family is equipped with output Over Voltage Protection (OVP) to prevent damage to input voltage sensitive devices. If the output voltage exceeds 20% of its set regulated value, the regulator will complete the current cycle, stop switching and issue an OVP fault. The system will resume operation once the output voltage falls below the OVP threshold and after Fault Restart Delay.

Over Temperature Protection

The internal package temperature is monitored to prevent internal components from reaching their thermal maximum. If the Over Temperature Protection Threshold (OTP) is exceeded (T_{OTP}), the regulator will complete the current switching cycle, enter a low power mode, set a fault flag, and will soft-start when the internal temperature falls below Over-Temperature Restart Hysteresis (T_{OTP_HYS}).

Parallel Operation

PI34XX can be paralleled up to three phases. Paralleling modules can be used to increase the output current capability of a single power rail and reduce output voltage ripple.

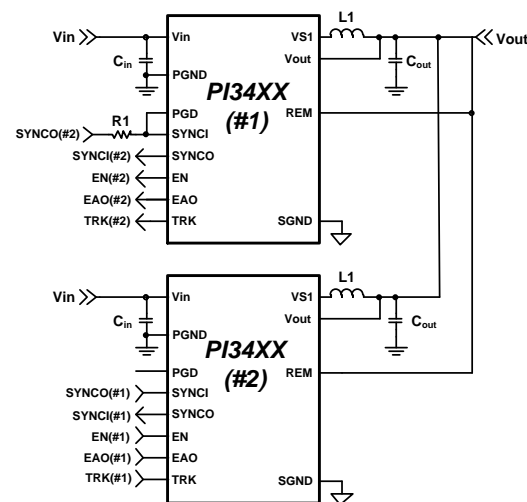

Figure 3 - PI34XX parallel operation

By connecting the EAO pins and SGND pins of each module together the units will share the current equally. When the TRK pins of each unit are connected together, the units will track each other during soft-start and all unit EN pins have to be released to allow the units to start (See Figure 3). Also, any fault event in any regulator will disable the other regulators. The two regulators will be out of phase with each other reducing output ripple (refer to Switching Frequency Synchronization).

To provide synchronization between regulators over the entire operational frequency range, the Parallel

Good (PGD) pin must be connected to the lead regulator’s (#1) SYNCI pin and a 2.5kΩ Resistor, R1, must be placed between SYNCO (#2) return and the lead regulator’s SYNCI (#1) pin, as shown in Figure 3. In this configuration, at system soft-start, the PGD pin pulls SYNCI low forcing the lead regulator to initialize the open-loop startup synchronization. Once the regulators reach regulation, SYNCI is released and the system is now synchronized in a closed-loop configuration which allows the system to adjust, on the fly, when any of the individual regulators begin to enter variable frequency mode in the loop.

Pulse Skip Mode (PSM)

PI34XX features a PSM to achieve high efficiency at light loads. The regulators are setup to skip pulses if EAO falls below a PSM threshold. Depending on conditions and component values, this may result in single pulses or several consecutive pulses followed by skipped pulses. Skipping cycles significantly reduces gate drive power and improves light load efficiency. The regulator will leave PSM once the EAO rises above the Skip Mode threshold.

Variable Frequency Operation

Each PI34XX is preprogrammed to a base operating frequency, with respect to the power stage inductor (see Table 5), to operate at peak efficiency across line and load variations. At low line and high load applications, the base frequency will decrease to accommodate these extreme operating ranges. By stretching the frequency, the ZVS operation is preserved throughout the total input line voltage range therefore maintaining optimum efficiency.

Application Description

Output Voltage Trim

The PI34XX family of Buck Regulators provides five common output voltages: 1.0V, 1.8V, 2.5V, 3.3V and 5.0V. A post-package trim step is implemented to offset any resistor divider network errors ensuring maximum output accuracy.

Device	Output Voltage	
	Set	Range
PI3420-LGIZ	1.0V	1.0 to 1.4V
PI3421-LGIZ	1.8V	1.4 to 2.0V
PI3422-LGIZ	2.5V	2.0 to 3.1V
PI3423-LGIZ	3.3V	2.3 to 4.1V
PI3424-LGIZ	5.0V	3.3 to 6.5V

Table 3 - PI34XX family output voltage ranges

The remote pin (REM) should always be connected to the VOUT pin to prevent an output voltage offset. Figure 4 shows the internal feedback voltage divider network.

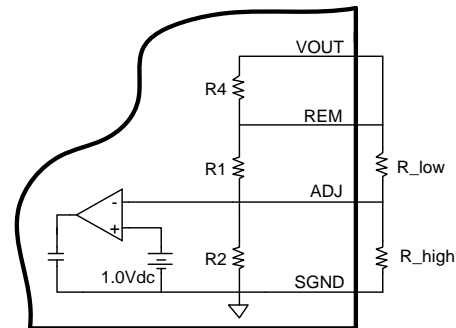

Figure 4 - Internal resistor divider network

R1, R2, and R4 are all internal 1.0 % resistors and R_low and R_high are external resistors for which the designer can add to modify VOUT to a desired output. The internal resistor values for each regulator are listed below in Table 4.

Device	R1	R2	R4
PI3420-LGIZ	1k	∞	100
PI3421-LGIZ	0.806k	1.0k	100
PI3422-LGIZ	1.5k	1.0k	100
PI3423-LGIZ	2.61k	1.13k	100
PI3424-LGIZ	4.53k	1.13k	100

Table 4 - PI34XX Internal divider values

By choosing an output voltage value within the ranges stated in Table 3, VOUT can simply be adjusted up or down by selecting the proper R_high

or R_low value, respectively. The following equations can be used to calculate R_high and R_low values:

$$R_{high} = \frac{1}{\frac{(V_{out} - 1)}{R1} - \left(\frac{1}{R2}\right)} \quad (1)$$

$$R_{low} = \frac{1}{\frac{1}{R2(V_{out} - 1)} - \left(\frac{1}{R1}\right)} \quad (2)$$

If, for example, a 4.0V output is needed, the user should choose the regulator with a trim range covering 4.0V from Table 3. For this example, the PI3423 is selected (3.3V set voltage). First step would be to use Equation (1) to calculate R_high since the required output voltage is higher than the regulator set voltage. The resistor-divider network values for the PI3423 can be found in Table 4 and are R1=2.61kΩ and R2=1.13kΩ. Inserting these values in to Equation (1), R_high is calculated as follows:

$$3.78k = \frac{1}{\frac{(4.0 - 1)}{2.61k} - \left(\frac{1}{1.13k}\right)}$$

Resistor R-high should be connected as shown in Figure 4 to achieve the desired 4.0V regulator output. No external R_low resistor is need in this design example since the trim is above the regulator set voltage.

The PI3420 output voltage can only be trimmed higher than the factory 1V setting. The following equation (3) can be used calculate R_high values for the PI3420 regulators.

$$R_{high(1V)} = \frac{1}{\frac{(V_{out} - 1)}{R1}} \quad (3)$$

Soft-Start Adjust and Tracking

The TRK pin offers a means to increase the regulator’s soft-start time or to track with additional regulators. The soft-start slope is controlled by an internal 100nF and a fixed charge current to provide a minimum startup time of 2.2ms (typical) for all PI34XX regulators. By adding an additional external capacitor to the TRK pin, the soft-start time can be

increased further. The following equation can be used to calculate the proper capacitor for a desired soft-start times:

$$C_{TRK} = (t_{TRK} \times I_{TRK}) - 100 \times 10^{-9},$$

where, t_TRK is the soft-start time and I_TRK is a 50uA internal charge current (see Electrical Characteristics for limits).

There is typically either a proportional or direct tracking method implemented within a tracking design. For proportional tracking between several regulators at startup, simply connect all devices TRK pins together. This type of tracking will force all connected regulators to startup and reach regulation at the same time (see Figure 5 (a)).

For Direct Tracking, choose the regulator with the highest output voltage as the master and connect the master TRK pin to the TRK pin of the other regulators through a divider (Figure 6) with the same ratio as the slave’s feedback divider (see Table 4 for values).

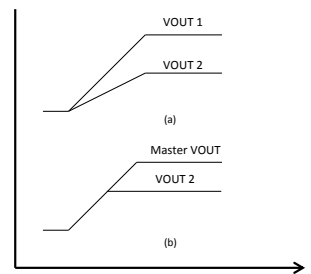

Figure 5 - PI34XX tracking methods

All connected regulators’ soft-start slopes will track with this method. Direct tracking timing is demonstrated in Figure 5 (b).

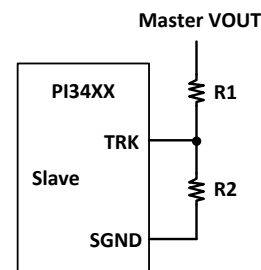

Figure 6 - Voltage divider connections for direct tracking

All tracking regulators should have their Enable (EN) pins connected together to work properly.

Inductor Pairing

The PI34XX utilizes an external inductor. This inductor has been optimized for maximum efficiency performance. Table 5 details the specific inductor value and part number utilized for each PI34XX device and are available through Picor.

Device	Inductor [nH]	Inductor Part Number	Manufacturer
PI3420	80	PI60-02-FPIZ	Picor
PI3421	125	PI60-04-FPIZ	Picor
PI3422	125	PI60-04-FPIZ	Picor
PI3423	150	PI60-05-FPIZ	Picor
PI3424	150	PI60-05-FPIZ	Picor

Table 5 - PI34XX Inductor pairing

Thermal Derating

Thermal de-rating curves are provided that are based on component temperature changes versus load current, input voltage and air flow. It is recommended to use these curves as a guideline for proper thermal de-rating. These curves represent the entire system and are inclusive to both the Picor regulator and the external inductor. Maximum thermal operation is limited by either the MOSFETs or inductor depending upon line and load conditions.

Thermal measurements were made using a standard PI34XX Evaluation board which is 3x4 inches in area and uses 4-layer, 2oz copper. Thermal measurements were made on the three main power devices, the two internal MOSFETs and the external inductor.

Filter Considerations

The PI34XX requires input bulk storage capacitance as well as low impedance ceramic X5R input capacitors to ensure proper start up and high frequency decoupling for the power stage. The PI34XX will draw nearly all of the high frequency current from the low impedance ceramic capacitors when the main high side MOSFET is conducting. During the time the high side MOSFET is off, they are replenished from the bulk capacitor. If the input impedance is high at the switching frequency of the regulator, the bulk capacitor must supply all of the average current into the regulator, including replenishing the ceramic capacitors. This value has been chosen to be 100 μ F so that the PI34XX can

start up into a full resistive load and supply the output capacitive load with the default minimum soft start capacitor when the input source impedance is 50 Ohms at 1MHz. The ESR for this capacitor should be approximately 20m Ω . The RMS ripple current in this capacitor is small, so it should not be a concern if the input recommended ceramic capacitors are used. Table 6 shows the recommended input and output capacitors to be used for the various models as well as expected transient response, RMS ripple currents per capacitor, and input and output ripple voltages. Table 7 includes the recommended input and output ceramic capacitors.

Device	V _{IN} (V)	I _{LOAD} (A)	C _{INPUT} Bulk Elec.	C _{INPUT} Ceramic X5R	C _{OUTPUT} Ceramic X5R	C _{INPUT} Ripple Current (I _{RMS})	C _{OUTPUT} Ripple Current (I _{RMS})	Input Ripple (mVpp)	Output Ripple (mVpp)	Transient Deviation (mVpk)	Recovery Time (μ s)	Load Step (A) (Slew/ μ s)
PI3420	12	15	100 μ F 50V	6X22 μ F	8X100 μ F 2X1 μ F 1X0.1 μ F	0.85	1.24	98	36	-/+41	42	7.5 (5A/ μ s)
		43						27				
PI3421	12	15	100 μ F 50V	6X22 μ F	8X100 μ F 2X1 μ F 1X0.1 μ F	1.0	1.18	139	32	-/+50	50	7.5 (5A/ μ s)
		45						20.4				
PI3422	12	15	100 μ F 50V	6X22 μ F	8X100 μ F 2X1 μ F 1X0.1 μ F	1.12	1.16	145	28	-/+46	60	7.5 (5A/ μ s)
		74						14				
PI3423	12	15	100 μ F 50V	6X22 μ F	8X100 μ F 2X1 μ F 1X0.1 μ F	1.20	1.15	179	26	-/+73	70	7.5 (5A/ μ s)
		97						17				
PI3424	12	15	100 μ F 50V	6X22 μ F	8X47 μ F 2X1 μ F 1X0.1 μ F	1.29	1.13	209	34	-/+98	60	7.5 (5A/ μ s)
		98						24.8				

Table 6 - Recommended input and output capacitance

MURATA PART NUMBER	DESCRIPTION
GRM188R71C105KA12D	1 μ F 16V 0603 X7R
GRM319R71H104KA01D	0.1 μ F 50V 1206 X7R
GRM31CR60J107ME39L	100 μ F 6.3V 1206 X5R
GRM31CR61A476ME15L	47 μ F 10V 1206 X5R
GRM31CR61E226KE15L	22 μ F 25V 1206 X5R

Table 7 - Capacitor manufacturer part numbers

Layout Guidelines

To achieve maximum efficiency and low noise performance from a PI34XX design, layout considerations are necessary. Reducing trace resistance and minimizing high current loop returns along with proper component placement will contribute to optimal performance.

A typical buck regulator circuit is shown in Figure 7. The potential areas of high parasitic inductance and resistance are the circuit return paths, shown as LR below.

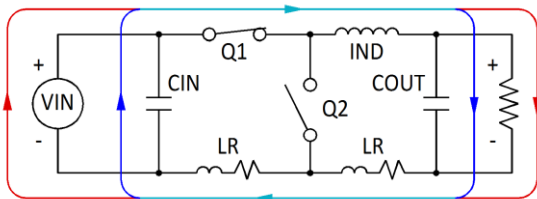

Figure 7 - Typical Buck Regulator

The path between the COUT and CIN capacitors is of particular importance since the AC currents are flowing through both of them when Q1 is turned on. Figure 8, schematically, shows the reduced trace length between input and output capacitors. The shorter path lessens the effects that copper trace parasitics can have on the PI34XX performance.

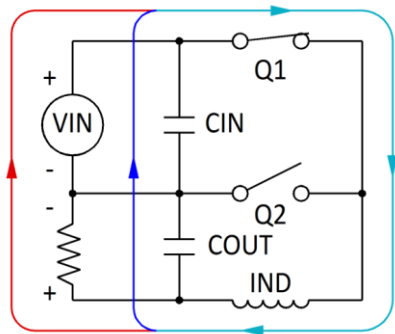

Figure 8 - Current flow: Q1 closed

When Q1 is on and Q2 is off, the majority of CIN's current is used to satisfy the output load and to recharge the COUT capacitors. When Q1 is off and Q2 is on, the load current is supplied by the inductor and the COUT capacitor as shown in Figure 9. During this period CIN is also being recharged by the VIN. Minimizing CIN loop inductance is important to reduce peak voltage excursions when Q1 turns off. Also, the difference in area between the CIN loop and COUT loop is vital to minimize switching and GND noise.

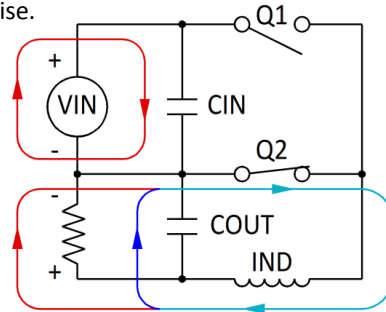

Figure 9 - Current flow: Q2 closed

The recommended component placement, shown in Figure 10, illustrates the tight path between CIN and COUT (and VIN and VOUT) for the high AC return current. This optimized layout is used on the PI34XX evaluation board.

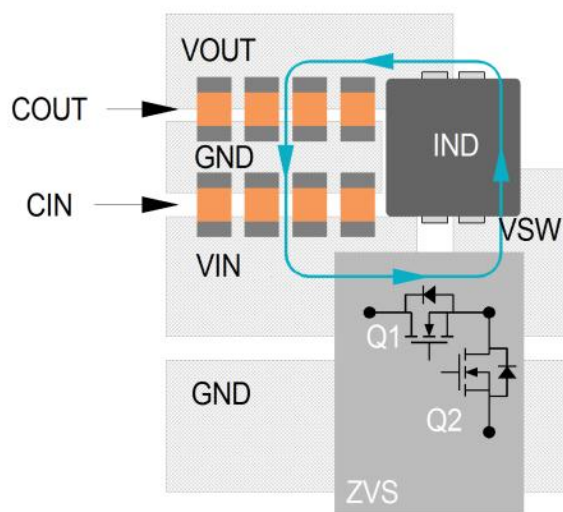

Figure 10 - Recommended component placement and metal routing

Recommended PCB Footprint and Stencil

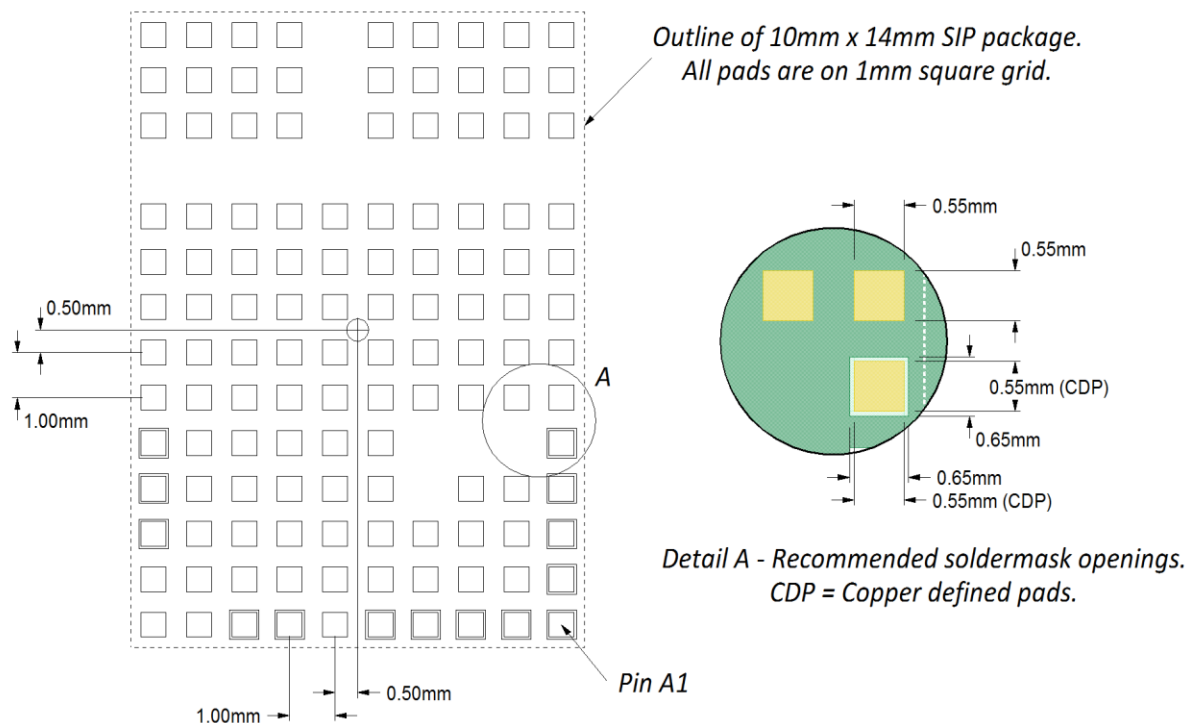
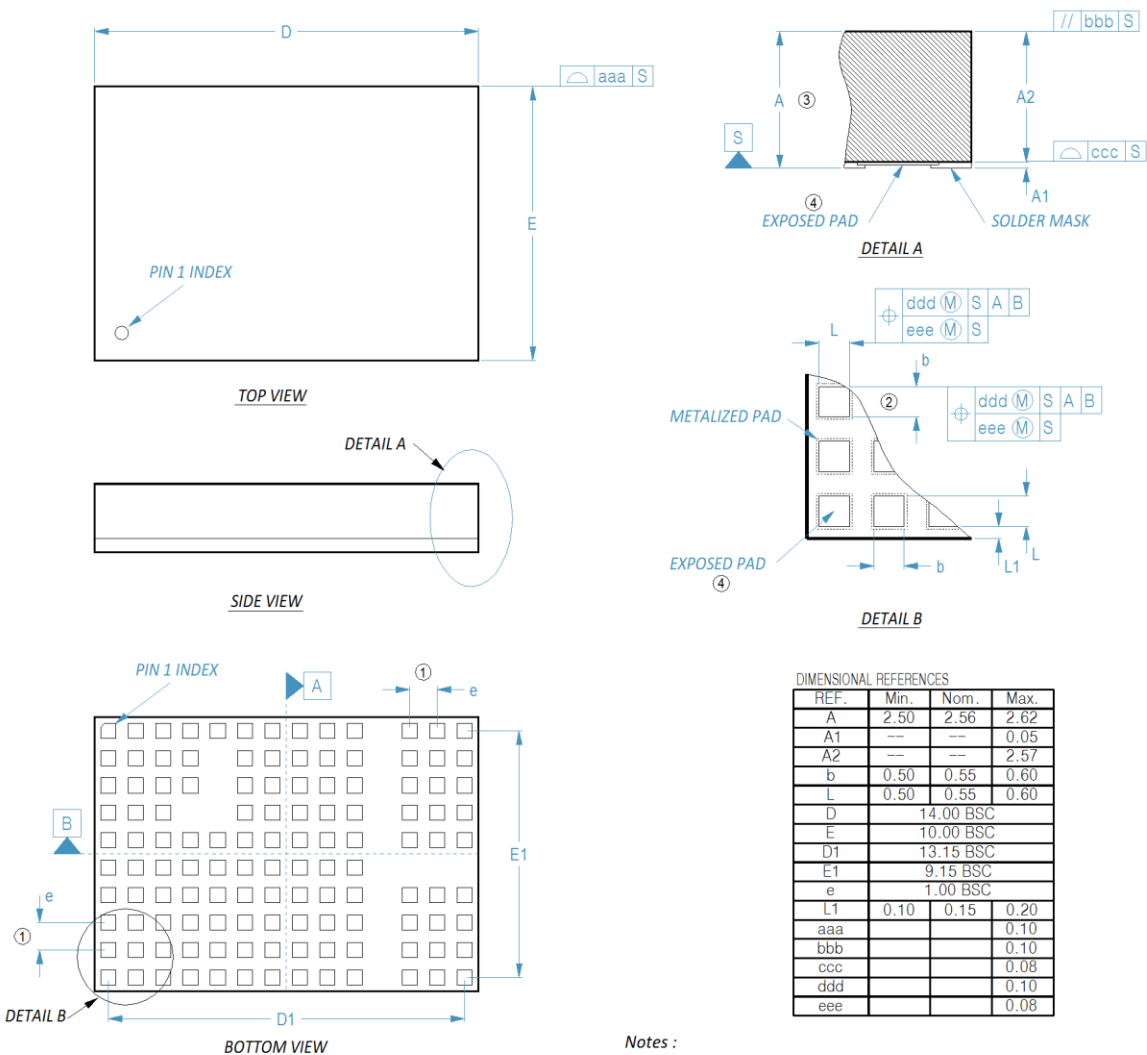

Figure 11- Recommended Receiving PCB footprint.

Figure 11 details the recommended receiving footprint for PI34XX 10mm x 14mm package. All pads should have a final copper size of 0.55mm x 0.55mm, whether they are solder-mask defined or copper defined, on a 1mm x 1mm grid. All stencil openings are 0.55mm when using a 6mil stencil.

Package Drawings



Notes :

- ① 'e' REPRESENTS THE BASIC TERMINAL PITCH. SPECIFIES THE TRUE GEOMETRIC POSITION OF THE TERMINAL AXIS.
- ② DIMENSION 'b' APPLIES TO METALLIZED TERMINAL AND IS MEASURED BETWEEN 0.00mm AND 0.25mm FROM TERMINAL TIP.
- ③ DIMENSION 'A' INCLUDES PACKAGE WARPAGE.
- ④ EXPOSED METALLIZED PADS ARE CU PADS WITH SURFACE FINISH PROTECTION.
5. ALL DIMENSIONS ARE IN MILLIMETERS.

Warranty

Information furnished by Vicor is believed to be accurate and reliable. However, no responsibility is assumed by Vicor for its use. Vicor makes no representations or warranties with respect to the accuracy or completeness of the contents of this publication. Vicor reserves the right to make changes to any products, specifications, and product descriptions at any time without notice. Information published by Vicor has been checked and is believed to be accurate at the time it was printed; however, Vicor assumes no responsibility for inaccuracies. Testing and other quality controls are used to the extent Vicor deems necessary to support Vicor's product warranty. Except where mandated by government requirements, testing of all parameters of each product is not necessarily performed.

Specifications are subject to change without notice.

Vicor's Standard Terms and Conditions

All sales are subject to Vicor's Standard Terms and Conditions of Sale, which are available on Vicor's webpage or upon request.

Product Warranty

In Vicor's standard terms and conditions of sale, Vicor warrants that its products are free from non-conformity to its Standard Specifications (the "Express Limited Warranty"). This warranty is extended only to the original Buyer for the period expiring two (2) years after the date of shipment and is not transferable.

UNLESS OTHERWISE EXPRESSLY STATED IN A WRITTEN SALES AGREEMENT SIGNED BY A DULY AUTHORIZED VICOR SIGNATORY, VICOR DISCLAIMS ALL REPRESENTATIONS, LIABILITIES, AND WARRANTIES OF ANY KIND (WHETHER ARISING BY IMPLICATION OR BY OPERATION OF LAW) WITH RESPECT TO THE PRODUCTS, INCLUDING, WITHOUT LIMITATION, ANY WARRANTIES OR REPRESENTATIONS AS TO MERCHANTABILITY, FITNESS FOR PARTICULAR PURPOSE, INFRINGEMENT OF ANY PATENT, COPYRIGHT, OR OTHER INTELLECTUAL PROPERTY RIGHT, OR ANY OTHER MATTER.

This warranty does not extend to products subjected to misuse, accident, or improper application, maintenance, or storage. Vicor shall not be liable for collateral or consequential damage. Vicor disclaims any and all liability arising out of the application or use of any product or circuit and assumes no liability for applications assistance or buyer product design. Buyers are responsible for their products and applications using Vicor products and components. Prior to using or distributing any products that include Vicor components, buyers should provide adequate design, testing and operating safeguards.

Vicor will repair or replace defective products in accordance with its own best judgment. For service under this warranty, the buyer must contact Vicor to obtain a Return Material Authorization (RMA) number and shipping instructions. Products returned without prior authorization will be returned to the buyer. The buyer will pay all charges incurred in returning the product to the factory. Vicor will pay all reshipment charges if the product was defective within the terms of this warranty.

Life Support Policy

VICOR'S PRODUCTS ARE NOT AUTHORIZED FOR USE AS CRITICAL COMPONENTS IN LIFE SUPPORT DEVICES OR SYSTEMS WITHOUT THE EXPRESS PRIOR WRITTEN APPROVAL OF THE CHIEF EXECUTIVE OFFICER AND GENERAL COUNSEL OF VICOR CORPORATION. As used herein, life support devices or systems are devices which (a) are intended for surgical implant into the body, or (b) support or sustain life and whose failure to perform when properly used in accordance with instructions for use provided in the labeling can be reasonably expected to result in a significant injury to the user. A critical component is any component in a life support device or system whose failure to perform can be reasonably expected to cause the failure of the life support device or system or to affect its safety or effectiveness. Per Vicor Terms and Conditions of Sale, the user of Vicor products and components in life support applications assumes all risks of such use and indemnifies Vicor against all liability and damages.

Intellectual Property Notice

Vicor and its subsidiaries own Intellectual Property (including issued U.S. and Foreign Patents and pending patent applications) relating to the products described in this data sheet. No license, whether express, implied, or arising by estoppel or otherwise, to any intellectual property rights is granted by this document. Interested parties should contact Vicor's Intellectual Property Department.

The products described on this data sheet are protected by the following U.S. Patents Numbers: RE 40,072.

Vicor Corporation
25 Frontage Road
Andover, MA, USA 01810 USA

Picor Corporation
51 Industrial Drive
North Smithfield, RI 02896 USA

Customer Service: custserv@vicorpower.com

Technical Support: apps@vicorpower.com

Компания «Океан Электроники» предлагает заключение долгосрочных отношений при поставках импортных электронных компонентов на взаимовыгодных условиях!

Наши преимущества:

- Поставка оригинальных импортных электронных компонентов напрямую с производств Америки, Европы и Азии, а так же с крупнейших складов мира;
- Широкая линейка поставок активных и пассивных импортных электронных компонентов (более 30 млн. наименований);
- Поставка сложных, дефицитных, либо снятых с производства позиций;
- Оперативные сроки поставки под заказ (от 5 рабочих дней);
- Экспресс доставка в любую точку России;
- Помощь Конструкторского Отдела и консультации квалифицированных инженеров;
- Техническая поддержка проекта, помощь в подборе аналогов, поставка прототипов;
- Поставка электронных компонентов под контролем ВП;
- Система менеджмента качества сертифицирована по Международному стандарту ISO 9001;
- При необходимости вся продукция военного и аэрокосмического назначения проходит испытания и сертификацию в лаборатории (по согласованию с заказчиком);
- Поставка специализированных компонентов военного и аэрокосмического уровня качества (Xilinx, Altera, Analog Devices, Intersil, Interpoint, Microsemi, Actel, Aeroflex, Peregrine, VPT, Syfer, Eurofarad, Texas Instruments, MS Kennedy, Miteq, Cobham, E2V, MA-COM, Hittite, Mini-Circuits, General Dynamics и др.);

Компания «Океан Электроники» является официальным дистрибьютором и эксклюзивным представителем в России одного из крупнейших производителей разъемов военного и аэрокосмического назначения «JONHON», а так же официальным дистрибьютором и эксклюзивным представителем в России производителя высокотехнологичных и надежных решений для передачи СВЧ сигналов «FORSTAR».



JONHON

«JONHON» (основан в 1970 г.)

Разъемы специального, военного и аэрокосмического назначения:

(Применяются в военной, авиационной, аэрокосмической, морской, железнодорожной, горно- и нефтедобывающей отраслях промышленности)

«FORSTAR» (основан в 1998 г.)

ВЧ соединители, коаксиальные кабели, кабельные сборки и микроволновые компоненты:

(Применяются в телекоммуникациях гражданского и специального назначения, в средствах связи, РЛС, а так же военной, авиационной и аэрокосмической отраслях промышленности).



Телефон: 8 (812) 309-75-97 (многоканальный)

Факс: 8 (812) 320-03-32

Электронная почта: ocean@oceanchips.ru

Web: <http://oceanchips.ru/>

Адрес: 198099, г. Санкт-Петербург, ул. Калинина, д. 2, корп. 4, лит. А