



14 Gbps, 2:1 SELECTOR w/ PROGRAMMABLE OUTPUT VOLTAGE & POSITIVE SUPPLY

Typical Applications

The HMC748LC3C is ideal for:

- 2:1 Multiplexer up to 14 Gbps
- RF ATE Applications
- Broadband Test & Measurement
- Serial Data Transmission up to 14 Gbps
- Redundant Path Switching
- Built-in Test

Features

- Supports High Data Rates: up to 14 Gbps
- Single-ended inputs
- Differential & Single-Ended Outputs
- Fast Rise and Fall Times: 22 / 22 ps
- Low Power Consumption: 250 mW typ.
- Programmable Differential Output Voltage Swing: 600 - 1200 mV
- Propagation Delay: 125 ps
- Single Supply: +3.3 V
- 16 Lead Ceramic 3x3 mm SMT Package: 9 mm²

Functional Diagram

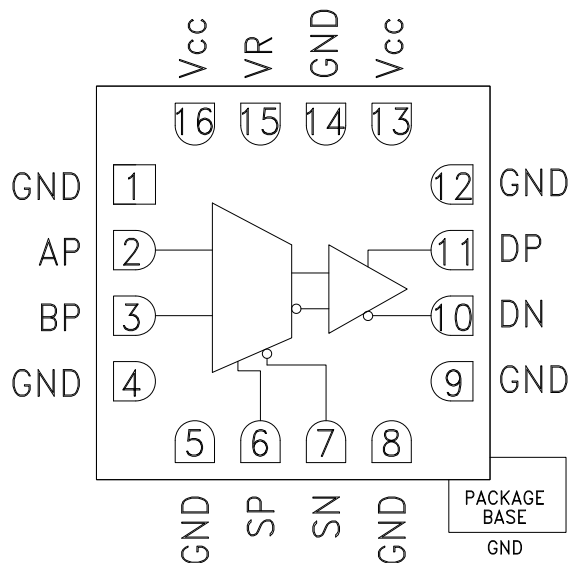

General Description

The HMC748LC3C is a 2:1 Selector designed to support data transmission rates of up to 14 Gbps, and selector port operation of up to 14 GHz. The selector routes one of the two single-ended inputs to the differential output upon assertion of the proper select port. The HMC748LC3C also features an output level control pin, VR, that allows for loss compensation or for signal level optimization.

All select differential inputs to the HMC748LC3C are CML and terminated on-chip with 50 ohms to the positive supply, Vcc, and may be AC or DC coupled. The single-ended inputs to the HMC748LC3C are CML terminated on-chip with 50 ohms to the positive supply, GND, and may be DC coupled. The differential CML outputs are source terminated to 50 ohms and may also be AC or DC coupled. Outputs can be connected directly to a 50 ohm Vcc terminated system, while DC blocking capacitors may be used if the terminating system is 50 ohms to ground. The HMC748LC3C operates from a single + 3.3 V supply and is available in ROHS-compliant 3x3 mm SMT package.

Electrical Specifications, $T_A = +25^\circ\text{C}$, $V_{CC} = 3.3\text{ V}$, $V_R = 3.3\text{ V}$

Parameter	Conditions	Min.	Typ.	Max	Units
Power Supply Voltage		3.0	3.3	3.6	V
Power Supply Current			76		mA
Maximum Data Rate			14		Gbps
Maximum Select Rate			14		GHz
Maximum Serial Transmission Rate			26		Gbps

Information furnished by Analog Devices is believed to be accurate and reliable. However, no responsibility is assumed by Analog Devices for its use, nor for any infringements of patents or other rights of third parties that may result from its use. Specifications subject to change without notice. No license is granted by implication or otherwise under any patent or patent rights of Analog Devices. Trademarks and registered trademarks are the property of their respective owners.

For price, delivery, and to place orders: Analog Devices, Inc., One Technology Way, P.O. Box 9106, Norwood, MA 02062-9106
Phone: 781-329-4700 • Order online at www.analog.com
Application Support: Phone: 1-800-ANALOG-D

14 Gbps, 2:1 SELECTOR w/ PROGRAMMABLE OUTPUT VOLTAGE & POSITIVE SUPPLY



Electrical Specifications (continued)

Parameter	Conditions	Min.	Typ.	Max	Units
Input Vcm	Vin = 600 mVp-p	Vcc - 0.375	Vcc - 0.300	Vcc - 0.275	V
Input High Voltage			Vcc - 0.1	Vcc - 0.5	V
Input Low Voltage		Vcc - 0.1	Vcc - 0.5		V
Input Return Loss	Frequency <14 GHz		10		dB
Output Amplitude	Single-Ended, peak-to-peak		550		mVp-p
	Differential, peak-to-peak		1100		mVp-p
Output High Voltage			3.29		V
Output Low Voltage			2.74		V
Output Rise / Fall Time	Differential, 20% - 80%		22 / 22		ps
Output Return Loss	Frequency <13 GHz		10		dB
Random Jitter, Jr	rms ^[1]			0.2	ps rms
Deterministic Jitter, Jd	peak-to-peak, 2 ¹⁵ -1 PRBS input ^[2]		2		ps, p-p
Propagation Delay, A or B to D _{OUT} , td			125		ps
Propagation Delay Select to Data, tds			135		ps
Set Up & Hold Time, t _{SH}			6		ps
VR Pin Current	VR = 3.3 V		2		mA
VR Pin Current	VR = 3.7 V			3.5	mA

[1] Upper limit of random jitter, Jr, determined by measuring and integrating output phase noise with a sinusoidal input at 5, 10, and 13.5 GHz over temperature

[2] Deterministic jitter calculated by simultaneously measuring the jitter of a 200 mV, 12.5 GHz, 2¹⁵-1 PRBS input, and a single-ended output

DC Current vs. Supply Voltage ^[1] ^[2]

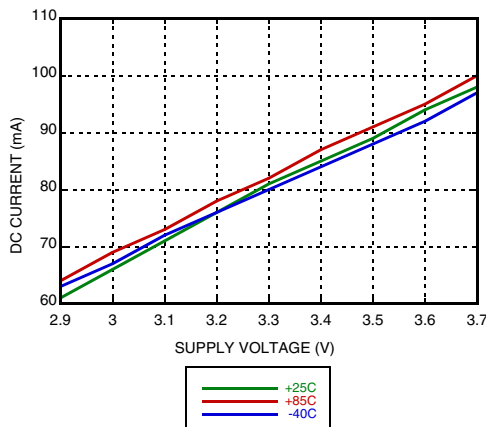

Output Differential Voltage vs. Supply Voltage ^[1] ^[2]

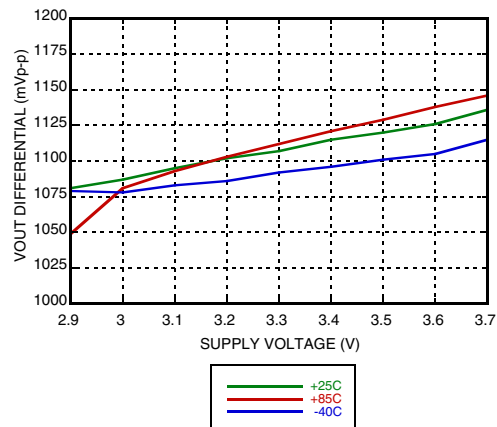

[1] VR = 3.3 V

[2] Frequency = 13 GHz

[3] Vcc = 3.3 V



14 Gbps, 2:1 SELECTOR w/ PROGRAMMABLE OUTPUT VOLTAGE & POSITIVE SUPPLY

Rise / Fall Time vs. Supply Voltage [1] [2]

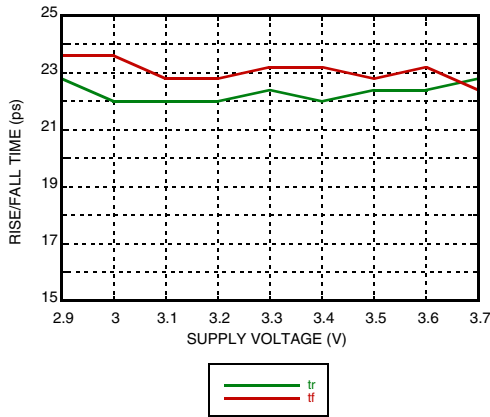

Output Differential vs. Frequency [1] [3]

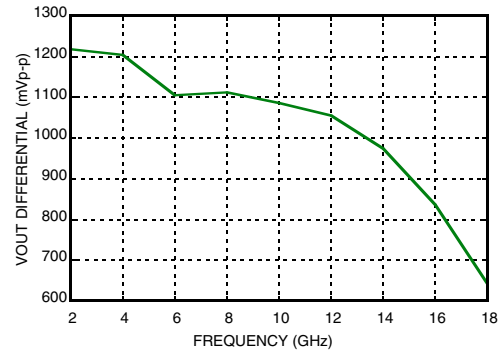

Output Differential Voltage vs. VR [1] [2]

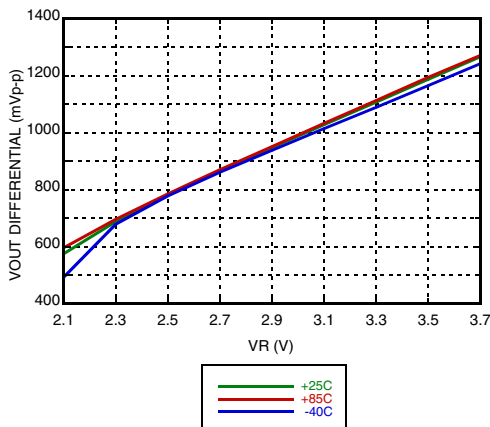

Rise / Fall Time vs. VR [1] [2]

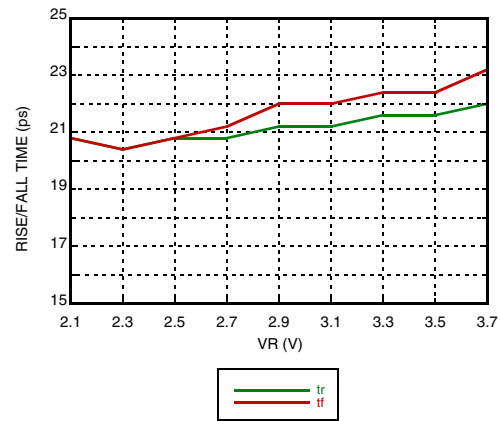

Input Return Loss vs. Frequency

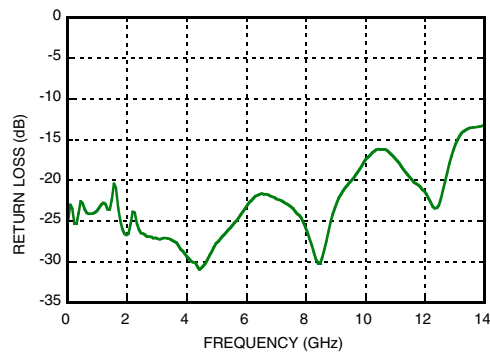

Output Return Loss vs. Frequency

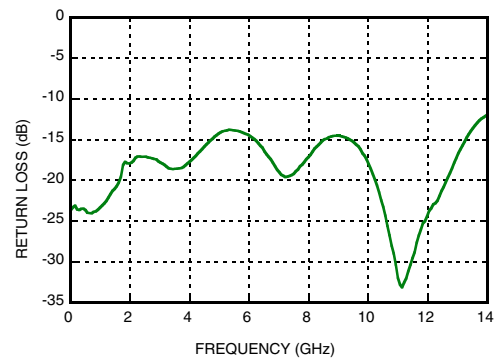

[1] Vcc = 3.3 V

[2] Frequency = 13 GHz

[3] Vcc = 3.3 V

Information furnished by Analog Devices is believed to be accurate and reliable. However, no responsibility is assumed by Analog Devices for its use, nor for any infringements of patents or other rights of third parties that may result from its use. Specifications subject to change without notice. No license is granted by implication or otherwise under any patent or patent rights of Analog Devices. Trademarks and registered trademarks are the property of their respective owners.

For price, delivery, and to place orders: Analog Devices, Inc., One Technology Way, P.O. Box 9106, Norwood, MA 02062-9106 Phone: 781-329-4700 • Order online at www.analog.com Application Support: Phone: 1-800-ANALOG-D

**14 Gbps, 2:1 SELECTOR w/ PROGRAMMABLE
OUTPUT VOLTAGE & POSITIVE SUPPLY**



Select Port Return Loss vs. Frequency

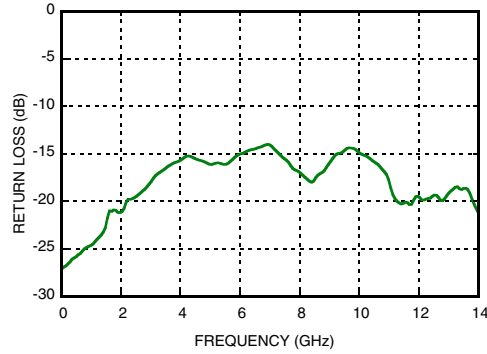

Eye Diagram

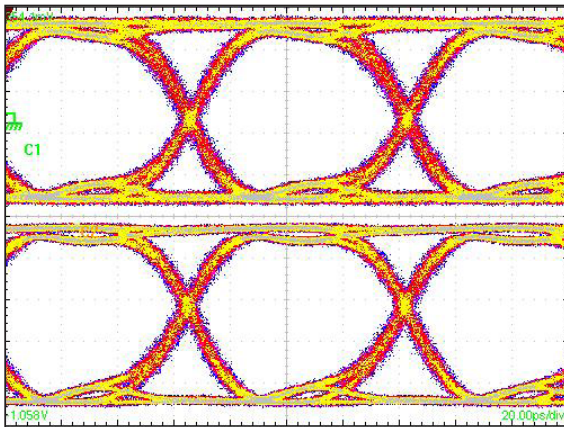

[1] Test Conditions:
Waveform generated with an Agilent N4903A J-Bert.
Rate = 13 GHz
Eye Diagram data presented on a Tektronix CSA 8000
Device is AC coupled to scope.

Timing Diagram

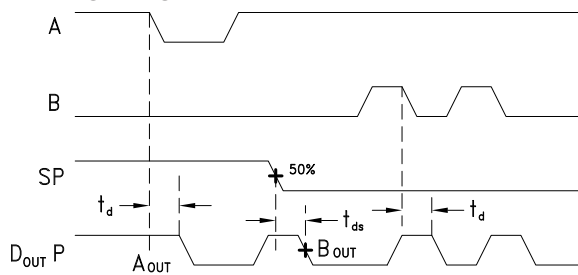

t_d = propagation delay, A or B to Dout
 t_{ds} = propagation delay, Select to Dout

Truth Table

Inputs	Outputs
S	DP
H	A -> D
L	B -> D

H - Positive voltage level
L - Negative voltage level

Notes:
D = DP - DN
S = SP - SN



14 Gbps, 2:1 SELECTOR w/ PROGRAMMABLE OUTPUT VOLTAGE & POSITIVE SUPPLY

Absolute Maximum Ratings

Power Supply Voltage (Vcc)	Vcc -0.5 V to 3.75 V
Input Signals	Vcc - 2.0 V to Vcc + 0.5 V
Output Signals	Vcc - 1.5 V to Vcc + 0.5 V
Continuous Pdiss (T = 85 °C) (derate 17 mW/°C above 85 °C)	0.68 W
Thermal Resistance (R _{th j-p})worst case junction to package paddle	59 °C/W
Maximum Junction Temperature	125 °C
Storage Temperature	-65 °C to +150 °C
Operating Temperature	-40 °C to +85 °C
ESD Sensitivity (HBM)	Class 1B



ELECTROSTATIC SENSITIVE DEVICE
OBSERVE HANDLING PRECAUTIONS

Outline Drawing

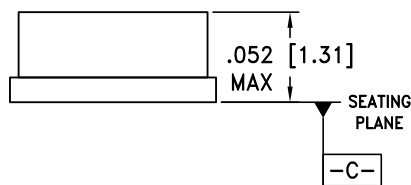
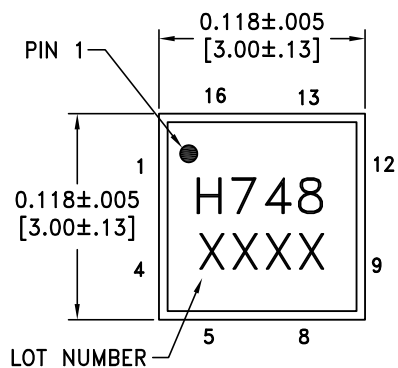

BOTTOM VIEW

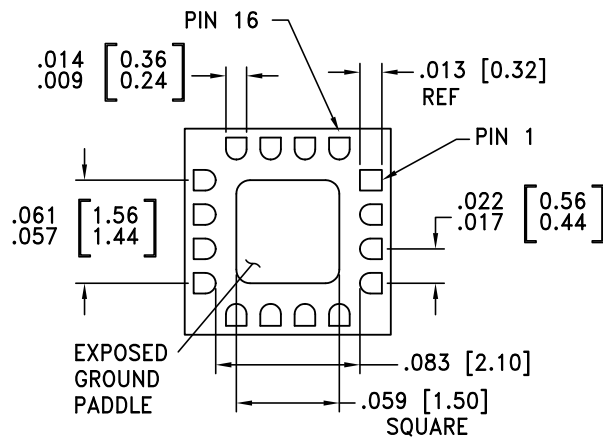

NOTES:

1. PACKAGE BODY MATERIAL: ALUMINA
2. LEAD AND GROUND PADDLE PLATING:
30-80 MICROINCHES GOLD OVER 50 MICROINCHES MINIMUM NICKEL.
3. DIMENSIONS ARE IN INCHES [MILLIMETERS].
4. LEAD SPACING TOLERANCE IS NON-CUMULATIVE.
5. PACKAGE WARP SHALL NOT EXCEED 0.05 mm DATUM -C-
6. ALL GROUND LEADS MUST BE SOLDERED TO PCB RF GROUND.
7. PADDLE MUST BE SOLDERED TO GND.

Package Information

Part Number	Package Body Material	Lead Finish	MSL Rating	Package Marking ^[2]
HMC748LC3C	Alumina, White	Gold over Nickel	MSL3 ^[1]	H748 XXXX



[1] Max peak reflow temperature of 260 °C

[2] 4-Digit lot number XXXX

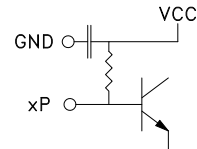
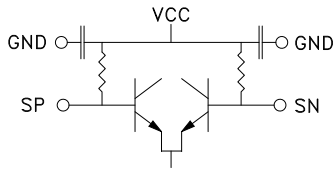
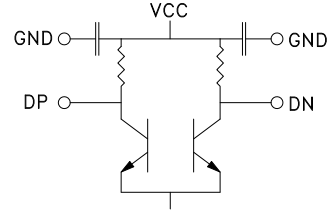

14 Gbps, 2:1 SELECTOR w/ PROGRAMMABLE OUTPUT VOLTAGE & POSITIVE SUPPLY

Pin Descriptions

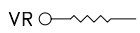
Pin Number	Function	Description	Interface Schematic
1, 4, 5, 8, 9, 12	GND	Signal Grounds	
2, 3	AP, BP	Single-Ended Data Inputs: Current Mode Logic (CML) referenced to positive supply.	
6, 7	SP, SN	Differential Select Inputs: Current Mode Logic (CML) referenced to positive supply.	
10, 11	DN, DP	Differential Data Outputs: Current Mode Logic (CML) referenced to positive supply.	
13, 16	Vcc	Positive Supply	
14, Package Base	GND	Supply Ground	
15	VR	Output level control. Output level may be adjusted by applying a voltage to VR per "Output Differential vs. VR" plot.	



**14 Gbps, 2:1 SELECTOR w/ PROGRAMMABLE
OUTPUT VOLTAGE & POSITIVE SUPPLY**

Evaluation PCB

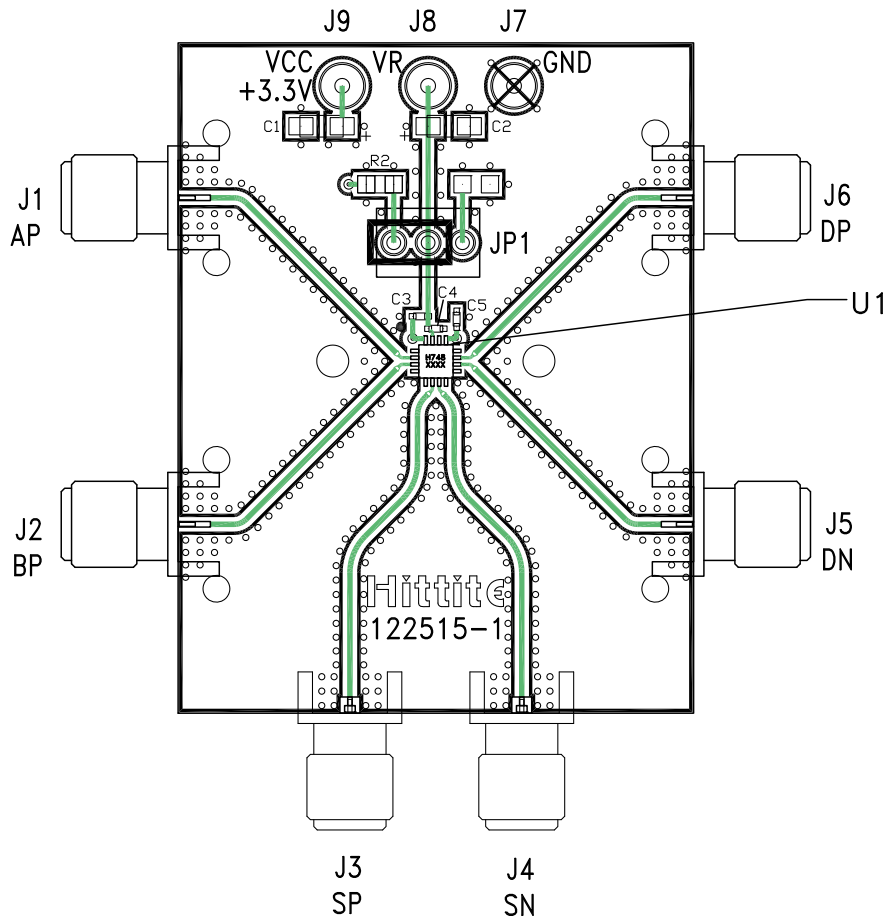

List of Materials for Evaluation PCB 122517 [1]

Item	Description
J1 - J6	PCB Mount SMA RF Connectors
J7 - J9	DC Pin
JP1	Shorting Jumper
C1, C2	4.7 μF Capacitor, Tantalum
C3 - C5	100 pF Capacitor, 0402 Pkg.
R2	10 Ohm Resistor, 0603 Pkg.
U1	HMC748LC3C High Speed Logic, 2:1 Selector
PCB [2]	122515 Evaluation Board

[1] Reference this number when ordering complete evaluation PCB

[2] Circuit Board Material: Arlon 25FR or Rogers 4350

The circuit board used in the application should use RF circuit design techniques. Signal lines should have 50 ohm impedance while the package ground leads should be connected directly to the ground plane similar to that shown. The exposed package base should be connected to GND. A sufficient number of via holes should be used to connect the top and bottom ground planes. The evaluation circuit board shown is available from Hittite upon request. Install jumper on JP1 to short VR to Vcc for normal operation.

**14 Gbps, 2:1 SELECTOR w/ PROGRAMMABLE
OUTPUT VOLTAGE & POSITIVE SUPPLY**



Application Circuit

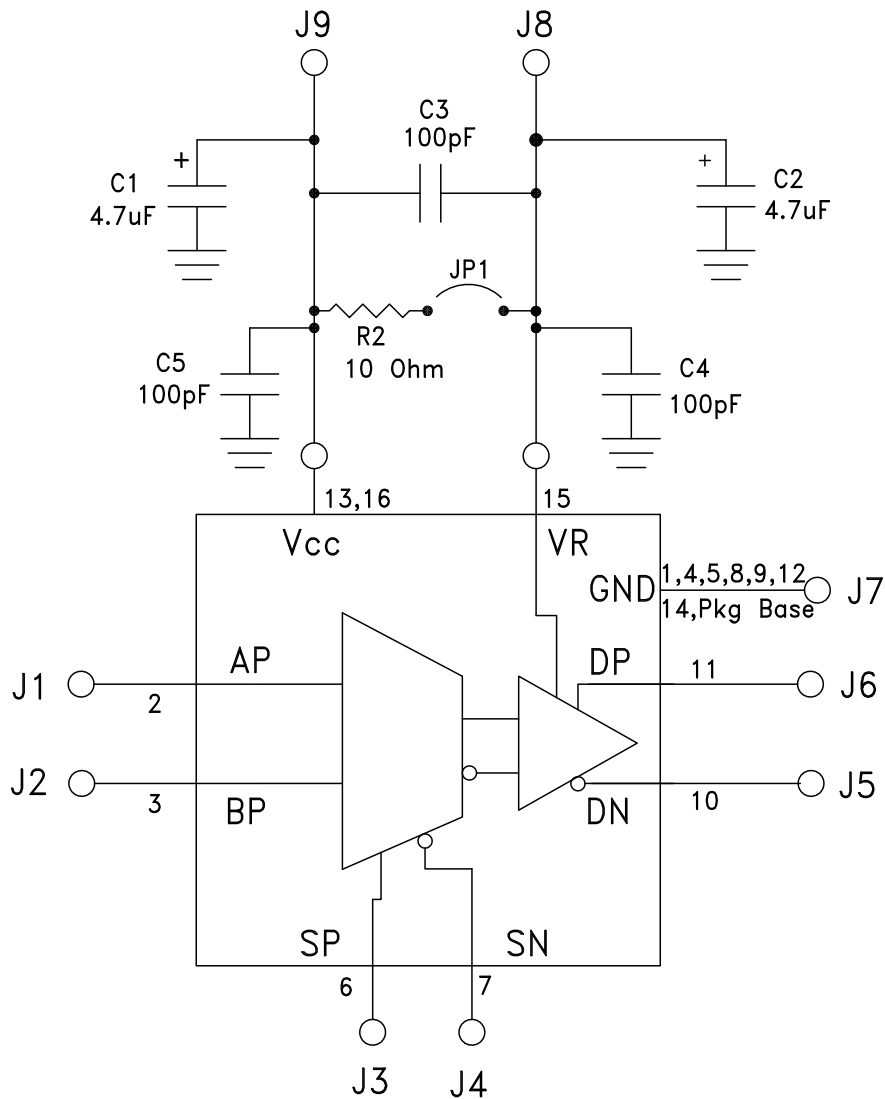

Компания «Океан Электроники» предлагает заключение долгосрочных отношений при поставках импортных электронных компонентов на взаимовыгодных условиях!

Наши преимущества:

- Поставка оригинальных импортных электронных компонентов напрямую с производств Америки, Европы и Азии, а так же с крупнейших складов мира;
- Широкая линейка поставок активных и пассивных импортных электронных компонентов (более 30 млн. наименований);
- Поставка сложных, дефицитных, либо снятых с производства позиций;
- Оперативные сроки поставки под заказ (от 5 рабочих дней);
- Экспресс доставка в любую точку России;
- Помощь Конструкторского Отдела и консультации квалифицированных инженеров;
- Техническая поддержка проекта, помощь в подборе аналогов, поставка прототипов;
- Поставка электронных компонентов под контролем ВП;
- Система менеджмента качества сертифицирована по Международному стандарту ISO 9001;
- При необходимости вся продукция военного и аэрокосмического назначения проходит испытания и сертификацию в лаборатории (по согласованию с заказчиком);
- Поставка специализированных компонентов военного и аэрокосмического уровня качества (Xilinx, Altera, Analog Devices, Intersil, Interpoint, Microsemi, Actel, Aeroflex, Peregrine, VPT, Syfer, Eurofarad, Texas Instruments, MS Kennedy, Miteq, Cobham, E2V, MA-COM, Hittite, Mini-Circuits, General Dynamics и др.);

Компания «Океан Электроники» является официальным дистрибьютором и эксклюзивным представителем в России одного из крупнейших производителей разъемов военного и аэрокосмического назначения «JONHON», а так же официальным дистрибьютором и эксклюзивным представителем в России производителя высокотехнологичных и надежных решений для передачи СВЧ сигналов «FORSTAR».



JONHON

«JONHON» (основан в 1970 г.)

Разъемы специального, военного и аэрокосмического назначения:

(Применяются в военной, авиационной, аэрокосмической, морской, железнодорожной, горно- и нефтедобывающей отраслях промышленности)

«FORSTAR» (основан в 1998 г.)

ВЧ соединители, коаксиальные кабели, кабельные сборки и микроволновые компоненты:

(Применяются в телекоммуникациях гражданского и специального назначения, в средствах связи, РЛС, а так же военной, авиационной и аэрокосмической отраслях промышленности).



Телефон: 8 (812) 309-75-97 (многоканальный)

Факс: 8 (812) 320-03-32

Электронная почта: ocean@oceanchips.ru

Web: <http://oceanchips.ru/>

Адрес: 198099, г. Санкт-Петербург, ул. Калинина, д. 2, корп. 4, лит. А