

## Standalone Linear Li-Ion Battery Charger with Thermal Regulation in DFN

### FEATURES

- Programmable Charge Current Up to 950mA
- Complete Linear Charger in DFN Package
- No MOSFET, Sense Resistor or Blocking Diode Required
- Thermal Regulation Maximizes Charge Rate Without Risk of Overheating\*
- Battery Kelvin Sensing Improves Charging Accuracy
- Charges Directly from a USB Port
- C/10 Charge Termination
- Preset 4.2V Charge Voltage with  $\pm 1\%$  Accuracy
- Charge Current Monitor Output for Gas Gauging\*
- Automatic Recharge
- Charge Status Output
- "AC Present" Output
- 2.9V Trickle Charge Threshold (LTC4058)
- Available Without Trickle Charge (LTC4058X)
- Soft-Start Limits Inrush Current
- Low Profile (3mm  $\times$  3mm  $\times$  0.75mm) DFN Package

### APPLICATIONS

- Cellular Telephones, PDAs, MP3 Players
- Bluetooth Applications

### DESCRIPTION

The LTC<sup>®</sup>4058 is a complete constant-current/constant-voltage linear charger for single cell lithium-ion batteries. Its DFN package and low external component count make the LTC4058 ideally suited for portable applications. Furthermore, the LTC4058 is designed to work within USB power specifications.

The LTC4058 can Kelvin sense the battery terminal for more accurate float voltage charging. No external sense resistor or external blocking diode are required due to the internal MOSFET architecture. Thermal feedback regulates the charge current to limit the die temperature during high power operation or high ambient temperature conditions. The charge voltage is fixed at 4.2V and the charge current is programmed with a resistor. The LTC4058 terminates the charge cycle when the charge current drops to 10% of the programmed value after the final float voltage is reached.

When the input supply (wall adapter or USB supply) is removed, the LTC4058 enters a low current state dropping the battery drain current to less than 2 $\mu$ A. Other features include charge current monitor, undervoltage lockout, automatic recharge and status pins to indicate charge termination and the presence of an input voltage.

LT, LTC and LT are registered trademarks of Linear Technology Corporation.  
 \*US Patent 6,522,118

### TYPICAL APPLICATION

Single Cell Li-Ion Battery Charger with Kelvin Sense

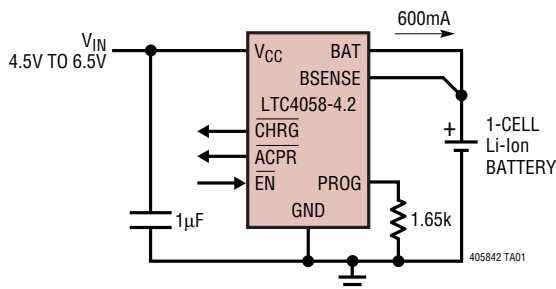

Complete Charge Cycle (750mAh Battery)

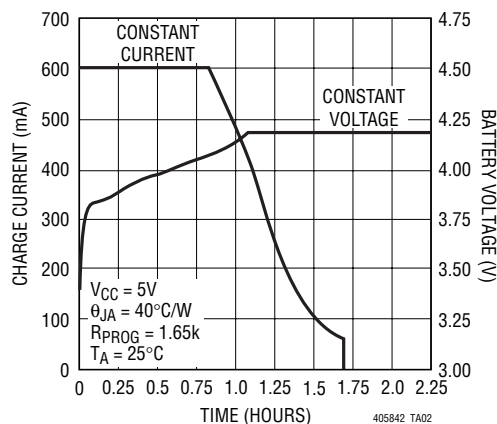

sn405842 405842fs

## ABSOLUTE MAXIMUM RATINGS

(Note 1)

Input Supply Voltage ( $V_{CC}$ )	-0.3V to 10V
PROG	-0.3V to $V_{CC} + 0.3V$
BAT, $BSENSE$	-0.3V to 7V
CHRG, $ACPR$ , $\overline{EN}$	-0.3V to 10V
BAT Short-Circuit Duration	Continuous
BAT Pin Current	1A
PROG Pin Current	1mA
Maximum Junction Temperature	125°C
Operating Temperature Range (Note 2)	-40°C to 85°C
Storage Temperature Range	-65°C to 125°C

## PACKAGE/ORDER INFORMATION

<p>DD PACKAGE 8-LEAD (3mm × 3mm) PLASTIC DFN <math>T_{JMAX} = 125^{\circ}C</math>, <math>\theta_{JA} = 40^{\circ}C/W</math> (NOTE 3) EXPOSED PAD IS GROUND (PIN 9) MUST BE SOLDERED TO PCB</p>	ORDER PART NUMBER
	LTC4058EDD-4.2 LTC4058XEDD-4.2
	DD PART MARKING
	LAEV LBDH

Consult LTC Marketing for parts specified with wider operating temperature ranges.

## ELECTRICAL CHARACTERISTICS

The ● denotes specifications which apply over the full operating temperature range, otherwise specifications are at  $T_A = 25^{\circ}C$ .  $V_{CC} = 5V$ , unless otherwise noted.

SYMBOL	PARAMETER	CONDITIONS	MIN	TYP	MAX	UNITS	
$V_{CC}$	Input Supply Voltage		●	4.25	6.5	V	
$I_{CC}$	Input Supply Current	Charge Mode (Note 4), $R_{PROG} = 10k$ Standby Mode (Charge Terminated) Shutdown Mode ( $\overline{EN} = 5V$ , $V_{CC} < V_{BSENSE}$ or $V_{CC} < V_{UV}$ )	●	0.3	1	mA	
			●	200	500	$\mu A$	
			●	25	50	$\mu A$	
$V_{FLOAT}$	Regulated Output (Float) Voltage	$0^{\circ}C \leq T_A \leq 85^{\circ}C$ , $4.3V < V_{CC} < 6.5V$		4.158	4.2	4.242	V
$I_{BAT}$	BAT Pin Current	$R_{PROG} = 10k$ , Current Mode $R_{PROG} = 2k$ , Current Mode	●	93	100	107	mA
			●	465	500	535	mA
$I_{BSENSE}$	$BSENSE$ Pin Current (Note 5)	Standby Mode, $V_{BSENSE} = 4.2V$ Shutdown Mode ( $\overline{EN} = 5V$ , $V_{CC} < V_{BSENSE}$ or $V_{CC} < V_{UV}$ ) Sleep Mode, $V_{CC} = 0V$	●	-2.5	-6	$\mu A$	
				$\pm 1$	$\pm 2$	$\mu A$	
				$\pm 1$	$\pm 2$	$\mu A$	
$I_{TRIKL}$	Trickle Charge Current	$V_{BSENSE} < V_{TRIKL}$ , $R_{PROG} = 2k$ (Note 6)	●	30	45	60	mA
$V_{TRIKL}$	Trickle Charge Threshold Voltage	$R_{PROG} = 10k$ , $V_{BSENSE}$ Rising (Note 6)		2.8	2.9	3	V
$V_{TRHYS}$	Trickle Charge Hysteresis Voltage	$R_{PROG} = 10k$ (Note 6)		60	80	110	mV
$V_{UV}$	$V_{CC}$ Undervoltage Lockout Voltage	From $V_{CC}$ Low to High	●	3.7	3.8	3.92	V
$V_{UVHYS}$	$V_{CC}$ Undervoltage Lockout Hysteresis		●	150	200	300	mV
$V_{\overline{EN}(IL)}$	$\overline{EN}$ Pin Input Low Voltage		●	0.4	0.7		V
$V_{\overline{EN}(IH)}$	$\overline{EN}$ Pin Input High Voltage		●		0.7	1	V
$R_{\overline{EN}}$	$\overline{EN}$ Pin Pull-Down Resistor		●	1.2	2	5	M $\Omega$
$V_{ASD}$	$V_{CC} - V_{BSENSE}$ Lockout Threshold	$V_{CC}$ from Low to High $V_{CC}$ from High to Low		70	100	140	mV
				5	30	50	mV
$I_{TERM}$	C/10 Termination Current Threshold	$R_{PROG} = 10k$ ( $I_{CHG} = 100mA$ ) (Note 7) $R_{PROG} = 2k$ ( $I_{CHG} = 500mA$ )	●	0.085	0.10	0.115	mA/mA
			●	0.085	0.10	0.115	mA/mA
$V_{PROG}$	PROG Pin Voltage	$R_{PROG} = 10k$ , Current Mode		0.93	1	1.07	V
$V_{CHRG}$	$\overline{CHRG}$ Pin Output Low Voltage	$I_{CHRG} = 5mA$			0.35	0.6	V
$V_{ACPR}$	$\overline{ACPR}$ Pin Output Low Voltage	$I_{ACPR} = 5mA$			0.35	0.6	V
$\Delta V_{RECHRG}$	Recharge Battery Threshold Voltage	$V_{FLOAT} - V_{RECHRG}$ , $0^{\circ}C \leq T_A \leq 85^{\circ}C$		60	100	140	mV

**ELECTRICAL CHARACTERISTICS** The ● denotes specifications which apply over the full operating temperature range, otherwise specifications are at  $T_A = 25^\circ\text{C}$ .  $V_{CC} = 5\text{V}$ , unless otherwise noted.

SYMBOL	PARAMETER	CONDITIONS	MIN	TYP	MAX	UNITS
$T_{LIM}$	Junction Temperature in Constant Temperature Mode			120		$^\circ\text{C}$
$R_{ON}$	Power FET "ON" Resistance (Between $V_{CC}$ and BAT)			600		$\text{m}\Omega$
$t_{SS}$	Soft-Start Time	$I_{BAT} = 0$ to $I_{BAT} = 1000\text{V}/R_{PROG}$		100		$\mu\text{s}$
$t_{RECHARGE}$	Recharge Comparator Filter Time	$V_{BSENSE}$ High to Low	0.75	2	4.5	ms
$t_{TERM}$	Termination Comparator Filter Time	$I_{BAT}$ Drops Below $I_{CHG}/10$	400	1000	2500	$\mu\text{s}$

**Note 1:** Absolute Maximum Ratings are those values beyond which the life of the device may be impaired.

**Note 2:** The LTC4058E-4.2/LTC4058XE-4.2 are guaranteed to meet performance specifications from  $0^\circ\text{C}$  to  $70^\circ\text{C}$ . Specifications over the  $-40^\circ\text{C}$  to  $85^\circ\text{C}$  operating temperature range are assured by design, characterization and correlation with statistical process controls.

**Note 3:** Failure to solder the exposed backside of the package to the PC board will result in a thermal resistance much higher than  $40^\circ\text{C}/\text{W}$ .

**Note 4:** Supply current includes PROG pin current (approximately  $100\mu\text{A}$ ) but does not include any current delivered to the battery through the BAT pin (approximately  $100\text{mA}$ ).

**Note 5:** For all Li-Ion applications, the BSENSE pin must be electrically connected to the BAT pin.

**Note 6:** This parameter is not applicable to the LTC4058X.

**Note 7:**  $I_{TERM}$  is expressed as a fraction of measured full charge current with indicated PROG resistor.

**TYPICAL PERFORMANCE CHARACTERISTICS**

**PROG Pin Voltage vs Supply Voltage (Constant Current Mode)**

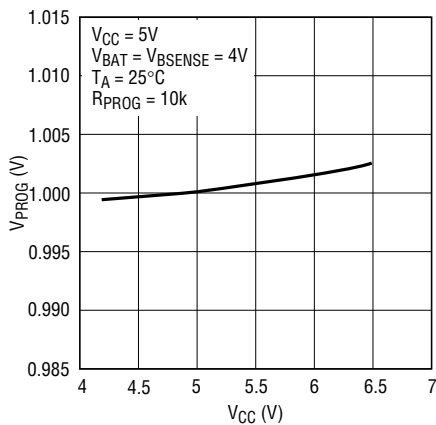

405842 G01

**PROG Pin Voltage vs Temperature**

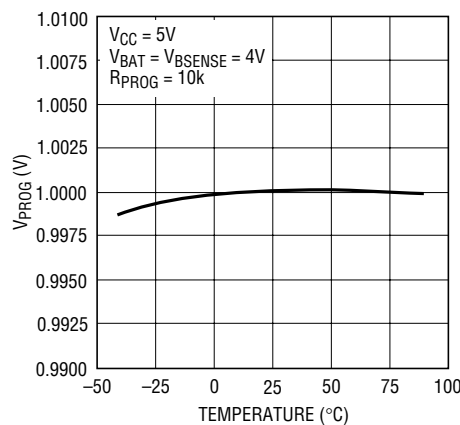

405842 G02

**Charge Current vs PROG Pin Voltage**

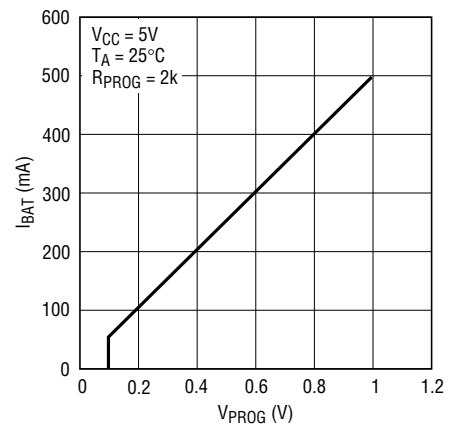

405842 G03

# TYPICAL PERFORMANCE CHARACTERISTICS

**Regulated Output (Float) Voltage vs Charge Current**

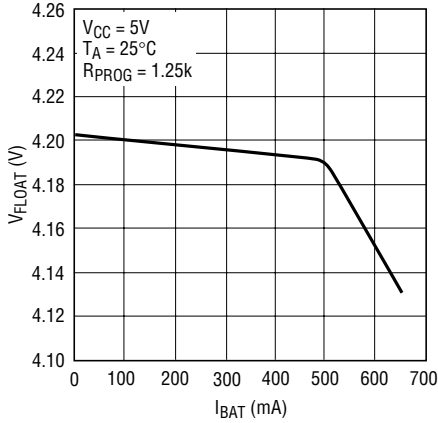

405842 G04

**Regulated Output (Float) Voltage vs Temperature**

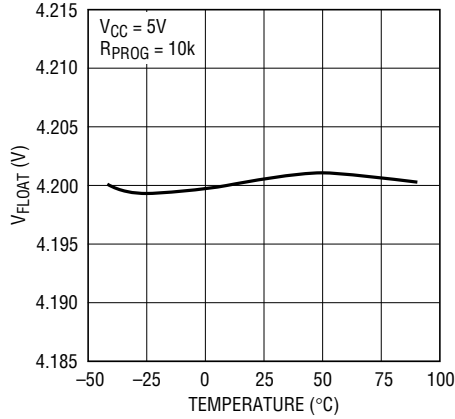

405842 G05

**Regulated Output (Float) Voltage vs Supply Voltage**

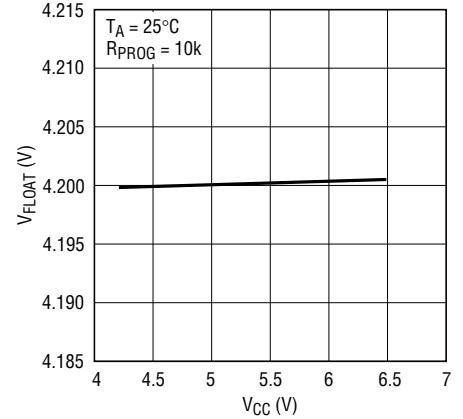

405842 G06

**CHRG Pin I-V Curve (Pull-Down State)**

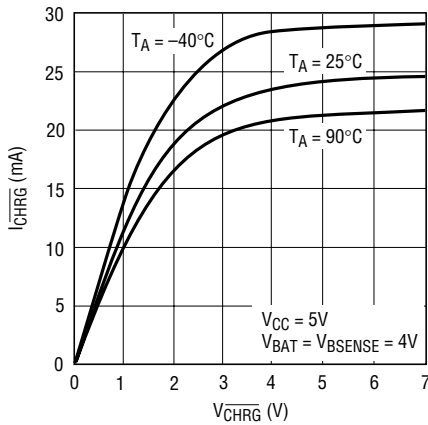

405842 G07

**ACPR Pin I-V Curve (Pull-Down State)**

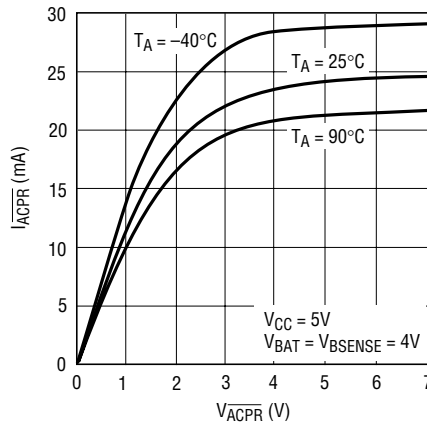

405842 G08

**Trickle Charge Current vs Temperature**

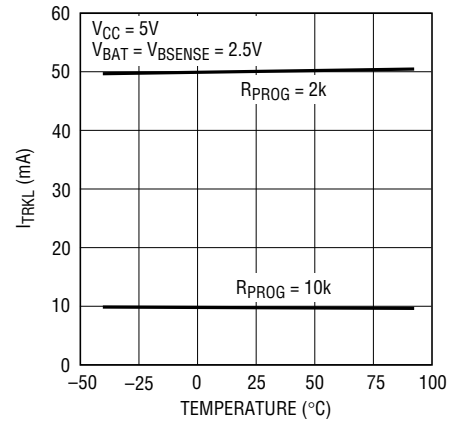

405842 G09

**Trickle Charge Current vs Supply Voltage**

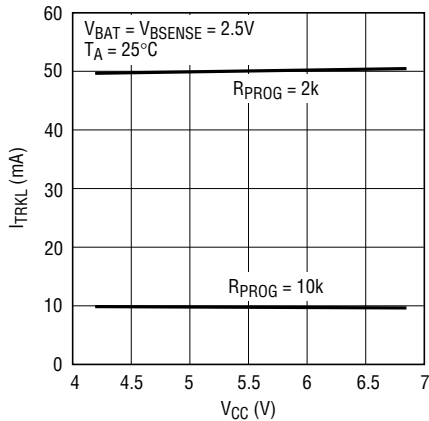

405842 G10

**Trickle Charge Threshold Voltage vs Temperature**

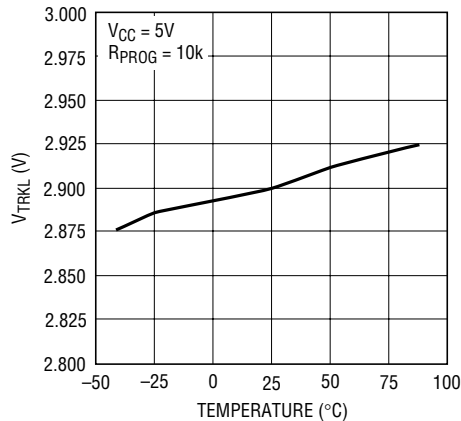

405842 G11

**Charge Current vs Battery Voltage**

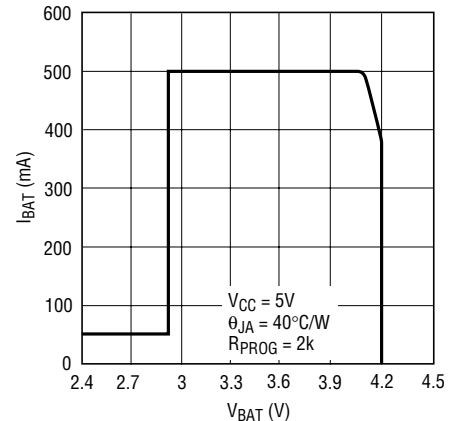

405842 G08

## TYPICAL PERFORMANCE CHARACTERISTICS

### Charge Current vs Supply Voltage

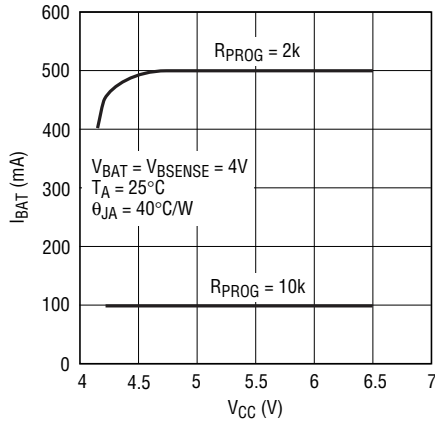

405842 G13

### Charge Current vs Ambient Temperature

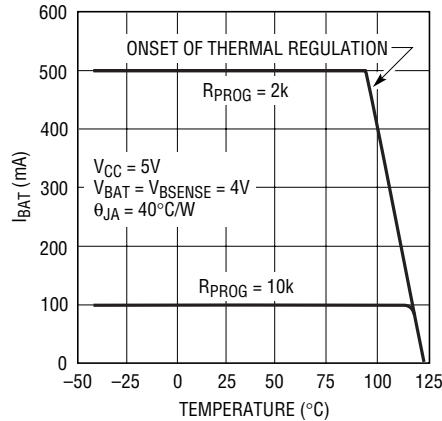

405842 G14

### Recharge Threshold Voltage vs Temperature

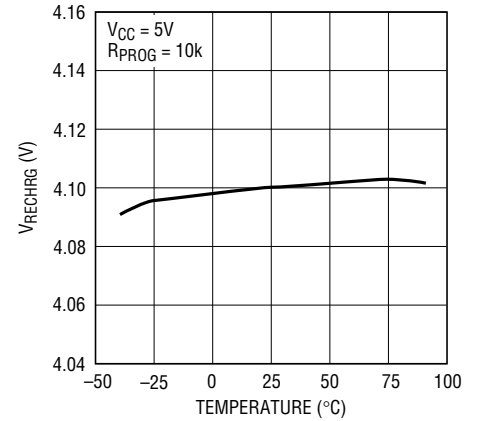

405842 G15

### Power FET Transistor Curve

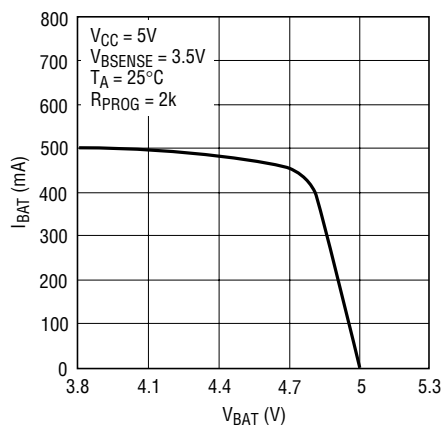

405842 G16

### Power FET "ON" Resistance vs Temperature

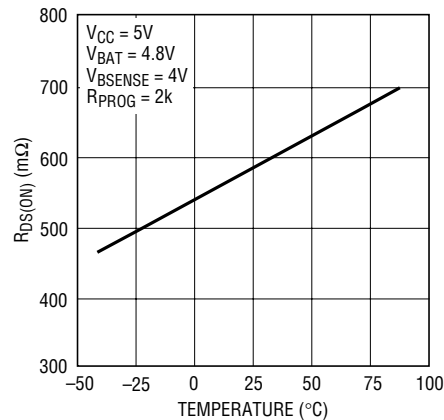

405842 G17

## PIN FUNCTIONS

**BSENSE (Pin 1):** Battery Sense. This pin is used to Kelvin sense the positive battery terminal and regulate the final float voltage to 4.2V. An internal precision resistor divider sets this float voltage and is disconnected in shutdown mode. **For Li-Ion applications, this pin must be electrically connected to BAT.**

**BAT (Pin 2):** Charge Current Output. Provides charge current to the battery from the internal P-channel MOSFET.

**CHRG (Pin 3):** Charge Status Open-Drain Output. When the battery is charging, the CHRG pin is pulled low by an

internal N-channel MOSFET. When the charge cycle is completed,  $\overline{CHRG}$  becomes high impedance.

**GND (Pins 4, 9):** Ground/Exposed Pad. The exposed backside of the package (Pin 9) is also ground and must be soldered to the PC board for maximum heat transfer.

**PROG (Pin 5):** Charge Current Program and Charge Current Monitor. Charge current is programmed by connecting a 1% resistor,  $R_{PROG}$ , to ground. When charging in constant-current mode, this pin serves to 1V. In all modes,

## PIN FUNCTIONS

the voltage on this pin can be used to measure the charge current using the following formula:

$$I_{BAT} = (V_{PROG}/R_{PROG}) \cdot 1000$$

This pin is clamped to approximately 2.4V. Driving this pin to voltages beyond the clamp voltage can draw currents as high as 1.5mA.

**V<sub>CC</sub> (Pin 6):** Positive Input Supply Voltage. Provides power to the charger. V<sub>CC</sub> can range from 4.25V to 6.5V. This pin should be bypassed with at least a 1μF capacitor. When V<sub>CC</sub> is within 100mV of the BSENSE pin voltage, the LTC4058 enters shutdown mode dropping the battery drain current to less than 2μA.

**ACPR (Pin 7):** Power Supply Status Open-Drain Output. When V<sub>CC</sub> is greater than the undervoltage lockout threshold and at least 100mV above V<sub>BSENSE</sub>, the ACPR pin is pulled to ground; otherwise, the pin is high impedance.

**EN (Pin 8):** Enable Input. A logic high on the EN pin will put the LTC4058 into shutdown mode where the battery drain current is reduced to less than 2μA and the supply current is reduced to less than 50μA. A logic low or floating the EN pin (allowing an internal 2MΩ pull-down resistor to pull this pin low) enables charging.

## BLOCK DIAGRAM

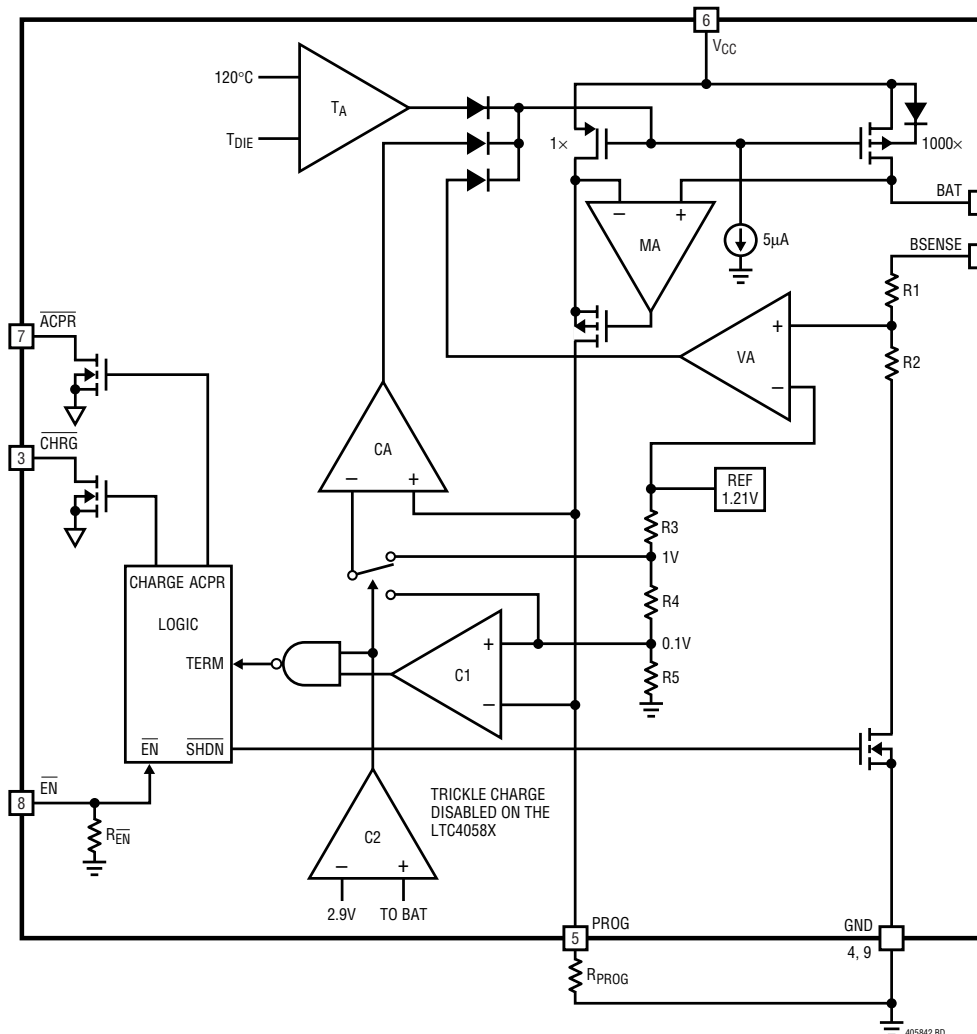

## OPERATION

The LTC4058 is a single cell lithium-ion battery charger using a constant-current/constant-voltage algorithm. It can deliver up to 950mA of charge current (using a good thermal PCB layout) with a final float voltage accuracy of  $\pm 1\%$ . The LTC4058 includes an internal P-channel power MOSFET and thermal regulation circuitry. No blocking diode or external current sense resistor is required; thus, the basic charger circuit requires only two external components. Furthermore, the LTC4058 is capable of operating from a USB power source.

### Normal Charge Cycle

A charge cycle begins when the voltage at the  $V_{CC}$  pin rises above the UVLO threshold level and a 1% program resistor is connected from the PROG pin to ground. If the BSENSE pin is less than 2.9V, the charger enters trickle charge mode. In this mode, the LTC4058 supplies approximately 1/10th the programmed charge current to bring the battery voltage up to a safe level for full current charging. (Note: The LTC4058X does not include this trickle charge feature.)

When the BSENSE pin voltage rises above 2.9V, the charger enters constant-current mode where the programmed charge current is supplied to the battery. When the BSENSE pin approaches the final float voltage (4.2V), the LTC4058 enters constant-voltage mode and the charge current begins to decrease. When the charge current drops to 1/10th of the programmed value, the charge cycle ends.

### Programming Charge Current

The charge current is programmed using a single resistor from the PROG pin to ground. The charge current out of the BAT pin is 1000 times the current out of the PROG pin. The program resistor and the charge current are calculated using the following equations:

$$R_{\text{PROG}} = \frac{1000V}{I_{\text{CHG}}}, \quad I_{\text{CHG}} = \frac{1000V}{R_{\text{PROG}}}$$

Charge current out of the BAT pin can be determined at any time by monitoring the PROG pin voltage and using the following equation:

$$I_{\text{BAT}} = \frac{V_{\text{PROG}}}{R_{\text{PROG}}} \cdot 1000$$

### Charge Termination

The charge cycle terminates when the charge current falls to 10% the programmed value after the final float voltage is reached. This condition is detected by using an internal, filtered comparator to monitor the PROG pin. When the PROG pin voltage falls below 100mV<sup>1</sup> for longer than  $t_{\text{TERM}}$  (typically 1ms), charging is terminated. The charge current is latched off and the LTC4058 enters standby mode where the input supply current drops to 200 $\mu$ A. (Note: C/10 termination is disabled in trickle charging and thermal limiting modes.)

When charging, transient loads on the BAT pin can cause the PROG pin to fall below 100mV for short periods of time before the DC charge current has dropped to 10% of the programmed value. The 1ms filter time ( $t_{\text{TERM}}$ ) on the termination comparator ensures that transient loads of this nature do not result in premature charge cycle termination. Once the *average* charge current drops below 10% of the programmed value, the LTC4058 terminates the charge cycle and ceases to provide any current through the BAT pin. In this state, all loads on the BAT pin must be supplied by the battery.

The LTC4058 constantly monitors the BAT pin voltage in standby mode. If this voltage drops below the 4.1V recharge threshold ( $V_{\text{RECHRG}}$ ), another charge cycle begins and charge current is once again supplied to the battery. To manually restart a charge cycle when in standby mode, the input voltage must be removed and reapplied or the charger must be shut down and restarted using the  $\overline{\text{EN}}$  pin. Figure 1 shows the state diagram of a typical charge cycle.

### Charge Status Indicator ( $\overline{\text{CHRG}}$ )

The charge status output has two states: pull-down and high impedance. The pull-down state indicates that the LTC4058 is in a charge cycle. Once the charge cycle has terminated or the LTC4058 is disabled, the pin state becomes high impedance.

<sup>1</sup>Any external sources that hold the PROG pin above 100mV will prevent the LTC4058 from terminating a charge cycle.

## OPERATION

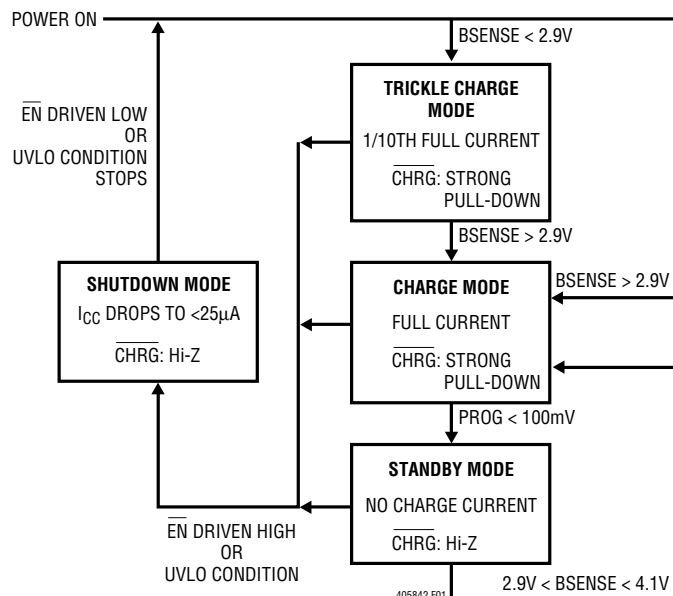

Figure 1. State Diagram of a Typical Charge Cycle

### Power Supply Status Indicator ( $\overline{ACPR}$ )

The power supply status output has two states: pull-down and high impedance. The pull-down state indicates that  $V_{CC}$  is above the UVLO threshold (3.8V) and is also 100mV above the battery voltage. When these conditions are not met, the  $\overline{ACPR}$  pin is high impedance indicating that the LTC4058 is unable to charge the battery.

### Thermal Limiting

An internal thermal feedback loop reduces the programmed charge current if the die temperature attempts to rise above a preset value of approximately 120°C. This feature protects the LTC4058 from excessive temperature and allows the user to push the limits of the power handling capability of a given circuit board without risk of damaging the LTC4058. The charge current can be set according to typical (not worst case) ambient temperature with the assurance that the

charger will automatically reduce the current in worst-case conditions. DFN power considerations are discussed further in the Applications Information section.

### Undervoltage Lockout (UVLO)

An internal undervoltage lockout circuit monitors the input voltage and keeps the charger in shutdown mode until  $V_{CC}$  rises above the undervoltage lockout threshold. The UVLO circuit has a built-in hysteresis of 200mV. Furthermore, to protect against reverse current in the power MOSFET, the UVLO circuit keeps the charger in shutdown mode if  $V_{CC}$  falls to within 30mV of the BSENSE voltage. If the UVLO comparator is tripped, the charger will not come out of shutdown mode until  $V_{CC}$  rises 100mV above the BSENSE voltage.

### Manual Shutdown

At any point in the charge cycle, the LTC4058 can be put into shutdown mode by driving the  $\overline{EN}$  pin high. This reduces the battery drain current to less than 2 $\mu A$  and the supply current to less than 50 $\mu A$ . When in shutdown mode, the  $\overline{CHRG}$  pin is in the high impedance state. A new charge cycle can be initiated by driving the  $\overline{EN}$  pin low. A resistor pull-down on this pin forces the LTC4058 to be enabled if the pin is allowed to float.

### Automatic Recharge

Once the charge cycle is terminated, the LTC4058 continuously monitors the voltage on the BSENSE pin using a comparator with a 2ms filter time ( $t_{RECHARGE}$ ). A charge cycle restarts when the battery voltage falls below 4.10V (which corresponds to approximately 80% to 90% battery capacity). This ensures that the battery is kept at, or near, a fully charged condition and eliminates the need for periodic charge cycle initiations. The  $\overline{CHRG}$  output enters a pull-down state during recharge cycles.



## APPLICATIONS INFORMATION

### Kelvin Sensing the Battery (BSENSE Pin)

The internal P-channel MOSFET drain is connected to the BAT pin, while the BSENSE pin connects through an internal precision resistor divider to the input of the constant-voltage amplifier. This architecture allows the BSENSE pin to Kelvin sense the positive battery terminal. This is especially useful when the copper trace from the BAT pin to the Li-Ion battery is long and has a high resistance. High charge currents can cause a significant voltage drop between the positive battery terminal and the BAT pin. In this situation, a separate trace from the BSENSE pin to the battery terminals will eliminate this voltage error and result in more accurate battery voltage sensing. **The BSENSE pin MUST be electrically connected to the BAT pin.**

### Stability Considerations

The constant-voltage mode feedback loop is stable without an output capacitor, provided a battery is connected to the charger output. With no battery present, an output capacitor on the BAT pin is recommended to reduce ripple voltage. When using high value, low ESR ceramic capacitors, it is recommended to add a 1Ω resistor in series with the capacitor. No series resistor is needed if tantalum capacitors are used.

In constant-current mode, the PROG pin is in the feedback loop, not the battery. The constant-current mode stability is affected by the impedance at the PROG pin. With no additional capacitance on the PROG pin, the charger is stable with program resistor values as high as 20k; however, additional capacitance on this node reduces the maximum allowed program resistor. The pole frequency at the PROG pin should be kept above 100kHz. Therefore, if the PROG pin is loaded with a capacitance,  $C_{PROG}$ , the following equation can be used to calculate the maximum resistance value for  $R_{PROG}$ :

$$R_{PROG} \leq \frac{1}{2\pi \cdot 10^5 \cdot C_{PROG}}$$

Average, rather than instantaneous charge current may be of interest to the user. For example, if a switching power supply operating in low current mode is connected in parallel with the battery, the average current being pulled

out of the BAT pin is typically of more interest than the instantaneous current pulses. In such a case, a simple RC filter can be used on the PROG pin to measure the average battery current, as shown in Figure 2. A 10k resistor has been added between the PROG pin and the filter capacitor to ensure stability.

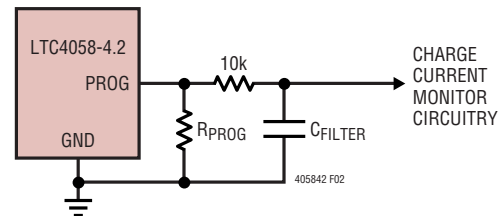

Figure 2. Isolating Capacitive Load on PROG Pin and Filtering

### Power Dissipation

It is not necessary to design for worst-case power dissipation scenarios because the LTC4058 automatically reduces the charge current during high power conditions. The conditions that cause the LTC4058 to reduce charge current through thermal feedback can be approximated by considering the power dissipated in the IC. Nearly all of this power dissipation is generated by the internal MOSFET—this is calculated to be approximately:

$$P_D = (V_{CC} - V_{BAT}) \cdot I_{BAT}$$

where  $P_D$  is the power dissipated,  $V_{CC}$  is the input supply voltage,  $V_{BAT}$  is the battery voltage and  $I_{BAT}$  is the charge current. The approximate ambient temperature at which the thermal feedback begins to protect the IC is:

$$T_A = 120^\circ\text{C} - P_D \theta_{JA}$$

$$T_A = 120^\circ\text{C} - (V_{CC} - V_{BAT}) \cdot I_{BAT} \cdot \theta_{JA}$$

Example: An LTC4058 operating from a 5V supply is programmed to supply 800mA full-scale current to a discharged Li-Ion battery with a voltage of 3.3V. Assuming  $\theta_{JA}$  is 50°C/W (see Thermal Considerations), the ambient temperature at which the LTC4058 will begin to reduce the charge current is approximately:

$$T_A = 120^\circ\text{C} - (5\text{V} - 3.3\text{V}) \cdot (800\text{mA}) \cdot 50^\circ\text{C}/\text{W}$$

$$T_A = 120^\circ\text{C} - 1.36\text{W} \cdot 50^\circ\text{C}/\text{W} = 120^\circ\text{C} - 68^\circ\text{C}$$

$$T_A = 52^\circ\text{C}$$

## APPLICATIONS INFORMATION

The LTC4058 can be used above 52°C ambient but the charge current will be reduced from 800mA. The approximate current at a given ambient temperature can be approximated by:

$$I_{BAT} = \frac{120^{\circ}\text{C} - T_A}{(V_{CC} - V_{BAT}) \cdot \theta_{JA}}$$

Using the previous example with an ambient temperature of 60°C, the charge current will be reduced to approximately:

$$I_{BAT} = \frac{120^{\circ}\text{C} - 60^{\circ}\text{C}}{(5\text{V} - 3.3\text{V}) \cdot 50^{\circ}\text{C/W}} = \frac{60^{\circ}\text{C}}{85^{\circ}\text{C/A}}$$

$$I_{BAT} = 706\text{mA}$$

Moreover, when thermal feedback reduces the charge current the voltage at the PROG pin is also reduced proportionally as discussed in the Operation section. It is important to remember that LTC4058 applications do not need to be designed for worst-case thermal conditions since the IC will automatically reduce power dissipation when the junction temperature reaches approximately 120°C.

### Thermal Considerations

In order to deliver maximum charge current under all conditions, it is critical that the exposed metal pad on the backside of the LTC4058 package is soldered to the PC board ground. Correctly soldered to a 2500mm<sup>2</sup> double-sided 1oz copper board, the LTC4058 has a thermal resistance of approximately 40°C/W. Failure to make thermal contact between the exposed pad on the backside of the package and the copper board will result in thermal resistances far greater than 40°C/W. As an example, a correctly soldered LTC4058 can deliver over 800mA to a battery from a 5V supply at room temperature. Without a backside thermal connection, this number will drop considerably.

### V<sub>CC</sub> Bypass Capacitor

Many types of capacitors can be used for input bypassing, however, caution must be exercised when using multilayer

ceramic capacitors. Because of the self-resonant and high Q characteristics of some types of ceramic capacitors, high voltage transients can be generated under some start-up conditions such as connecting the charger input to a live power source. Adding a 1.5Ω resistor in series with an X5R ceramic capacitor will minimize start-up voltage transients. For more information, see Application Note 88.

### Charge Current Soft-Start

The LTC4058 includes a soft-start circuit to minimize the inrush current at the start of a charge cycle. When a charge cycle is initiated, the charge current ramps from zero to the full-scale current over a period of approximately 100μs. This has the effect of minimizing the transient current load on the power supply during start-up.

### USB and Wall Adapter Power

The LTC4058 allows charging from both a wall adapter and a USB port. Figure 3 shows an example of how to combine wall adapter and USB power inputs. A P-channel MOSFET, MP1, is used to prevent back conducting into the USB port when a wall adapter is present and a Schottky diode, D1, is used to prevent USB power loss through the 1k pull-down resistor.

Typically a wall adapter can supply more current than the 500mA-limited USB port. Therefore, an N-channel MOSFET, MN1, and an extra 3.3k program resistor are used to increase the charge current to 800mA when the wall adapter is present.

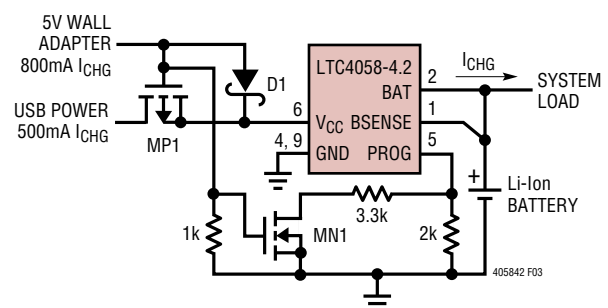

Figure 3. Combining Wall Adapter and USB Power

## APPLICATIONS INFORMATION

### Reverse Polarity Input Voltage Protection

In some applications, protection from reverse polarity voltage on  $V_{CC}$  is desired. If the supply voltage is high enough, a series blocking diode can be used. In other cases, where the voltage drop must be kept low, a P-channel MOSFET can be used (as shown in Figure 4).

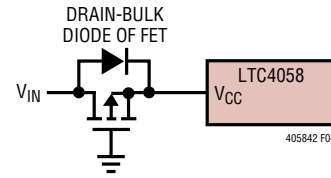
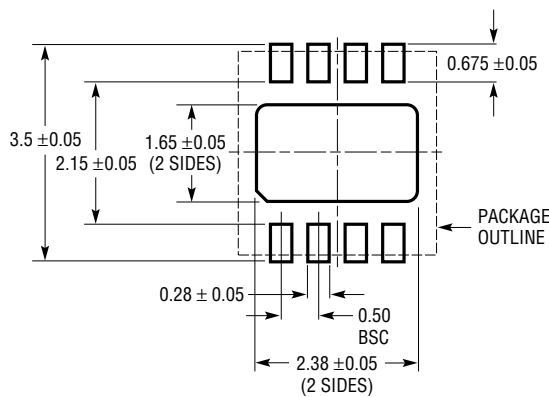

Figure 4. Low Loss Input Reverse Polarity Protection

## PACKAGE DESCRIPTION

### DD Package 8-Lead Plastic DFN (3mm × 3mm) (Reference LTC DWG # 05-08-1698)



RECOMMENDED SOLDER PAD PITCH AND DIMENSIONS

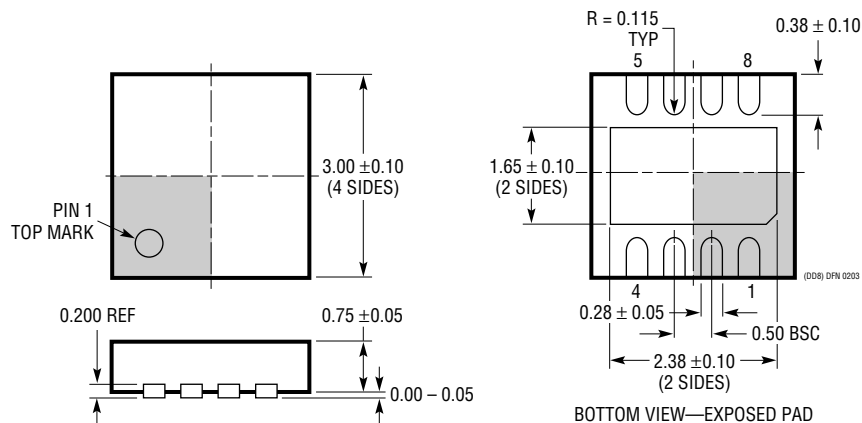

NOTE:

1. DRAWING TO BE MADE A JEDEC PACKAGE OUTLINE M0-229 VARIATION OF (WEED-1)
2. ALL DIMENSIONS ARE IN MILLIMETERS
3. DIMENSIONS OF EXPOSED PAD ON BOTTOM OF PACKAGE DO NOT INCLUDE MOLD FLASH. MOLD FLASH, IF PRESENT, SHALL NOT EXCEED 0.15mm ON ANY SIDE
4. EXPOSED PAD SHALL BE SOLDER PLATED

## TYPICAL APPLICATIONS

### Full Featured Single Cell Li-Ion Charger

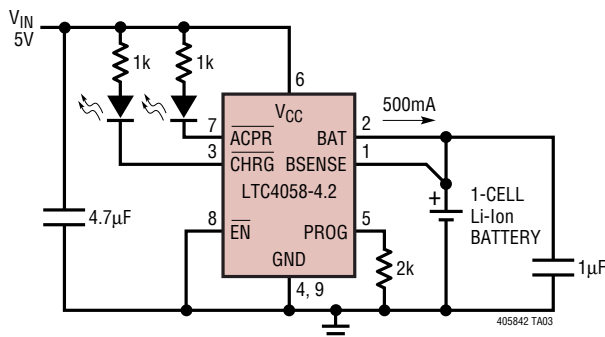

### Li-Ion Battery Charger with Reverse Polarity Input Protection

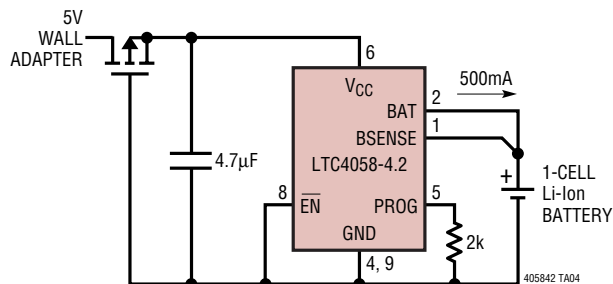

### USB/Wall Adapter Power Li-Ion Charger

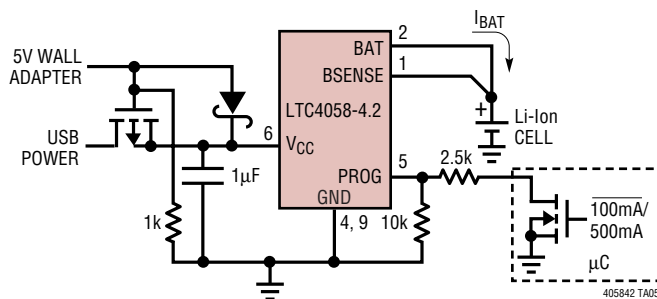

## RELATED PARTS

PART NUMBER	DESCRIPTION	COMMENTS
LTC1732	Lithium-Ion Linear Battery Charger Controller	Simple Charger uses External FET, Features Preset Voltages, C/10 Charger Detection and Programmable Timer, Input Power Good Indication
LTC1733	Monolithic Lithium-Ion Linear Battery Charger	Standalone Charger with Programmable Timer, Up to 1.5A Charge Current
LTC1734	Lithium-Ion Linear Battery Charger in ThinSOT™	Simple ThinSOT Charger, No Blocking Diode, No Sense Resistor Needed
LTC1734L	Lithium-Ion Linear Battery Charger in ThinSOT	Low Current Version of LTC1734; 50mA ≤ I <sub>CHRG</sub> ≤ 180mA
LTC1998	Lithium-Ion Low Battery Detector	1% Accurate 2.5μA Quiescent Current, SOT-23
LTC4007	4A Multicell Li-Ion Battery Charger	Standalone Charger, 6V ≤ V <sub>IN</sub> ≤ 28V, Up to 96% Efficiency, ±0.8% Charging Voltage Accuracy
LTC4050	Lithium-Ion Linear Battery Charger Controller	Features Preset Voltages, C/10 Charger Detection and Programmable Timer, Input Power Good Indication, Thermistor Interface
LTC4052	Monolithic Lithium-Ion Battery Pulse Charger	No Blocking Diode or External Power FET Required, ≤1.5A Charge Current
LTC4053	USB Compatible Monolithic Li-Ion Battery Charger	Standalone Charger with Programmable Timer, Up to 1.25A Charge Current
LTC4054	Standalone Linear Li-Ion Battery Charger with Integrated Pass Transistor in ThinSOT	Thermal Regulation Prevents Overheating, C/10 Termination, C/10 Indicator, Up to 800mA Charge Current
LTC4057	Li-Ion Linear Battery Charger	Up to 800mA Charge Current, Thermal Regulation, ThinSOT Package
LTC4410	USB Power Manager	For Simultaneous Operation of USB Peripheral and Battery Charging from USB Port, Keeps Current Drawn from USB Port Constant, Keeps Battery Fresh, Use with the LTC4053, LTC1733, or LTC4054
LTC4412	Low Loss PowerPath™ Controller in ThinSOT	Automatic Switching Between DC Sources, Load Sharing, Replaces ORing Diodes

ThinSOT and PowerPath are trademarks of Linear Technology Corporation.

sn405842 405842fs

Компания «Океан Электроники» предлагает заключение долгосрочных отношений при поставках импортных электронных компонентов на взаимовыгодных условиях!

Наши преимущества:

- Поставка оригинальных импортных электронных компонентов напрямую с производств Америки, Европы и Азии, а так же с крупнейших складов мира;
- Широкая линейка поставок активных и пассивных импортных электронных компонентов (более 30 млн. наименований);
- Поставка сложных, дефицитных, либо снятых с производства позиций;
- Оперативные сроки поставки под заказ (от 5 рабочих дней);
- Экспресс доставка в любую точку России;
- Помощь Конструкторского Отдела и консультации квалифицированных инженеров;
- Техническая поддержка проекта, помощь в подборе аналогов, поставка прототипов;
- Поставка электронных компонентов под контролем ВП;
- Система менеджмента качества сертифицирована по Международному стандарту ISO 9001;
- При необходимости вся продукция военного и аэрокосмического назначения проходит испытания и сертификацию в лаборатории (по согласованию с заказчиком);
- Поставка специализированных компонентов военного и аэрокосмического уровня качества (Xilinx, Altera, Analog Devices, Intersil, Interpoint, Microsemi, Actel, Aeroflex, Peregrine, VPT, Syfer, Eurofarad, Texas Instruments, MS Kennedy, Miteq, Cobham, E2V, MA-COM, Hittite, Mini-Circuits, General Dynamics и др.);

Компания «Океан Электроники» является официальным дистрибьютором и эксклюзивным представителем в России одного из крупнейших производителей разъемов военного и аэрокосмического назначения «JONHON», а так же официальным дистрибьютором и эксклюзивным представителем в России производителя высокотехнологичных и надежных решений для передачи СВЧ сигналов «FORSTAR».



## JONHON

«JONHON» (основан в 1970 г.)

Разъемы специального, военного и аэрокосмического назначения:

(Применяются в военной, авиационной, аэрокосмической, морской, железнодорожной, горно- и нефтедобывающей отраслях промышленности)

«FORSTAR» (основан в 1998 г.)

ВЧ соединители, коаксиальные кабели, кабельные сборки и микроволновые компоненты:

(Применяются в телекоммуникациях гражданского и специального назначения, в средствах связи, РЛС, а так же военной, авиационной и аэрокосмической отраслях промышленности).



Телефон: 8 (812) 309-75-97 (многоканальный)

Факс: 8 (812) 320-03-32

Электронная почта: [ocean@oceanchips.ru](mailto:ocean@oceanchips.ru)

Web: <http://oceanchips.ru/>

Адрес: 198099, г. Санкт-Петербург, ул. Калинина, д. 2, корп. 4, лит. А