

Optocoupler, Phototriac Output, Zero Crossing, High dV/dt, Low Input Current

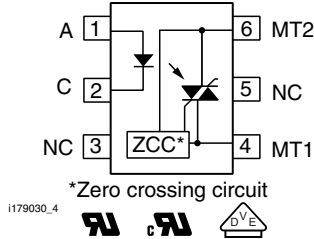

21842-1



i179030_4



FEATURES

- High static dV/dt 5 kV/μs
- High input sensitivity $I_{FT} = 1.6$ mA, 2 mA, and 3 mA
- 300 mA on-state current
- Zero voltage crossing detector
- 700 V and 800 V blocking voltage
- Isolation test voltage 5300 V_{RMS}
- Compliant to RoHS Directive 2011/65/EU



RoHS
COMPLIANT

DESCRIPTION

The VO4157 and VO4158 consists of a GaAs IRLED optically coupled to a photosensitive zero crossing TRIAC packaged in a DIP-6 package.

High input sensitivity is achieved by using an emitter follower phototransistor and a cascaded SCR predriver resulting in an LED trigger current of 1.6 mA for bin D, 2 mA for bin H, and 3 mA for bin M.

The new phototriac zero crossing family uses a proprietary dV/dt clamp resulting in a static dV/dt of greater than 5 kV/μs.

The VO4157 and VO4158 isolates low-voltage logic from 120 V_{AC} , 240 V_{AC} , and 380 V_{AC} lines to control resistive, inductive, or capacitive loads including motors, solenoids, high current thyristors or TRIAC and relays.

APPLICATIONS

- Solid-state relays
- Industrial controls
- Office equipment
- Consumer appliances

AGENCY APPROVALS

- UL1577, file no. E52744 system code H or J, double protection
- cUL - file no. E52744, equivalent to CSA bulletin 5A
- DIN EN 60747-5-2 (VDE 0884) available with option 1
- FIMKO

| ORDERING INFORMATION | | | | | | |
|--------------------------|--------------------------------|---------------|----------------|---------------|---------------|---------------|
| | | | | | | |
| PART NUMBER | | | PACKAGE OPTION | | TAPE AND REEL | |
| | | | | | | |
| | | | | | | |
| AGENCY CERTIFIED/PACKAGE | V_{DRM} 700 | | | V_{DRM} 800 | | |
| | TRIGGER CURRENT, I_{FT} (mA) | | | | | |
| UL, cUL | 1.6 | 2 | 3 | 1.6 | 2 | 3 |
| DIP-6 | VO4157D | VO4157H | VO4157M | VO4158D | VO4158H | VO4158M |
| DIP-6, 400 mil, option 6 | VO4157D-X006 | VO4157H-X006 | VO4157M-X006 | VO4158D-X006 | VO4158H-X006 | VO4158M-X006 |
| SMD-6, option 7 | VO4157D-X007T | VO4157H-X007T | VO4157M-X007T | VO4158D-X007T | VO4158H-X007T | VO4158M-X007T |
| VDE, UL, cUL | 1.6 | 2 | 3 | 1.6 | 2 | 3 |
| DIP-6 | - | - | VO4157M-X001 | - | - | - |
| DIP-6, 400 mil, option 6 | - | - | - | - | - | VO4158M-X016 |
| SMD-6, option 7 | VO4157D-X017T | VO4157H-X017T | VO4157M-X017T | - | VO4158H-X017T | - |
| SMD-6, option 8 | - | - | - | - | - | VO4158M-X018T |



| ABSOLUTE MAXIMUM RATINGS (T _{amb} = 25 °C, unless otherwise specified) | | | | | |
|--|--|-------------|------------------|---------------|------------------|
| PARAMETER | TEST CONDITION | PART | SYMBOL | VALUE | UNIT |
| INPUT | | | | | |
| Reverse voltage | | | V _R | 6 | V |
| Forward current | | | I _F | 60 | mA |
| Surge current | | | I _{FSM} | 2.5 | A |
| Derate from 25 °C | | | | 1.33 | mW/°C |
| OUTPUT | | | | | |
| Peak off-state voltage | | VO4157D/H/M | V _{DRM} | 700 | V |
| | | VO4158D/H/M | V _{DRM} | 800 | V |
| RMS on-state current | | | I _{TM} | 300 | mA |
| Derate from 25 °C | | | | 6.6 | mW/°C |
| COUPLER | | | | | |
| Isolation test voltage (between emitter and detector, climate per DIN 500414, part 2, Nov. 74) | t = 1 min | | V _{ISO} | 5300 | V _{RMS} |
| Storage temperature range | | | T _{stg} | - 55 to + 150 | °C |
| Ambient temperature range | | | T _{amb} | - 55 to + 100 | °C |
| Soldering temperature | max. ≤ 10 s dip soldering ≥ 0.5 mm from case bottom | | T _{sld} | 260 | °C |

Note

- Stresses in excess of the absolute maximum ratings can cause permanent damage to the device. Functional operation of the device is not implied at these or any other conditions in excess of those given in the operational sections of this document. Exposure to absolute maximum ratings for extended periods of the time can adversely affect reliability. This phototriac should not be used to drive a load directly. It is intended to be a trigger device only.

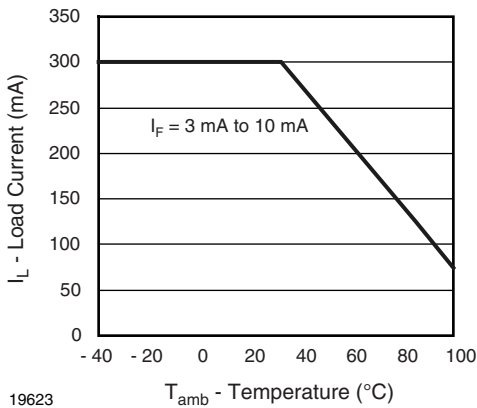

Fig. 1 - Recommended Operating Condition

| THERMAL CHARACTERISTICS | | | |
|---|----------------|-------|------|
| PARAMETER | SYMBOL | VALUE | UNIT |
| LED power dissipation | P_{diss} | 100 | mW |
| Output power dissipation | P_{diss} | 500 | mW |
| Total power dissipation | P_{tot} | 600 | mW |
| Maximum LED junction temperature | $T_{jmax.}$ | 125 | °C |
| Maximum output die junction temperature | $T_{jmax.}$ | 125 | °C |
| Thermal resistance, junction emitter to board | θ_{JEB} | 150 | °C/W |
| Thermal resistance, junction emitter to case | θ_{JEC} | 139 | °C/W |
| Thermal resistance, junction detector to board | θ_{JDB} | 78 | °C/W |
| Thermal resistance, junction detector to case | θ_{JDC} | 103 | °C/W |
| Thermal resistance, junction emitter to junction detector | θ_{JED} | 496 | °C/W |
| Thermal resistance, case to ambient | θ_{CA} | 3563 | °C/W |

Note

- The thermal characteristics table above were measured at 25 °C and the thermal model is represented in the thermal network below. Each resistance value given in this model can be used to calculate the temperatures at each node for a given operating condition. The thermal resistance from board to ambient will be dependent on the type of PCB, layout and thickness of copper traces. For a detailed explanation of the thermal model, please reference Vishay's Thermal Characteristics of Optocouplers application note.

| ELECTRICAL CHARACTERISTICS ($T_{amb} = 25\text{ °C}$, unless otherwise specified) | | | | | | | |
|---|---|-------------|--------------|------|------|------|------------------|
| PARAMETER | TEST CONDITION | PART | SYMBOL | MIN. | TYP. | MAX. | UNIT |
| INPUT | | | | | | | |
| Forward voltage | $I_F = 10\text{ mA}$ | | V_F | | 1.2 | 1.4 | V |
| Reverse current | $V_R = 6\text{ V}$ | | I_R | | 0.1 | 10 | μA |
| Input capacitance | $V_F = 0\text{ V}$, $f = 1\text{ MHz}$ | | C_i | | 25 | | pF |
| OUTPUT | | | | | | | |
| Repetitive peak off-state voltage | $I_{DRM} = 100\text{ }\mu\text{A}$ | VO4157D/H/M | V_{DRM} | 700 | | | V |
| | | VO4158D/H/M | V_{DRM} | 800 | | | V |
| Off-state current | $V_D = V_{DRM}$, $I_F = 0$ | | I_{DRM} | | | 100 | μA |
| On-state voltage | $I_T = 300\text{ mA}$ | | V_{TM} | | | 3 | V |
| On-state current | $PF = 1$, $V_{T(RMS)} = 1.7\text{ V}$ | | I_{TM} | | | 300 | mA |
| Off-state current in inhibit state | $I_F = 2\text{ mA}$, V_{DRM} | | I_{DINH} | | | 200 | μA |
| Holding current | | | I_H | | | 500 | μA |
| Zero cross inhibit voltage | $I_F = \text{rated } I_{FT}$ | | V_{IH} | | | 20 | V |
| Critical rate of rise of off-state voltage | $V_D = 0.67 V_{DRM}$, $T_J = 25\text{ °C}$ | | dV/dt_{cr} | 5000 | | | V/ μs |
| COUPLER | | | | | | | |
| LED trigger current, current required to latch output | $V_D = 3\text{ V}$ | VO4157D | I_{FT} | | | 1.6 | mA |
| | | VO4157H | I_{FT} | | | 2 | mA |
| | | VO4157M | I_{FT} | | | 3 | mA |
| | | VO4158D | I_{FT} | | | 1.6 | mA |
| | | VO4158H | I_{FT} | | | 2 | mA |
| | | VO4158M | I_{FT} | | | 3 | mA |
| Common mode coupling capacitance | | | C_{CM} | | 0.01 | | pF |
| Capacitance (input to output) | $f = 1\text{ MHz}$, $V_{IO} = 0\text{ V}$ | | C_{IO} | | 0.8 | | pF |

Note

- Minimum and maximum values were tested requirements. Typical values are characteristics of the device and are the result of engineering evaluations. Typical values are for information only and are not part of the testing requirements.



| SAFETY AND INSULATION RATINGS | | | | | | |
|--|----------------|------------|------|-----------|------|------|
| PARAMETER | TEST CONDITION | SYMBOL | MIN. | TYP. | MAX. | UNIT |
| Climatic classification (according to IEC68 part 1) | | | | 55/100/21 | | |
| Pollution degree (DIN VDE 0109) | | | | 2 | | |
| Comparative tracking index per DIN IEC112/VDE 0303 part 1, group IIIa per DIN VDE 6110 175 399 | | | 175 | | 399 | |
| V_{IOTM} | | V_{IOTM} | 8000 | | | V |
| V_{IORM} | | V_{IORM} | 890 | | | V |
| P_{SO} | | P_{SO} | | | 500 | mW |
| I_{SI} | | I_{SI} | | | 250 | mA |
| T_{SI} | | T_{SI} | | | 175 | °C |
| Creepage distance | | | 7 | | | mm |

TYPICAL CHARACTERISTICS ($T_{amb} = 25\text{ }^{\circ}\text{C}$, unless otherwise specified)



19997

Fig. 2 - Diode Forward Voltage vs. Forward Current

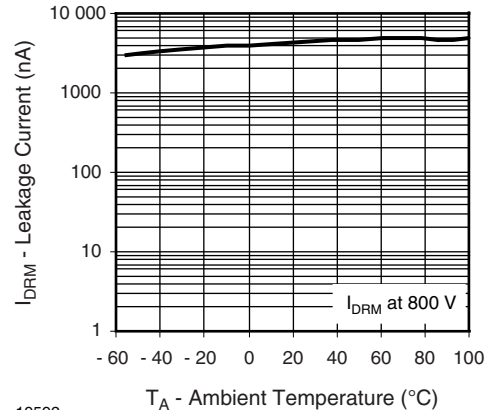

19592

Fig. 4 - Leakage Current vs. Ambient Temperature

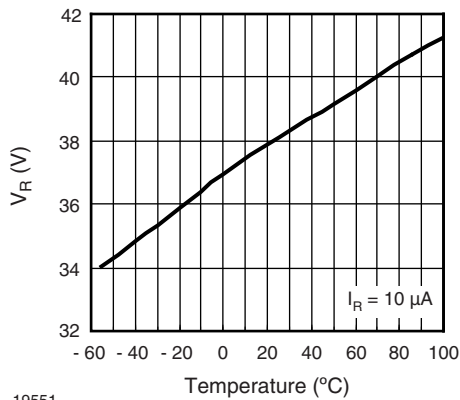

19551

Fig. 3 - Diode Reverse Voltage vs. Temperature

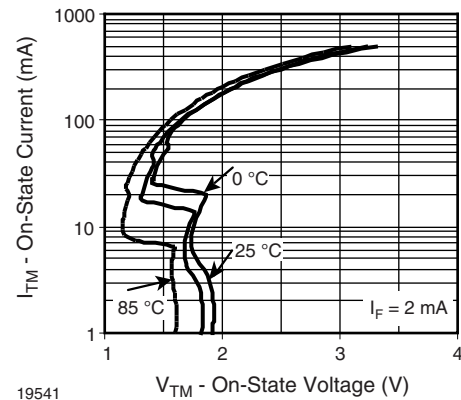

19541

Fig. 5 - On State Current vs. On State Voltage



19453

Fig. 6 - Output Off Current (Leakage) vs. Voltage

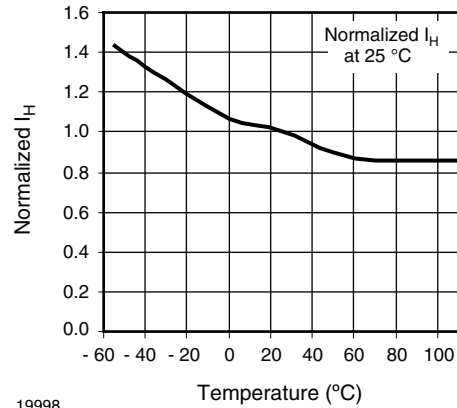

19998

Fig. 9 - Normalized Holding Current vs. Temperature



19454

Fig. 7 - Normalized Trigger Input Current vs. Temperature



20005

Fig. 10 - I_{FT} vs. LED Pulse Width



19624

Fig. 8 - Trigger Current vs. Turn-On Time

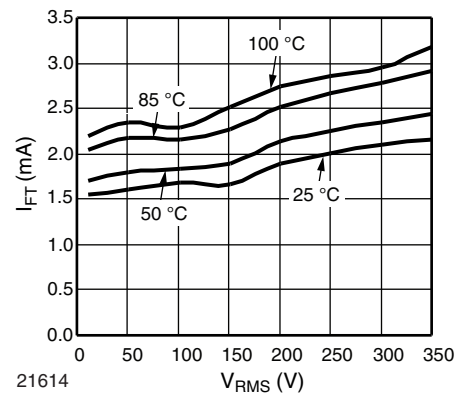

21614

Fig. 11 - I_{FT} vs. V_{RMS} and Temperature

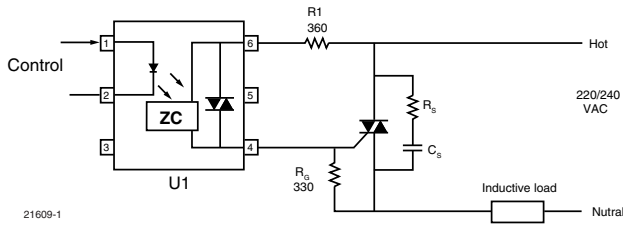

Fig. 12 - Basic Power Triac Driver Circuit

POWER FACTOR CONSIDERATIONS

As a zero voltage crossing optotriac, the commutating dV/dt spikes can inhibit one half of the TRIAC from turning on. If the spike potential exceeds the inhibit voltage of the zero-cross detection circuit, half of the TRIAC will be held-off and not turn-on. This hold-off condition can be eliminated by using a capacitor or RC snubber placed directly across the power triac as shown in fig. 11. Note that the value of the capacitor increases as a function of the load current.

The hold-off condition also can be eliminated by providing a higher level of LED drive current. The higher LED drive current provides a larger photocurrent which causes the phototransistor to turn-on before the commutating spike has activated the zero-cross detection circuit. For example, if a device requires 1.5 mA for a resistive load, then 2.7 mA (1.8 times) may be required to control an inductive load whose power factor is less than 0.3.

PACKAGE DIMENSIONS in millimeters

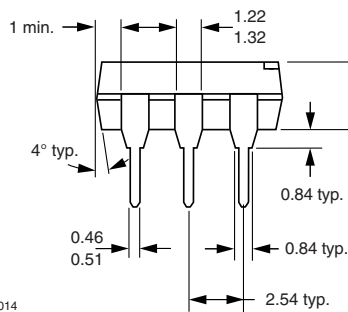
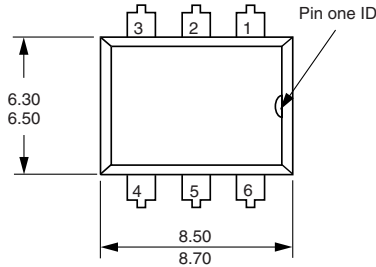

i178014

Option 6

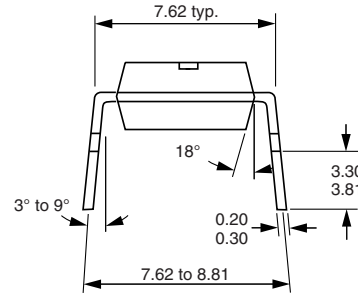

Option 7

Option 8

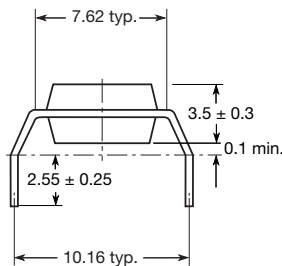

20802-41

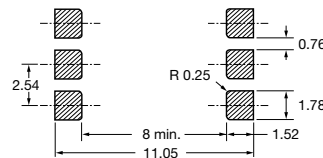
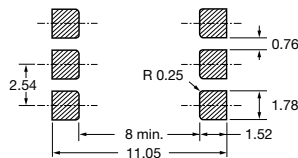
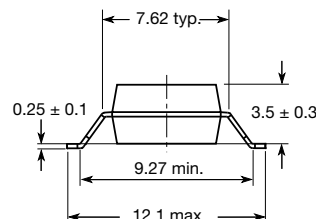
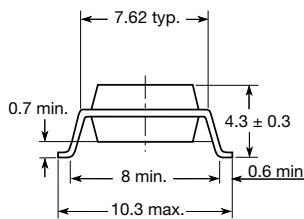



PACKAGE MARKING (example)

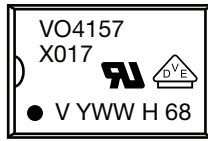

Notes

- VDE logo is only marked on option 1 parts. Tape and reel suffix (T) is not part of the package marking.



Disclaimer

ALL PRODUCT, PRODUCT SPECIFICATIONS AND DATA ARE SUBJECT TO CHANGE WITHOUT NOTICE TO IMPROVE RELIABILITY, FUNCTION OR DESIGN OR OTHERWISE.

Vishay Intertechnology, Inc., its affiliates, agents, and employees, and all persons acting on its or their behalf (collectively, "Vishay"), disclaim any and all liability for any errors, inaccuracies or incompleteness contained in any datasheet or in any other disclosure relating to any product.

Vishay makes no warranty, representation or guarantee regarding the suitability of the products for any particular purpose or the continuing production of any product. To the maximum extent permitted by applicable law, Vishay disclaims (i) any and all liability arising out of the application or use of any product, (ii) any and all liability, including without limitation special, consequential or incidental damages, and (iii) any and all implied warranties, including warranties of fitness for particular purpose, non-infringement and merchantability.

Statements regarding the suitability of products for certain types of applications are based on Vishay's knowledge of typical requirements that are often placed on Vishay products in generic applications. Such statements are not binding statements about the suitability of products for a particular application. It is the customer's responsibility to validate that a particular product with the properties described in the product specification is suitable for use in a particular application. Parameters provided in datasheets and/or specifications may vary in different applications and performance may vary over time. All operating parameters, including typical parameters, must be validated for each customer application by the customer's technical experts. Product specifications do not expand or otherwise modify Vishay's terms and conditions of purchase, including but not limited to the warranty expressed therein.

Except as expressly indicated in writing, Vishay products are not designed for use in medical, life-saving, or life-sustaining applications or for any other application in which the failure of the Vishay product could result in personal injury or death. Customers using or selling Vishay products not expressly indicated for use in such applications do so at their own risk. Please contact authorized Vishay personnel to obtain written terms and conditions regarding products designed for such applications.

No license, express or implied, by estoppel or otherwise, to any intellectual property rights is granted by this document or by any conduct of Vishay. Product names and markings noted herein may be trademarks of their respective owners.

Material Category Policy

Vishay Intertechnology, Inc. hereby certifies that all its products that are identified as RoHS-Compliant fulfill the definitions and restrictions defined under Directive 2011/65/EU of The European Parliament and of the Council of June 8, 2011 on the restriction of the use of certain hazardous substances in electrical and electronic equipment (EEE) - recast, unless otherwise specified as non-compliant.

Please note that some Vishay documentation may still make reference to RoHS Directive 2002/95/EC. We confirm that all the products identified as being compliant to Directive 2002/95/EC conform to Directive 2011/65/EU.

Vishay Intertechnology, Inc. hereby certifies that all its products that are identified as Halogen-Free follow Halogen-Free requirements as per JEDEC JS709A standards. Please note that some Vishay documentation may still make reference to the IEC 61249-2-21 definition. We confirm that all the products identified as being compliant to IEC 61249-2-21 conform to JEDEC JS709A standards.

Компания «Океан Электроники» предлагает заключение долгосрочных отношений при поставках импортных электронных компонентов на взаимовыгодных условиях!

Наши преимущества:

- Поставка оригинальных импортных электронных компонентов напрямую с производств Америки, Европы и Азии, а так же с крупнейших складов мира;
- Широкая линейка поставок активных и пассивных импортных электронных компонентов (более 30 млн. наименований);
- Поставка сложных, дефицитных, либо снятых с производства позиций;
- Оперативные сроки поставки под заказ (от 5 рабочих дней);
- Экспресс доставка в любую точку России;
- Помощь Конструкторского Отдела и консультации квалифицированных инженеров;
- Техническая поддержка проекта, помощь в подборе аналогов, поставка прототипов;
- Поставка электронных компонентов под контролем ВП;
- Система менеджмента качества сертифицирована по Международному стандарту ISO 9001;
- При необходимости вся продукция военного и аэрокосмического назначения проходит испытания и сертификацию в лаборатории (по согласованию с заказчиком);
- Поставка специализированных компонентов военного и аэрокосмического уровня качества (Xilinx, Altera, Analog Devices, Intersil, Interpoint, Microsemi, Actel, Aeroflex, Peregrine, VPT, Syfer, Eurofarad, Texas Instruments, MS Kennedy, Miteq, Cobham, E2V, MA-COM, Hittite, Mini-Circuits, General Dynamics и др.);

Компания «Океан Электроники» является официальным дистрибьютором и эксклюзивным представителем в России одного из крупнейших производителей разъемов военного и аэрокосмического назначения «JONHON», а так же официальным дистрибьютором и эксклюзивным представителем в России производителя высокотехнологичных и надежных решений для передачи СВЧ сигналов «FORSTAR».



JONHON

«JONHON» (основан в 1970 г.)

Разъемы специального, военного и аэрокосмического назначения:

(Применяются в военной, авиационной, аэрокосмической, морской, железнодорожной, горно- и нефтедобывающей отраслях промышленности)

«FORSTAR» (основан в 1998 г.)

ВЧ соединители, коаксиальные кабели,
кабельные сборки и микроволновые компоненты:

(Применяются в телекоммуникациях гражданского и специального назначения, в средствах связи, РЛС, а так же военной, авиационной и аэрокосмической отраслях промышленности).



Телефон: 8 (812) 309-75-97 (многоканальный)

Факс: 8 (812) 320-03-32

Электронная почта: ocean@oceanchips.ru

Web: <http://oceanchips.ru/>

Адрес: 198099, г. Санкт-Петербург, ул. Калинина, д. 2, корп. 4, лит. А