

Advantages of the 70S2 Series

Since acquiring this line of miniature SSRs from Grayhill, this product has continuously evolved both functionally and visually. The 70S2 Series relays are designed for medium-power loads. The design incorporates a triac output for AC loads and MOSFETs for DC loads. The 70S2 Series relays use optical isolation to protect the control from transients. The 70S2 compact package is available in a combination of screw, fast-on or PCB terminals. Its compact size makes it ideal for designs where space is limited. The 70S2 Series relays have excellent thermal performance.



- Switch up to 5 Amps
- Integrated Thermal Management
- PCB Mount

70S2 V (5 Amp)



70S2 V (3 Amp)



- Switch up to 25 Amps
- Screw Terminals
- Panel Mount

70S2 S



- Switch up to 12 Amps
- Blade Terminals
- Panel Mount

70S2 N

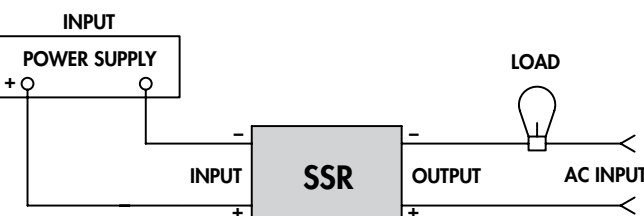

WIRING DIAGRAM

- **Small Packages**
Ideal for Tight Designs..
- **Eight Different Packages**
Wide Choice of Design Options.
- **Optically Isolated**
Input Isolated from Output.
- **Zero Cross Switching**
Reduced Current Surges for Most Loads.
- **Internal Snubber**
Excellent Transient Protection.

We're very pleased at the breadth of products and solutions we are able to offer engineers and designers. And this is just the beginning.

We will continue to develop high value products - with innovative features not offered anywhere else in the industry.



70S2 F

- Switch up to 4 Amps
- Solder Terminals
- PCB Mount



70S2 M

- Switch up to 10 Amps
- Solder Terminals
- PCB/Panel Mount



70S2 H

- Switch up to 2.5 Amps
- Solder Terminals
- PCB Mount



70S2 L

- Switch up to 6 Amps
- Solder Terminals
- PCB/Panel Mount



70S2 K

- Switch up to 4 Amps
- Socket Compatible

70S2 Series Solid State Relays/3, 5 Amp, V Style



UL
UL Recognized
File No. E258297

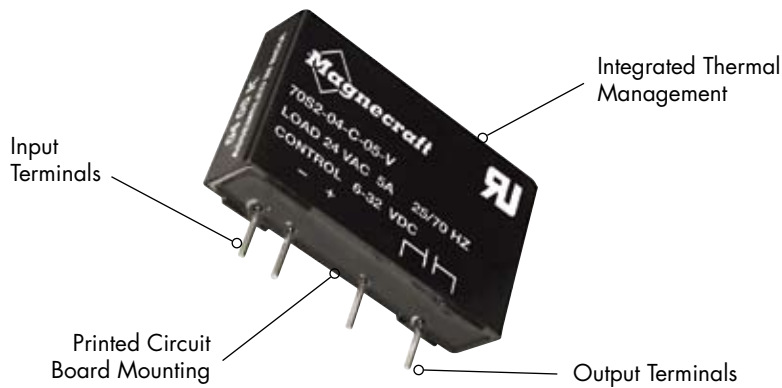

General Specifications (@ 25° C) (UL 508)

Output Characteristics		Units	70S2-04-D	70S2-05-D	70S2-04-B
Number and type of Contacts			SPST-NO	SPST-NO	SPST-NO
Switching Device			Triac	Triac	Triac
Current Rating	A		3 / 5	3	3 / 5
Switching voltage	V		8...50 AC	8...50 AC	24...140 AC
Switching Type			Zero Cross	Zero Cross	Zero Cross
Maximum Rate of Rise Off State Voltage (dv/dt)	V/us		300	300	300
Min. Load current to maintain on	mA		75 / 50	75	75 / 50
Non-Repetitive Surge Current (1 cycle)	A		60 / 300	60	60 / 300
Max. Off state leakage current (rms)	mA		3 / 10	3	6 / 10
Typical On State Voltage Drop (rms)	V		1.6 AC	1.6 AC	1.6 AC
Minimum Peak Blocking Voltage	V		200 AC	200 AC	400 AC
Input Characteristics					
Voltage Range	V		3...32 DC	6...32 DC	3...32 DC
Must Release Voltage	V		1 DC	1 DC	1 DC
Typical Input Current @ 5VDC or 240VAC	mA		1...19	1...6	1...19
Max. Reverse Control Voltage	V		3 DC	3 DC	3 DC
Performance Characteristics					
Operating time (response time)	On	ms	8.3	8.3	8.3
	Off	ms	8.3	8.3	8.3
Dielectric strength	Terminals to Chassis	V	4000 AC	4000 AC	4000 AC
	Input to Output	V	4000 AC	4000 AC	4000 AC
Environment					
Product certifications	Standard version		UR, CSA	UR, CSA	UR, CSA
Ambient air temperature around the device	Storage	°C	-40...+125	-40...+125	-40...+125
	Operation	°C	-40...+100	-40...+100	-40...+100
Miscellaneous Characteristics					
Thermal Resistance (Junction to Case)		°C/W	0.5	0.5	0.5
Weight		g (oz)	25 (0.9)	25 (0.9)	25 (0.9)



70S2 V (3 Amp)



70S2 V (5 Amp)

NEW
NEW
NEW
NEW

70S2-05-B	70S2-04-C	70S2-05-C	70S2-01-A	70S2-02-A
SPST-NO	SPST-NO	SPST-NO	SPST-NO	SPST-NO
Triac	Triac	Triac	MOSFET	MOSFET
3	3 / 5	3	3	3
24....140 AC	24....280 AC	24....280 AC	3....60 DC	3....60 DC
Zero Cross	Zero Cross	Zero Cross	DC Switching	DC Switching
300	300	300	N/A	N/A
75	75 / 50	75	100	100
60	60 / 300	60	5 (1 SEC)	6 (1 SEC)
6	6 / 10	6	10 μ A	10 μ A
1.6 AC	1.6 AC	1.6 AC	1.2 DC	1.2 DC
400 AC	600 AC	600 AC	105 DC	105 DC
6....32 DC	3....32 DC	6....32 DC	3....15 DC	9....30 DC
1 DC	1 DC	1 DC	1 DC	1 DC
1....6	1....19	1....6	5....40	5....17
3 DC	3 DC	3 DC	3 DC	3 DC
8.3	8.3	8.3	75 μ s	75 μ s
8.3	8.3	8.3	500 μ s	500 μ s
4000 AC	4000 AC	4000 AC	4000 AC	4000 AC
4000 AC	4000 AC	4000 AC	4000 AC	4000 AC
UR, CSA	UR, CSA	UR, CSA	UR, CSA	UR, CSA
-40...+125	-40...+125	-40...+125	-40...+125	-40...+125
-40...+100	-40...+100	-40...+100	-40...+100	-40...+100
0.5	0.5	0.5	0.5	0.5
25 (0.9)	25 (0.9)	25 (0.9)	25 (0.9)	25 (0.9)

70S2 Series Solid State Relays/3, 5 Amp, V Style *continued*



UL **us**
UL Recognized
File No. E258297



SECTION 4



70S2 V (3 Amp)



70S2 V (5 Amp)

NEW
NEW
NEW
NEW

Standard Part Numbers

BOLD-FACED PART NUMBERS ARE NORMALLY STOCKED

DC Operated	Input Voltage Range	Output Voltage Range	Contact Configuration	Switching Type	Rated Current Load (Amps)
70S2-04-D-03-V	3...32 VDC	8...50 VAC	SPST-NO	Zero Cross	3
70S2-05-D-03-V	6...32 VDC	8...50 VAC	SPST-NO	Zero Cross	3
70S2-04-D-05-V	3...32 VDC	8...50 VAC	SPST-NO	Zero Cross	5
70S2-04-B-03-V	3...32 VDC	24...140 VAC	SPST-NO	Zero Cross	3
70S2-05-B-03-V	6...32 VDC	24...140 VAC	SPST-NO	Zero Cross	3
70S2-04-B-05-V	3...32 VDC	24...140 VAC	SPST-NO	Zero Cross	5
70S2-04-C-03-V	3...32 VDC	24...280 VAC	SPST-NO	Zero Cross	3
70S2-05-C-03-V	6...32 VDC	24...280 VAC	SPST-NO	Zero Cross	3
70S2-04-C-05-V	3...32 VDC	24...280 VAC	SPST-NO	Zero Cross	5
70S2-01-A-03-V	3...15 VDC	3...60 VDC	SPST-NO	Zero Cross	3
70S2-02-A-03-V	9...30 VDC	3...60 VDC	SPST-NO	Zero Cross	3

Part Number Builder

Series	Input Voltage	Output Voltage	Output Current	Package Style
70S2	01 = 3 to 15 VDC, DC/DC RELAYS	A = 3 to 60 VDC	02 = 2.5 AMPS	V = V STYLE
	02 = 9 to 30 VDC, DC/DC RELAYS	B = 24 to 140 VAC	03 = 3 AMPS	N = N STYLE
	03 = 3 to 30 VDC, 25 A S PACK	C = 24 to 280 VAC	04 = 4 AMPS	S = S STYLE
	04 = 3 to 30 VDC (OR 32 VDC), DC/AC RELAYS	D = 8 to 50 VAC	05 = 5 AMPS	F = F STYLE
	05 = 6 to 30 VDC (OR 32 VDC), DC/AC RELAYS		06 = 6 AMPS	M = M STYLE
			10 = 10 AMPS	H = H STYLE
			12 = 12 AMPS	L = L STYLE
			25 = 25 AMPS	K = K STYLE

Maximum Continuous Current vs. Ambient Temperature

Style V, 3 Amp



Style V, 5 Amp

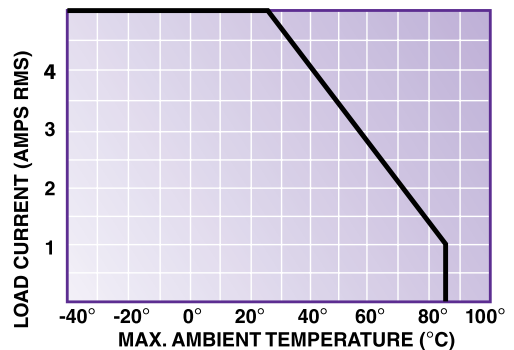

70S2 Series Solid State Relays/N and S Style



General Specifications (@ 25° C) (UL 508)

Output Characteristics		Units	70S2-04-B	70S2-05-B	70S2-04-C
Number and type of Contacts			SPST-NO	SPST-NO	SPST-NO
Switching Device			Triac	Triac	Triac
Current Rating		A	6 / 12	6 / 12	6 / 12
Switching voltage		V	24....140 AC	24....140 AC	24....280 AC
Switching Type			Zero Cross	Zero Cross	Zero Cross
Maximum Rate of Rise Off State Voltage (dv/dt)		V/us	300	300	300
Min. Load current to maintain on		mA	75 / 100	75 / 100	75 / 100
Non-Repetitive Surge Current (1 cycle)		A	60 / 150	60 / 150	60 / 150
Max. Off state leakage current (rms)		mA	6	6	6
Typical On State Voltage Drop (rms)		V	1.6 AC	1.6 AC	1.6 AC
Minimum Peak Blocking Voltage		V	400 AC	400 AC	600 AC
Input Characteristics					
Voltage Range		V	3....30 DC	6....30 DC	3....30 DC
Must Release Voltage		V	1 DC	1 DC	1 DC
Typical Input Current @ 5VDC or 240VAC		mA	7....16	6....10	7....16
Max. Reverse Control Voltage		V	3 DC	3 DC	3 DC
Performance Characteristics					
Operating time (response time)	On	ms	8.3	8.3	8.3
	Off	ms	8.3	8.3	8.3
Dielectric strength	Terminals to Chassis	V	3000 AC	3000 AC	3000 AC
	Input to Output	V	3000 AC	3000 AC	3000 AC
Environment					
Product certifications	Standard version		UR, CSA	UR, CSA	UR, CSA
Ambient air temperature around the device	Storage	°C	-40...+125	-40...+125	-40...+125
	Operation	°C	-40...+100	-40...+100	-40...+100
Miscellaneous Characteristics					
Thermal Resistance (Junction to Case)		°C/W	4	4	4
Weight		g (oz)	47 (1.7)	47 (1.7)	47 (1.7)
Mounting Screw Torque		Nm	1.0	1.0	1.0

Maximum Continuous Current vs. Ambient Temperature





70S2 N



70S2 S

70S2-05-C	70S2-03-B	70S2-03-C	70S2-01-A	70S2-02-A
SPST-NO	SPST-NO	SPST-NO	SPST-NO	SPST-NO
Triac	Triac	Triac	MOSFET	MOSFET
6 / 12	25	25	5	5
24....280 AC	24....140 AC	24....280 AC	3....60 DC	3....60 DC
Zero Cross	Zero Cross	Zero Cross	DC Switching	DC Switching
300	300	300	N/A	N/A
75 / 100	100	100	100	100
60 / 150	300	300	7 (1 SEC)	7 (1 SEC)
6	6	6	10 μ A	10 μ A
1.6 AC	1.7 AC	1.7 AC	1.85 DC	1.85 DC
600 AC	400 AC	600 AC	105 DC	105 DC
6....30 DC	3....30 DC	3....30 DC	3....15 DC	9....30 DC
1 DC	1 DC	1 DC	1 DC	1 DC
6....10	7....16	6....10	5....40	5....17
3 DC	3 DC	3 DC	3 DC	3 DC
8.3	8.3	8.3	75 μs	75 μs
8.3	8.3	8.3	750 μs	750 μs
3000 AC	3000 AC	3000 AC	2500 AC	2500 AC
3000 AC	3000 AC	3000 AC	2500 AC	2500 AC
UR, CSA	UR, CSA	UR, CSA	UR, CSA	UR, CSA
-40...+125	-40...+125	-40...+125	-40...+125	-40...+125
-40...+100	-40...+100	-40...+100	-40...+100	-40...+100
4	4	4	4	4
47 (1.7)	47 (1.7)	47 (1.7)	47 (1.7)	35 (1.2)
1.0	1.0	1.0	1.0	1.0

70S2 Series Solid State Relays/N and S Style *continued*



70S2 S



70S2 N



0.02 (0.5) TERMINALS 0.032 (0.8) TERMINALS

SECTION 4



70S2 N



70S2 S

Standard Part Numbers

BOLD-FACED PART NUMBERS ARE NORMALLY STOCKED

DC Operated	Input Voltage Range	Output Voltage Range	Contact Configuration	Switching Type	Rated Current Load (Amps)
70S2-04-B-06-N	3...30 VDC	24...140 VAC	SPST-NO	Zero Cross	6
70S2-05-B-06-N	6...30 VDC	24...140 VAC	SPST-NO	Zero Cross	6
70S2-04-B-12-N	3...30 VDC	24...140 VAC	SPST-NO	Zero Cross	12
70S2-05-B-12-N	6...30 VDC	24...140 VAC	SPST-NO	Zero Cross	12
70S2-04-C-06-N	3...30 VDC	24...280 VAC	SPST-NO	Zero Cross	6
70S2-05-C-06-N	6...30 VDC	24...280 VAC	SPST-NO	Zero Cross	6
70S2-04-C-12-N	3...30 VDC	24...280 VAC	SPST-NO	Zero Cross	12
70S2-05-C-12-N	6...30 VDC	24...280 VAC	SPST-NO	Zero Cross	12
70S2-01-A-05-N	3...15 VDC	3...60 VDC	SPST-NO	DC Switching	5
70S2-04-B-06-S	3...30 VDC	24...140 VAC	SPST-NO	Zero Cross	6
70S2-05-B-06-S	6...30 VDC	24...140 VAC	SPST-NO	Zero Cross	6
70S2-04-B-12-S	3...30 VDC	24...140 VAC	SPST-NO	Zero Cross	12
70S2-05-B-12-S	6...30 VDC	24...140 VAC	SPST-NO	Zero Cross	12
70S2-03-B-25-S	3...30 VDC	24...140 VAC	SPST-NO	Zero Cross	25
70S2-04-C-06-S	3...30 VDC	24...280 VAC	SPST-NO	Zero Cross	6
70S2-05-C-06-S	6...30 VDC	24...280 VAC	SPST-NO	Zero Cross	6
70S2-04-C-12-S	3...30 VDC	24...280 VAC	SPST-NO	Zero Cross	12
70S2-05-C-12-S	6...30 VDC	24...280 VAC	SPST-NO	Zero Cross	12
70S2-03-C-25-S	3...30 VDC	24...280 VAC	SPST-NO	Zero Cross	25
70S2-01-A-05-S	3...15 VDC	3...60 VDC	SPST-NO	DC Switching	5
70S2-02-A-05-S	9...30 VDC	3...60 VDC	SPST-NO	DC Switching	5

SECTION 4

Part Number Builder

Series	Input Voltage	Output Voltage	Output Current	Package Style
70S2	01 = 3 to 15 VDC, DC/DC RELAYS	A = 3 to 60 VDC	02 = 2.5 AMPS	V = V STYLE
	02 = 9 to 30 VDC, DC/DC RELAYS	B = 24 to 140 VAC	03 = 3 AMPS	N = N STYLE
	03 = 3 to 30 VDC, 25 A S PACK	C = 24 to 280 VAC	04 = 4 AMPS	S = S STYLE
	04 = 3 to 30 VDC (OR 32 VDC), DC/AC RELAYS	D = 8 to 50 VAC	05 = 5 AMPS	F = F STYLE
	05 = 6 to 30 VDC (OR 32 VDC), DC/AC RELAYS		06 = 6 AMPS	M = M STYLE
			10 = 10 AMPS	H = H STYLE
			12 = 12 AMPS	L = L STYLE
			25 = 25 AMPS	K = K STYLE

70S2 Series Solid State Relays/F and M Style



UL Recognized
File No. E258297

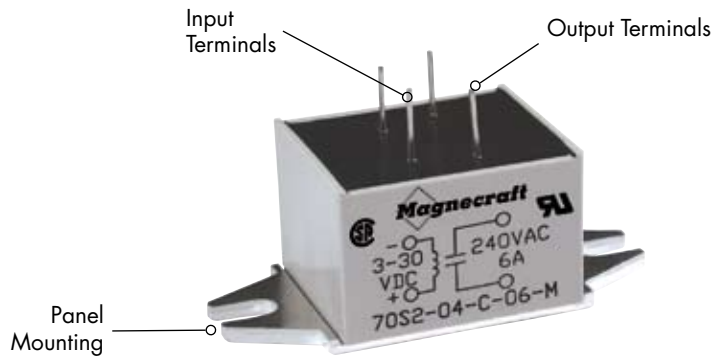

General Specifications (@ 25° C) (UL 508)

Output Characteristics		Units	70S2-04-B	70S2-05-B
Number and type of Contacts			SPST-NO	SPST-NO
Switching Device			Triac	Triac
Current Rating		A	4 6 10	4 6 10
Switching voltage		V	24....140 AC	24....140 AC
Switching Type			Zero Cross	Zero Cross
Maximum Rate of Rise Off State Voltage (dv/dt)		V/us	300	300
Min. Load current to maintain on		mA	75 100	75 100
Non-Repetitive Surge Current (1 cycle)		A	60 110	60 110
Max. Off state leakage current (rms)		mA	6	6
Typical On State Voltage Drop (rms)		V	1.6 AC	1.6 AC
Minimum Peak Blocking Voltage		V	400 AC	400 AC
Input Characteristics				
Voltage Range		V	3....30 DC	6....30 DC
Must Release Voltage		V	1 DC	1 DC
Typical Input Current @ 5VDC or 240VAC		mA	7....16	6....10
Max. Reverse Control Voltage		V	3 DC	3 DC
Performance Characteristics				
Operating time (response time)	On	ms	8.3	8.3
	Off	ms	8.3	8.3
Dielectric strength	Terminals to Chassis	V	3000 AC	3000 AC
	Input to Output	V	3000 AC	3000 AC
Environment				
Product certifications	Standard version		UR, CSA	UR, CSA
Ambient air temperature around the device	Storage	°C	-40...+125	-40...+125
	Operation	°C	-40...+100	-40...+100
Miscellaneous Characteristics				
Thermal Resistance (Junction to Case)		°C/W	4	4
Weight		g (oz)	35 (1.2)	35 (1.2)
Mounting Screw Torque		Nm	1.0	1.0

Maximum Continuous Current vs. Ambient Temperature

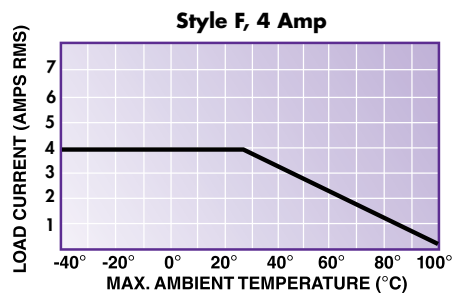
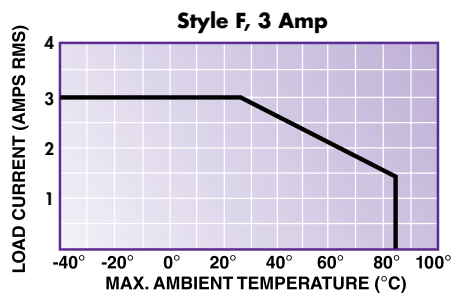



70S2 F



70S2 M

70S2-04-C	70S2-05-C	70S2-01-A	70S2-02-A
SPST-NO	SPST-NO	SPST-NO	SPST-NO
Triac	Triac	MOSFET	MOSFET
4 6 10	4 6 10	3	3
24....280 AC	24....280 AC	3....60 DC	3....60 DC
Zero Cross	Zero Cross	DC Switching	DC Switching
300	300	N/A	N/A
75 100	75 100	100	100
60 110	60 110	N/A	N/A
6	6	10 μ A	10 μ A
1.6 AC	1.6 AC	1.2 DC	1.2 DC
600 AC	600 AC	105 DC	105 DC
3....30 DC	6....30 DC	3....15 DC	9....30 DC
1 DC	1 DC	1 DC	1 DC
7....16	6....10	5....40	5....17
3 DC	3 DC	3 DC	3 DC
8.3	8.3	75 μ s	75 μ s
8.3	8.3	500 μ s	500 μ s
3000 AC	3000 AC	2500 AC	2500 AC
3000 AC	3000 AC	2500 AC	2500 AC
UR, CSA	UR, CSA	UR, CSA	UR, CSA
-40...+125	-40...+125	-40...+125	-40...+125
-40...+100	-40...+100	-40...+100	-40...+100
4	4	4	4
35 (1.2)	35 (1.2)	35 (1.2)	35 (1.2)
1.0	1.0	1.0	1.0

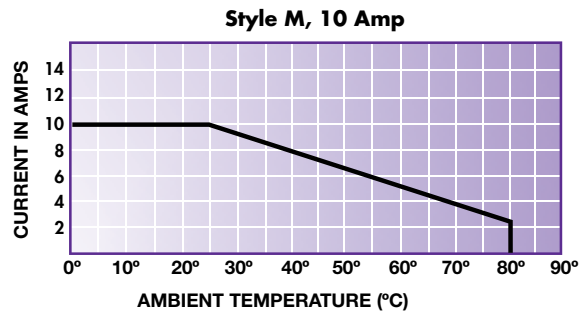
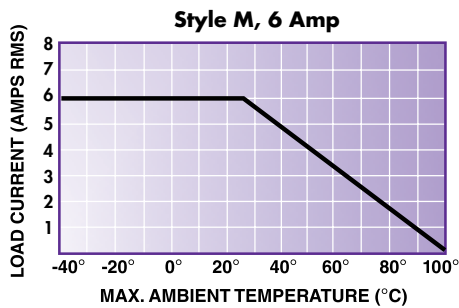

70S2 Series Solid State Relays/F and M Style *continued*

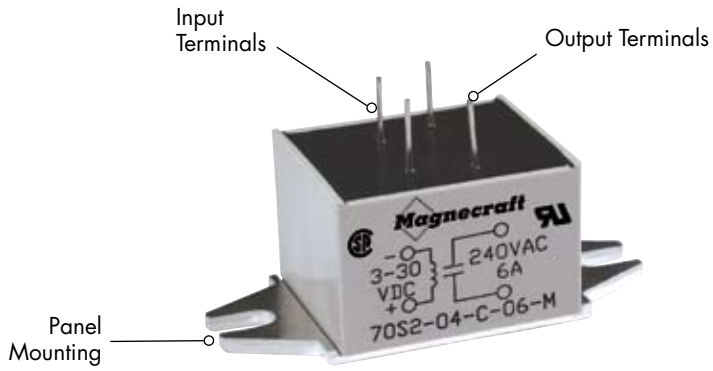

SECTION 4



POTTING MIGRATION ON LEADS

70S2 F



70S2 M

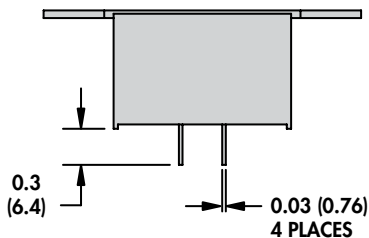
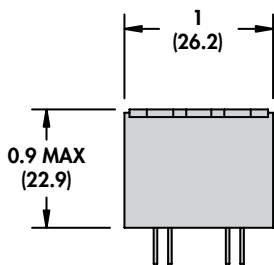



70S2 F



70S2 M

Standard Part Numbers

BOLD-FACED PART NUMBERS ARE NORMALLY STOCKED

DC Operated	Input Voltage Range	Output Voltage Range	Contact Configuration	Switching Type	Rated Current Load (Amps)
70S2-04-B-04-F	3...30 VDC	24...140 VAC	SPST-NO	Zero Cross	4
70S2-05-B-04-F	6...30 VDC	24...140 VAC	SPST-NO	Zero Cross	4
70S2-04-C-04-F	3...30 VDC	24...280 VAC	SPST-NO	Zero Cross	4
70S2-05-C-04-F	6...30 VDC	24...280 VAC	SPST-NO	Zero Cross	4
70S2-01-A-03-F	3...15 VDC	3...60 VDC	SPST-NO	DC Switching	3
70S2-02-A-03-F	9...30 VDC	3...60 VDC	SPST-NO	DC Switching	3
70S2-04-B-06-M	3...30 VDC	24...140 VAC	SPST-NO	Zero Cross	6
70S2-05-B-06-M	6...30 VDC	24...140 VAC	SPST-NO	Zero Cross	6
70S2-04-B-10-M	3...30 VDC	24...140 VAC	SPST-NO	Zero Cross	10
70S2-05-B-10-M	6...30 VDC	24...140 VAC	SPST-NO	Zero Cross	10
70S2-04-C-06-M	3...30 VDC	24...280 VAC	SPST-NO	Zero Cross	6
70S2-05-C-06-M	6...30 VDC	24...280 VAC	SPST-NO	Zero Cross	6
70S2-04-C-10-M	3...30 VDC	24...280 VAC	SPST-NO	Zero Cross	10
70S2-05-C-10-M	6...30 VDC	24...280 VAC	SPST-NO	Zero Cross	10

Part Number Builder

Series	Input Voltage	Output Voltage	Output Current	Package Style
70S2	01 = 3 to 15 VDC, DC/DC RELAYS	A = 3 to 60 VDC	02 = 2.5 AMPS	V = V STYLE
	02 = 9 to 30 VDC, DC/DC RELAYS	B = 24 to 140 VAC	03 = 3 AMPS	N = N STYLE
	03 = 3 to 30 VDC, 25 A S PACK	C = 24 to 280 VAC	04 = 4 AMPS	S = S STYLE
	04 = 3 to 30 VDC (OR 32 VDC), DC/AC RELAYS	D = 8 to 50 VAC	05 = 5 AMPS	F = F STYLE
	05 = 6 to 30 VDC (OR 32 VDC), DC/AC RELAYS		06 = 6 AMPS	M = M STYLE
			10 = 10 AMPS	H = H STYLE
			12 = 12 AMPS	L = L STYLE
			25 = 25 AMPS	K = K STYLE

70S2 Series Solid State Relays/H and L Style



General Specifications (@ 25° C) (UL 508)

Output Characteristics		Units	70S2-04-D	70S2-05-D
Number and type of Contacts			SPST-NO	SPST-NO
Switching Device			Triac	Triac
Current Rating		A	2.5	2.5
Switching voltage		V	8...50 AC	8...50 AC
Switching Type			Zero Cross	Zero Cross
Maximum Rate of Rise Off State Voltage (dv/dt)		V/us	300	300
Min. Load current to maintain on		mA	75	75
Non-Repetitive Surge Current (1 cycle)		A	60	60
Max. Off state leakage current (rms)		mA	3	3
Typical On State Voltage Drop (rms)		V	1.6 AC	1.6 AC
Minimum Peak Blocking Voltage		V	200 AC	200 AC
Input Characteristics				
Voltage Range		V	3...30 DC	6...30 DC
Must Release Voltage		V	1 DC	1 DC
Typical Input Current @ 5VDC or 240VAC		mA	1...17	1...6
Max. Reverse Control Voltage		V	3 DC	3 DC
Performance Characteristics				
Operating time (response time)	On	ms	8.3	8.3
	Off	ms	8.3	8.3
Dielectric strength	Terminals to Chassis	V	2500 AC	2500 AC
	Input to Output	V	2500 AC	2500 AC
Environment				
Product certifications		Standard version	UR, CSA	UR, CSA
Ambient air temperature around the device	Storage	°C	-40...+125	-40...+125
	Operation	°C	-40...+100	-40...+100
Miscellaneous Characteristics				
Thermal Resistance (Junction to Case)		°C/W	3.5	3.5
Weight		g (oz)	22 (0.8)	22 (0.8)
Mounting Screw Torque		Nm	1.0	1.0

Maximum Continuous Current vs. Ambient Temperature





70S2 H



70S2 L

70S2-04-B	70S2-05-B	70S2-04-C	70S2-05-C
SPST-NO	SPST-NO	SPST-NO	SPST-NO
Triac	Triac	Triac	Triac
2.5 6	2.5 6	2.5 6	2.5 6
24....140 AC	24....140 AC	24....280 AC	24....280 AC
Zero Cross	Zero Cross	Zero Cross	Zero Cross
300	300	300	300
75	75	75	75
60	60	60	60
6	6	6	6
1.6 AC	1.6 AC	1.6 AC	1.6 AC
400 AC	400 AC	600 AC	400 AC
3....30 DC	6....30 DC	3....30 DC	6....30 DC
1 DC	1 DC	1 DC	1 DC
1....17	1....6	1....17	1....6
3 DC	3 DC	3 DC	3 DC
8.3	8.3	8.3	8.3
8.3	8.3	8.3	8.3
2500 AC	2500 AC	2500 AC	2500 AC
2500 AC	2500 AC	2500 AC	2500 AC
UR, CSA	UR, CSA	UR, CSA	UR, CSA
-40...+125	-40...+125	-40...+125	-40...+125
-40...+100	-40...+100	-40...+100	-40...+100
3.5	3.5	3.5	3.5
22 (0.8)	22 (0.8)	22 (0.8)	22 (0.8)
1.0	1.0	1.0	1.0

70S2 Series Solid State Relays/H and L Style *continued*

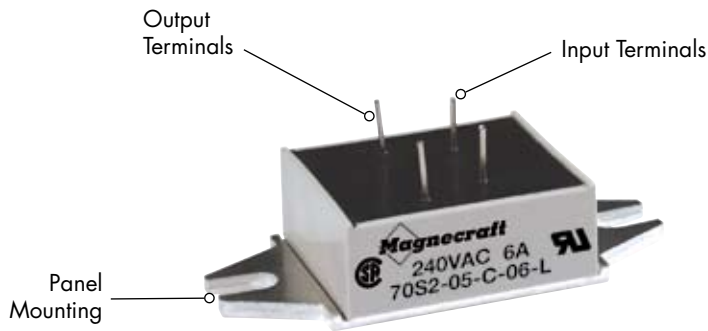

SECTION 4

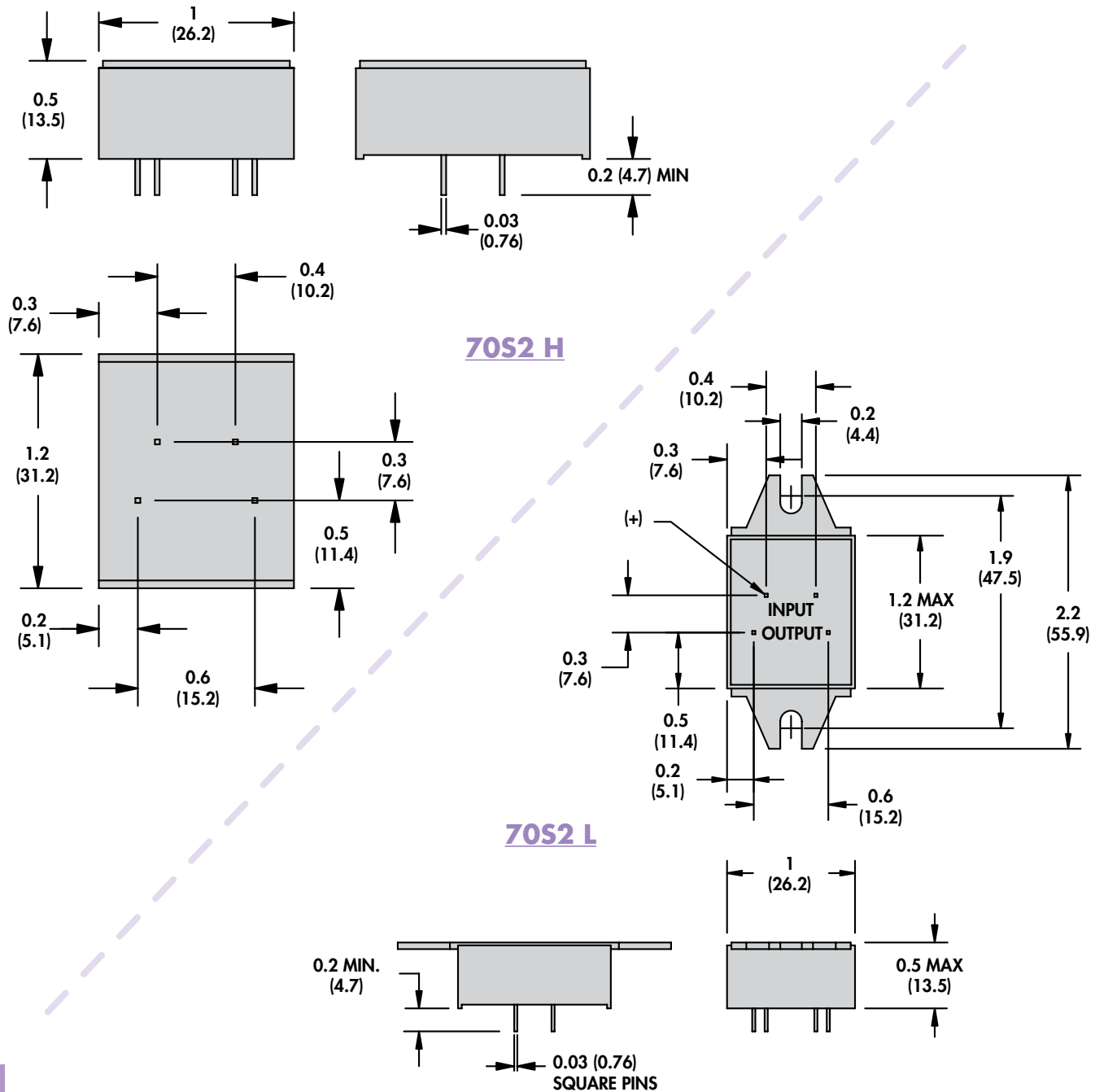



70S2 H



70S2 L

Standard Part Numbers

BOLD-FACED PART NUMBERS ARE NORMALLY STOCKED

DC Operated	Input Voltage Range	Output Voltage Range	Contact Configuration	Switching Type	Rated Current Load (Amps)
70S2-04-D-02-H	3....30 VDC	8....50 VAC	SPST-NO	Zero Cross	2.5
70S2-05-D-02-H	6....30 VDC	8....50 VAC	SPST-NO	Zero Cross	2.5
70S2-04-B-02-H	3....30 VDC	24....140 VAC	SPST-NO	Zero Cross	2.5
70S2-05-B-02-H	6....30 VDC	24....140 VAC	SPST-NO	Zero Cross	2.5
70S2-04-C-02-H	3....30 VDC	24....280 VAC	SPST-NO	Zero Cross	2.5
70S2-05-C-02-H	6....30 VDC	24....280 VAC	SPST-NO	Zero Cross	2.5
70S2-04-B-06-L	3....30 VDC	24....140 VAC	SPST-NO	Zero Cross	6
70S2-05-B-06-L	6....30 VDC	24....140 VAC	SPST-NO	Zero Cross	6
70S2-04-C-06-L	3....30 VDC	24....280 VAC	SPST-NO	Zero Cross	6
70S2-05-C-06-L	6....30 VDC	24....280 VAC	SPST-NO	Zero Cross	6

SECTION 4

Part Number Builder

Series	Input Voltage	Output Voltage	Output Current	Package Style
70S2	01 = 3 to 15 VDC, DC/DC RELAYS	A = 3 to 60 VDC	02 = 2.5 AMPS	V = V STYLE
	02 = 9 to 30 VDC, DC/DC RELAYS	B = 24 to 140 VAC	03 = 3 AMPS	N = N STYLE
	03 = 3 to 30 VDC, 25 A S PACK	C = 24 to 280 VAC	04 = 4 AMPS	S = S STYLE
	04 = 3 to 30 VDC (OR 32 VDC), DC/AC RELAYS	D = 8 to 50 VAC	05 = 5 AMPS	F = F STYLE
	05 = 6 to 30 VDC (OR 32 VDC), DC/AC RELAYS		06 = 6 AMPS	M = M STYLE
			10 = 10 AMPS	H = H STYLE
			12 = 12 AMPS	L = L STYLE
			25 = 25 AMPS	K = K STYLE

70S2 Series Solid State Relays/K Style



UL US
UL Recognized
File No. E258297



General Specifications (@ 25° C) (UL 508)

Output Characteristics		Units	70S2-04-B	70S2-04-C
Number and type of Contacts			SPST-NO	SPST-NO
Switching Device			Triac	Triac
Current Rating		A	4	4
Switching voltage		V	24....140 AC	24....280 AC
Switching Type			Zero Cross	Zero Cross
Maximum Rate of Rise Off State Voltage (dv/dt)		V/us	300	300
Min. Load current to maintain on		mA	75	75
Non-Repetitive Surge Current (1 cycle)		A	60	60
Max. Off state leakage current (rms)		mA	6	6
Typical On State Voltage Drop (rms)		V	1.6	1.6
Minimum Peak Blocking Voltage		V	400 AC	600 AC
Input Characteristics				
Voltage Range		V	3....30 DC	3....30 DC
Must Release Voltage		V	1 DC	1 DC
Typical Input Current @ 5VDC or 240VAC		mA	1....17	1....6
Max. Reverse Control Voltage		V	5 DC	5 DC
Performance Characteristics				
Operating time (response time)	On	ms	8.3	8.3
	Off	ms	8.3	8.3
Dielectric strength	Terminals to Chassis	V	3000 AC	3000 AC
	Input to Output	V	3000 AC	3000 AC
Environment				
Product certifications		Standard version	UR, CSA	UR, CSA
Ambient air temperature around the device	Storage	°C	-40...+125	-40...+125
	Operation	°C	-40...+100	-40...+100
Miscellaneous Characteristics				
Thermal Resistance (Junction to Case)		°C/W	1.5	1.5
Weight		g (oz)	40 (1.4)	40 (1.4)

Maximum Continuous Current vs. Ambient Temperature





70S2 K Relay with the 70-459-1 Socket



70S2 K

70S2-04-D	70S2-05-B	70S2-05-C	70S2-05-D	70S2-01-A	70S2-02-A
SPST-NO	SPST-NO	SPST-NO	SPST-NO	SPST-NO	SPST-NO
Triac	Triac	Triac	Triac	MOSFET	MOSFET
4	4	4	4	3	3
8....50 AC	24....140 AC	24....280 AC	8....50 AC	3....60 DC	3....60 DC
Zero Cross	Zero Cross	Zero Cross	Zero Cross	DC Switching	DC Switching
300	300	300	300	N/A	N/A
75	75	75	75	100	100
60	60	60	60	7 (1 SEC)	7 (1 SEC)
3	6	6	6	10 μ A	10 μ A
1.6	1.6	1.6	1.6	1.2	1.2
200 AC	400 AC	600 AC	200 AC	105 DC	105 DC
3....30 DC	6....30 DC	6....30 DC	6....30 DC	3....15	9....30
1 DC	1 DC	1 DC	1 DC	1 DC	1 DC
1....17	1....6	1....17	1....6	5....40	5....17
5 DC	5 DC	5 DC	5 DC	5 DC	5 DC
8.3	8.3	8.3	8.3	75 μ s	75 μ s
8.3	8.3	8.3	8.3	500 μ s	500 μ s
3000 AC	3000 AC	3000 AC	3000 AC	3000 AC	3000 AC
3000 AC	3000 AC	3000 AC	3000 AC	3000 AC	3000 AC
UR, CSA	UR, CSA	UR, CSA	UR, CSA	UR, CSA	UR, CSA
-40...+125	-40...+125	-40...+125	-40...+125	-40...+125	-40...+125
-40...+100	-40...+100	-40...+100	-40...+100	-40...+100	-40...+100
1.5	1.5	1.5	1.5	1.5	1.5
40 (1.4)	40 (1.4)	40 (1.4)	40 (1.4)	40 (1.4)	40 (1.4)

70S2 Series Solid State Relays/K Style *continued*



SECTION 4

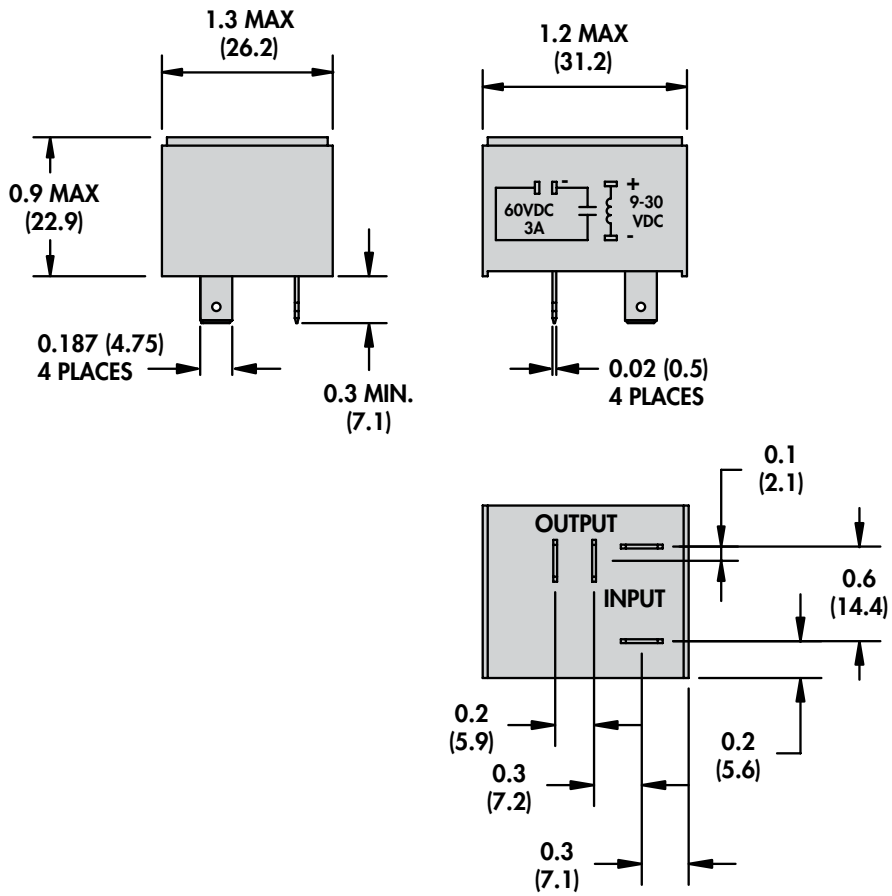

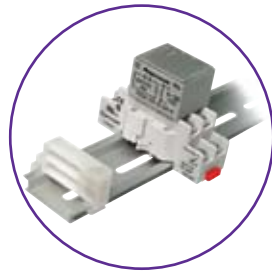

70S2 K Relay with the 70-459-1 Socket



70S2 K

Standard Part Numbers

BOLD-FACED PART NUMBERS ARE NORMALLY STOCKED

DC Operated	Input Voltage Range	Output Voltage Range	Contact Configuration	Switching Type	Rated Current Load (Amps)
70S2-04-B-04-K	3....30 VDC	24....140 VAC	SPST-NO	Zero Cross	4
70S2-04-C-04-K	3....30 VDC	24....280 VAC	SPST-NO	Zero Cross	4
70S2-04-D-04-K	3....30 VDC	8....50 VAC	SPST-NO	Zero Cross	4
70S2-05-B-04-K	6....30 VDC	24....140 VAC	SPST-NO	Zero Cross	4
70S2-05-C-04-K	6....30 VDC	24....280 VAC	SPST-NO	Zero Cross	4
70S2-05-D-04-K	6....30 VDC	8....50 VAC	SPST-NO	Zero Cross	4
70S2-01-A-03-K	3....15 VDC	3....60 VDC	SPST-NO	DC Switching	3
70S2-02-A-03-K	9....30 VDC	3....60 VDC	SPST-NO	DC Switching	3

Part Number Builder

Series	Input Voltage	Output Voltage	Output Current	Package Style
70S2	01 = 3 to 15 VDC, DC/DC RELAYS	A = 3 to 60 VDC	02 = 2.5 AMPS	V = V STYLE
	02 = 9 to 30 VDC, DC/DC RELAYS	B = 24 to 140 VAC	03 = 3 AMPS	N = N STYLE
	03 = 3 to 30 VDC, 25 A S PACK	C = 24 to 280 VAC	04 = 4 AMPS	S = S STYLE
	04 = 3 to 30 VDC (OR 32 VDC), DC/AC RELAYS	D = 8 to 50 VAC	05 = 5 AMPS	F = F STYLE
	05 = 6 to 30 VDC (OR 32 VDC), DC/AC RELAYS		06 = 6 AMPS	M = M STYLE
			10 = 10 AMPS	H = H STYLE
			12 = 12 AMPS	L = L STYLE
			25 = 25 AMPS	K = K STYLE

Компания «Океан Электроники» предлагает заключение долгосрочных отношений при поставках импортных электронных компонентов на взаимовыгодных условиях!

Наши преимущества:

- Поставка оригинальных импортных электронных компонентов напрямую с производств Америки, Европы и Азии, а так же с крупнейших складов мира;
- Широкая линейка поставок активных и пассивных импортных электронных компонентов (более 30 млн. наименований);
- Поставка сложных, дефицитных, либо снятых с производства позиций;
- Оперативные сроки поставки под заказ (от 5 рабочих дней);
- Экспресс доставка в любую точку России;
- Помощь Конструкторского Отдела и консультации квалифицированных инженеров;
- Техническая поддержка проекта, помощь в подборе аналогов, поставка прототипов;
- Поставка электронных компонентов под контролем ВП;
- Система менеджмента качества сертифицирована по Международному стандарту ISO 9001;
- При необходимости вся продукция военного и аэрокосмического назначения проходит испытания и сертификацию в лаборатории (по согласованию с заказчиком);
- Поставка специализированных компонентов военного и аэрокосмического уровня качества (Xilinx, Altera, Analog Devices, Intersil, Interpoint, Microsemi, Actel, Aeroflex, Peregrine, VPT, Syfer, Eurofarad, Texas Instruments, MS Kennedy, Miteq, Cobham, E2V, MA-COM, Hittite, Mini-Circuits, General Dynamics и др.);

Компания «Океан Электроники» является официальным дистрибьютором и эксклюзивным представителем в России одного из крупнейших производителей разъемов военного и аэрокосмического назначения «JONHON», а так же официальным дистрибьютором и эксклюзивным представителем в России производителя высокотехнологичных и надежных решений для передачи СВЧ сигналов «FORSTAR».



JONHON

«JONHON» (основан в 1970 г.)

Разъемы специального, военного и аэрокосмического назначения:

(Применяются в военной, авиационной, аэрокосмической, морской, железнодорожной, горно- и нефтедобывающей отраслях промышленности)

«FORSTAR» (основан в 1998 г.)

ВЧ соединители, коаксиальные кабели, кабельные сборки и микроволновые компоненты:

(Применяются в телекоммуникациях гражданского и специального назначения, в средствах связи, РЛС, а так же военной, авиационной и аэрокосмической отраслях промышленности).



Телефон: 8 (812) 309-75-97 (многоканальный)

Факс: 8 (812) 320-03-32

Электронная почта: ocean@oceanchips.ru

Web: <http://oceanchips.ru/>

Адрес: 198099, г. Санкт-Петербург, ул. Калинина, д. 2, корп. 4, лит. А