

ACT4911EVK1-301 User's Guide

Description

This document describes the characteristic and operation of the Active Semi ACT4911EVK1QW301 evaluation kit (EVK). It provides setup and operation instructions, schematic, layout, BOM, and test data. This EVK demonstrates the ACT4911QW301 eFuse power management IC. Other ACT4911QWxxx options can be evaluated on this EVK by replacing the IC and any other necessary components.

Features

The EVK can be used as a standalone board if desired. However, to access the internal registers and to take full advantage of the IC's capability, the user must connect the EVK kit to a PC with Active Semi's USB-TO-I2C interface dongle and use the GUI software. The EVK provides full access to the each converter's input and output voltage, as well as all the digital control signals. This gives the user the flexibility to configure the EVK to match their real world system. Note that the ACT4911EVK1-301 is specifically configured for the ACT4911QW301 IC.

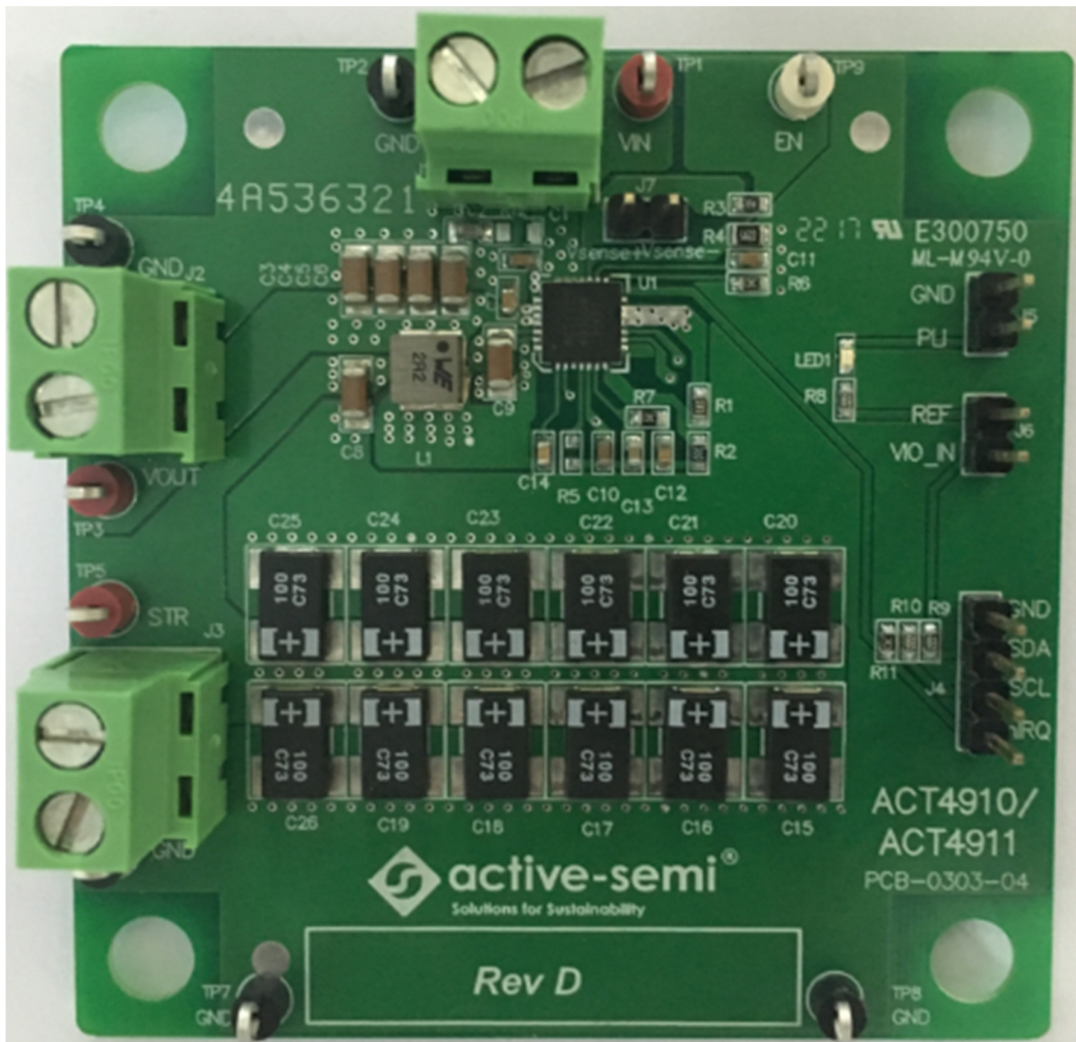

Figure 1 – EVK Picture

Setup

Required Equipment

ACT4911 EVK

USB-TO-I2C Dongle

Power supply – 3.3V @ 5A for full power operation

Oscilloscope – >100MHz, >2 channels

Loads – Electronic or resistive. 4A minimum current capability.

Digital Multimeters (DMM)

Windows compatible computer with spare USB port.

EVK Setup

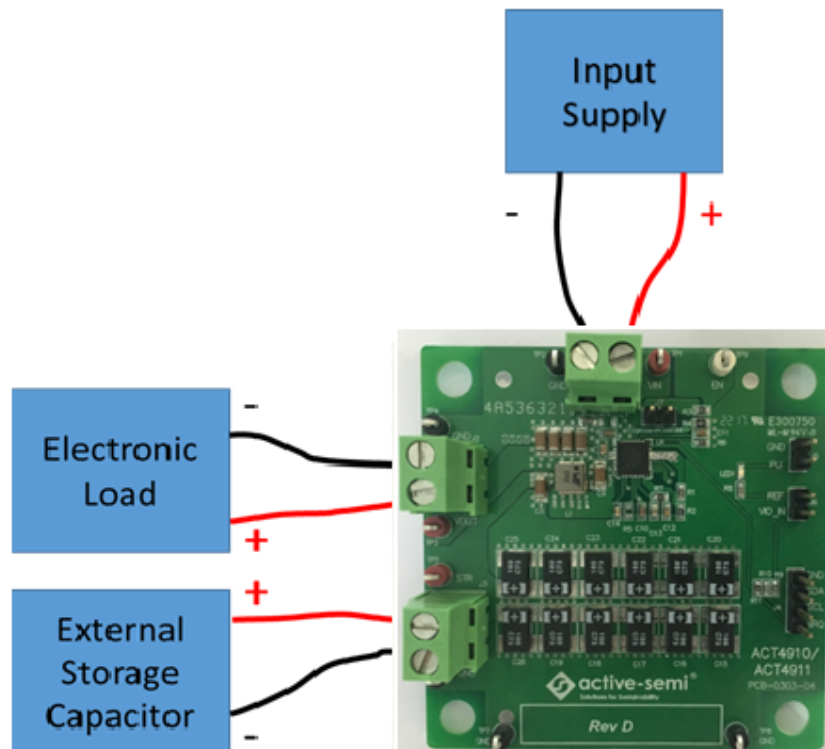

Figure 2 – EVK Setup

Hardware Setup

1. If using I2C, ensure that a shorting jumper is placed across J6 to provide a pullup voltage.
2. Connect a lab supply to J1.
3. Connect an appropriate load to J2.

GUI Setup (optional)

1. Refer to the end of this document for detailed instructions to install the ACT4911 GUI.
2. Connect the USB-TO-I2C dongle to the computer via a USB cable.
3. Connect the USB-TO-I2C dongle to the EVK J4 connector. Refer to Figure 3 to ensure the correct polarity of the connection. As a guide, use the “Active-Semi” logo on the top of the dongle so the black wire is connected toward the lower left corner of the Dongle.

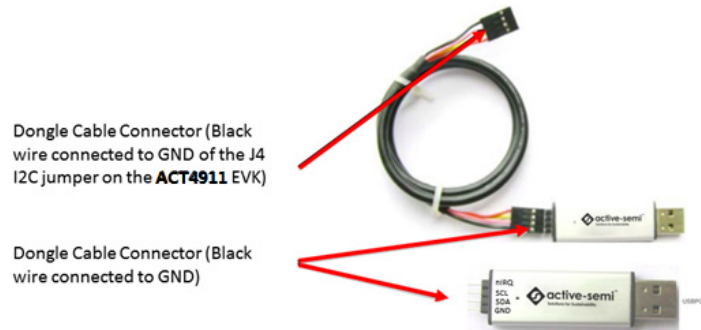

Figure 3 – USB-TO-I2C Dongle Connection

EVK Design Parameters

The ACT4911EVK1-301 is designed for a 3.3V input voltage. The maximum operating voltage is determined by the IC's maximum input voltage rating. The minimum operating voltages are determined by the buck converters' minimum input voltage and by the LDOs' dropout voltages. Maximum currents are determined by the IC's CMI settings, which can be changed via I2C after startup.

Table 1. EVK Design Parameters

Parameter	Description	Min	Typ	Max	Unit
V _{IN}	eFuse input voltage		3.3		V
I _{OUT}	Load current		2		A
I _{CL}	eFuse current limit		3.5		A
V _{STR}	Storage voltage		12		V
EN_UV	Input voltage falling threshold to start supplement mode		3.05		
V _{Buck}	Buck output voltage in supplement mode		3.15		
T _{softstart}	Softstart time		20		ms
T _{holdup}	Supplement mode holdup time		3		ms

Jumpers and Connectors

J1 – Input voltage to the EVK.

J2 – Output power from the EVK. This is the system load.

J3 – Additional storage capacitor connector. This connector allows additional storage capacitors to be easily added for evaluation

J4 – I2C connector. Connect to the Active Semi USB-TO-GPIO dongle or to any other I2C communication device.

J5 – PLI output. This allows easy access the PLI or PG_STR pin.

J6 – I2C pullup voltage source. Place a shorting jumper across J6 to pullup the I2C lines to the IC REF voltage. An external voltage may be applied to J6-2 if desired.

J7 – eFuse R_{dson} measurement. This connector provides easy to access Kelvin connections to measure the eFuse R_{dson}. Do not use J7 to apply power to the EVK or as an output connector for the load.

EVK Operation

Turn on

The EVK is preconfigured and ready to use. Apply the 3.3V input voltage and the EVK automatically powers, charges the storage capacitors, and delivers power to the load. No modifications are needed to start evaluating the ACT4911's many functions such as supplement mode, ADC measurements, current limiting, etc.

Modifications

The EVK is designed to allow the user to immediately start evaluating the ACT4911 functionality. After the user becomes familiar with the EVK functionality and has verified that they can reproduce the performance data, they can easily modify the EVK to match their specific system level requirements. Refer to the ACT4911 datasheet for detailed design equations.

PLI vs PG_STR Functionality

The ACT4911 default setting for pin 2 is for the PLI functionality. If the user changes this functionality to the PG_STR function, populate R8 with a 2.2kohm resistor to enable LED1 to turn on when PG_STR goes low.

Input Snubber

The EVK contains a non-populated input snubber. If testing with long, inductive cables, populating the snubber with the appropriate values will reduce overshoot when the input is hot plugged. 1nF and 10Ω are good starting points.

Test Results

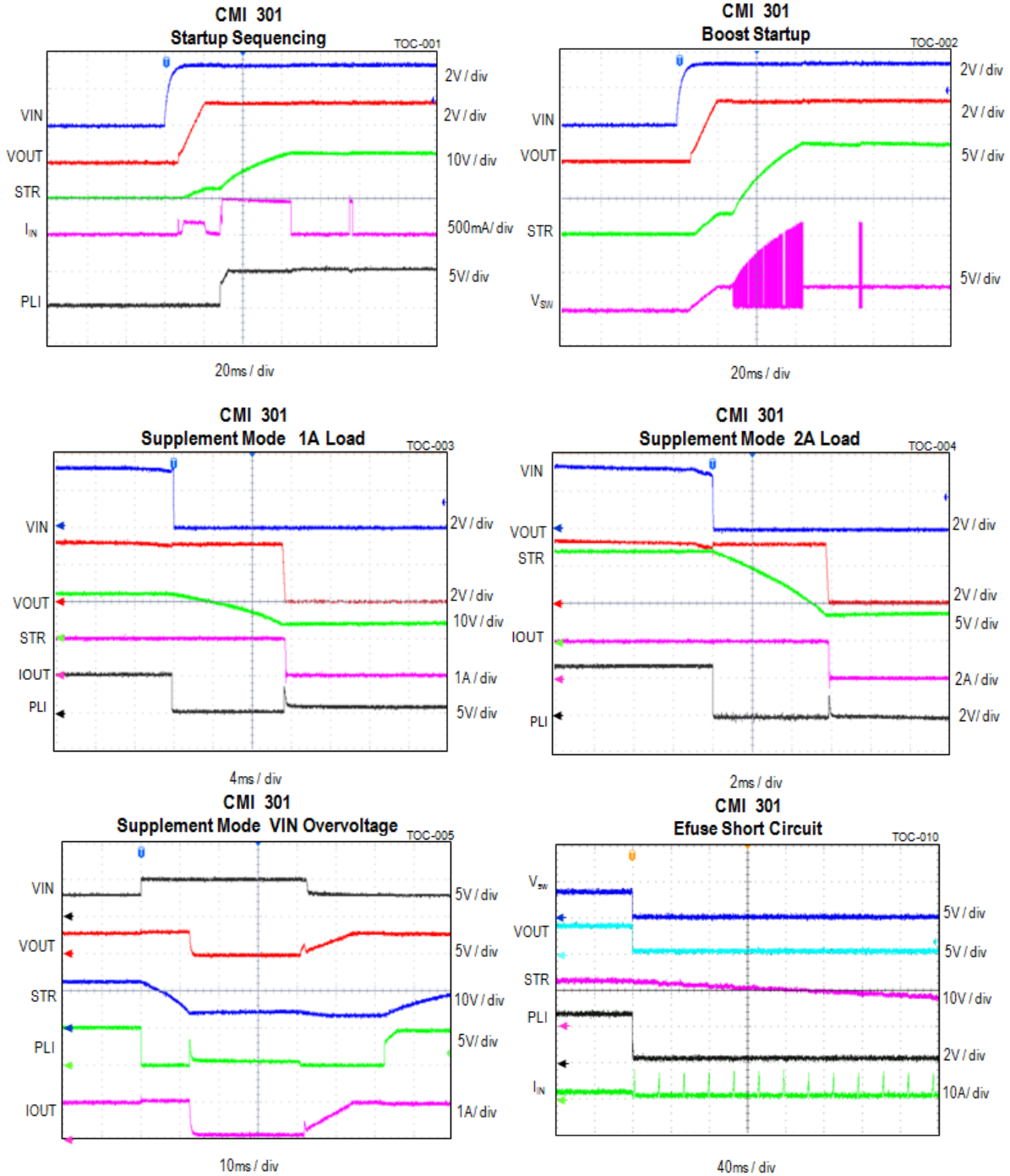

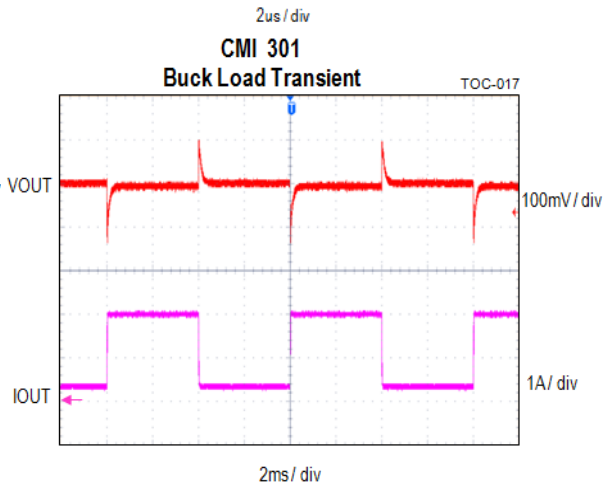
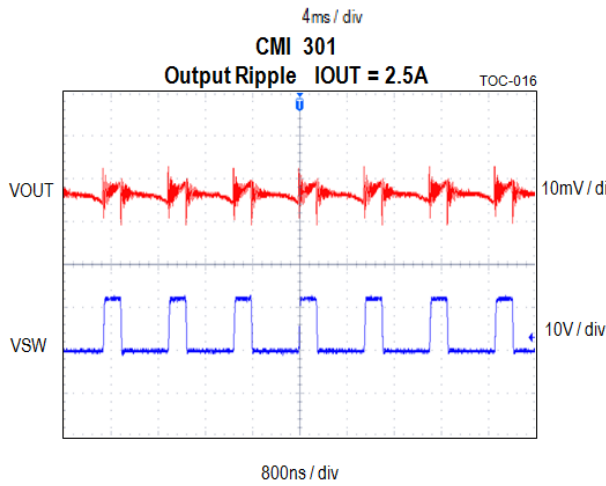
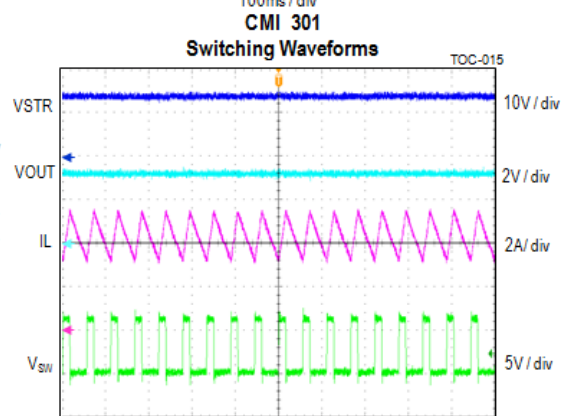
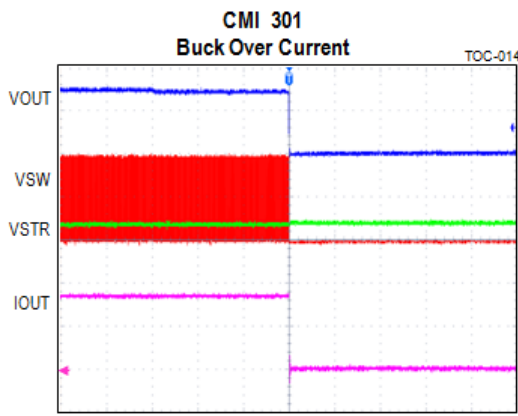
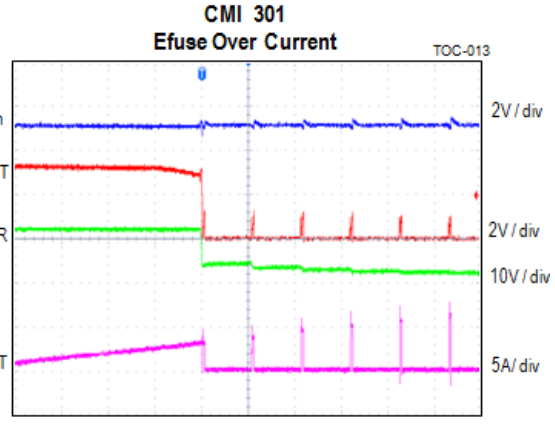
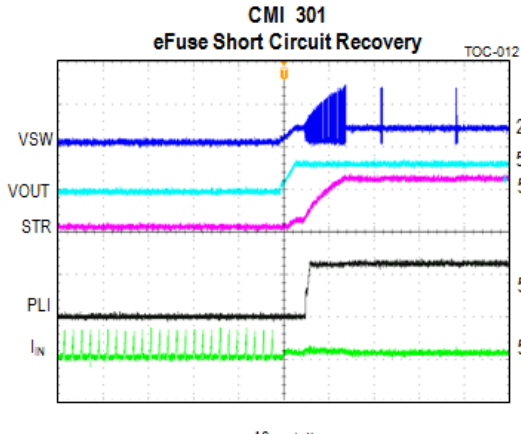

**CMI 301
Supplement Mode Efficiency**

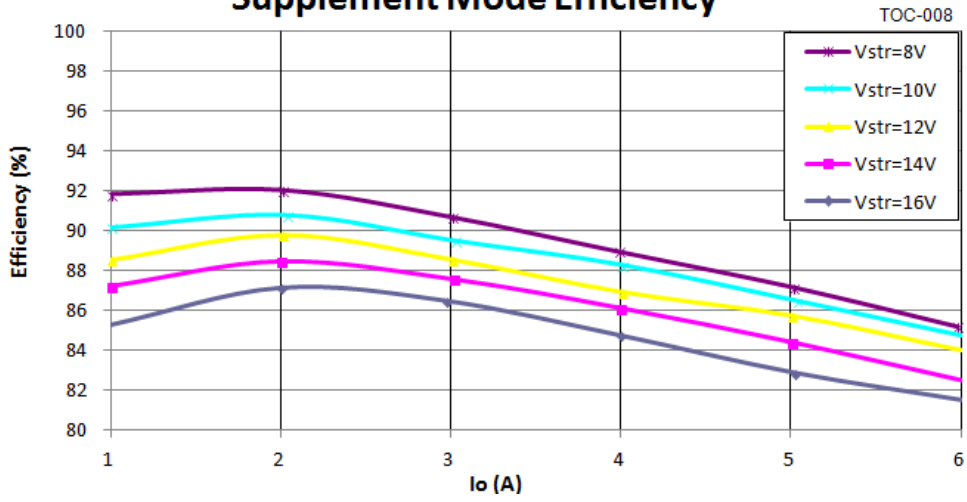

**CMI 301
Supplement Mode Efficiency**

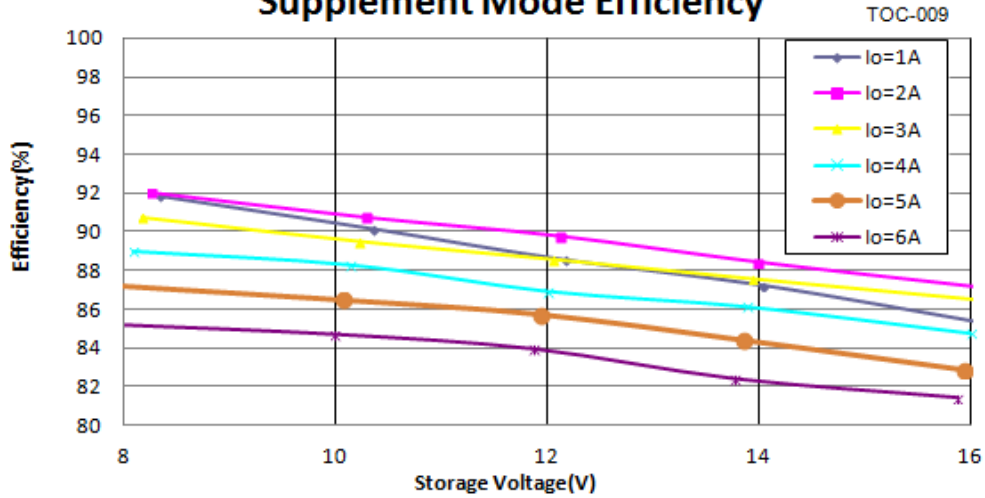

Schematic

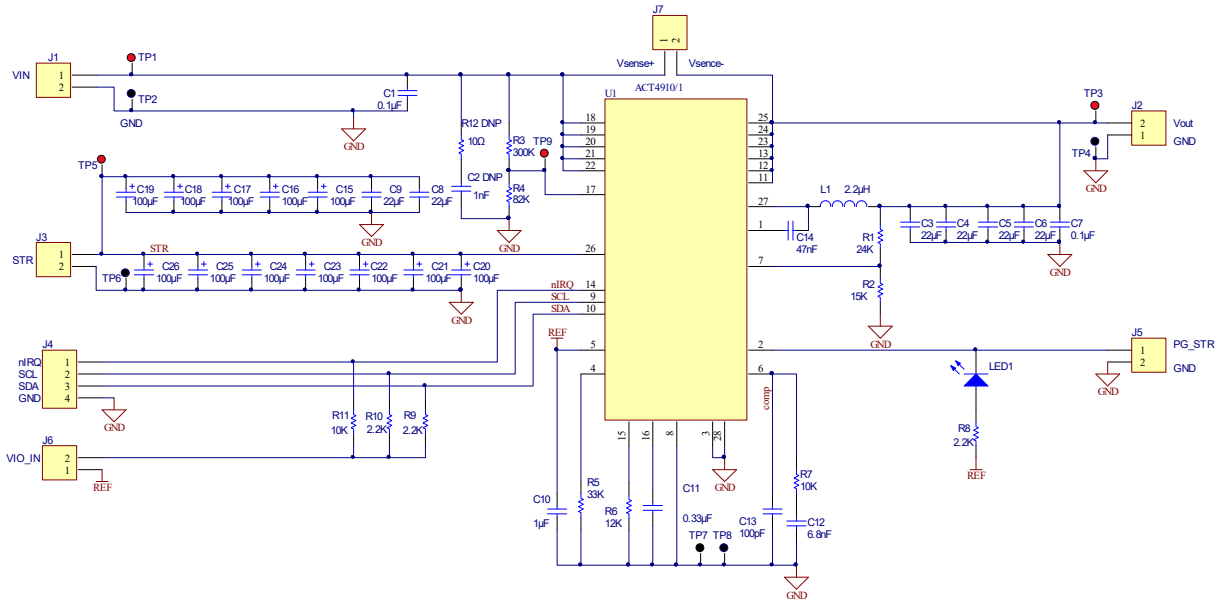

Figure 4 – ACT4911EVK1-301 Schematic

Layout

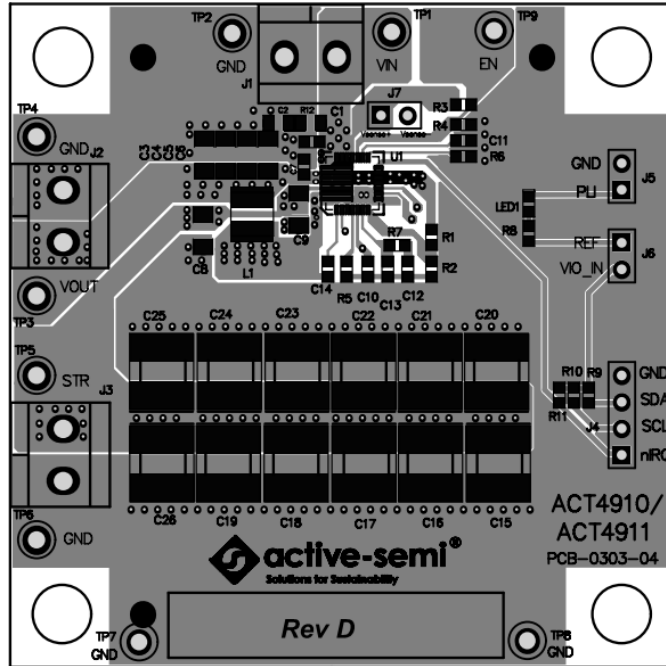

Figure 5 – Layout Top Layer

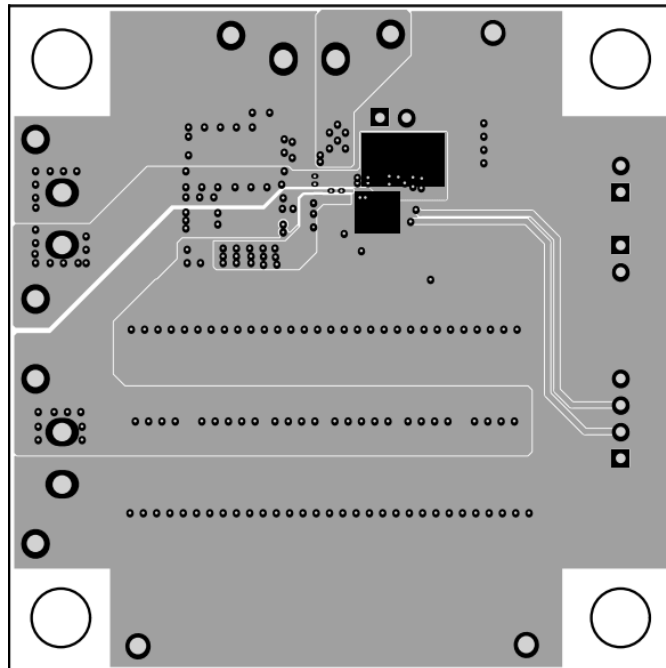

Figure 6 – Layout Bottom Layer

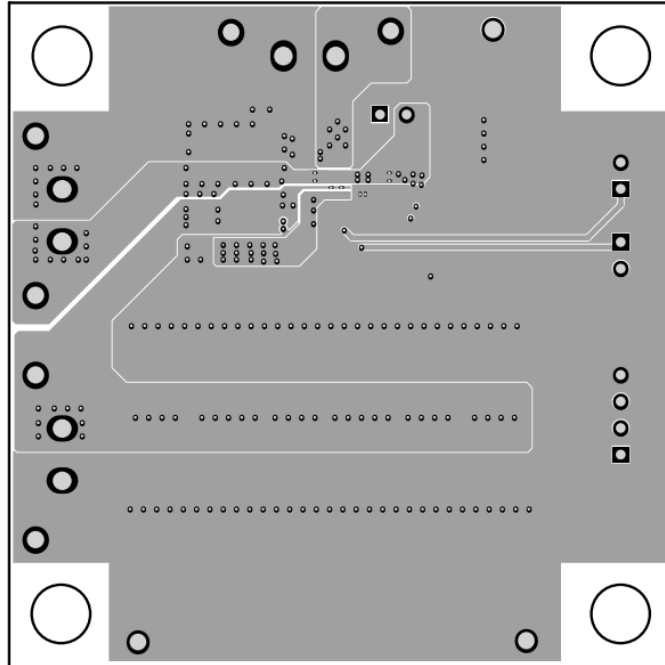

Figure 7 – Layout Power

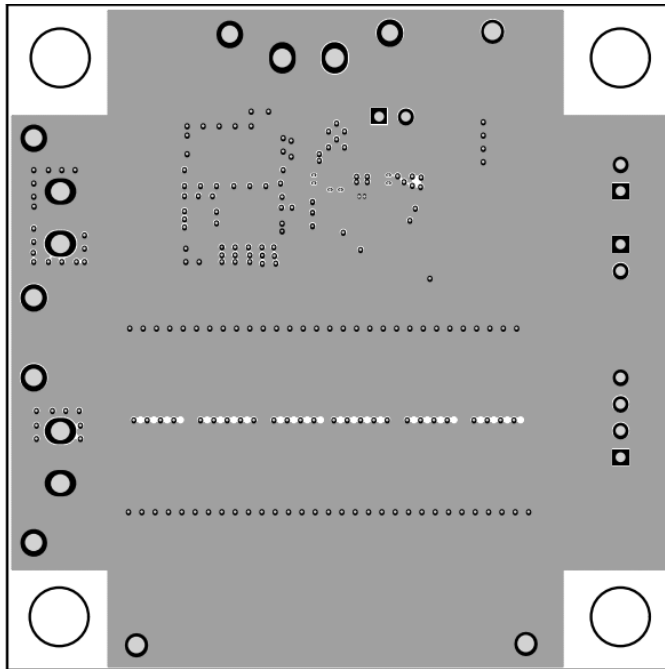

Figure 8 – Layout GND

Bill of Materials

Item	Ref Des	QTY	Description	Package	MFR	Part Number
1	C1	2	Cap, Ceramic, 0.1uF, 50V, 10%, X7R	603	Std	Std
2	C2	1	Cap, Ceramic, 1nF, 50V, 10%, X7R	603	Std	Std
3	C3, C4, C5, C6	4	Cap, Ceramic, 22uF, 16V, 10%, X7R	1206	Std	Std
4	C7	1	Cap, Ceramic, 0.1uF, 50V, 10%, X7R	603	Std	Std
5	C8, C9	2	Cap, Ceramic, 22uF, 50V, 10%, X7R	1206	Std	Std
6	C10	1	Cap, Ceramic, 1uF, 16V, 10%, X7R	603	Std	Std
7	C11	1	Cap, Ceramic, 330nF, 50V, 10%, X7R	603	Std	Std
8	C12	1	Cap, Ceramic, 6800pF, 16V, 10%, X7R	603	Std	Std
9	C13	1	Cap, Ceramic, 100pF, 16V, 10%, X7R	603	Std	Std
10	C14	1	Cap, Ceramic, 47nF, 25V, 10%, X7R	603	Std	Std
11	C15, C16, C17, C18, C19, C20, C21, C22, C23, C24, C25, C26	12	Cap, Ceramic, 100uF/16V, 10%, X7R	D7343	Kemet	1605S70CB
12	L1	1	Inductor, 2.2uH, 6A, 3.15mohm, SMD Flat Wire High Current	7x7x4.8mm	Würth Elektronik	74438357022
13	LED1	1	LED, Bright Green	603	Würth Elektronik	150060V575000
14	R1	1	Res, 24kΩ, 1%	603	Std	Std
15	R2	1	Res, 15kΩ, 1%	603	Std	Std
16	R3	1	Res, 300kΩ, 1%	603	Std	Std
17	R4	1	Res, 82kΩ, 1%	603	Std	Std
18	R5	1	Res, 33kΩ, 1%	603	Std	Std
19	R6	1	Res, 10kΩ, 1%	603	Std	Std
20	R7	1	Res, 10kΩ, 5%	603	Std	Std
21	R8, R9, R10	3	Res, 2.2KΩ, 5%,	603	Std	Std
22	R11	1	Res, 10KΩ, 5%	603	Std	Std
23	R12	1	Res, 10Ω, 5%	603	Std	Std
24	J1, J2, J3	3	Header, Series 213 - 5mm horizontal entry	5mm	Würth Elektronik	691213710002
25	J4	1	Header, 4 pin, 100mil		Würth Elektronik	61300411121
26	J5, J6	2	Header, 2 pin, 100mil		Würth Elektronik	61300211121
27	TP1, TP3, TP5	3	Test Point, Red, Through Hole, 1mm	0.040"	Keystone	5000
28	TP2, TP4, TP6, TP7, TP8	5	Test Point, Black, Through Hole, 1mm	0.040"	Keystone	5001
29	U1	1	ACT4911CMI-301-REVE,	QFN28	Active-semi	

GUI Installation

1. Contact Active Semi for the GUI files and save them on your computer.
2. Plug the USB-TO-I2C dongle into a free USB port.
3. Follow the instructions in the “How to install driver for dongle” folder.

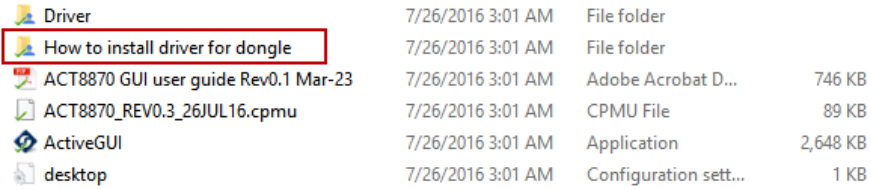







 Driver	7/26/2016 3:01 AM	File folder	
 How to install driver for dongle	7/26/2016 3:01 AM	File folder	
 ACT8870 GUI user guide Rev0.1 Mar-23	7/26/2016 3:01 AM	Adobe Acrobat D...	746 KB
 ACT8870_REV0.3_26JUL16.cpmu	7/26/2016 3:01 AM	CPMU File	89 KB
 ActiveGUI	7/26/2016 3:01 AM	Application	2,648 KB
 desktop	7/26/2016 3:01 AM	Configuration sett...	1 KB

Figure 9 – Dongle Driver

4. Double click on the ACT4911 GUI.exe to start the ACT4911 GUI.

GUI Overview

The GUI has 2 basic function buttons allocated in top-left of the Tool Bar which are Read and Write I2C. The GUI contains 2 setting modes: Basic Mode and Advanced Mode. In Basic Mode screen it displays basic user programmable configuration options are programmed using the drop-down boxes or check boxes. Advanced Mode contain the button text for changing setting for every single bit.

Basic Mode

The following figure show the GUI in basic mode. This mode allows the user to easily change one or more IC settings.

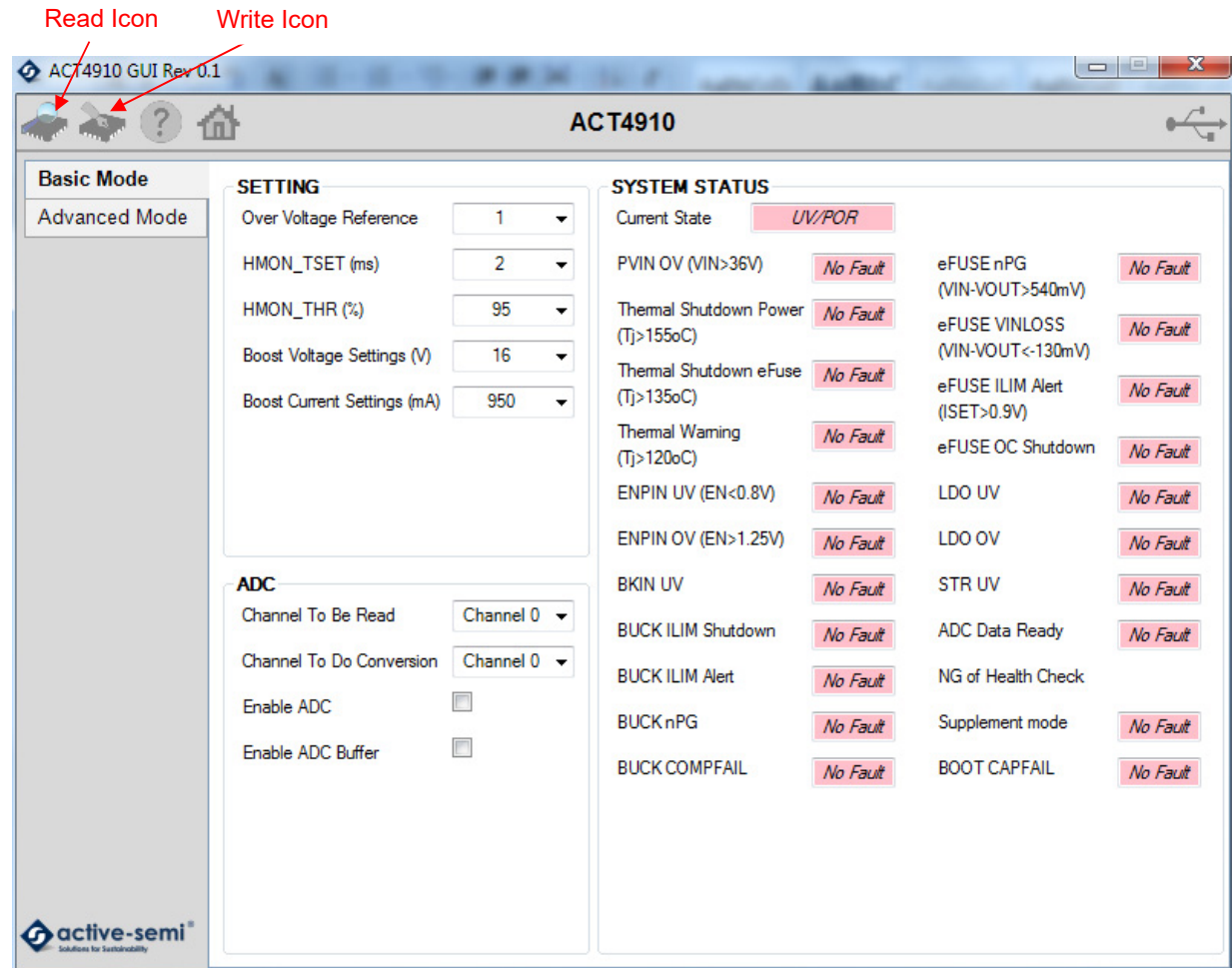

Figure 10 – GUI Basic Mode

Advanced Mode

Click the “Advanced Mode” button in the left of the GUI screen to see all available user programmable options. With Advanced Mode, additional user programmable features can be selected using the button text. In the left side of the Advanced Mode Screen, click on the Tiles Selector to display the register to view or change. Then change a register one bit at a time by clicking on the desired bit. The value of the bit is display right next to the bit-name button.

Note that the far right side of the screen contains a scroll down button to scroll down to additional registers since the Tile Screen can only display up to 8 bytes at once.

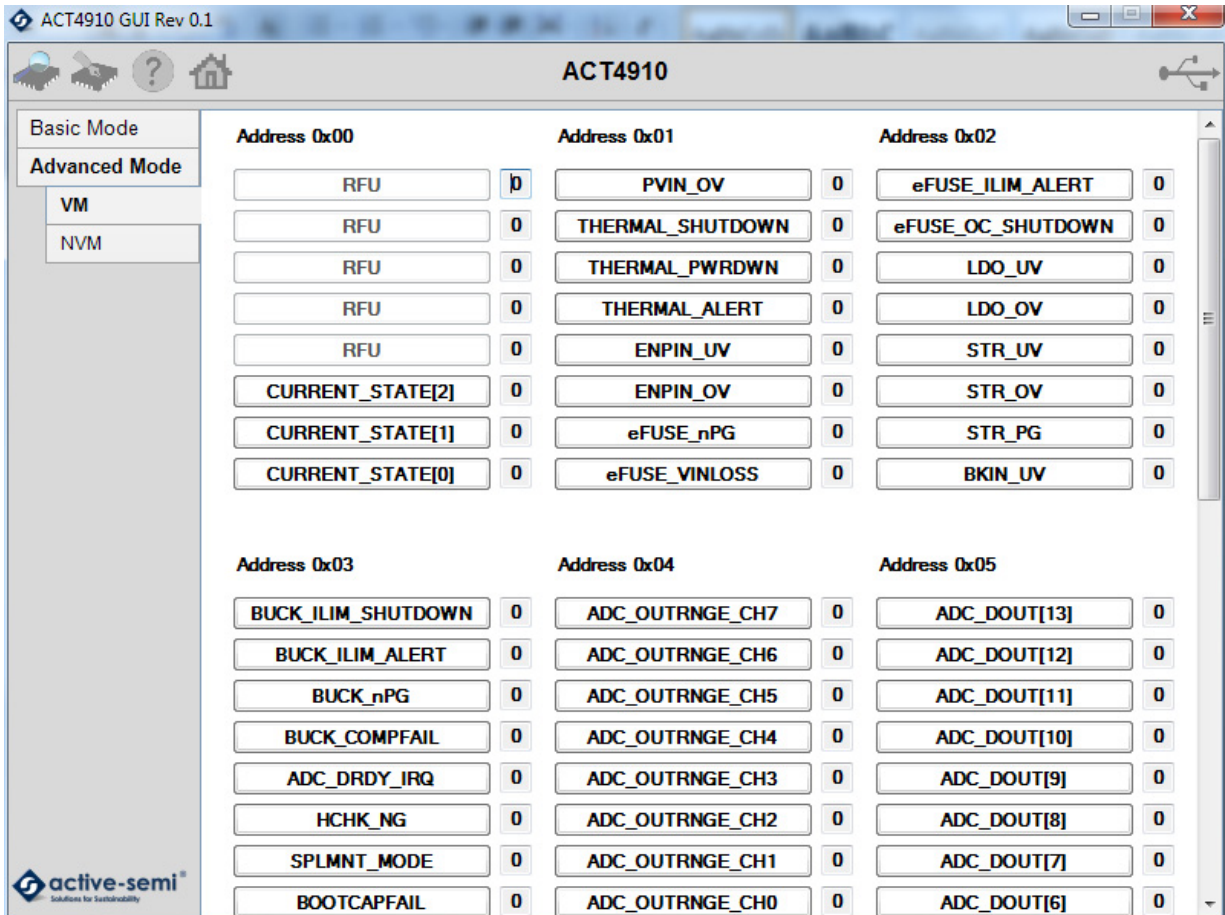

Figure 11 – GUI Advanced Mode

Button Descriptions

Read: Clicking on this button reads the ACT4911 registers and displays them in the GUI. Note that this reads all registers. Active-Semi recommends reading registers each time the ACT4911 powers-up to acquire the initial register settings. Active-semi also recommends reading registers after making changes to them. Immediately reading the registers after a write confirms the changes were properly stored. This also updates the SYSTEM STATUS box to ensure that one of the changes did not generate a fault condition.

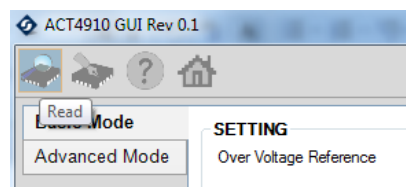

Figure 12 – Read Button

Write: Clicking on this button writes the GUI settings to the ACT4911's registers. All registers are written, regardless of whether or not they were changed.

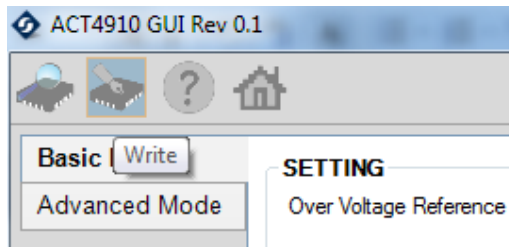

Figure 13 – Write Button

Компания «Океан Электроники» предлагает заключение долгосрочных отношений при поставках импортных электронных компонентов на взаимовыгодных условиях!

Наши преимущества:

- Поставка оригинальных импортных электронных компонентов напрямую с производств Америки, Европы и Азии, а так же с крупнейших складов мира;
- Широкая линейка поставок активных и пассивных импортных электронных компонентов (более 30 млн. наименований);
- Поставка сложных, дефицитных, либо снятых с производства позиций;
- Оперативные сроки поставки под заказ (от 5 рабочих дней);
- Экспресс доставка в любую точку России;
- Помощь Конструкторского Отдела и консультации квалифицированных инженеров;
- Техническая поддержка проекта, помощь в подборе аналогов, поставка прототипов;
- Поставка электронных компонентов под контролем ВП;
- Система менеджмента качества сертифицирована по Международному стандарту ISO 9001;
- При необходимости вся продукция военного и аэрокосмического назначения проходит испытания и сертификацию в лаборатории (по согласованию с заказчиком);
- Поставка специализированных компонентов военного и аэрокосмического уровня качества (Xilinx, Altera, Analog Devices, Intersil, Interpoint, Microsemi, Actel, Aeroflex, Peregrine, VPT, Syfer, Eurofarad, Texas Instruments, MS Kennedy, Miteq, Cobham, E2V, MA-COM, Hittite, Mini-Circuits, General Dynamics и др.);

Компания «Океан Электроники» является официальным дистрибьютором и эксклюзивным представителем в России одного из крупнейших производителей разъемов военного и аэрокосмического назначения «**JONHON**», а так же официальным дистрибьютором и эксклюзивным представителем в России производителя высокотехнологичных и надежных решений для передачи СВЧ сигналов «**FORSTAR**».



JONHON

«**JONHON**» (основан в 1970 г.)

Разъемы специального, военного и аэрокосмического назначения:

(Применяются в военной, авиационной, аэрокосмической, морской, железнодорожной, горно- и нефтедобывающей отраслях промышленности)

«**FORSTAR**» (основан в 1998 г.)

ВЧ соединители, коаксиальные кабели,
кабельные сборки и микроволновые компоненты:

(Применяются в телекоммуникациях гражданского и специального назначения, в средствах связи, РЛС, а так же военной, авиационной и аэрокосмической отраслях промышленности).



Телефон: 8 (812) 309-75-97 (многоканальный)

Факс: 8 (812) 320-03-32

Электронная почта: ocean@oceanchips.ru

Web: <http://oceanchips.ru/>

Адрес: 198099, г. Санкт-Петербург, ул. Калинина, д. 2, корп. 4, лит. А