



MICROCHIP

MCP9600
Thermocouple IC
Evaluation Board
User's Guide

Note the following details of the code protection feature on Microchip devices:

- Microchip products meet the specification contained in their particular Microchip Data Sheet.
- Microchip believes that its family of products is one of the most secure families of its kind on the market today, when used in the intended manner and under normal conditions.
- There are dishonest and possibly illegal methods used to breach the code protection feature. All of these methods, to our knowledge, require using the Microchip products in a manner outside the operating specifications contained in Microchip's Data Sheets. Most likely, the person doing so is engaged in theft of intellectual property.
- Microchip is willing to work with the customer who is concerned about the integrity of their code.
- Neither Microchip nor any other semiconductor manufacturer can guarantee the security of their code. Code protection does not mean that we are guaranteeing the product as "unbreakable."

Code protection is constantly evolving. We at Microchip are committed to continuously improving the code protection features of our products. Attempts to break Microchip's code protection feature may be a violation of the Digital Millennium Copyright Act. If such acts allow unauthorized access to your software or other copyrighted work, you may have a right to sue for relief under that Act.

Information contained in this publication regarding device applications and the like is provided only for your convenience and may be superseded by updates. It is your responsibility to ensure that your application meets with your specifications. MICROCHIP MAKES NO REPRESENTATIONS OR WARRANTIES OF ANY KIND WHETHER EXPRESS OR IMPLIED, WRITTEN OR ORAL, STATUTORY OR OTHERWISE, RELATED TO THE INFORMATION, INCLUDING BUT NOT LIMITED TO ITS CONDITION, QUALITY, PERFORMANCE, MERCHANTABILITY OR FITNESS FOR PURPOSE. Microchip disclaims all liability arising from this information and its use. Use of Microchip devices in life support and/or safety applications is entirely at the buyer's risk, and the buyer agrees to defend, indemnify and hold harmless Microchip from any and all damages, claims, suits, or expenses resulting from such use. No licenses are conveyed, implicitly or otherwise, under any Microchip intellectual property rights unless otherwise stated.

Trademarks

The Microchip name and logo, the Microchip logo, dsPIC, FlashFlex, flexPWR, JukeBlox, KEELOQ, KEELOQ logo, Kleer, LANCheck, MediaLB, MOST, MOST logo, MPLAB, OptoLyzer, PIC, PICSTART, PIC³² logo, RightTouch, SpyNIC, SST, SST Logo, SuperFlash and UNI/O are registered trademarks of Microchip Technology Incorporated in the U.S.A. and other countries.

The Embedded Control Solutions Company and mTouch are registered trademarks of Microchip Technology Incorporated in the U.S.A.

Analog-for-the-Digital Age, BodyCom, chipKIT, chipKIT logo, CodeGuard, dsPICDEM, dsPICDEM.net, ECAN, In-Circuit Serial Programming, ICSP, Inter-Chip Connectivity, KleerNet, KleerNet logo, MiWi, motorBench, MPASM, MPF, MPLAB Certified logo, MPLIB, MPLINK, MultiTRAK, NetDetach, Omniscient Code Generation, PICDEM, PICDEM.net, PICkit, PICTail, RightTouch logo, REAL ICE, SQI, Serial Quad I/O, Total Endurance, TSHARC, USBCheck, VariSense, ViewSpan, WiperLock, Wireless DNA, and ZENA are trademarks of Microchip Technology Incorporated in the U.S.A. and other countries.

SQTP is a service mark of Microchip Technology Incorporated in the U.S.A.

Silicon Storage Technology is a registered trademark of Microchip Technology Inc. in other countries.

GestIC is a registered trademark of Microchip Technology Germany II GmbH & Co. KG, a subsidiary of Microchip Technology Inc., in other countries.

All other trademarks mentioned herein are property of their respective companies.

© 2015, Microchip Technology Incorporated, Printed in the U.S.A., All Rights Reserved.

ISBN: 978-1-63277-748-5

**QUALITY MANAGEMENT SYSTEM
CERTIFIED BY DNV
= ISO/TS 16949 =**

Microchip received ISO/TS-16949:2009 certification for its worldwide headquarters, design and wafer fabrication facilities in Chandler and Tempe, Arizona; Gresham, Oregon and design centers in California and India. The Company's quality system processes and procedures are for its PIC® MCUs and dsPIC® DSCs, KEELOQ® code hopping devices, Serial EEPROMs, microperipherals, nonvolatile memory and analog products. In addition, Microchip's quality system for the design and manufacture of development systems is ISO 9001:2000 certified.

Object of Declaration: MCP9600 Thermocouple IC Evaluation Board

EU Declaration of Conformity

Manufacturer: Microchip Technology Inc.
2355 W. Chandler Blvd.
Chandler, Arizona, 85224-6199
USA

This declaration of conformity is issued by the manufacturer.

The development/evaluation tool is designed to be used for research and development in a laboratory environment. This development/evaluation tool is not a Finished Appliance, nor is it intended for incorporation into Finished Appliances that are made commercially available as single functional units to end users under EU EMC Directive 2004/108/EC and as supported by the European Commission's Guide for the EMC Directive 2004/108/EC (8th February 2010).

This development/evaluation tool complies with EU RoHS2 Directive 2011/65/EU.

This development/evaluation tool, when incorporating wireless and radio-telecom functionality, is in compliance with the essential requirement and other relevant provisions of the R&TTE Directive 1999/5/EC and the FCC rules as stated in the declaration of conformity provided in the module datasheet and the module product page available at www.microchip.com.

For information regarding the exclusive, limited warranties applicable to Microchip products, please see Microchip's standard terms and conditions of sale, which are printed on our sales documentation and available at www.microchip.com.

Signed for and on behalf of Microchip Technology Inc. at Chandler, Arizona, USA

Derek Carlson
VP Development Tools

12-Sep-14
Date

NOTES:



MCP9600 THERMOCOUPLE IC EVALUATION BOARD USER'S GUIDE

Table of Contents

Preface	7
Introduction.....	7
Document Layout	7
Conventions Used in This Guide.....	8
Recommended Reading.....	9
The Microchip Web Site	9
Customer Support	9
Revision History	9
Chapter 1. Product Overview	
1.1 Introduction	11
1.2 What is the MCP9600 Device?	11
1.3 What is the MCP9600 Thermocouple IC Evaluation Board?	11
1.4 What the MCP9600 Thermocouple IC Evaluation Board Kit Contains	11
Chapter 2. Installation and Operation	
2.1 Introduction	13
2.2 Required Tool	13
2.3 Getting Started	14
2.3.1 Hardware Setup	14
2.3.2 Hardware Operation	14
2.4 Microchip Thermal Management Software GUI	15
2.5 Configuring the MCP9600	17
2.6 Data Acquisition	18
Appendix A. Schematic and Layouts	
A.1 Introduction	19
A.2 Board Schematic	20
A.3 Board – Top Silk	21
A.4 Board – Top Copper and Silk	21
A.5 Board – Top Copper	22
A.6 Board – Bottom Copper	22
A.7 Board – Bottom Copper and Silk	23
A.8 Board – Bottom Silk	23
Appendix B. Bill of Materials (BOM)	25
Worldwide Sales and Service	28

MCP9600 Thermocouple IC Evaluation Board User's Guide

NOTES:



MCP9600 THERMOCOUPLE IC EVALUATION BOARD USER'S GUIDE

Preface

NOTICE TO CUSTOMERS

All documentation becomes dated, and this manual is no exception. Microchip tools and documentation are constantly evolving to meet customer needs, so some actual dialogs and/or tool descriptions may differ from those in this document. Please refer to our web site (www.microchip.com) to obtain the latest documentation available.

Documents are identified with a “DS” number. This number is located on the bottom of each page, in front of the page number. The numbering convention for the DS number is “DSXXXXXXXXA”, where “XXXXXXXX” is the document number and “A” is the revision level of the document.

For the most up-to-date information on development tools, see the MPLAB® IDE online help. Select the Help menu, and then Topics to open a list of available online help files.

INTRODUCTION

This chapter contains general information that will be useful to know before using the MCP9600 Thermocouple IC Evaluation Board. Items discussed in this chapter include:

- Document Layout
- Conventions Used in This Guide
- Recommended Reading
- The Microchip Web Site
- Customer Support
- Revision History

DOCUMENT LAYOUT

This document describes how to use the MCP9600 Thermocouple IC Evaluation Board as a development tool. The document is organized as follows:

- **Chapter 1. “Product Overview”** – This chapter includes important information about the MCP9600 Thermocouple IC Evaluation Board.
- **Chapter 2. “Installation and Operation”** – This chapter includes a detailed description of each function of the evaluation board and instructions on how to begin using the board.
- **Appendix A. “Schematic and Layouts”** – Shows the schematic and layout diagrams for MCP9600 Thermocouple IC Evaluation Board.
- **Appendix B. “Bill of Materials (BOM)”** – Lists the parts used to build the MCP9600 Thermocouple IC Evaluation Board.

MCP9600 Thermocouple IC Evaluation Board User's Guide

CONVENTIONS USED IN THIS GUIDE

This manual uses the following documentation conventions:

DOCUMENTATION CONVENTIONS

Description	Represents	Examples
Arial font:		
Italic characters	Referenced books	<i>MPLAB[®] IDE User's Guide</i>
	Emphasized text	...is the <i>only</i> compiler...
Initial caps	A window	the Output window
	A dialog	the Settings dialog
	A menu selection	select Enable Programmer
Quotes	A field name in a window or dialog	"Save project before build"
Underlined, Italic text with right angle bracket	A menu path	<u><i>File>Save</i></u>
Bold characters	A dialog button	Click OK
	A tab	Click the Power tab
N'Rnnnn	A number in verilog format, where N is the total number of digits, R is the radix and n is a digit.	4'b0010, 2'hF1
Text in angle brackets < >	A key on the keyboard	Press <Enter>, <F1>
Courier New font:		
Plain Courier New	Sample source code	#define START
	Filenames	autoexec.bat
	File paths	c:\mcc18\h
	Keywords	_asm, _endasm, static
	Command-line options	-Opa+, -Opa-
	Bit values	0, 1
	Constants	0xFF, 'A'
Italic Courier New	A variable argument	<i>file.o</i> , where <i>file</i> can be any valid filename
Square brackets []	Optional arguments	mcc18 [options] <i>file</i> [options]
Curly brackets and pipe character: { }	Choice of mutually exclusive arguments; an OR selection	errorlevel {0 1}
Ellipses...	Replaces repeated text	var_name [, var_name...]
	Represents code supplied by user	void main (void) { ... }

RECOMMENDED READING

This user's guide describes how to use MCP9600 Thermocouple IC Evaluation Board. Other useful documents are listed below. The following Microchip documents are available and recommended as supplemental reference resources:

- **MCP9600 Data Sheet – “Thermocouple Voltage to Temperature Converter, $\pm 1.5^{\circ}\text{C}$ Maximum Accuracy” (DS20005426)**

This data sheet provides detailed information regarding the MCP9600 device.

- **PIC18F2455/2550/4455/4550 Data Sheet – “28/40/44-Pin, High-Performance, Enhanced Flash, USB Microcontrollers with nanoWatt Technology” (DS39632)**

This data sheet provides detailed information regarding the PIC18F2455/2550/4455/4550 devices.

THE MICROCHIP WEB SITE

Microchip provides online support via our web site at www.microchip.com. This web site is used as a means to make files and information easily available to customers. Accessible by using your favorite Internet browser, the web site contains the following information:

- **Product Support** – Data sheets and errata, application notes and sample programs, design resources, user's guides and hardware support documents, latest software releases and archived software
- **General Technical Support** – Frequently Asked Questions (FAQs), technical support requests, online discussion groups, Microchip consultant program member listing
- **Business of Microchip** – Product selector and ordering guides, latest Microchip press releases, listing of seminars and events, listings of Microchip sales offices, distributors and factory representatives

CUSTOMER SUPPORT

Users of Microchip products can receive assistance through several channels:

- Distributor or Representative
- Local Sales Office
- Field Application Engineer (FAE)
- Technical Support

Customers should contact their distributor, representative or field application engineer (FAE) for support. Local sales offices are also available to help customers. A listing of sales offices and locations is included in the back of this document.

Technical support is available through the web site at:
<http://www.microchip.com/support>.

REVISION HISTORY

Revision A (September 2015)

- Original release of this document.

MCP9600 Thermocouple IC Evaluation Board User's Guide

NOTES:

Chapter 1. Product Overview

1.1 INTRODUCTION

This chapter provides an overview of the MCP9600 Thermocouple IC Evaluation Board and covers the following topics:

- What is the MCP9600 Device?
- What is the MCP9600 Thermocouple IC Evaluation Board?
- What the MCP9600 Thermocouple IC Evaluation Board Kit Contains

1.2 WHAT IS THE MCP9600 DEVICE?

The MCP9600 is a Thermocouple Electromotive Force (EMF) to temperature converter. This device converts thermocouple EMF to degree Celsius with integrated Cold-Junction compensation. MCP9600 corrects the thermocouple nonlinear error characteristics of eight thermocouple types and outputs $\pm 1.5^{\circ}\text{C}$ accurate temperature data for the selected thermocouple. The correction coefficients are derived from the National Institute of Standards and Technology (NIST) ITS-90 Thermocouple Database.

1.3 WHAT IS THE MCP9600 THERMOCOUPLE IC EVALUATION BOARD?

The MCP9600 Thermocouple IC Evaluation Board is used to evaluate MCP9600 Thermocouple EMF voltage to degree Celsius converter. Users can easily evaluate all device features using a Type K thermocouple. The device also supports Types J, T, N, E, B, S and R thermocouples. Each of these types can be evaluated by replacing the Type K thermocouple connector with the corresponding connectors.

In addition, the MCP9600 Thermocouple IC Evaluation Board connects to a PC via a USB interface. Temperature can be data-logged using the Microchip Thermal Management Software Graphical User Interface (GUI).

1.4 WHAT THE MCP9600 THERMOCOUPLE IC EVALUATION BOARD KIT CONTAINS

The MCP9600 Thermocouple IC Evaluation Board package includes:

- MCP9600 Thermocouple IC Evaluation Board (ADM00665)
- Type K Thermocouple
- Mini USB Cable
- Important Information Sheet

NOTES:

Chapter 2. Installation and Operation

2.1 INTRODUCTION

The MCP9600 Thermocouple IC Evaluation Board enables users to easily evaluate all user-programmable features such as thermocouple selection, temperature alert limit settings, temperature resolutions and Power mode.

Items discussed in this chapter include:

- Required Tool
- Getting Started
- Microchip Thermal Management Software GUI
- Configuring the MCP9600
- Data Acquisition

2.2 REQUIRED TOOL

The Personal Computer (PC) shown in [Figure 2-1](#) needs to run on Windows® 98 SE or later. It provides a convenient interface for the user, communicates with the board and provides power through the USB connection.

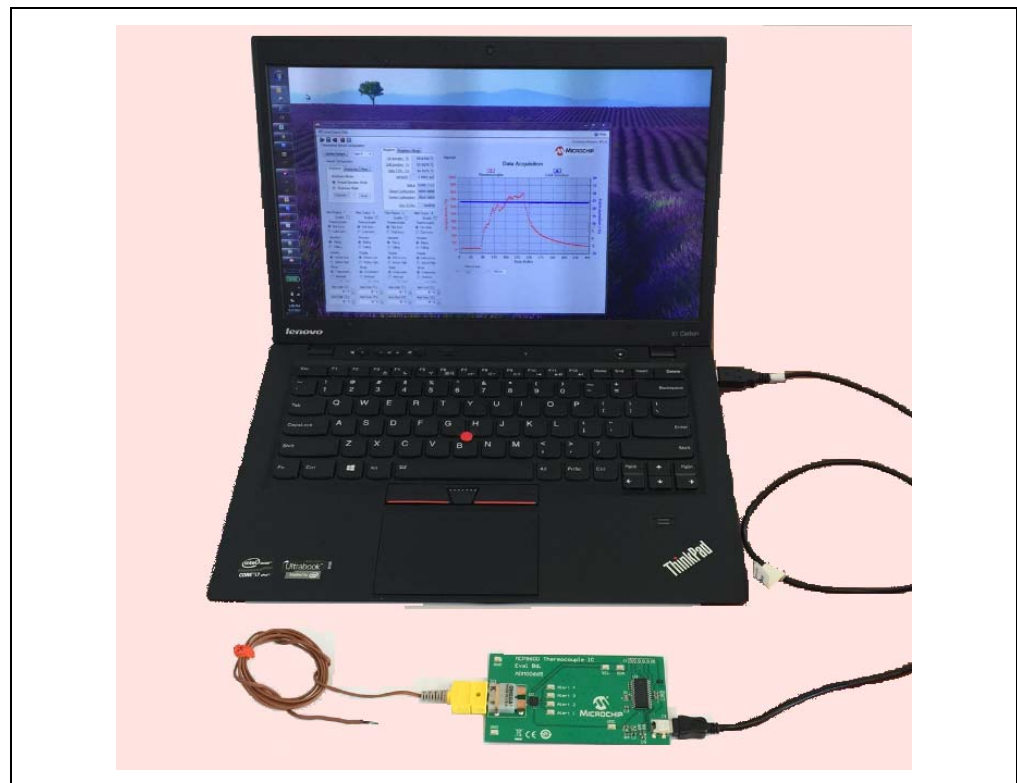

FIGURE 2-1: MCP9600 Thermocouple IC Evaluation Board Setup.

2.3 GETTING STARTED

This section describes how to power up and interface with the MCP9600 Thermocouple IC Evaluation Board.

2.3.1 Hardware Setup

1. The MCP9600 Thermocouple IC Evaluation Board has a mini USB connector for a PC interface. Connect the USB cable from the evaluation board to a PC.

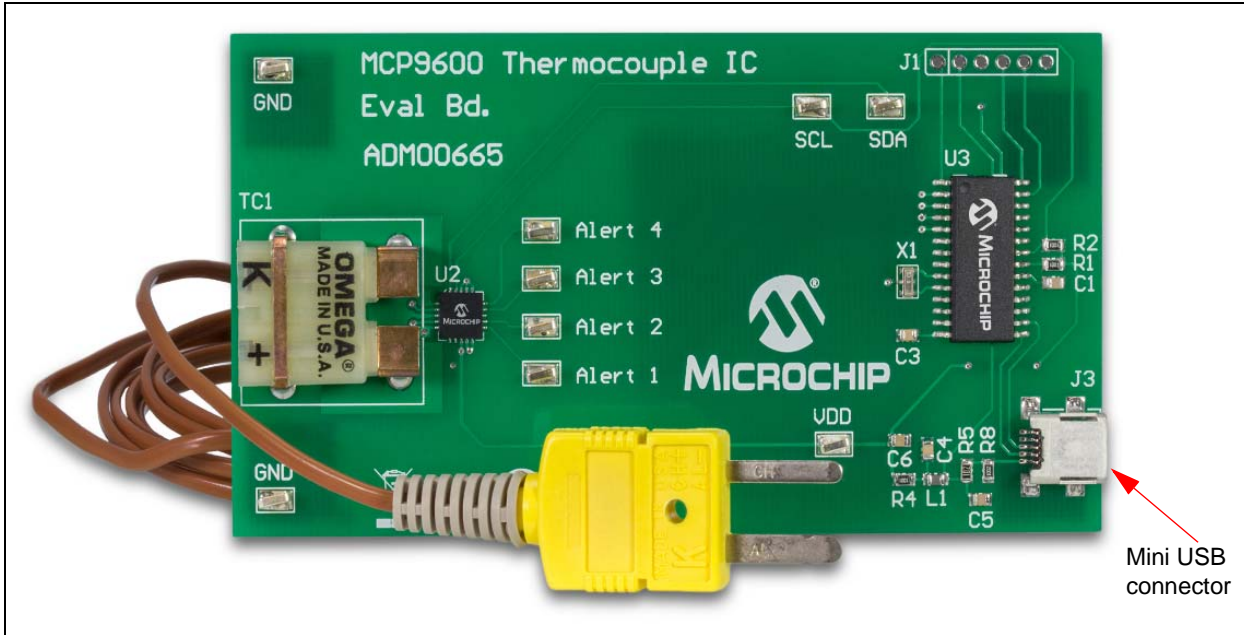

FIGURE 2-2: MCP9600 Thermocouple IC Evaluation Board.

2.3.2 Hardware Operation

The MCP9600 Thermocouple IC Evaluation Board is fully powered from a PC USB 5V source. Once power is applied via USB and the USB is successfully enumerated, the PIC[®] microcontroller is ready to receive commands from the host PC to program the MCP9600 settings or transfer temperature data.

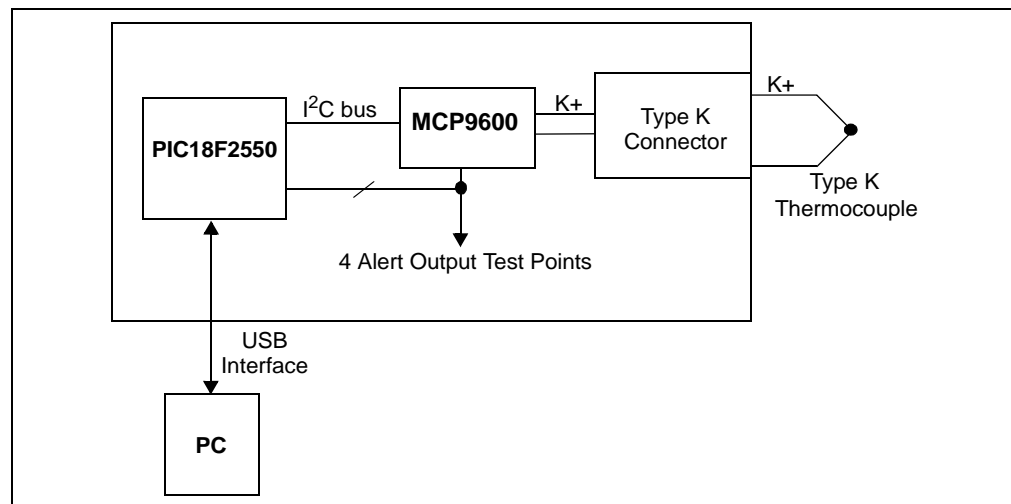

FIGURE 2-3: Functional Block Diagram.

The block diagram (Figure 2-3) shows that the thermocouple connector is directly connected to the MCP9600. The four Alert outputs are connected to test points for external connections. Additionally, these outputs are also connected to the microcontroller I/O pins so that the Alert Output statuses can be detected in software.

2.4 MICROCHIP THERMAL MANAGEMENT SOFTWARE GUI

The Microchip Thermal Management Graphical User Interface allows users to evaluate the MCP9600 for temperature-sensing applications. This software tool can be downloaded and installed from the evaluation board product page. The software requires the 'Microsoft.NET Framework' package. If this framework package is not installed on the computer, then the software will automatically download and install it. After the installation is successfully completed, the hardware is required to start the graphical user interface.

Once the hardware is connected, the software recognizes the device ID and displays the corresponding GUI for the evaluation board. Disconnecting the USB will close the GUI. This tool enables the user to evaluate the sensor features and perform temperature data logging.

Figure 2-4 shows the data acquisition interface with a plot of the thermocouple Hot-Junction and Cold-Junction temperature data. The Y1 axis is the Hot-Junction temperature and the Y2 axis is the Cold-Junction temperature. This data can also be exported by right-clicking the plot and following the export options.

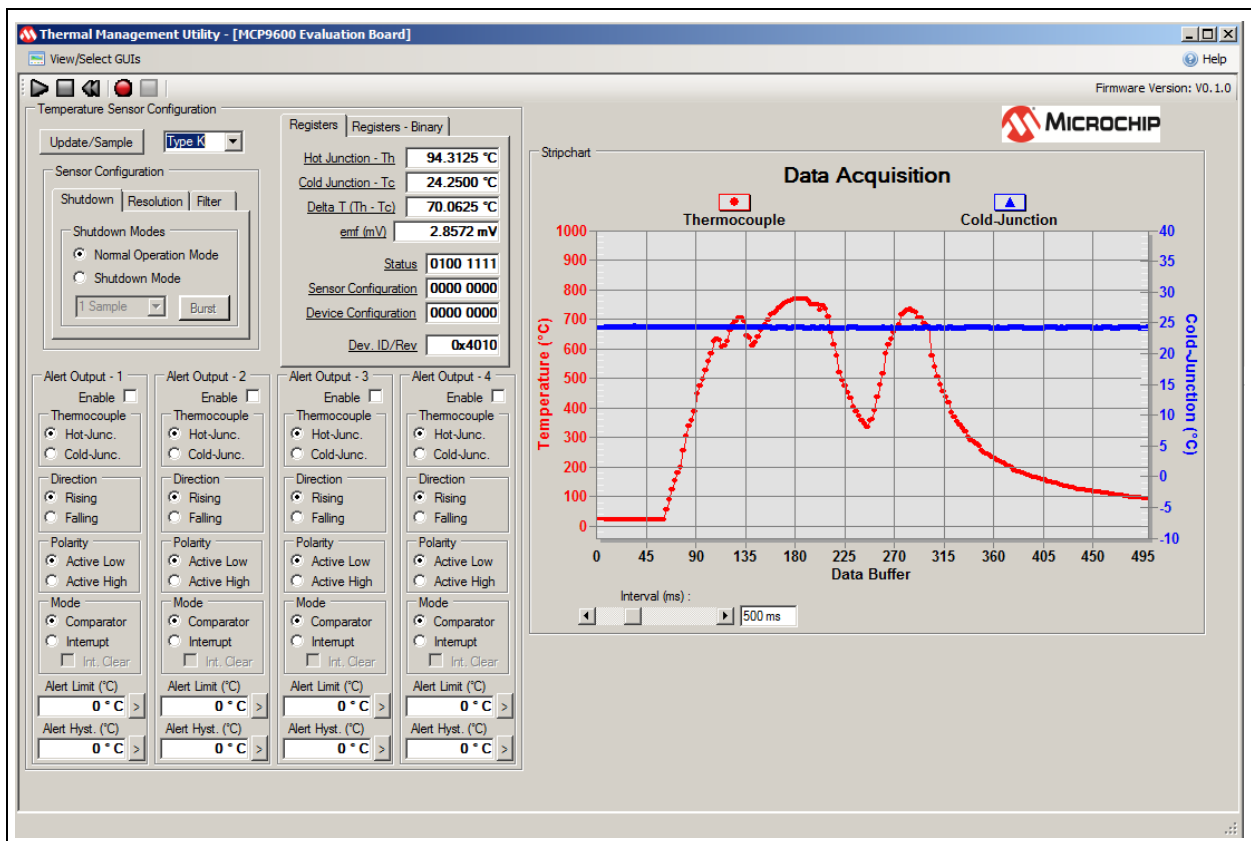

FIGURE 2-4: Data Acquisition Interface.

Use the Thermal Management Software Graphical User Interface (GUI) for temperature data logging or to evaluate the sensor board features. If the hardware is properly connected, the software will recognize the hardware, otherwise, the software will show the 'Hardware Not Detected' message box, as indicated in [Figure 2-5](#).

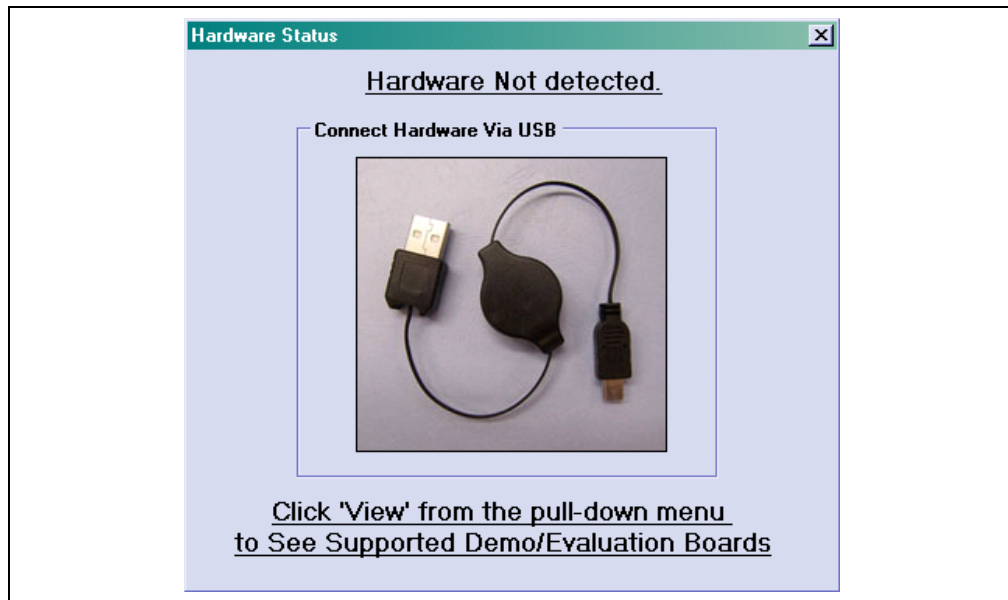

FIGURE 2-5: *Hardware Not Detected Message Box.*

2.5 CONFIGURING THE MCP9600

Figure 2-6 shows the user interface for various sensor options. Once these options are selected, the software programs the device and refreshes the GUI from the device. Therefore the GUI displays the updated device settings.

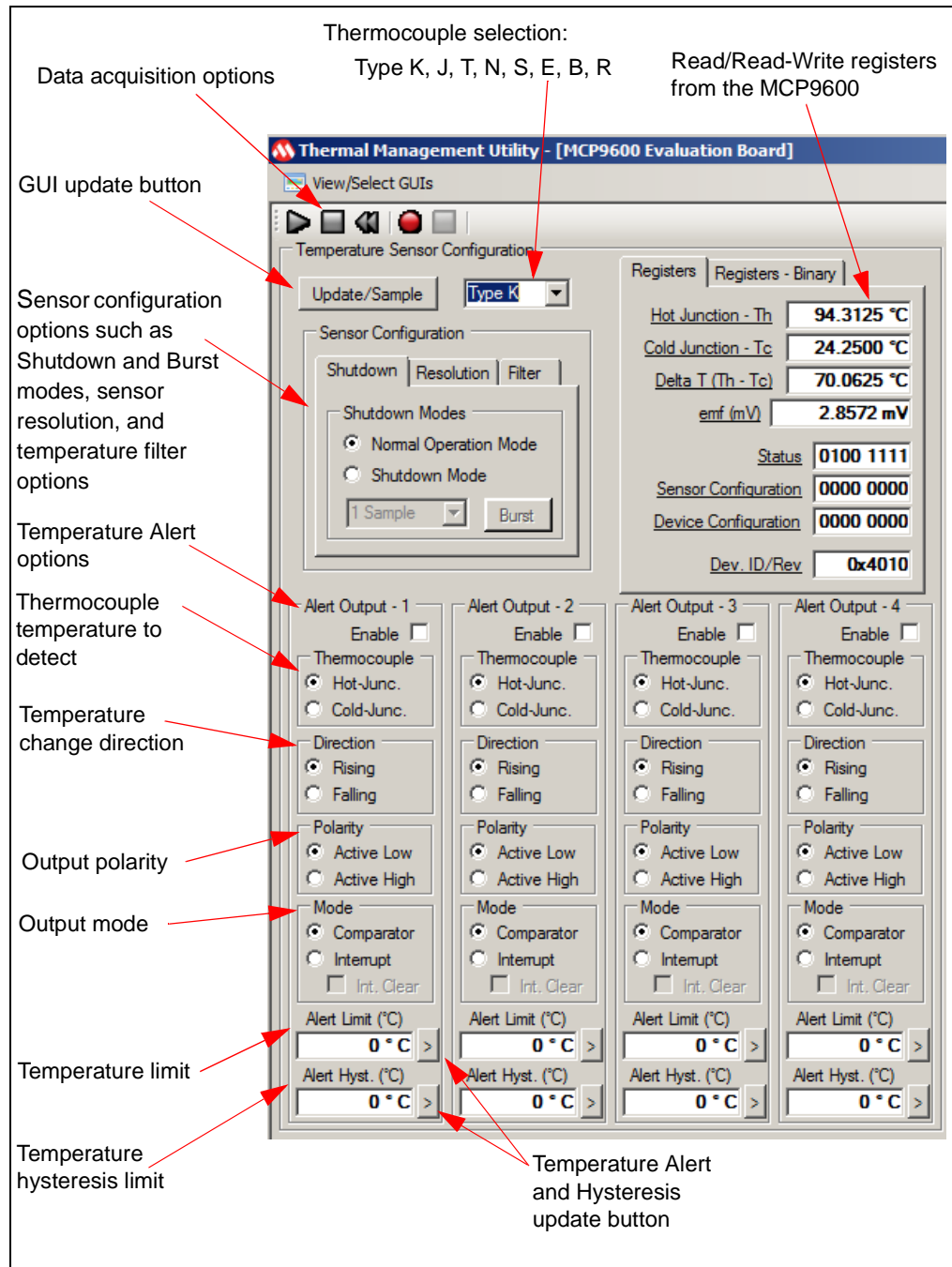

FIGURE 2-6: Sensor Configuration Options.

2.6 DATA ACQUISITION

The black “Play”, “Stop”, and “Reset” icons (Figure 2-7) can be used to perform continuous data acquisitions. The red “Record” icon enables the user to data log to an external file. The logging interval can be adjusted using the Interval scroll bar from 100 ms to 30s, as shown in Figure 2-4.

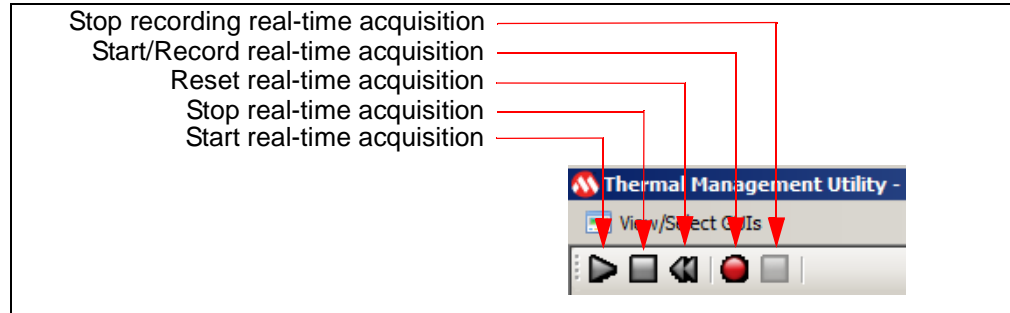

FIGURE 2-7: Real-Time Acquisition.

The data acquisition display chart (Figure 2-4) can be customized. The customizing options (Figure 2-8) can be selected by either double-clicking or right-clicking the chart (Figure 2-4). The displayed data can also be exported.

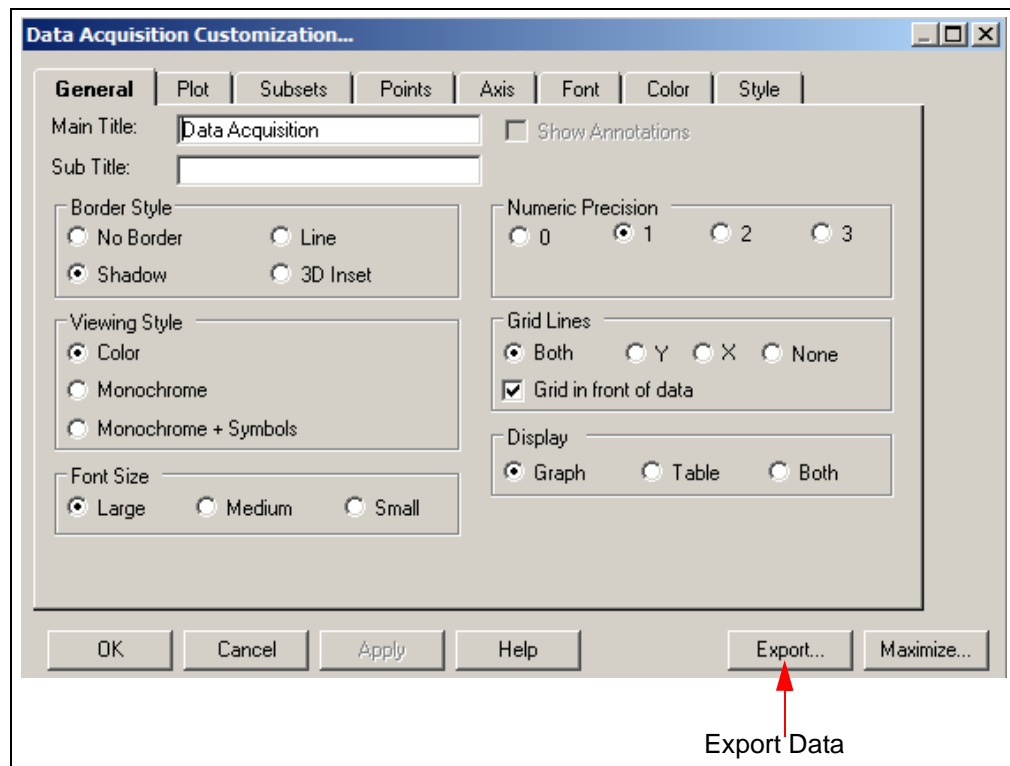

FIGURE 2-8: Chart Setup Options.



MCP9600 THERMOCOUPLE IC EVALUATION BOARD USER'S GUIDE

Appendix A. Schematic and Layouts

A.1 INTRODUCTION

This appendix contains the following schematics and layouts for the MCP9600 Thermocouple IC Evaluation Board:

- Board Schematic
- Board – Top Silk
- Board – Top Copper and Silk
- Board – Top Copper
- Board – Bottom Copper
- Board – Bottom Copper and Silk
- Board – Bottom Silk

A.3 BOARD – TOP SILK

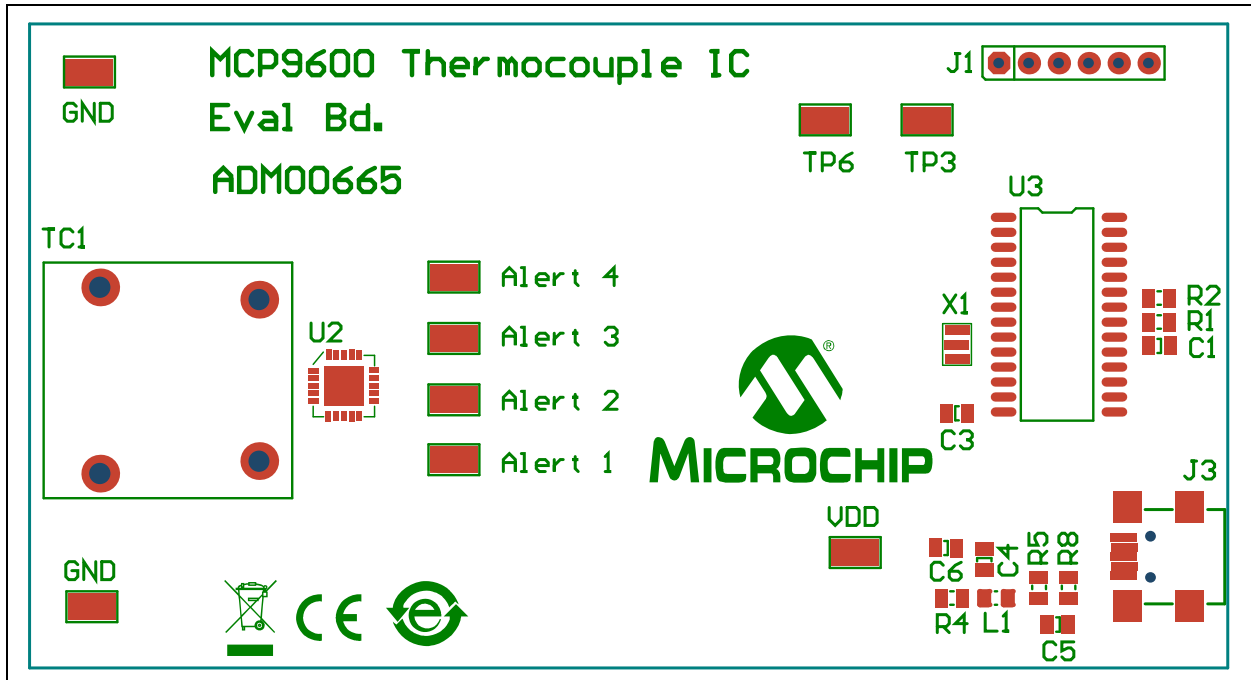

A.4 BOARD – TOP COPPER AND SILK

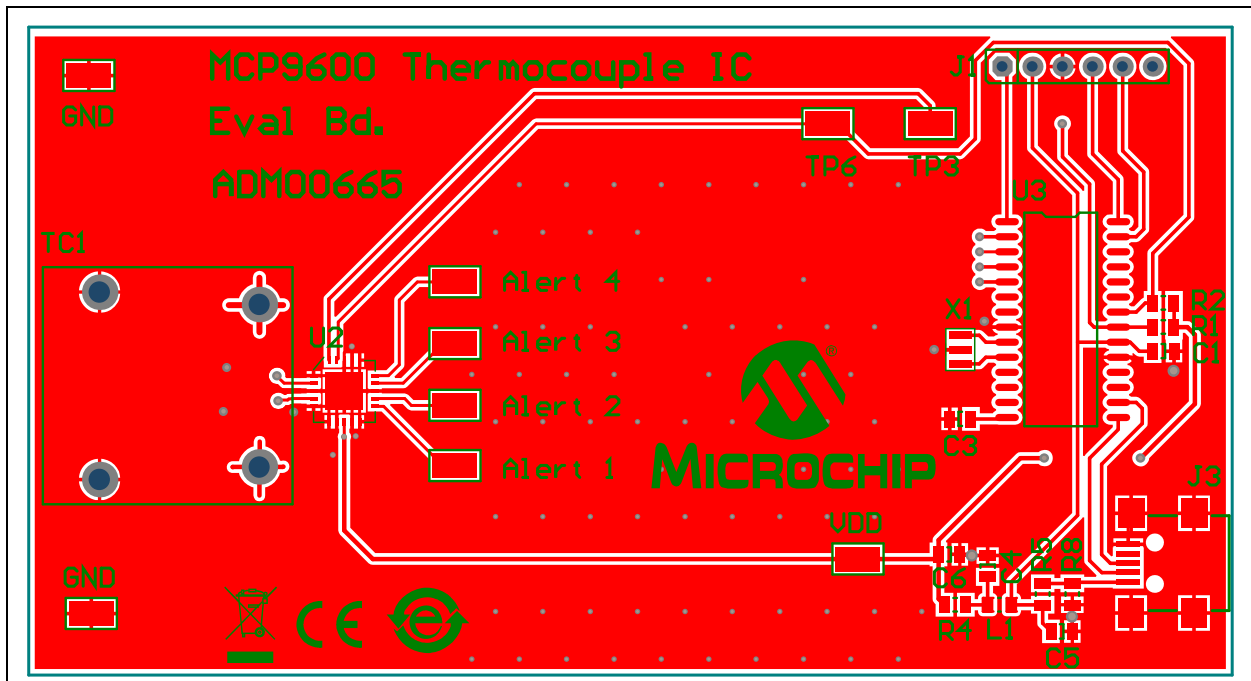

A.5 BOARD – TOP COPPER

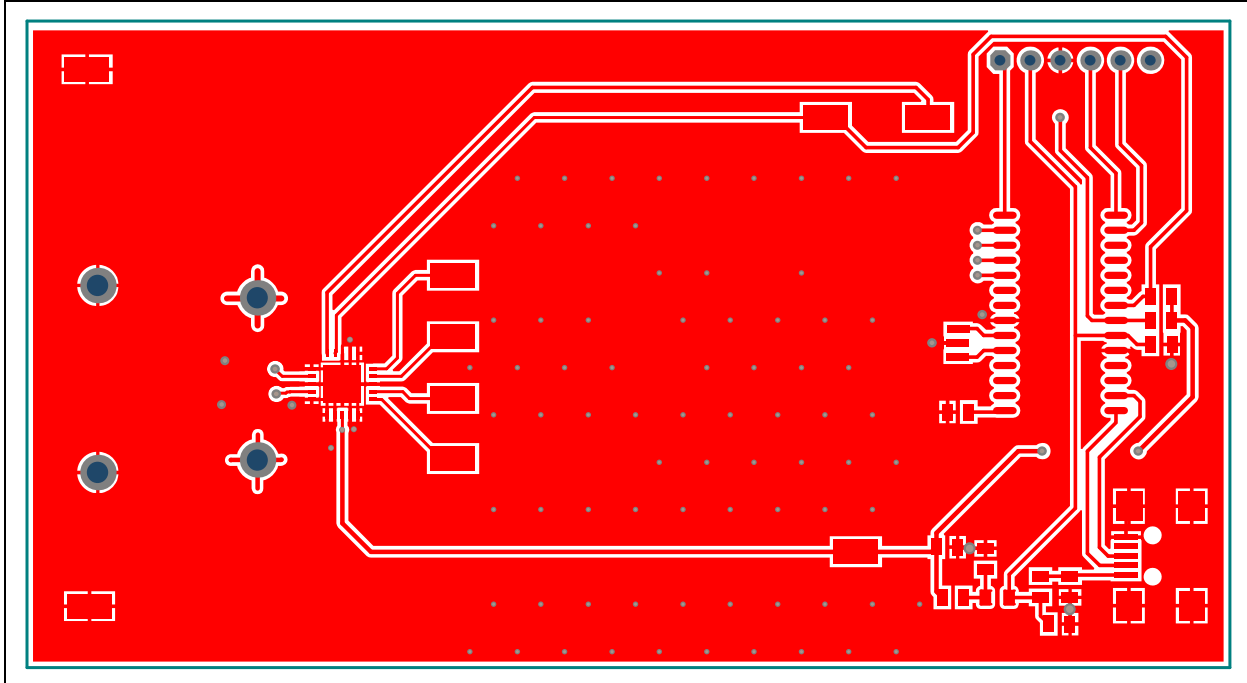

A.6 BOARD – BOTTOM COPPER

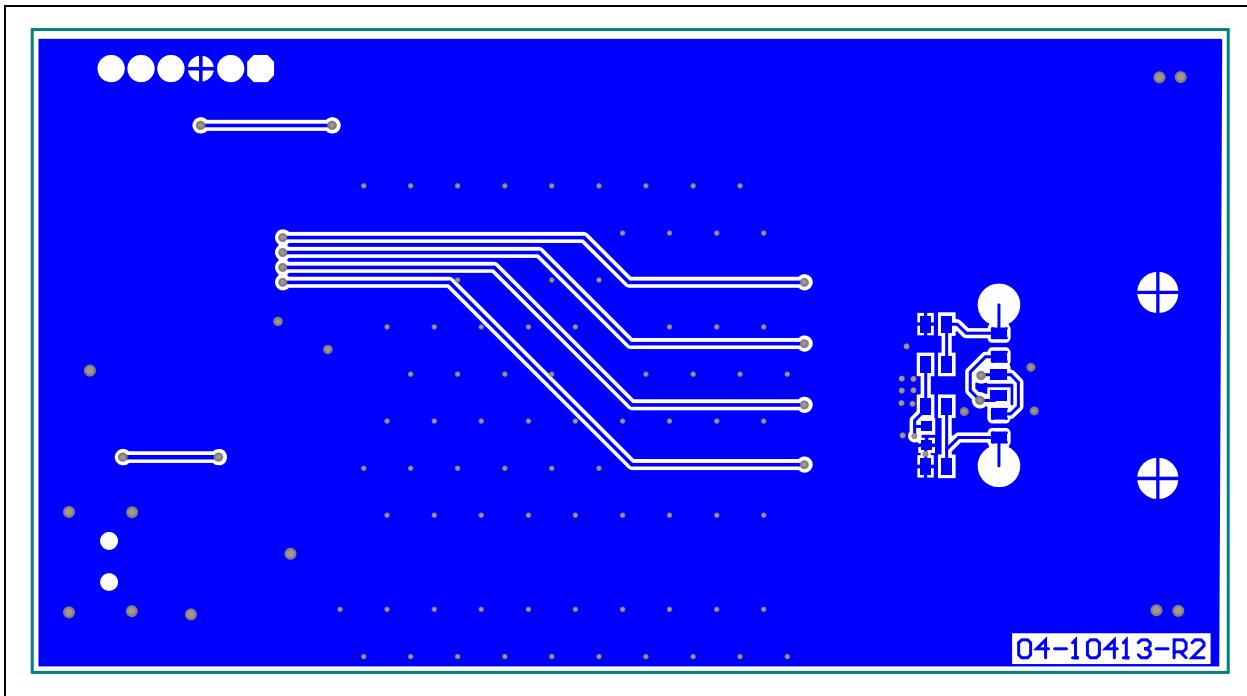

A.7 BOARD – BOTTOM COPPER AND SILK

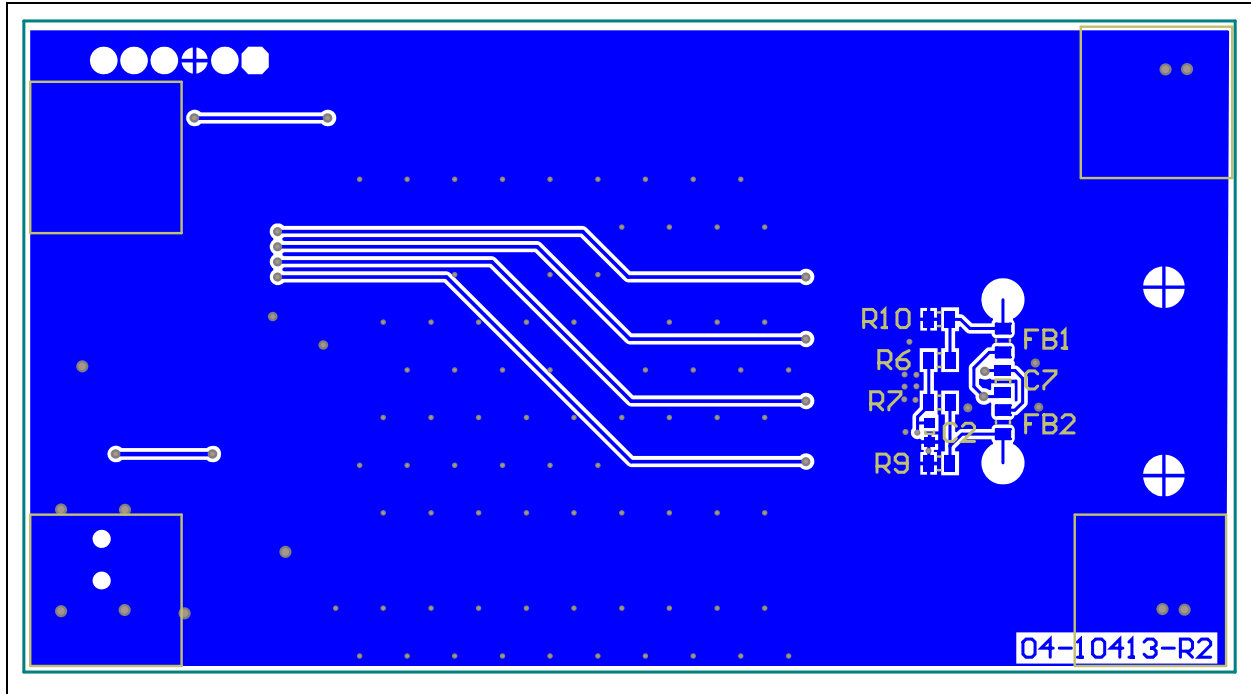

A.8 BOARD – BOTTOM SILK

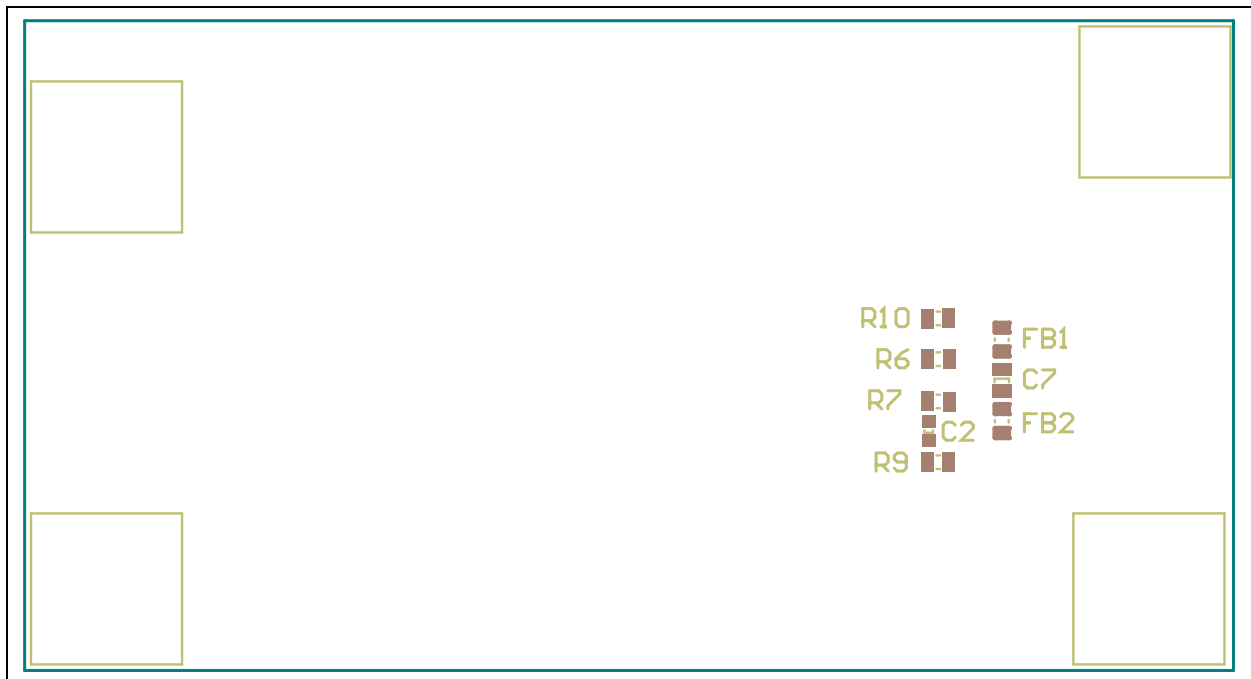

MCP9600 Thermocouple IC Evaluation Board User's Guide

NOTES:

Appendix B. Bill of Materials (BOM)

TABLE B-1: BILL OF MATERIALS (BOM)

Qty	Reference	Description	Manufacturer	Part Number
9	Alert 1, Alert 2, Alert 3, Alert 4, GND, GND, SCL, SDA, V _{DD}	Connector TP tab silver mini 3.8x2.03 SMD	Keystone Electronics Corp.	5019
2	C1, C7	Ceramic capacitor, 1 μ F, 50V, 10%, X7R SMD, 0805	Cal-Chip Electronics Inc.	GMC21X7R104K50NTLF
1	C2	Ceramic Capacitor, 0.1 μ F, 25V, 20%, Y5V SMD, 0603	Cal-Chip Electronics Inc.	GMC10Y5V104Z25NTLF
1	C3	Ceramic capacitor, 0.47 μ F, 16V, 10%, X7R SMD, 0805	Panasonic [®] - ECG	ECJ-2YB1C474K
2	C4, C5	Ceramic capacitor, 10 μ F, 6.3V, 20%, X5R SMD, 0805	Taiyo Yuden Co., Ltd.	JMK212BJ106MG-T
1	C6	Ceramic capacitor, 1 μ F, 16V, 20%, Y5V SMD, 0805	AVX Corporation	0805YG105ZAT2A
2	FB1, FB2	Ferrite chip beads, 800 mA, 0.15R SMD, 0805	Laird Technologies [®]	LI0805H151R-10
0	J1	Connector header, 2.54 male 1x6, tin, 5.84 mm, Through Hole, vertical – DO NOT POPULATE	Sullins Connector Solutions	PEC06SAAN
1	J3	Connector, Mini USB, B-Type, female, SMD R/A	Hirose Electric Co., Ltd.	UX60-MB-5ST
1	L1	Inductor, 10 μ H, 100 mA, 20%, SMD, 0805	Murata Electronics [®]	LQM21FN100M70L
4	PAD1, PAD2, PAD3, PAD4	Mechanical HW rubber pad, square, L12.1xW12.1xH3.1, black	Hammond Manufacturing Ltd.	1421T8BK
0	PCB	MCP9600 Thermocouple IC Evaluation Board – Printed Circuit Board	—	04-10413-R2
2	R1, R2	Resistor, TKF 4.99K ohm, 1%, 1/8W, SMD, 0805	ROHM Semiconductor	MCR10EZHF4991
2	R4, R5	Resistor, TKF 10R, 1%, 1/8W, SMD 0805	ROHM Semiconductor	MCR10EZHF10R0
0	R6, R7	Resistor, TKF 100K, 1%, 1/8W, SMD 0805 – DO NOT POPULATE	NIC Components Corp.	NRC10F1003TRF
1	R8	Resistor TF, 100K, 0.1%, 1/8W, SMD 0805	Panasonic [®] - ECG	ERA-6AEB104V
0	R9, R10	Resistor TKF, 47.5K, 1%, 1/8W, SMD 0805 – DO NOT POPULATE	Panasonic [®] - ECG	ERJ-6ENF4752V

Note: The components listed in this Bill of Materials are representative of the PCB assembly. The released BOM used in manufacturing uses all RoHS-compliant components.

TABLE B-1: BILL OF MATERIALS (BOM) (CONTINUED)

Qty	Reference	Description	Manufacturer	Part Number
1	TC1	Mechanical HW adapter thermocouple TH R/A	Omega [®] Engineering Inc.	PCC-SMP-K-100 (100 pcs. per package)
1	U2	Sensor temp. ratiometric, 20MQFN	Microchip Technology Inc.	MCP9600-I/MX
1	U3	Microchip MCU 8-bit, 40 MHz, 32K, 1536B PIC18F2520-I/SO SOIC-28	Microchip Technology Inc.	PIC18F2550T-I/SO
1	X1	Resonator, 12 MHz, 33 pF, SMD, CSTCE-G	Murata Electronics [®]	CSTCE12M0G55Z-R0

Note: The components listed in this Bill of Materials are representative of the PCB assembly. The released BOM used in manufacturing uses all RoHS-compliant components.

BILL OF MATERIALS – MECHANICAL PARTS

Qty	Reference	Description	Manufacturer	Part Number
1	CBL1	Mech. HW cable USB, A-Type, male to Mini USB, B-Type, 3 ft, black	Qualtek Electronics Corporation	3021003-03
1	Plugs in TC1	Ready-made insulated thermocouples with Kapton [®] , PFA, Glass braid insulation and Molded connectors	Omega [®] Engineering Inc.	5SRTC-TT-K-24-36 (100 pcs. per package)

Note: The components listed in this Bill of Materials are representative of the PCB assembly. The released BOM used in manufacturing uses all RoHS-compliant components.

NOTES:



MICROCHIP

Worldwide Sales and Service

AMERICAS

Corporate Office

2355 West Chandler Blvd.
Chandler, AZ 85224-6199
Tel: 480-792-7200
Fax: 480-792-7277
Technical Support:
[http://www.microchip.com/
support](http://www.microchip.com/support)

Web Address:
www.microchip.com

Atlanta

Duluth, GA
Tel: 678-957-9614
Fax: 678-957-1455

Austin, TX

Tel: 512-257-3370

Boston

Westborough, MA
Tel: 774-760-0087
Fax: 774-760-0088

Chicago

Itasca, IL
Tel: 630-285-0071
Fax: 630-285-0075

Cleveland

Independence, OH
Tel: 216-447-0464
Fax: 216-447-0643

Dallas

Addison, TX
Tel: 972-818-7423
Fax: 972-818-2924

Detroit

Novi, MI
Tel: 248-848-4000

Houston, TX

Tel: 281-894-5983

Indianapolis

Noblesville, IN
Tel: 317-773-8323
Fax: 317-773-5453

Los Angeles

Mission Viejo, CA
Tel: 949-462-9523
Fax: 949-462-9608

New York, NY

Tel: 631-435-6000

San Jose, CA

Tel: 408-735-9110

Canada - Toronto

Tel: 905-673-0699
Fax: 905-673-6509

ASIA/PACIFIC

Asia Pacific Office

Suites 3707-14, 37th Floor
Tower 6, The Gateway
Harbour City, Kowloon

Hong Kong

Tel: 852-2943-5100
Fax: 852-2401-3431

Australia - Sydney

Tel: 61-2-9868-6733
Fax: 61-2-9868-6755

China - Beijing

Tel: 86-10-8569-7000
Fax: 86-10-8528-2104

China - Chengdu

Tel: 86-28-8665-5511
Fax: 86-28-8665-7889

China - Chongqing

Tel: 86-23-8980-9588
Fax: 86-23-8980-9500

China - Dongguan

Tel: 86-769-8702-9880

China - Hangzhou

Tel: 86-571-8792-8115
Fax: 86-571-8792-8116

China - Hong Kong SAR

Tel: 852-2943-5100
Fax: 852-2401-3431

China - Nanjing

Tel: 86-25-8473-2460
Fax: 86-25-8473-2470

China - Qingdao

Tel: 86-532-8502-7355
Fax: 86-532-8502-7205

China - Shanghai

Tel: 86-21-5407-5533
Fax: 86-21-5407-5066

China - Shenyang

Tel: 86-24-2334-2829
Fax: 86-24-2334-2393

China - Shenzhen

Tel: 86-755-8864-2200
Fax: 86-755-8203-1760

China - Wuhan

Tel: 86-27-5980-5300
Fax: 86-27-5980-5118

China - Xian

Tel: 86-29-8833-7252
Fax: 86-29-8833-7256

ASIA/PACIFIC

China - Xiamen

Tel: 86-592-2388138
Fax: 86-592-2388130

China - Zhuhai

Tel: 86-756-3210040
Fax: 86-756-3210049

India - Bangalore

Tel: 91-80-3090-4444
Fax: 91-80-3090-4123

India - New Delhi

Tel: 91-11-4160-8631
Fax: 91-11-4160-8632

India - Pune

Tel: 91-20-3019-1500

Japan - Osaka

Tel: 81-6-6152-7160
Fax: 81-6-6152-9310

Japan - Tokyo

Tel: 81-3-6880-3770
Fax: 81-3-6880-3771

Korea - Daegu

Tel: 82-53-744-4301
Fax: 82-53-744-4302

Korea - Seoul

Tel: 82-2-554-7200
Fax: 82-2-558-5932 or
82-2-558-5934

Malaysia - Kuala Lumpur

Tel: 60-3-6201-9857
Fax: 60-3-6201-9859

Malaysia - Penang

Tel: 60-4-227-8870
Fax: 60-4-227-4068

Philippines - Manila

Tel: 63-2-634-9065
Fax: 63-2-634-9069

Singapore

Tel: 65-6334-8870
Fax: 65-6334-8850

Taiwan - Hsin Chu

Tel: 886-3-5778-366
Fax: 886-3-5770-955

Taiwan - Kaohsiung

Tel: 886-7-213-7828

Taiwan - Taipei

Tel: 886-2-2508-8600
Fax: 886-2-2508-0102

Thailand - Bangkok

Tel: 66-2-694-1351
Fax: 66-2-694-1350

EUROPE

Austria - Wels

Tel: 43-7242-2244-39
Fax: 43-7242-2244-393

Denmark - Copenhagen

Tel: 45-4450-2828
Fax: 45-4485-2829

France - Paris

Tel: 33-1-69-53-63-20
Fax: 33-1-69-30-90-79

Germany - Dusseldorf

Tel: 49-2129-3766400

Germany - Karlsruhe

Tel: 49-721-625370

Germany - Munich

Tel: 49-89-627-144-0
Fax: 49-89-627-144-44

Italy - Milan

Tel: 39-0331-742611
Fax: 39-0331-466781

Italy - Venice

Tel: 39-049-7625286

Netherlands - Drunen

Tel: 31-416-690399
Fax: 31-416-690340

Poland - Warsaw

Tel: 48-22-3325737

Spain - Madrid

Tel: 34-91-708-08-90
Fax: 34-91-708-08-91

Sweden - Stockholm

Tel: 46-8-5090-4654

UK - Wokingham

Tel: 44-118-921-5800
Fax: 44-118-921-5820

07/14/15

Компания «Океан Электроники» предлагает заключение долгосрочных отношений при поставках импортных электронных компонентов на взаимовыгодных условиях!

Наши преимущества:

- Поставка оригинальных импортных электронных компонентов напрямую с производств Америки, Европы и Азии, а так же с крупнейших складов мира;
- Широкая линейка поставок активных и пассивных импортных электронных компонентов (более 30 млн. наименований);
- Поставка сложных, дефицитных, либо снятых с производства позиций;
- Оперативные сроки поставки под заказ (от 5 рабочих дней);
- Экспресс доставка в любую точку России;
- Помощь Конструкторского Отдела и консультации квалифицированных инженеров;
- Техническая поддержка проекта, помощь в подборе аналогов, поставка прототипов;
- Поставка электронных компонентов под контролем ВП;
- Система менеджмента качества сертифицирована по Международному стандарту ISO 9001;
- При необходимости вся продукция военного и аэрокосмического назначения проходит испытания и сертификацию в лаборатории (по согласованию с заказчиком);
- Поставка специализированных компонентов военного и аэрокосмического уровня качества (Xilinx, Altera, Analog Devices, Intersil, Interpoint, Microsemi, Actel, Aeroflex, Peregrine, VPT, Syfer, Eurofarad, Texas Instruments, MS Kennedy, Miteq, Cobham, E2V, MA-COM, Hittite, Mini-Circuits, General Dynamics и др.);

Компания «Океан Электроники» является официальным дистрибьютором и эксклюзивным представителем в России одного из крупнейших производителей разъемов военного и аэрокосмического назначения «JONHON», а так же официальным дистрибьютором и эксклюзивным представителем в России производителя высокотехнологичных и надежных решений для передачи СВЧ сигналов «FORSTAR».



JONHON

«JONHON» (основан в 1970 г.)

Разъемы специального, военного и аэрокосмического назначения:

(Применяются в военной, авиационной, аэрокосмической, морской, железнодорожной, горно- и нефтедобывающей отраслях промышленности)

«FORSTAR» (основан в 1998 г.)

ВЧ соединители, коаксиальные кабели, кабельные сборки и микроволновые компоненты:

(Применяются в телекоммуникациях гражданского и специального назначения, в средствах связи, РЛС, а так же военной, авиационной и аэрокосмической отраслях промышленности).



Телефон: 8 (812) 309-75-97 (многоканальный)

Факс: 8 (812) 320-03-32

Электронная почта: ocean@oceanchips.ru

Web: <http://oceanchips.ru/>

Адрес: 198099, г. Санкт-Петербург, ул. Калинина, д. 2, корп. 4, лит. А