

Cree® PLCC8 4 in 1 SMD LED CLQ6A-TKW

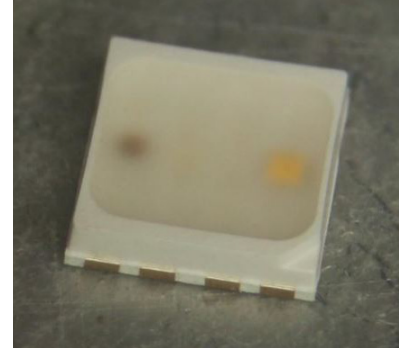

PRODUCT DESCRIPTION

These SMD LEDs are packaged in an industry standard PLCC8 package. These high performance 4 color SMT LEDs are designed to work in a wide range of applications. A wide viewing angle and high brightness make these LEDs suitable for signage applications.

FEATURES

- Size (mm): 5.0 x 5.2 x 1.1
- Dominant Wavelength/CCT
Red (619 - 624nm)
Green (520 - 535nm)
Blue (460 - 475nm)
White (3000K/4000K/5000K/5700K)
- Luminous Intensity (mcd)
Red (3000-5860)
Green (7030-14400)
Blue (1824-4180)
White (5860-12000)
- Moisture Sensitivity Level: 5a
- Lead-Free
- RoHS Compliant

APPLICATIONS

- Architecture Lighting
- Decorative Lighting
- Amusement

ABSOLUTE MAXIMUM RATINGS ($T_A = 25^\circ\text{C}$)

Items	Symbol	Absolute Maximum Rating				Unit
		R	G	B	W	
Forward Current ^{Note 1}	I_F	200	180	180	200	mA
Peak Forward Current ^{Note 2}	I_{FP}	500	400	400	500	mA
Reverse Voltage	V_R	5	5	5	5	V
Power Dissipation	P_D	520	684	684	720	mW
Operation Temperature	T_{opr}	-40 ~ +85				$^\circ\text{C}$
Storage Temperature	T_{stg}	-40 ~ +100				$^\circ\text{C}$
Junction Temperature	T_J	110	110	110	110	$^\circ\text{C}$
Junction/ambient	R_{THJA}	60	110	70	80	$^\circ\text{C/W}$
Junction/solder point	R_{THJS}	20	70	40	40	$^\circ\text{C/W}$
Electrostatic Discharge Classification(MIL-STD-883E)	ESD	1000 V				

Note: 1.Single-color light.
2.Pulse width ≤ 0.1 msec, duty $\leq 1/10$.

TYPICAL ELECTRICAL & OPTICAL CHARACTERISTICS ($T_A = 25^\circ\text{C}$)

Characteristics	Condition	Symbol	Values				Unit
			R	G	B	W	
Dominant Wavelength	$I_F = 100$ mA(R) $I_F = 100$ mA(G) $I_F = 100$ mA(B) $I_F = 100$ mA(W)	λ_{DOM}	619~624	520~535	460~475	NA	nm
Spectral bandwidth at 50% I_{REL} max	$I_F = 100$ mA(R) $I_F = 100$ mA(G) $I_F = 100$ mA(B) $I_F = 100$ mA(W)	$\Delta \lambda$	24	38	28	NA	nm
Forward Voltage	$I_F = 100$ mA(R) $I_F = 100$ mA(G) $I_F = 100$ mA(B) $I_F = 100$ mA(W)	$V_{F(avg)}$	2.1	3.0	3.1	2.9	V
		$V_{F(max)}$	2.6	3.8	3.8	3.6	V
Luminous Intensity	$I_F = 100$ mA(R) $I_F = 100$ mA(G) $I_F = 100$ mA(B) $I_F = 100$ mA(W)	$I_{V(min)}$	3000	7030	1824	5860	mcd
		$I_{V(avg)}$	4500	10400	3000	8200	mcd
Luminous Flux(Reference)	$I_F = 100$ mA(R) $I_F = 100$ mA(G) $I_F = 100$ mA(B) $I_F = 100$ mA(W)	$\Phi_{V(avg)}$	14	30	8.2	25	lm
Reverse Current (max)	$V_R = 5$ V	I_R	10	10	10	10	μA

Note: Continuous reverse voltage can cause LED damage.

INTENSITY BIN LIMIT (RED $I_F = 100\text{mA}$, GREEN $I_F = 100\text{mA}$, BLUE $I_F = 100\text{mA}$, WHITE $I_F = 100\text{mA}$)

Red

Bin Code	Min.(mcd)	Max.(mcd)
1L	3000	4180
1M	3590	5020
1N	4180	5860

Green

Bin Code	Min.(mcd)	Max.(mcd)
1R	7030	10100
1S	8200	12000
1T	10100	14400

Blue

Bin Code	Min.(mcd)	Max.(mcd)
1H	1824	2560
1J	2130	3000
1K	2560	3590
1L	3000	4180

White

Bin Code	Min.(mcd)	Max.(mcd)
1Q	5860	8200
1R	7030	10100
1S	8200	12000

Tolerance of measurement of luminous intensity is $\pm 10\%$.

COLOR BIN LIMIT (RED $I_F = 100\text{mA}$, GREEN $I_F = 100\text{mA}$, BLUE $I_F = 100\text{mA}$, WHITE $I_F = 100\text{mA}$)

Red

Bin Code	Min.(nm)	Max.(nm)
RB	619	624

Green

Bin Code	Min.(nm)	Max.(nm)
G7	520	525
G23	522.5	527.5
G8	525	530
G45	527.5	532.5
G9	530	535

Blue

Bin Code	Min.(nm)	Max.(nm)
B3	460	465
B23	462.5	467.5
B4	465	470
B45	467.5	472.5
B5	470	475

Tolerance of measurement of dominant wavelength is ± 1 nm.

CRI BIN LIMIT (RED $I_F = 100\text{mA}$, GREEN $I_F = 100\text{mA}$, BLUE $I_F = 100\text{mA}$, WHITE $I_F = 100\text{mA}$)

Bin Code	CRI Min.	CRI Max.
A	65	70
C	70	75
D	75	80
H	80	85
J	85	90

Tolerance of measurement of CRI is ± 2 .

COLOR BIN LIMIT (RED $I_F = 100\text{mA}$, GREEN $I_F = 100\text{mA}$, BLUE $I_F = 100\text{mA}$, WHITE $I_F = 100\text{mA}$)

White

Bin Code	Sub-bins	x	y	Bin Code	Sub-bins	x	y	Bin Code	Sub-bins	x	y	Bin Code	Sub-bins	x	y			
XA	A11	0.3146	0.3172	XA	A31	0.3245	0.3515	SB	4C3	0.3663	0.3758	SB	5T4	0.3937	0.4001			
		0.3201	0.3222			0.3311	0.3574			0.3680	0.3833			0.3962	0.4086			
		0.3211	0.3106			0.3311	0.3449			0.3736	0.3874			0.4035	0.4133			
		0.3161	0.3059			0.3251	0.3394			0.3719	0.3797			0.4006	0.4044			
	A12	0.3130	0.3284		A32	0.3240	0.3636		4C4	0.3646	0.368		5A1	0.3670	0.3578	5A2	0.3670	0.3578
		0.3190	0.3339			0.3311	0.3699			0.3663	0.3758			0.3686	0.3649			
		0.3201	0.3222			0.3311	0.3574			0.3719	0.3797			0.3744	0.3685			
	A13	0.3146	0.3172		A33	0.3245	0.3515		4D3	0.3702	0.3722		5A3	0.3726	0.3612	5A4	0.3726	0.3612
		0.3190	0.3339			0.3311	0.3699			0.3630	0.3611			0.3686	0.3649			
		0.3251	0.3394			0.3381	0.3762			0.3646	0.368			0.3702	0.3722			
	A14	0.3256	0.3273		A34	0.3376	0.3633		4D4	0.3702	0.3722		5A4	0.3763	0.3760	5B1	0.3763	0.3760
		0.3201	0.3222			0.3311	0.3574			0.3686	0.3649			0.3744	0.3685			
		0.3256	0.3273			0.3376	0.3633			0.3614	0.3539			0.3744	0.3685			
	A21	0.3261	0.3152		A41	0.3371	0.3504		4T4	0.3680	0.3833		5A4	0.3763	0.3760	5B2	0.3763	0.3760
		0.3211	0.3106			0.3311	0.3449			0.3670	0.3578			0.3825	0.3798			
		0.3115	0.3397			0.3256	0.3273			0.3754	0.3954			0.3804	0.3721			
	A22	0.3180	0.3456		A42	0.3311	0.3324		5S1	0.3736	0.3874		5B3	0.3726	0.3612	5B3	0.3726	0.3612
		0.3190	0.3339			0.3311	0.3199			0.3698	0.3915			0.3744	0.3685			
		0.3130	0.3284			0.3261	0.3152			0.3754	0.3954			0.3804	0.3721			
	A23	0.3099	0.3509		A43	0.3251	0.3394		5S4	0.3736	0.3874		5B3	0.3783	0.3646	5B3	0.3783	0.3646
		0.3170	0.3572			0.3311	0.3449			0.3802	0.3916			0.3702	0.3722			
		0.3180	0.3456			0.3311	0.3324			0.3754	0.3954			0.3719	0.3797			
	A24	0.3115	0.3397		A44	0.3256	0.3273		5T1	0.3820	0.3997		5B3	0.3782	0.3837	5B3	0.3782	0.3837
		0.3170	0.3572			0.3311	0.3449			0.3871	0.3959			0.3763	0.3760			
		0.3180	0.3456			0.3256	0.3273			0.3802	0.3916			0.3719	0.3797			
	A24	0.3245	0.3515		A44	0.3311	0.3324		5T1	0.3820	0.3997		5B3	0.3736	0.3874	5B3	0.3736	0.3874
		0.3245	0.3515			0.3366	0.3374			0.3894	0.4044			0.3802	0.3916			
		0.3251	0.3394			0.3311	0.3324			0.3871	0.3959			0.3802	0.3916			
	A24	0.3180	0.3456		A44	0.3366	0.3374		5T1	0.3962	0.4086		5B3	0.3782	0.3837	5B3	0.3782	0.3837
		0.3245	0.3515			0.3361	0.3245			0.3937	0.4001			0.3802	0.3916			
		0.3190	0.3339			0.3311	0.3199			0.3937	0.4001			0.3869	0.3958			
	A24	0.3190	0.3339		A44	0.3311	0.3199		5T1	0.3937	0.4001		5B3	0.3847	0.3877	5B3	0.3847	0.3877
		0.3190	0.3339			0.3311	0.3199			0.3937	0.4001			0.3869	0.3958			
		0.3190	0.3339			0.3311	0.3199			0.3937	0.4001			0.3847	0.3877			

• Tolerance of measurement of the color coordinates is ± 0.01 .

Bin Code	Sub-bins	x	y	Bin Code	Sub-bins	x	y	Bin Code	Sub-bins	x	y	Bin Code	Sub-bins	x	y					
SB	5B4	0.3763	0.3760	SC	6C3	0.4186	0.4037	SC	7A1	0.4147	0.3814	SC	7C1	0.4342	0.4028					
		0.3782	0.3837			0.4222	0.4127			0.4183	0.3898			0.4385	0.4119					
		0.3847	0.3877			0.4299	0.4165			0.4242	0.3919			0.4449	0.4141					
		0.3825	0.3798			0.4259	0.4073			0.4203	0.3833			0.4403	0.4049					
	5C1	0.3825	0.3798		6C4	0.4150	0.3950		7A2	0.4183	0.3898		7C2	0.4385	0.4119	7C2	0.4430	0.4212		
		0.3847	0.3877			0.4186	0.4037			0.4221	0.3984			0.4496	0.4236					
		0.3912	0.3917			0.4259	0.4073			0.4281	0.4006			0.4449	0.4141					
		0.3887	0.3836			0.4221	0.3984			0.4242	0.3919			0.4449	0.4141					
	5C2	0.3847	0.3877		6D3	0.4116	0.3865		7A3	0.4242	0.3919		7C3	0.4449	0.4141	7C3	0.4496	0.4236		
		0.3869	0.3958			0.4150	0.3950			0.4281	0.4006			0.4562	0.4260					
		0.3937	0.4001			0.4221	0.3984			0.4342	0.4028			0.4513	0.4164					
		0.3912	0.3917			0.4183	0.3898			0.4300	0.3939			0.4403	0.4049					
	5C3	0.3912	0.3917		6D4	0.4082	0.3782		7A4	0.4203	0.3833		7C4	0.4449	0.4141	7C4	0.4513	0.4164		
		0.3937	0.4001			0.4116	0.3865			0.4242	0.3919			0.4465	0.4071					
		0.4006	0.4044			0.4183	0.3898			0.4300	0.3939			0.4259	0.3853					
		0.3978	0.3958			0.4147	0.3814			0.4259	0.3853			0.4300	0.3939					
	5C4	0.3887	0.3836		6T4	0.4222	0.4127		7B1	0.4221	0.3984		7D1	0.4259	0.3853	7D1	0.4359	0.3960		
		0.3912	0.3917			0.4265	0.4220			0.4259	0.4073			0.4316	0.3873					
		0.3978	0.3958			0.4340	0.4260			0.4322	0.4096			0.4300	0.3939					
		0.3950	0.3875			0.4299	0.4165			0.4281	0.4006			0.4359	0.3960					
	5D1	0.3783	0.3646		7S1	0.4299	0.4165		7B2	0.4259	0.4073		7D2	0.4300	0.3939	7D2	0.4342	0.4028		
		0.3804	0.3721			0.4340	0.4260			0.4299	0.4165			0.4403	0.4049					
		0.3863	0.3758			0.4406	0.4284			0.4364	0.4188			0.4359	0.3960					
		0.3840	0.3681			0.4364	0.4188			0.4322	0.4096			0.4403	0.4049					
	5D2	0.3804	0.3721		7S4	0.4364	0.4188		7B3	0.4322	0.4096		7D3	0.4359	0.3960	7D3	0.4403	0.4049		
		0.3825	0.3798			0.4406	0.4284			0.4364	0.4188			0.4465	0.4071					
		0.3887	0.3836			0.4477	0.4310			0.4430	0.4212			0.4418	0.3981					
		0.3863	0.3758			0.4430	0.4212			0.4385	0.4119			0.4316	0.3873					
	5D3	0.3863	0.3758		7T1	0.4430	0.4212		7B4	0.4281	0.4006		7D4	0.4316	0.3873	7D4	0.4359	0.3960		
		0.3887	0.3836			0.4477	0.4310			0.4322	0.4096			0.4418	0.3981					
		0.3950	0.3875			0.4543	0.4334			0.4385	0.4119			0.4418	0.3981					
		0.3924	0.3794			0.4496	0.4236			0.4342	0.4028			0.4373	0.3893					
	5D4	0.3840	0.3681		7T4	0.4496	0.4236													
		0.3863	0.3758			0.4543	0.4334													
		0.3924	0.3794			0.4614	0.4360													
		0.3898	0.3716			0.4562	0.4260													

• Tolerance of measurement of the color coordinates is ± 0.01 .

Bin Code	Sub-bins	x	y	Bin Code	Sub-bins	x	y
XD	D11	0.3371	0.3504	XD	D31	0.3525	0.3860
		0.3433	0.3546			0.3596	0.3908
		0.3423	0.3413			0.3576	0.3769
		0.3366	0.3374			0.3509	0.3724
	D12	0.3376	0.3633		D32	0.3541	0.3996
		0.3443	0.3678			0.3616	0.4047
		0.3433	0.3546			0.3596	0.3908
		0.3371	0.3504			0.3525	0.3860
	D13	0.3443	0.3678		D33	0.3616	0.4047
		0.3509	0.3724			0.3693	0.4099
		0.3494	0.3588			0.3668	0.3957
		0.3433	0.3546			0.3596	0.3908
	D14	0.3433	0.3546		D34	0.3596	0.3908
		0.3494	0.3588			0.3668	0.3957
		0.3479	0.3453			0.3643	0.3815
		0.3423	0.3413			0.3576	0.3769
	D21	0.3381	0.3762		D41	0.3494	0.3588
		0.3453	0.3811			0.3556	0.3631
		0.3443	0.3678			0.3536	0.3492
		0.3376	0.3633			0.3479	0.3453
	D22	0.3386	0.3891		D42	0.3509	0.3724
		0.3463	0.3944			0.3576	0.3769
		0.3453	0.3811			0.3556	0.3631
		0.3381	0.3762			0.3494	0.3588
	D23	0.3463	0.3944		D43	0.3576	0.3769
		0.3541	0.3996			0.3643	0.3815
		0.3525	0.3860			0.3618	0.3673
		0.3453	0.3811			0.3556	0.3631
	D24	0.3453	0.3811		D44	0.3556	0.3631
		0.3525	0.3860			0.3618	0.3673
		0.3509	0.3724			0.3592	0.3531
		0.3443	0.3678			0.3536	0.3492

- Tolerance of measurement of the color coordinates is ± 0.01 .

CIE CHROMATICITY DIAGRAM

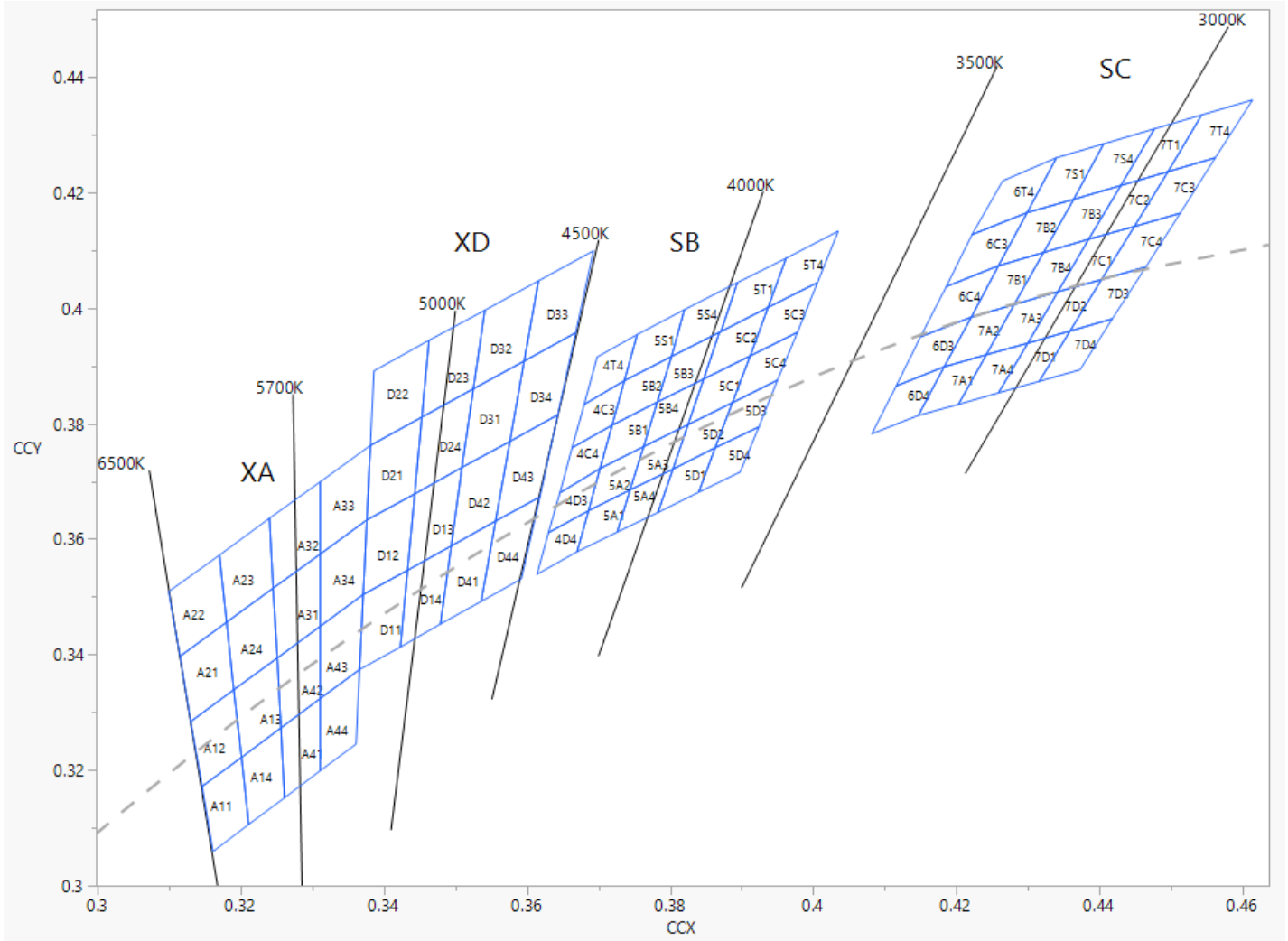

ORDER CODE TABLE*

Kit Number	Color	Luminous Intensity (mcd)		Dominant Wavelength (nm)				Pack- age
		Min.	Max.	Color Bin	Min. (nm)	Color Bin	Max. (nm)	
CLQ6A-TKW-S1L1R1H1QBB7935AA3	Red	Any 1 Intensity bin from 1L(3000) - 1N(5860)		RB	619	RB	624	Reel
	Green	Any 1 Intensity bin from 1R(7030) - 1T(14400)		Any 1 hue bin from G7(520) - G9(535)				Reel
	Blue	Any 1 Intensity bin from 1H(1824) - 1L(4180)		Any 1 hue bin from B3(460) - B5(475)				Reel
	White	Any 1 Intensity bin from 1Q(5860) - 1S(12000)		XA				Reel
CLQ6A-TKW-S1L1R1H1QBB7935BB3	Red	Any 1 Intensity bin from 1L(3000) - 1N(5860)		RB	619	RB	624	Reel
	Green	Any 1 Intensity bin from 1R(7030) - 1T(14400)		Any 1 hue bin from G7(520) - G9(535)				Reel
	Blue	Any 1 Intensity bin from 1H(1824) - 1L(4180)		Any 1 hue bin from B3(460) - B5(475)				Reel
	White	Any 1 Intensity bin from 1Q(5860) - 1S(12000)		SB				Reel
CLQ6A-TKW-S1L1R1H1QBB7935CC3	Red	Any 1 Intensity bin from 1L(3000) - 1N(5860)		RB	619	RB	624	Reel
	Green	Any 1 Intensity bin from 1R(7030) - 1T(14400)		Any 1 hue bin from G7(520) - G9(535)				Reel
	Blue	Any 1 Intensity bin from 1H(1824) - 1L(4180)		Any 1 hue bin from B3(460) - B5(475)				Reel
	White	Any 1 Intensity bin from 1Q(5860) - 1S(12000)		SC				Reel
CLQ6A-TKW-S1L1R1H1QBB7935DD3	Red	Any 1 Intensity bin from 1L(3000) - 1N(5860)		RB	619	RB	624	Reel
	Green	Any 1 Intensity bin from 1R(7030) - 1T(14400)		Any 1 hue bin from G7(520) - G9(535)				Reel
	Blue	Any 1 Intensity bin from 1H(1824) - 1L(4180)		Any 1 hue bin from B3(460) - B5(475)				Reel
	White	Any 1 Intensity bin from 1Q(5860) - 1S(12000)		XD				Reel

Notes:

1. The above kit numbers represent the order codes which include multiple intensity-bin and color-bin codes. Only one intensity-bin code and one color-bin code will be shipped on each reel. Single intensity-bin code and single color-bin code will be orderable in certain quantities. For example, any 1 intensity bin from 1R - 1T means only 1 intensity bin (1R or 1S or 1T) will be shipped by Cree. For example, any 1 color bin from G7 - G9 means only 1 color bin (G7 or G23 or G8 or G45 or G9) will be shipped by Cree.
2. Please refer to the "Cree LED Lamp Reliability Test Standards" document #1 for reliability test conditions.
3. Please refer to the "Cree LED Lamp Soldering & Handling" document #2 for information about how to use this LED product safely.

#1: Refer to http://www.cree.com/led-components/media/documents/LED_Lamp_Reliability_Test_Standard.pdf

#2: Refer to <http://www.cree.com/led-components/media/documents/sh-HB.pdf>

GRAPHS

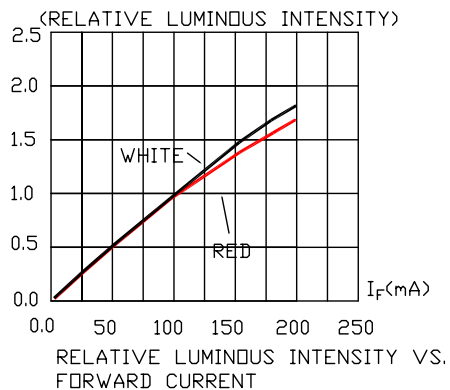
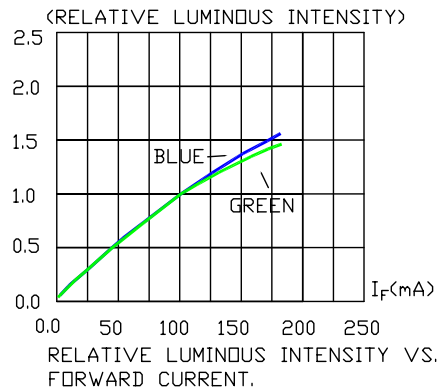
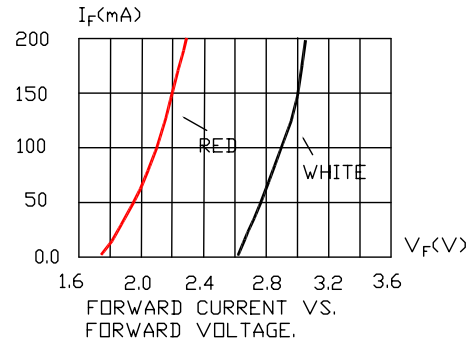
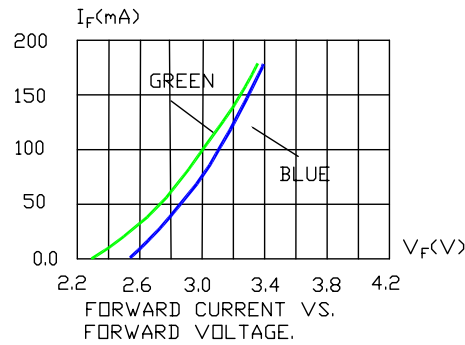
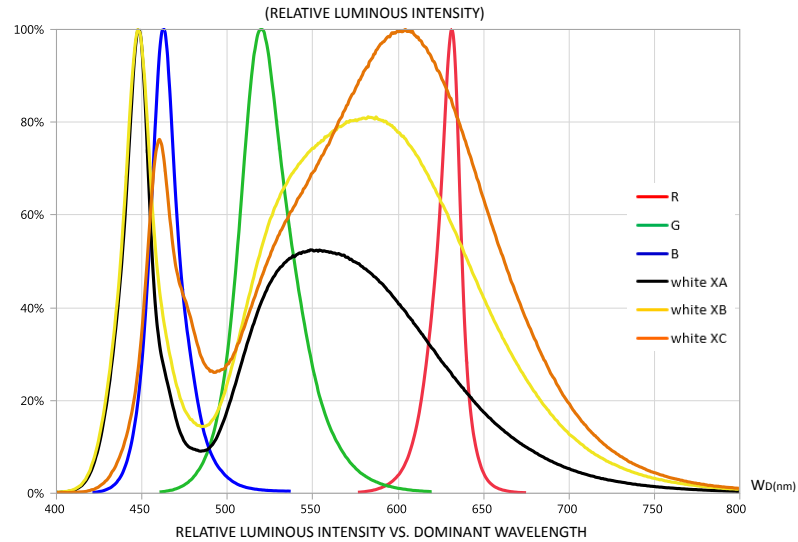

The above data are collected from statistical figures that do not necessarily correspond to the actual parameters of each single LED. Hence, these data will be changed without further notice.

GRAPHS

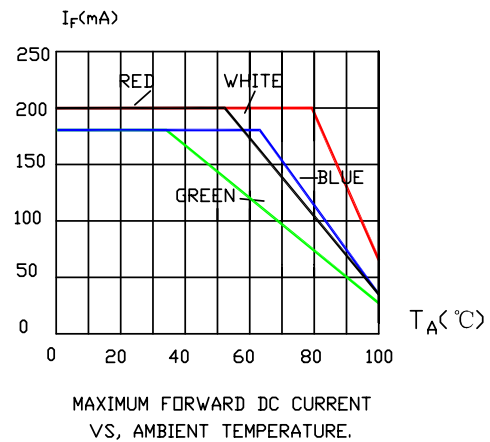
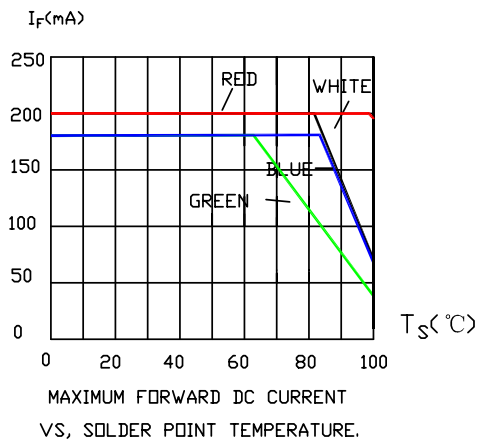
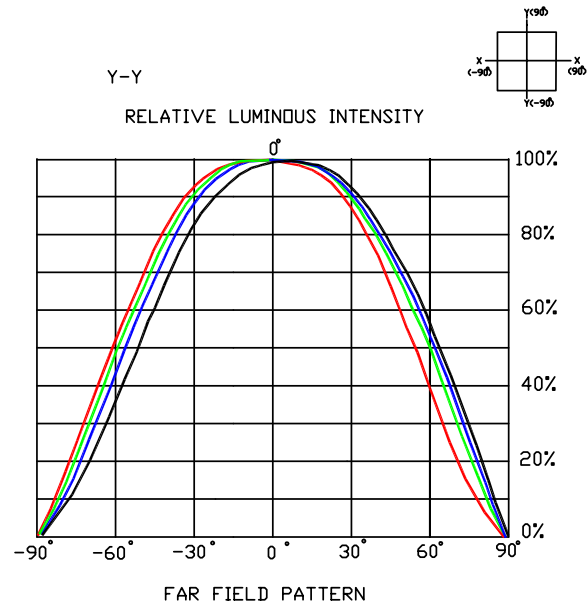
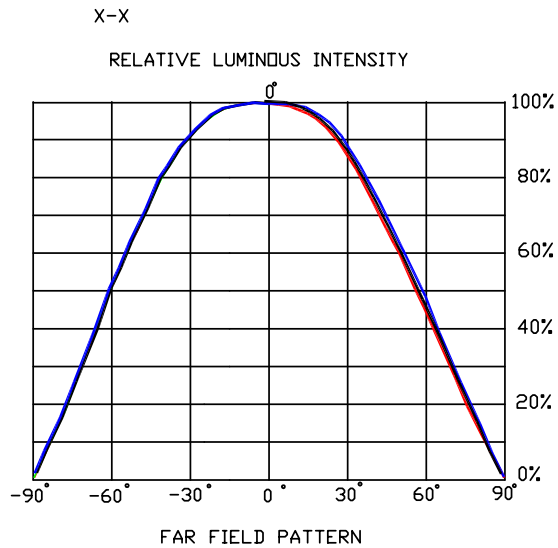

The graph shows the maximum allowable DC current for a LED die of each color.

The above data are collected from statistical figures that do not necessarily correspond to the actual parameters of each single LED. Hence, these data will be changed without further notice.

MECHANICAL DIMENSIONS

All dimensions are in mm.

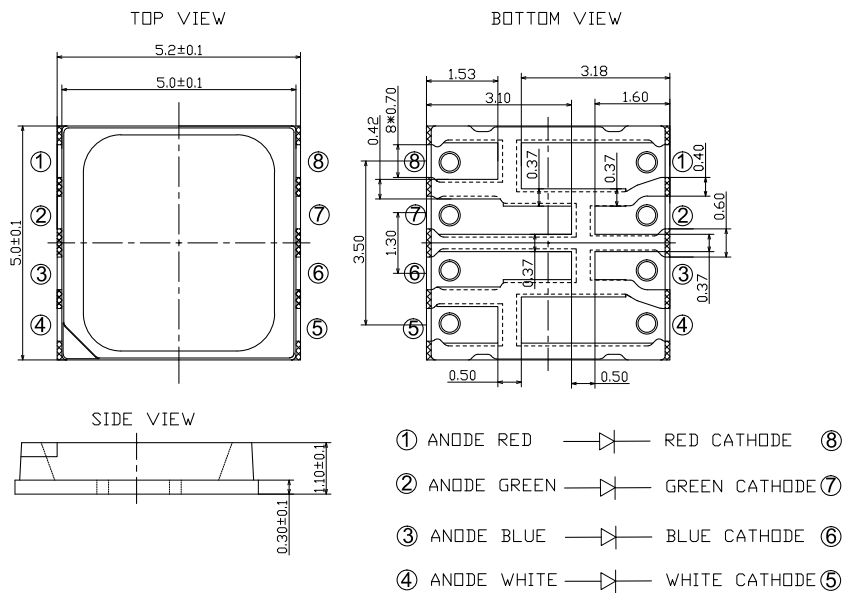

- Tolerance of measurement of the dimension is ± 0.1 .

NOTES

RoHS Compliance

The levels of RoHS-restricted materials in this product are below the maximum concentration values (also referred to as the threshold limits) permitted for such substances, or are used in an exempted application in accordance with EU Directive 2011/65/EC (RoHS2), as implemented by EU member states on January 2, 2013 and amended on March 31, 2015 by EU Directive 2015/863/EU.

RoHS Declarations for this product can be obtained from your Cree representative or from the Product Ecology section of the Cree website.

Vision Advisory Claim

Users should be cautioned not to stare at the light of this LED product. The bright light can damage the eye.

Solder Pad recommend:

All dimensions are in mm.

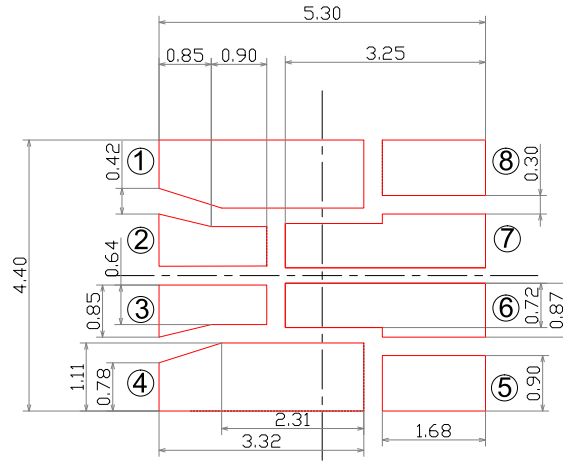

- Tolerance of measurement of the dimension is ± 0.1 .

Assembly notes:

- Modification of an SMD LED is not recommended after soldering. If modification cannot be avoided, the modifications must be pre-qualified to avoid damaging the SMD LED.
- Reflow soldering should not be done more than two times (according to model's MSL requirements).
- No stress should be exerted on the package during soldering.
- The package may be affected by environments & assemblies which contain corrosive substance. Please avoid conditions which may cause the LEDs to corrode, tarnish, or discolor.
- The PCB should not be wrapped after soldering to allow natural cooling down to 40°.

KIT NUMBER SYSTEM

Cree LED lamps are tested and sorted into performance bins. A bin is specified by ranges of color, forward voltage, and brightness. Sorted LEDs are packaged for shipping in various convenient options. Please refer to the "Cree LED Lamp Packaging Standard" document for more information about shipping and packaging options.

Cree LEDs are sold by order codes in combinations of bins called kits. Order codes are configured in the following manner:

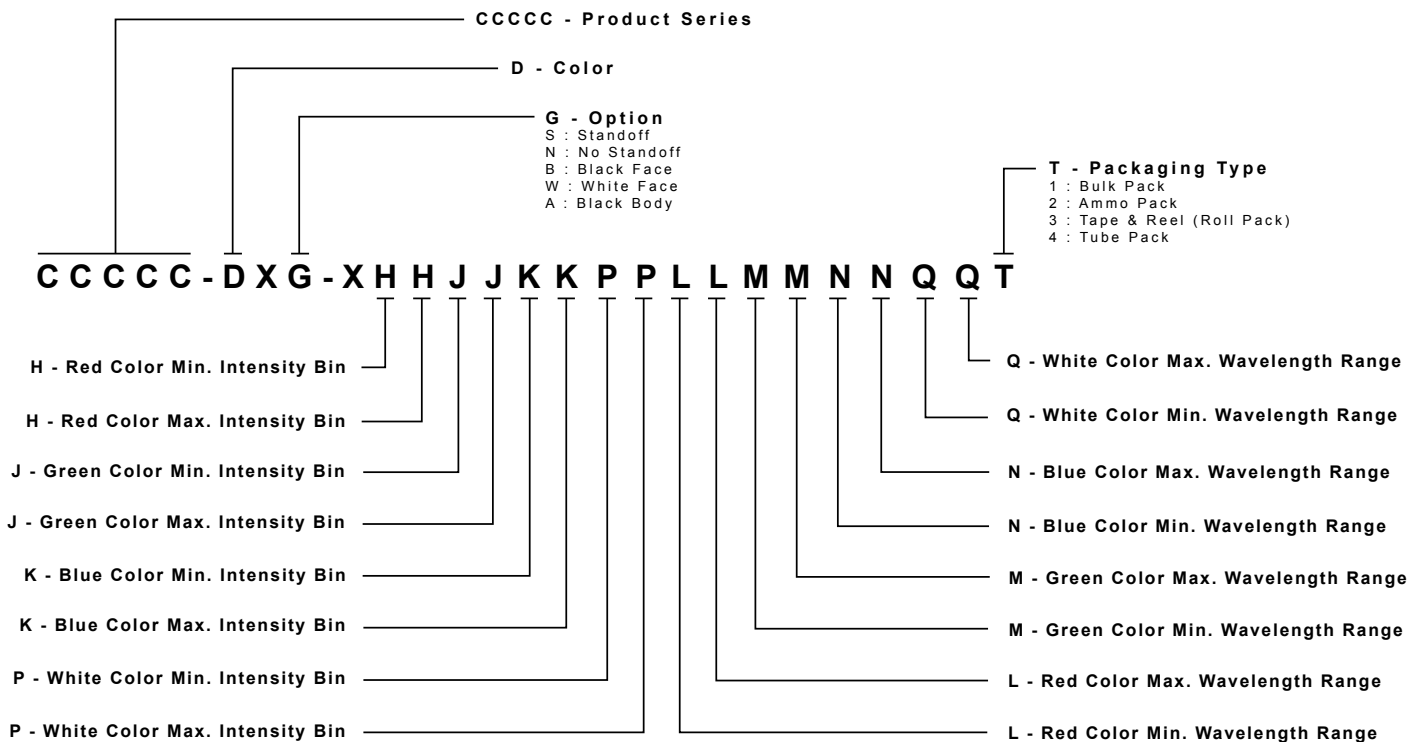

REFLOW SOLDERING

- The CLQ6A-TKW is rated as a MSL 5a product.
- The recommended floor life out of bag is 24hrs.
- The temperature profile is as below.

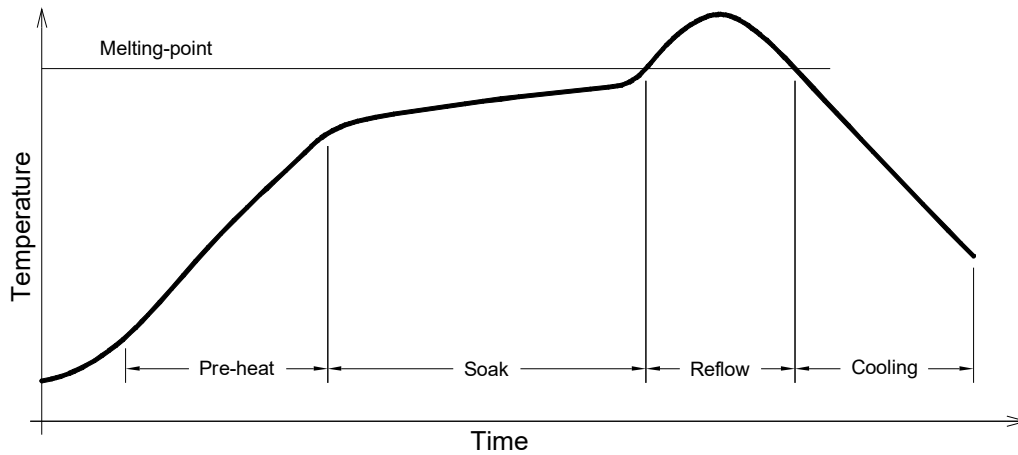

Use only with CLQ6A-TKW

Solder
Average ramp-up rate = 4°C/s max
Preheat temperature = 150°C ~200°C
Preheat time = 120s max
Ramp-down rate = 6°C/s max
Peak temperature = 250°C max
Time within 5°C of actual Peak Temperature = 10s max
Duration above 217°C is 60s max

Refer to "<http://www.cree.com/led-components/media/documents/sh-HB.pdf>" for soldering & handling details.

NOTES

- The packaging sizes of these SMD products are very small and the resin is still soft after solidification. Users are required to handle with care. Never touch the resin surface of SMD products.
- To avoid damaging the product's surface and interior device, it is recommended to choose a special nozzle to pick up the SMD products during the process of SMT production. If handling is necessary, take special care when picking up these products. The following method is necessary:

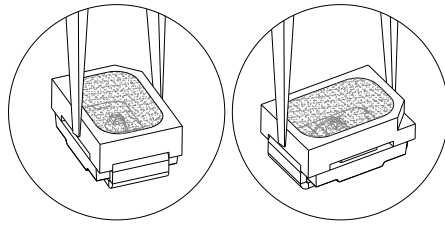

PACKAGING

- The boxes are not water resistant and they must be kept away from water and moisture.
- The LEDs are packed in cardboard boxes after packaging in normal or anti-electrostatic bags.
- Cardboard boxes will be used to protect the LEDs from mechanical shocks during transportation.
- The reel pack is applied in SMD LED.
- Max 4000 pcs per reel.

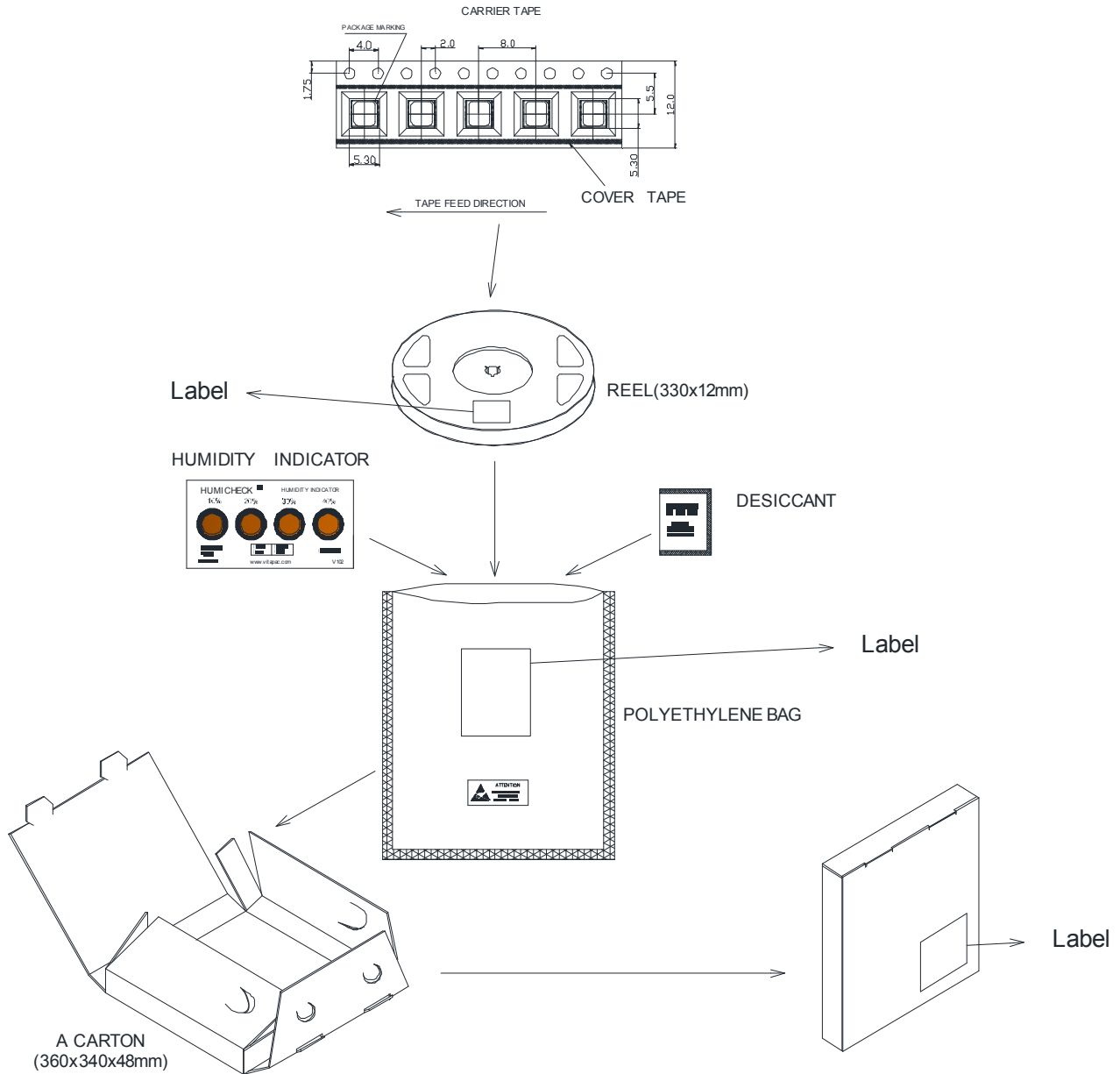

Компания «Океан Электроники» предлагает заключение долгосрочных отношений при поставках импортных электронных компонентов на взаимовыгодных условиях!

Наши преимущества:

- Поставка оригинальных импортных электронных компонентов напрямую с производств Америки, Европы и Азии, а так же с крупнейших складов мира;
- Широкая линейка поставок активных и пассивных импортных электронных компонентов (более 30 млн. наименований);
- Поставка сложных, дефицитных, либо снятых с производства позиций;
- Оперативные сроки поставки под заказ (от 5 рабочих дней);
- Экспресс доставка в любую точку России;
- Помощь Конструкторского Отдела и консультации квалифицированных инженеров;
- Техническая поддержка проекта, помощь в подборе аналогов, поставка прототипов;
- Поставка электронных компонентов под контролем ВП;
- Система менеджмента качества сертифицирована по Международному стандарту ISO 9001;
- При необходимости вся продукция военного и аэрокосмического назначения проходит испытания и сертификацию в лаборатории (по согласованию с заказчиком);
- Поставка специализированных компонентов военного и аэрокосмического уровня качества (Xilinx, Altera, Analog Devices, Intersil, Interpoint, Microsemi, Actel, Aeroflex, Peregrine, VPT, Syfer, Eurofarad, Texas Instruments, MS Kennedy, Miteq, Cobham, E2V, MA-COM, Hittite, Mini-Circuits, General Dynamics и др.);

Компания «Океан Электроники» является официальным дистрибьютором и эксклюзивным представителем в России одного из крупнейших производителей разъемов военного и аэрокосмического назначения «JONHON», а так же официальным дистрибьютором и эксклюзивным представителем в России производителя высокотехнологичных и надежных решений для передачи СВЧ сигналов «FORSTAR».



JONHON

«JONHON» (основан в 1970 г.)

Разъемы специального, военного и аэрокосмического назначения:

(Применяются в военной, авиационной, аэрокосмической, морской, железнодорожной, горно- и нефтедобывающей отраслях промышленности)

«FORSTAR» (основан в 1998 г.)

ВЧ соединители, коаксиальные кабели, кабельные сборки и микроволновые компоненты:

(Применяются в телекоммуникациях гражданского и специального назначения, в средствах связи, РЛС, а так же военной, авиационной и аэрокосмической отраслях промышленности).



Телефон: 8 (812) 309-75-97 (многоканальный)

Факс: 8 (812) 320-03-32

Электронная почта: ocean@oceanchips.ru

Web: <http://oceanchips.ru/>

Адрес: 198099, г. Санкт-Петербург, ул. Калинина, д. 2, корп. 4, лит. А