

LOW VOLTAGE DETECTOR WITH OUTPUT DELAY R3112xxx1A/C Series

■ OUTLINE

The R3112 Series are voltage detector ICs with high detector threshold accuracy and ultra-low supply current by CMOS process, which can be operated at an extremely low voltage and is used for system reset as an example.

Each of these ICs consists of a voltage reference unit, a comparator, resistor net for detector threshold setting, an output driver, a hysteresis circuit, and an output delay circuit. The detector threshold is fixed with high accuracy internally and does not require any adjustment. Two output types, Nch open drain type and CMOS type are available.

Two types of packages, SOT-23-5 and ultra small SC-82AB can be selected so that high density mounting on boards is possible.

■ FEATURES

- Built-in Output Delay Circuit.....TYP. 100ms with an external capacitor: 0.022 μ F
- Ultra-low Supply Current.....TYP. 1.0 μ A (VDD=3.5V)
- Wide Range of Operating Voltage.....0.7~6.0V (T_{opt}=25°C)
- Detector Threshold.....Stepwise setting with a step of 0.1V in the range of 0.9V to 5.0V is possible.
- High Accuracy Detector Threshold..... \pm 2.0%
- Low Temperature-Drift Coefficient of Detector Threshold.....TYP. \pm 100ppm/°C
- Two Output Types.....Nch Open Drain and CMOS
- Two Types of Packages.....SOT-23-5 (Mini-mold), SC-82AB

■ APPLICATIONS

- CPU and Logic Circuit Reset
- Battery Checker
- Window Comparator
- Wave Shaping Circuit
- Battery Back-up Circuit
- Power Failure Detector

■ BLOCK DIAGRAMS

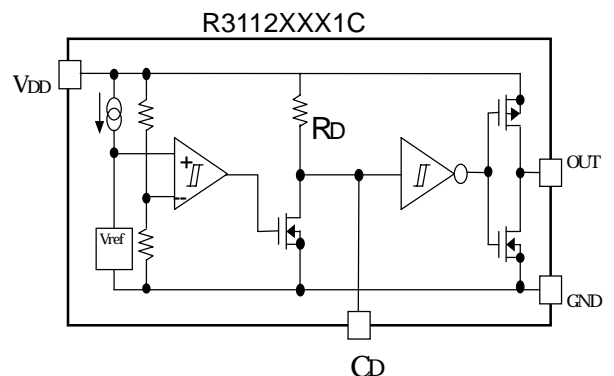
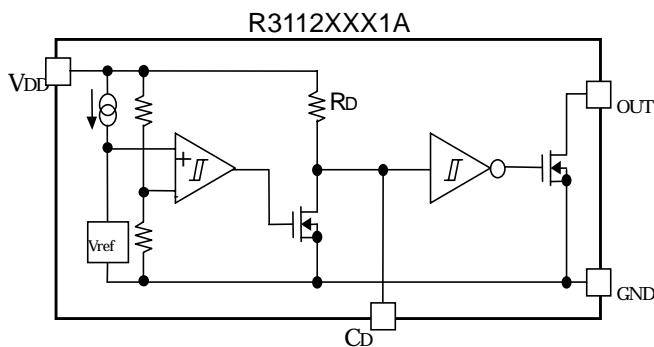

■ OPERATION

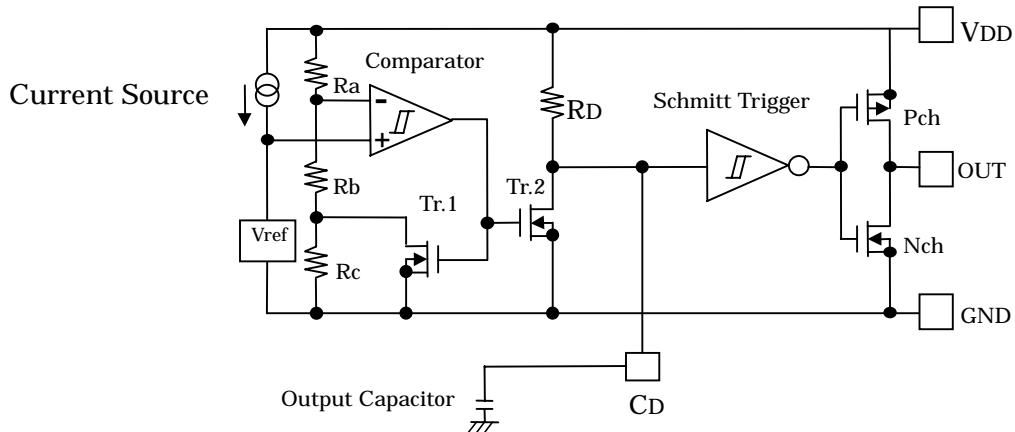

Fig. 1 Block Diagram with an external capacitor

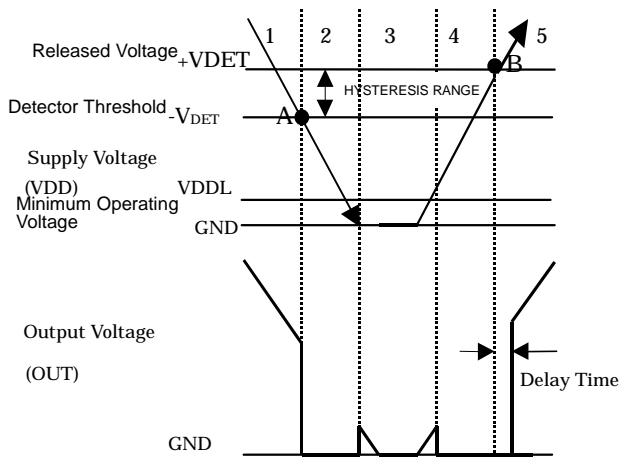

Fig. 2 Operation Diagram

Operation Status	1	2	3	4	5
Comparator(-) Pin Input Voltage	I	II	II	II	I
Comparator Output	L	H	Indefinite	H	L
Tr.1, 2	OFF	ON	Indefinite	ON	OFF
Output Tr.	Nch	OFF	ON	Indefinite	ON
	Pch	ON	OFF	Indefinite	OFF

$$I \quad \frac{R_b + R_c}{R_a + R_b + R_c} \times V_{DD}$$

$$II \quad \frac{R_b}{R_a + R_b} \times V_{DD}$$

1. Output Voltage is equal to Supply Voltage. (As for Nch Open Drain Type, equal to pull-up voltage.)
 2. When the Supply Voltage is down to the detector threshold voltage level(Point A), $V_{ref} \geq V_{DD} \times (R_b + R_c) / (R_a + R_b + R_c)$ is true, then output of the comparator is reversed from "L" to "H", therefore Output Voltage becomes GND level.
 3. When the Supply Voltage is lower than Minimum Operating Voltage, the operation of Output Transistor is indefinite. In the case of Nch Open Drain Type, Output Voltage is equal to pull-up Voltage.
 4. Output Voltage becomes GND level.
 5. When the Supply Voltage is higher than released voltage (Point B), $V_{ref} \leq V_{DD} \times R_b / (R_a + R_b)$ is true, then Output of the comparator reaches the threshold level, and Output of Schmitt Trigger is reversed from "H" to "L", then Output Voltage is equal to Supply Voltage. (As for Nch Open Drain Type, equal to pull-up voltage.)
- *) The difference between Released Voltage and Detector Threshold Voltage means Hysteresis Range Voltage.

● Operation of Output Delay

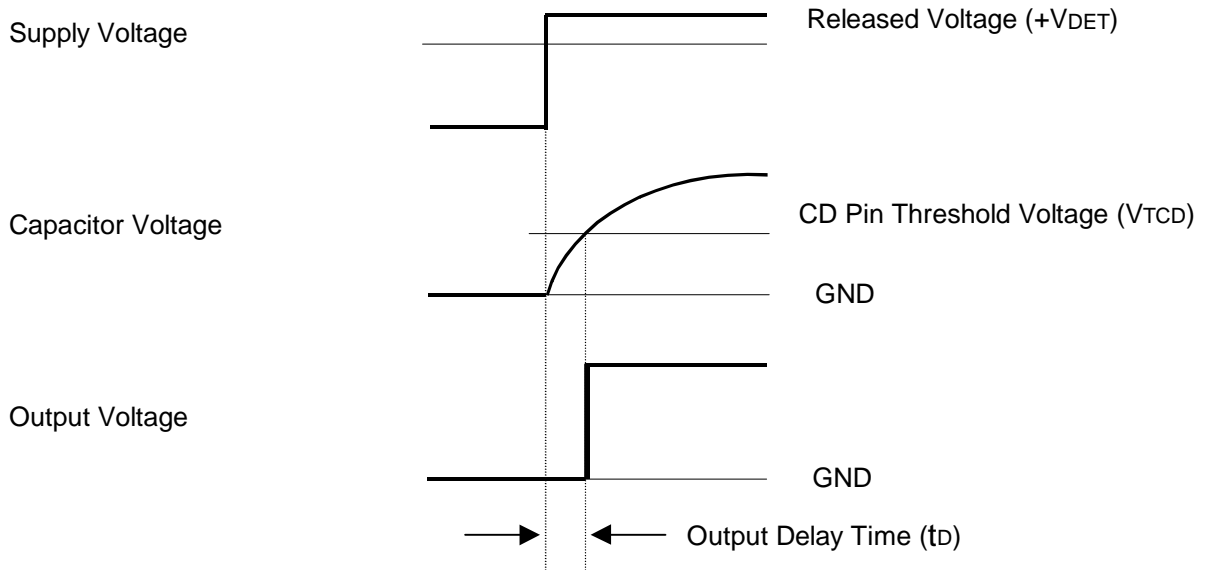

When the Supply Voltage which is higher than Released Voltage is forced to V_{DD} pin, charge to an external capacitor starts, then capacitor voltage increases. Until the capacitor voltage reaches to CD Pin Threshold Voltage, Output Voltage maintains "L". When the capacitor voltage becomes higher than CD pin threshold voltage, Output Voltage is reversed from "L" to "H". Where, the time interval between the rising edge of Supply Voltage and Output Voltage Reverse point means Output Delay Time.

● Output Delay Time

Output Delay Time (t_D) can be calculated with the next formula.

$$t_D = 0.69 \times R_D \times C_D (\text{s})$$

R_D is internal resistor and set at 6.5MΩ(TYP.) typically. C_D(F) describes the capacitance value of an external capacitor. Therefore,

$$t_D = 0.69 \times 6.5 \times 10^6 \times C_D (\text{s})$$

SELECTION GUIDE

The package type, the detector threshold, the output type, and the taping type of R3112 Series can be designated at the users' request by specifying the part number as follows;

R3112XXX1X-XX ← Part Number
 ↑↑ ↑↑
 a b c d

Code	Contents
a	Designation of Package Type; Q:SC-82AB N:SOT-23-5
b	Setting Detector Threshold (-VDET); Stepwise setting with a step of 0.1V in the range of 0.9V to 5.0V is possible.
c	Designation of Output Type; A: Nch Open Drain C: CMOS
d	Designation of Packing or Taping Type ; Ex. SOT-23-5, SC-82AB: TR is prescribed as standard directions. (Refer to Taping Specifications)

PIN CONFIGURATION

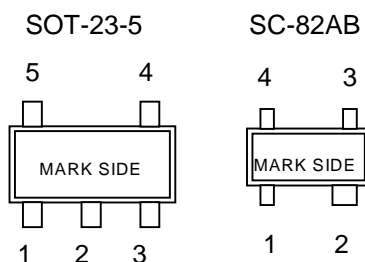

PIN DESCRIPTION

SOT-23-5		
Pin No.	Symbol	Description
1	OUT	Output Pin(Output "L" at detector threshold, Output "H" at released voltage)
2	VDD	Voltage Supply Pin
3	GND	Ground Pin
4	NC	No Connection
5	CD	Pin for External Capacitor (for setting output delay)

SC-82AB		
Pin No.	Symbol	Description
1	VDD	Voltage Supply Pin
2	GND	Ground Pin
3	CD	Pin for External Capacitor (for setting output delay)
4	OUT	Output Pin(Output "L" at detector threshold, Output "H" at released voltage)

■ABSOLUTE MAXIMUM RATINGS

Symbol	Item	Rating	Unit
VDD	Supply Voltage	6.5	V
VOUT1	Output Voltage(CMOS)	VSS-0.3~VDD+0.3	V
VOUT2	Output Voltage(Nch)	VSS-0.3~6.5	V
IOUT	Output Current	20	mA
Pd	Power Dissipation(SOT23-5)	250	mW
	Power Dissipation(SC82-AB)	150	
Topt	Operating Temperature Range	-40~85	°C
Tstg	Storage Temperature Range	-55~125	°C
Tsolder	Lead temperature (Soldering)	260°C, 10s	

ABSOLUTE MAXIMUM RATINGS

Absolute Maximum ratings are threshold limit values that must not be exceeded ever for an instant under any conditions. Moreover, such values for any two items must not be reached simultaneously. Operation above these absolute maximum ratings may cause degradation or permanent damage to the device. These are stress ratings only and do not necessarily imply functional operation below these limits.

●R3112x091A/C

Topt=25°C

Symbol	Item	Conditions	MIN.	TYP.	MAX.	Unit
-VDET	Detector Threshold		0.882	0.900	0.918	V
VHYS	Detector Threshold Hysteresis		0.027	0.045	0.063	V
ISS	Supply Current	VDD=0.80V		0.6	2.0	μA
		1.90V		0.5	2.0	
VDDH	Maximum Operating Voltage				6.0	V
VDDL	Minimum Operating Voltage*Note1	Topt=25°C			0.70	V
		-40°C ≤ Topt ≤ 85°C			0.80	
IOUT	Output Current (Driver Output Pin)	Nch VDS=0.05V, VDD=0.70V	10	120		μA
		VDS=0.50V, VDD=0.85V	0.05	0.9		mA
		Pch VDS=-2.1V, VDD=4.5V	1.0	3.5		mA
VTCD	CD pin Threshold Voltage	VDD=0.99V	0.297	0.495	0.693	V
ICD	CD pin Output Current	VDS=0.10V, VDD=0.70V	2	70		μA
		VDS=0.50V, VDD=0.85V	10	400		
RD	Output Delay Resistance		3.25	6.50	13.00	MΩ
Δ-VDET/ΔT	Detector Threshold Temperature Coefficient	-40°C ≤ Topt ≤ 85°C		±100		ppm/°C

●R3112x271A/C

T_{opt}=25°C

Symbol	Item	Conditions	MIN.	TYP.	MAX.	Unit
-VDET	Detector Threshold		2.646	2.700	2.754	V
VHYS	Detector Threshold Hysteresis		0.081		0.189	V
ISS	Supply Current	VDD=2.60V		1.0	2.5	μA
		3.70V		0.5	3.0	
VDDH	Maximum Operating Voltage				6.0	V
VDDL	Minimum Operating Voltage* ^{Note1}	T _{opt} =25°C			0.7	V
		-40°C ≤ T _{opt} ≤ 85°C			0.8	
IOUT	Output Current (Driver Output Pin)	Nch VDS=0.05V, VDD=0.70V	10	120		μA
		VDS=0.50V, VDD=1.50V	1.0	3.0		mA
		Pch VDS=-2.1V, VDD=4.5V	1.0	3.5		mA
VTCD	CD pin Threshold Voltage	VDD=2.97V	0.891	1.485	2.079	V
ICD	CD pin Output Current	VDS=0.1V, VDD=0.7V	2.0	70		μA
		VDS=0.5V, VDD=1.5V	200	500		
RD	Output Delay Resistance		3.25	6.50	13.00	MΩ
Δ-VDET/ΔT	Detector Threshold Temperature Coefficient	-40°C ≤ T _{opt} ≤ 85°C		±100		ppm/°C

●R3112x501A/C

T_{opt}=25°C

Symbol	Item	Conditions	MIN.	TYP.	MAX.	Unit
-VDET	Detector Threshold		4.900	5.000	5.100	V
VHYS	Detector Threshold Hysteresis		0.150	0.250	0.350	V
ISS	Supply Current	VDD=4.9V		1.5	2.5	μA
		6.0V		0.6	3.0	
VDDH	Maximum Operating Voltage				6.0	V
VDDL	Minimum Operating Voltage* ^{Note1}	T _{opt} =25°C			0.7	V
		-40°C ≤ T _{opt} ≤ 85°C			0.8	
IOUT	Output Current (Driver Output Pin)	Nch VDS=0.05V, VDD=0.70V	10	120		μA
		VDS=0.50V, VDD=1.50V	1.0	3.0		mA
		Pch VDS=-2.1V, VDD=6.0V	1.5	4.5		mA
VTCD	CD pin Threshold Voltage	VDD=2.97V	1.650	2.750	3.850	V
ICD	CD pin Output Current	VDS=0.1V, VDD=0.7V	2.0	70		μA
		VDS=0.5V, VDD=1.5V	200	500		
RD	Output Delay Resistance		3.25	6.50	13.00	MΩ
Δ-VDET/ΔT	Detector Threshold Temperature Coefficient	-40°C ≤ T _{opt} ≤ 85°C		±100		ppm/°C

*Note1: Minimum Operating Voltage means the value of input voltage when output voltage maintains 0.1V or less.

(In the case of Nch Open Drain Type, Output pin is pulled up with a resistance of 470kΩ to 5.0V.)

■ TEST CIRCUITS

*Pull-up circuit is not necessary for CMOS Output type, or R3112XXXXC.

Supply Current Test Circuit

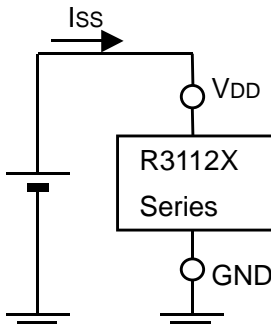

Nch Driver Output Current Test Circuit

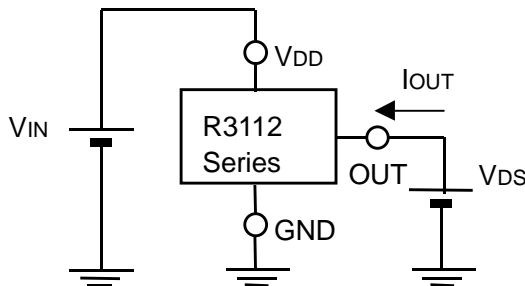

CD Pin Threshold Test Circuit

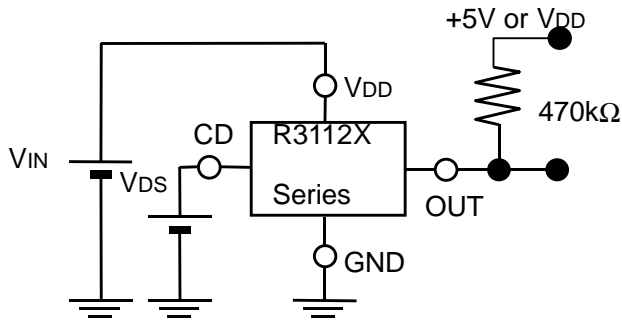

Output Delay Time Test Circuit

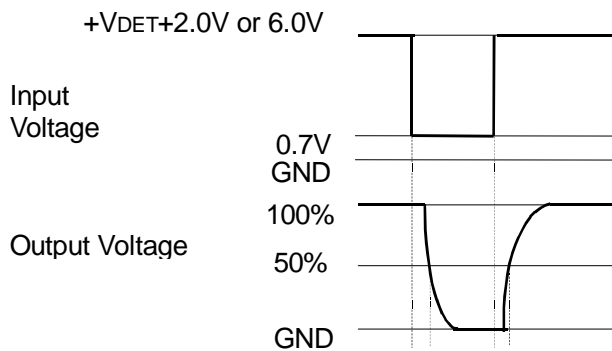

Detector Threshold Test Circuit

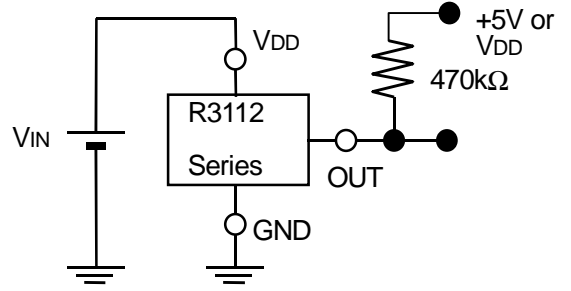

Pch Driver Output Current Test Circuit *Apply only to CMOS

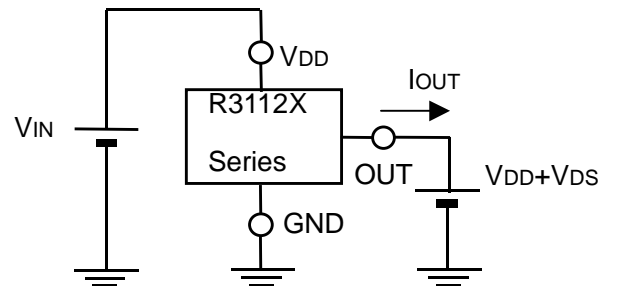

CD Pin Output Current Test Circuit

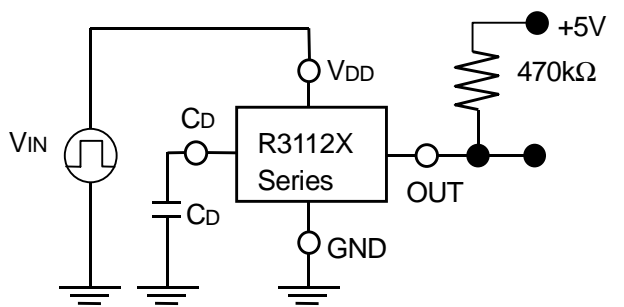
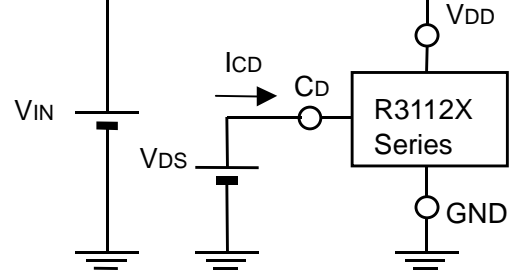

■ TYPICAL CHARACTERISTICS

1) Supply Current vs. Input Voltage

R3112X091X

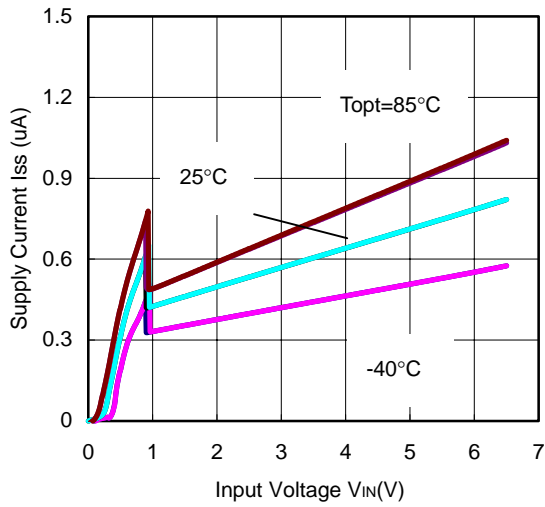

R3112X131X

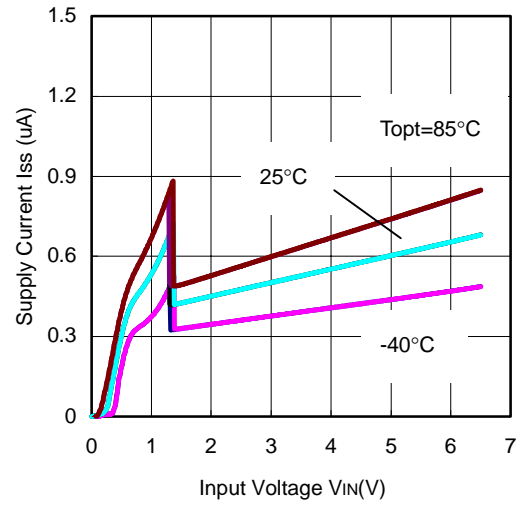

R3112X271X

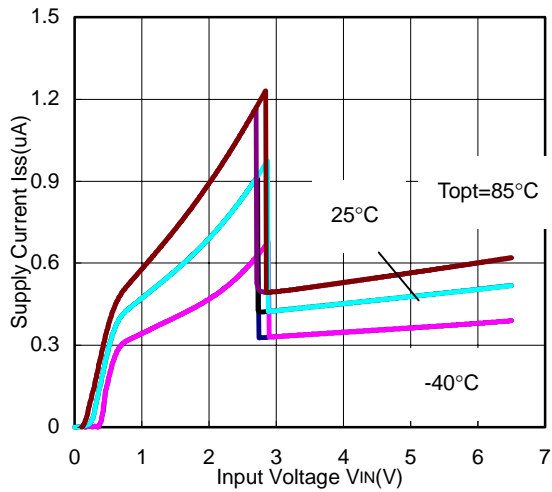

R3112X451X

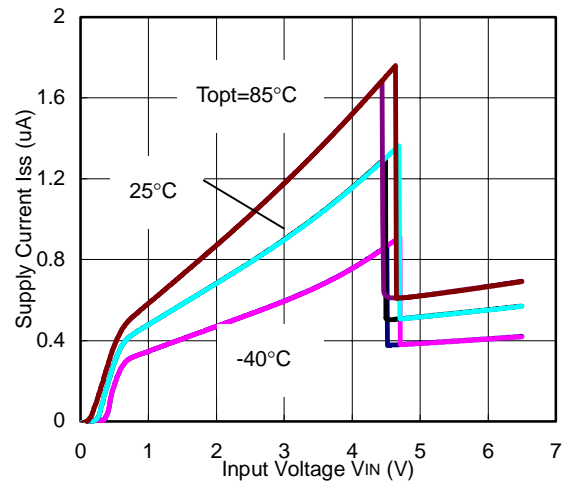

2) Detector Threshold vs. Temperature

R3112X091X

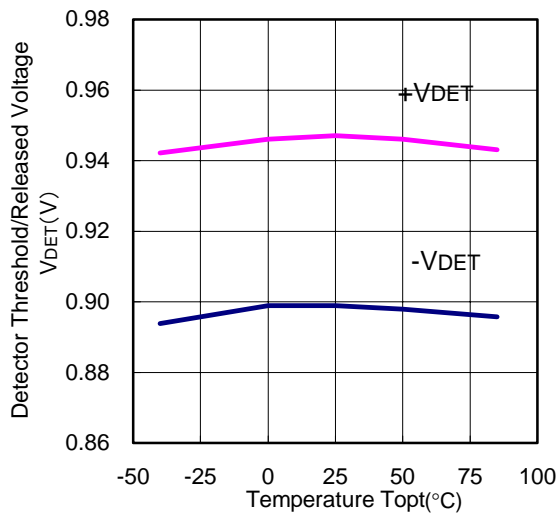

R3112X131X

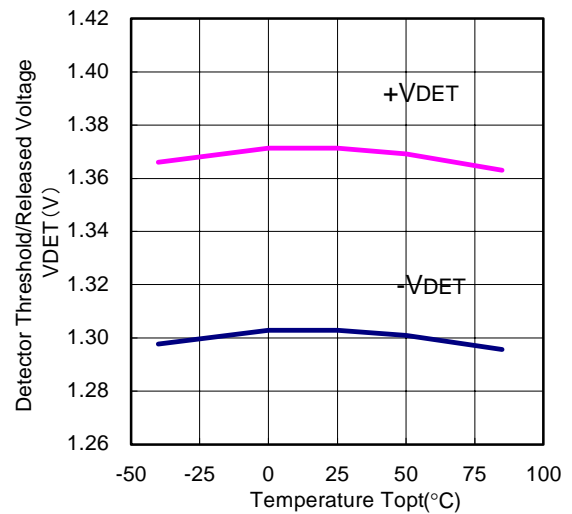

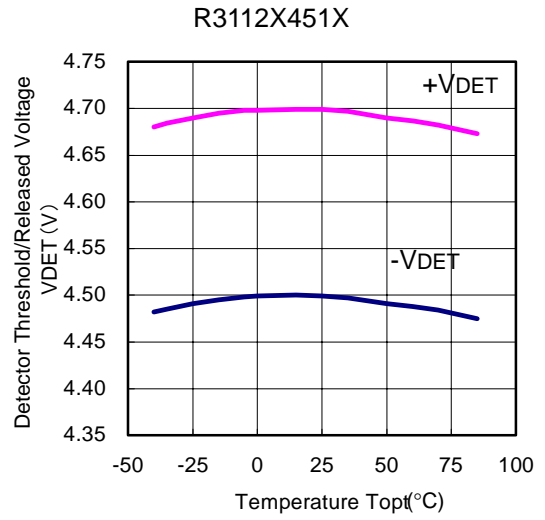
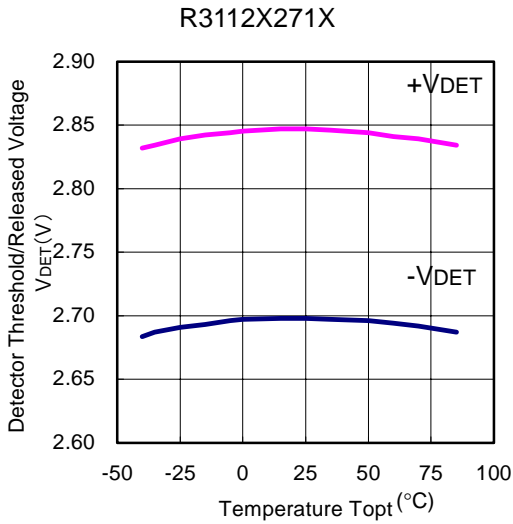

3) Output Voltage vs. Input Voltage

R3112X091X

Nch Output Type: VDD pull up

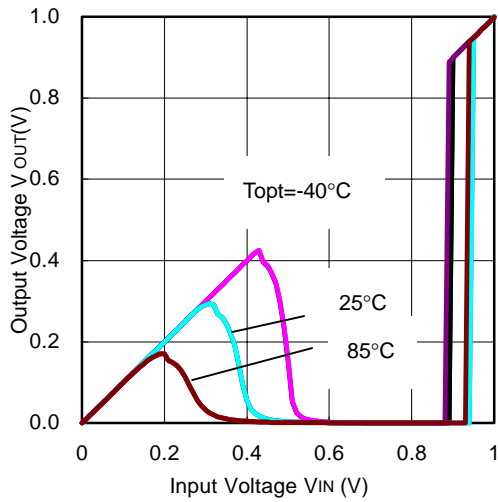

R3112X091A

5V pull up via 470kΩ

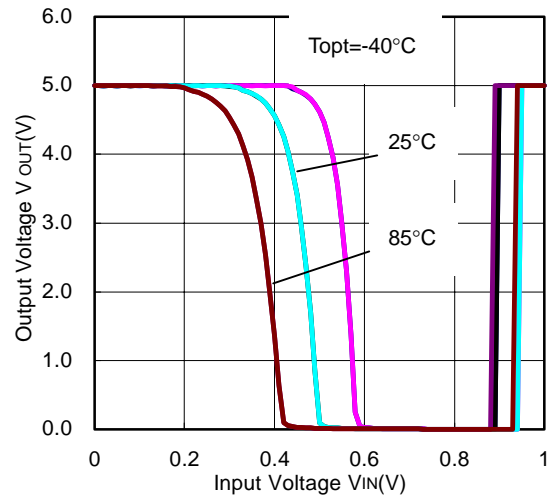

R3112X131X

Nch Output Type: VDD pull up

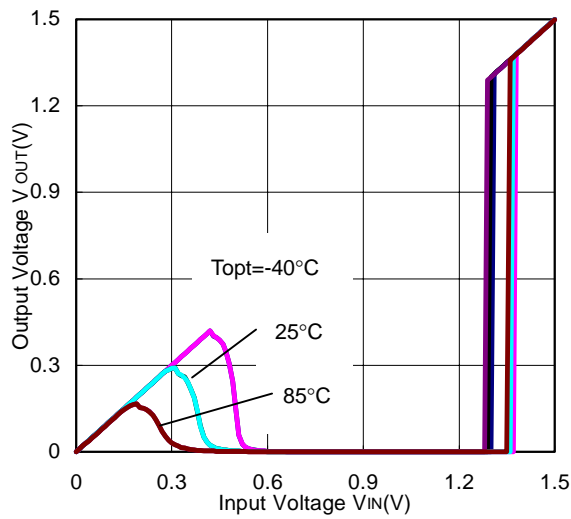

R3112X131A

5V pull up via 470kΩ

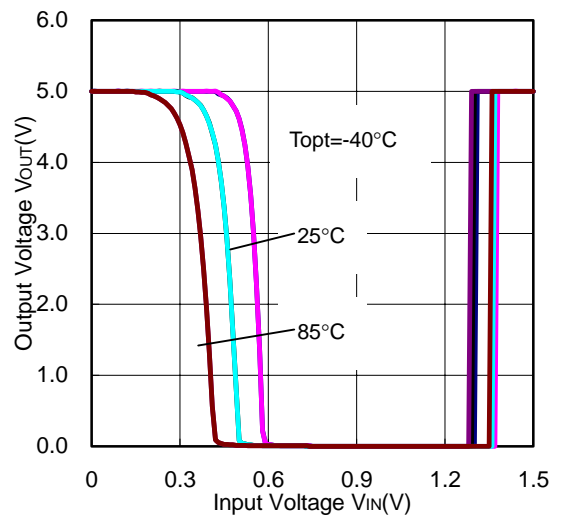

R3112X271X
Nch Output Type: VDD pull up

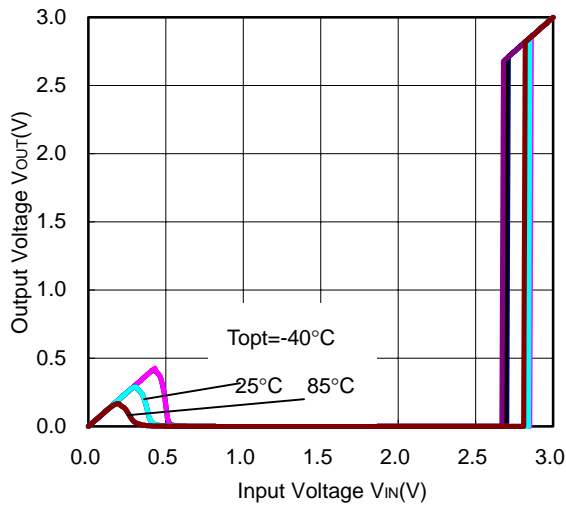

R3112X271A
5V pull up via 470kΩ

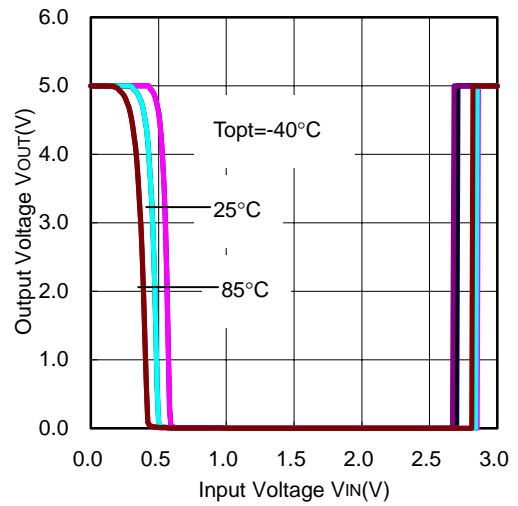

R3112X451X
Nch Output Type: VDD pull up

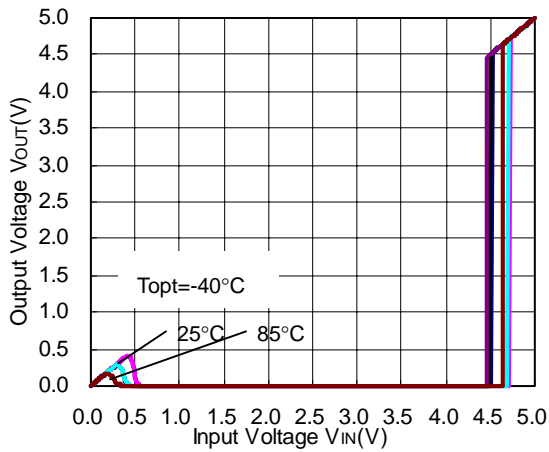

R3112X451A
5V pull up via 470kΩ

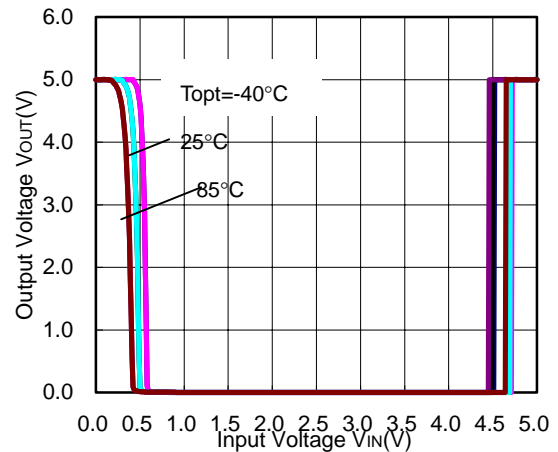

4) Nch Driver Output Current vs. VDS
R3112X091X

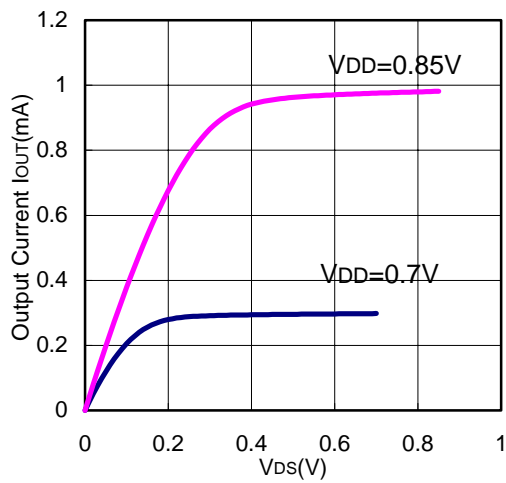

R3112X131X

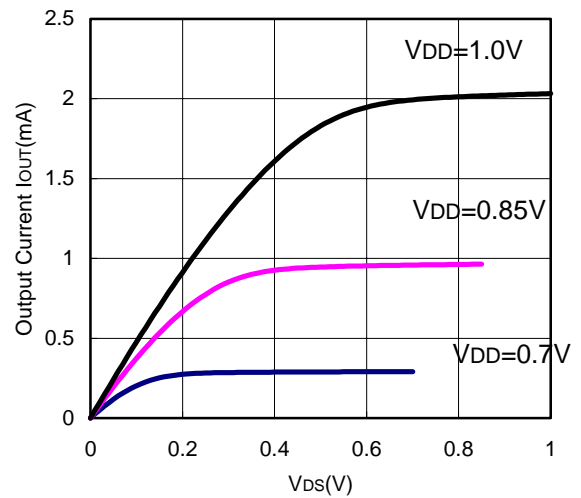

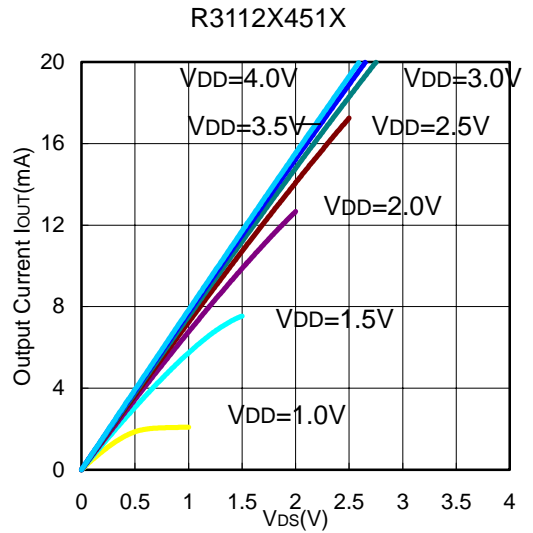
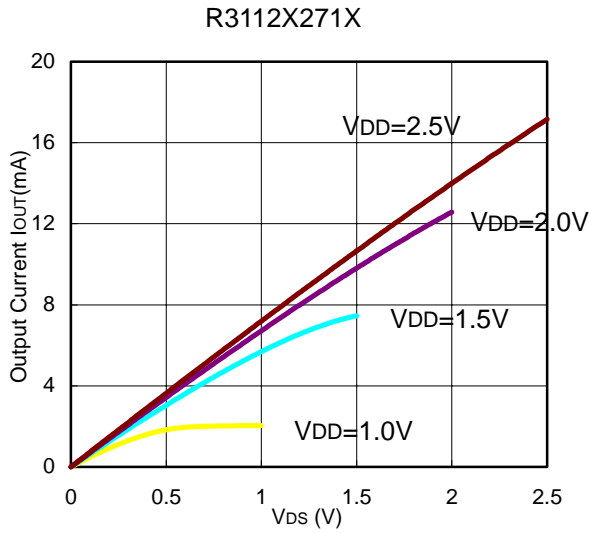

5) Nch Driver Output Current vs. Input Voltage
R3112X091X

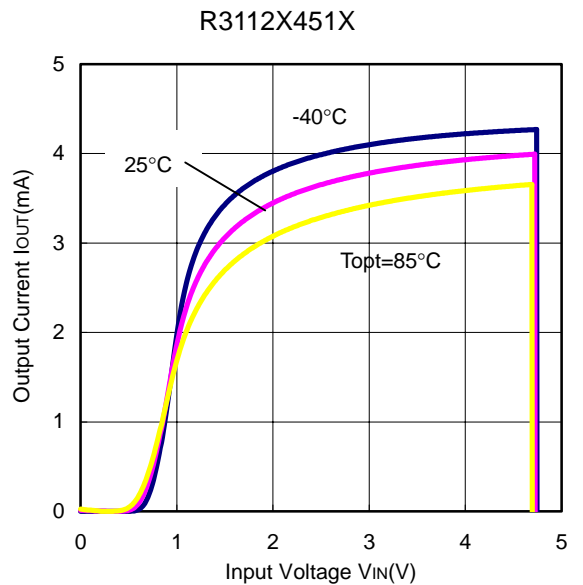
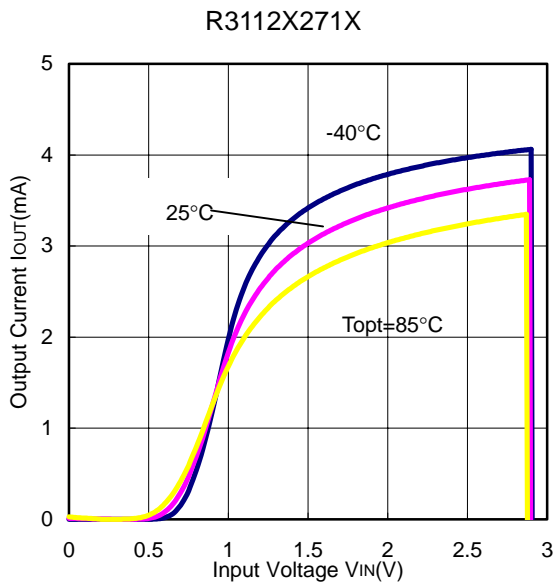
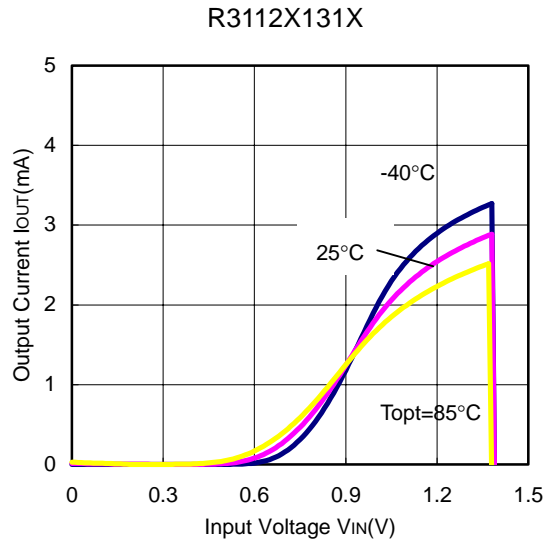
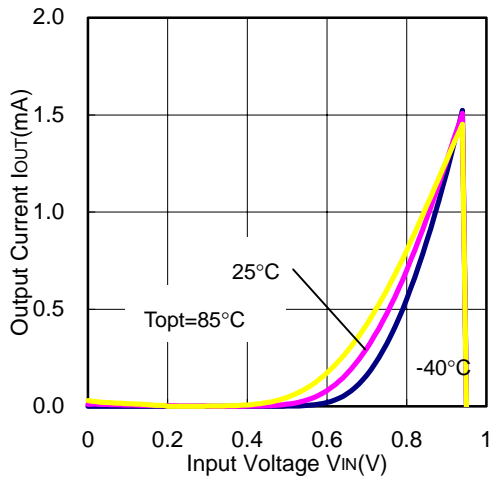

6) Pch Driver Output Current vs. Input Voltage
R3112X091C

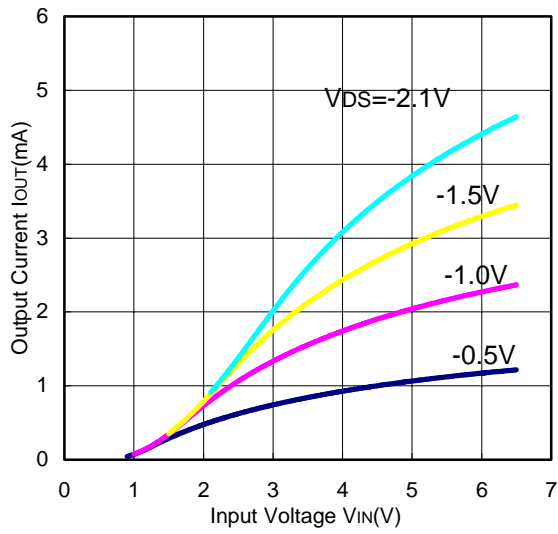

R3112X131C

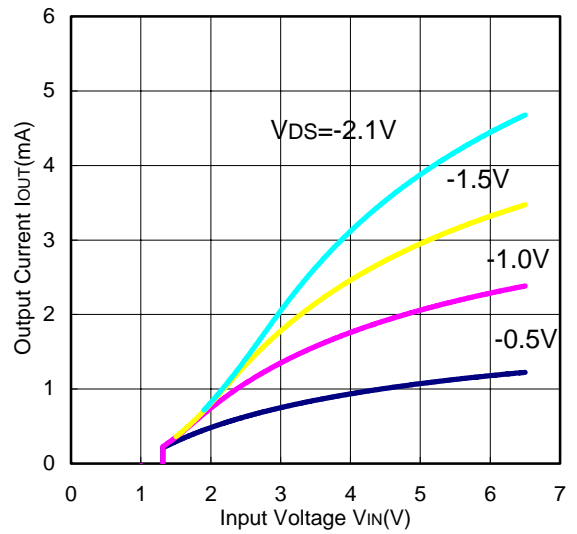

R3112X271C

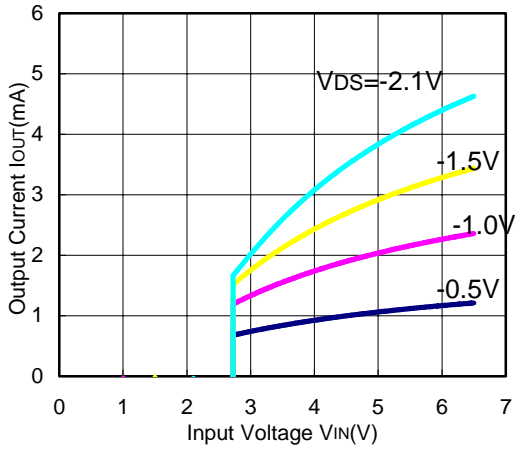

R3112X451C

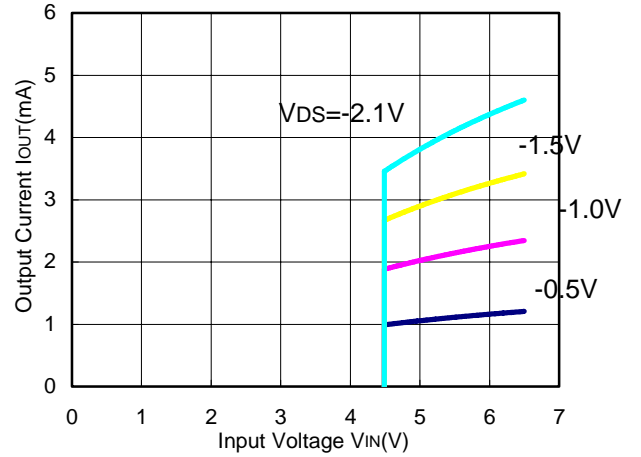

7) CD Pin Threshold Voltage vs. Temperature
R3112X091X $V_{DD} = 0.99V$

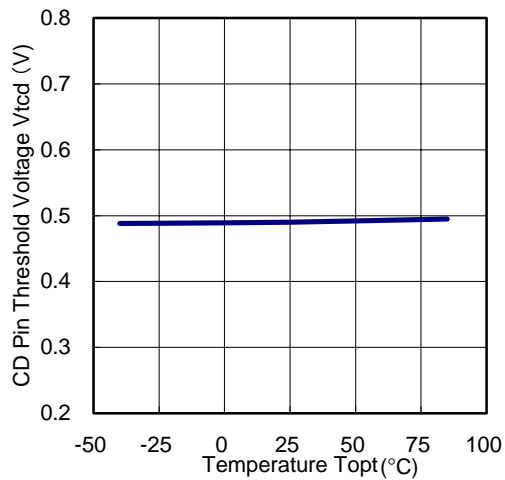

R3112X131X $V_{DD} = 1.43V$

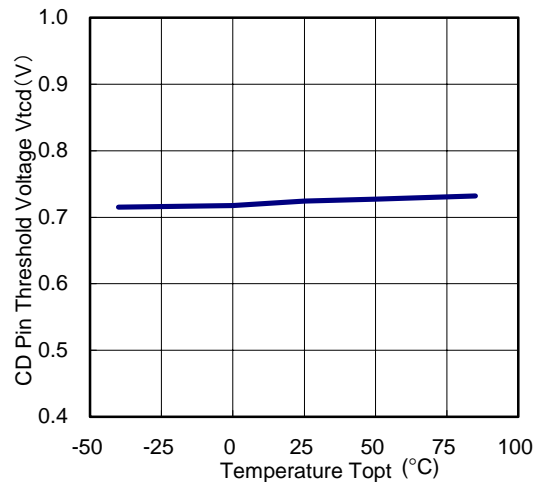

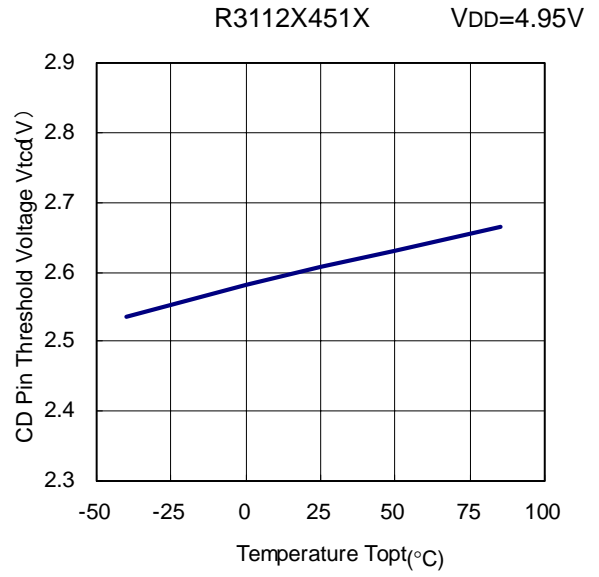
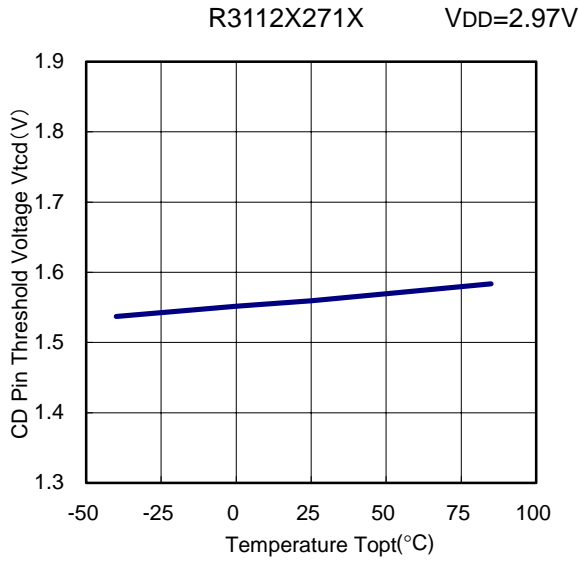

8) CD Pin Output Current vs. Input Voltage

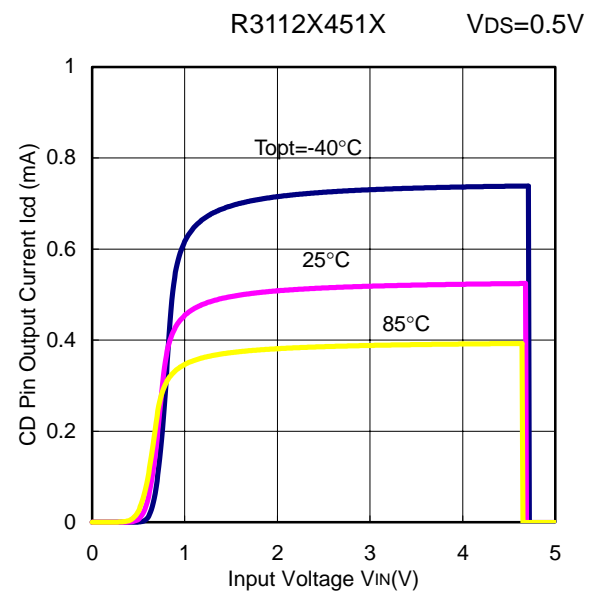
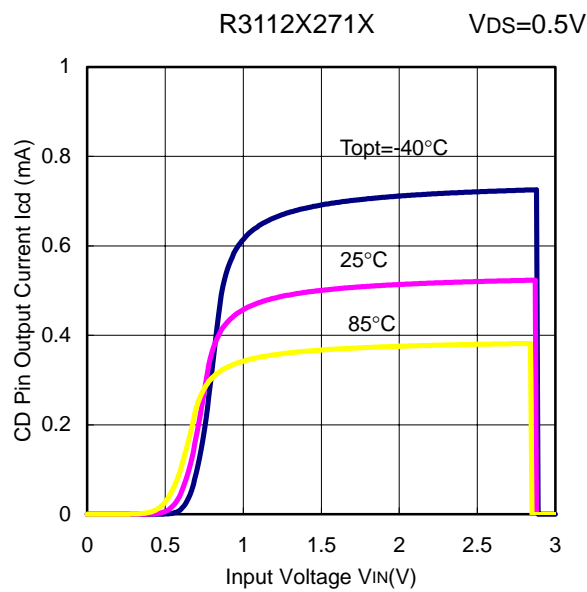
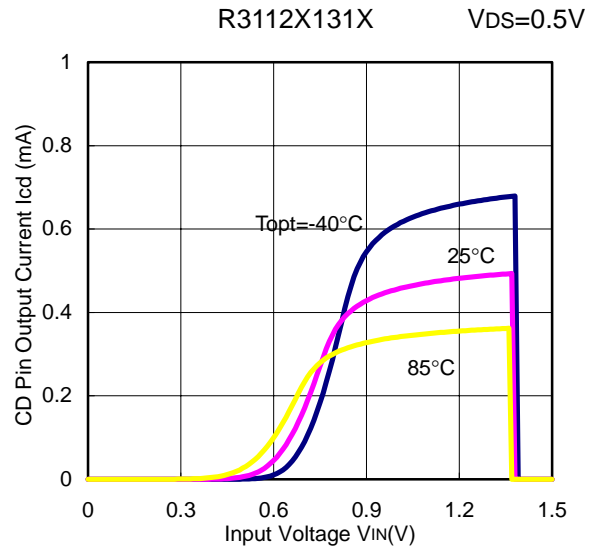
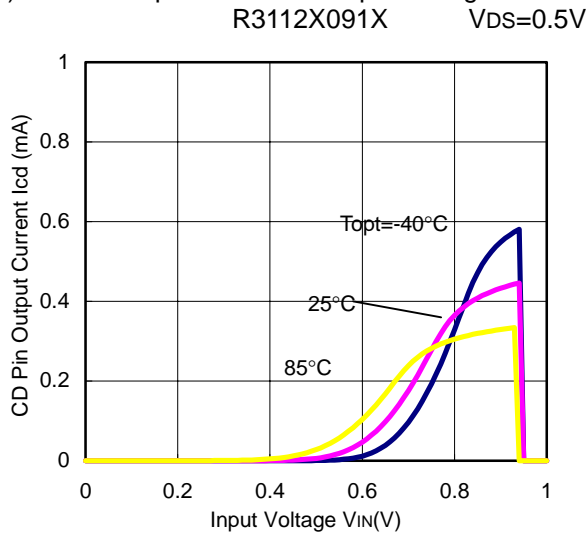

9) CD Pin Output Current vs. VDS (T_{opt}=25°C)
R3112X091X

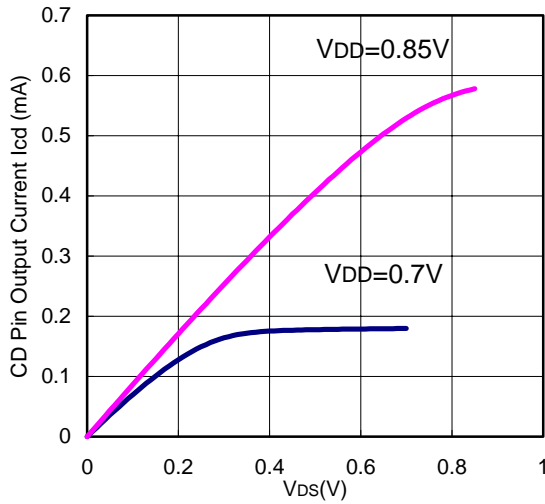

R3112X131X

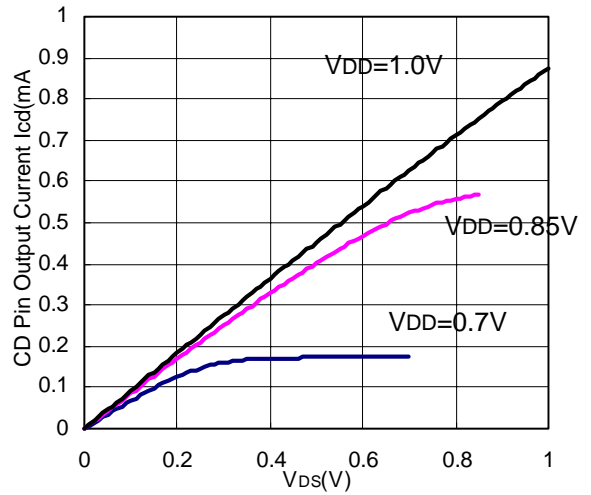

R3112X271X

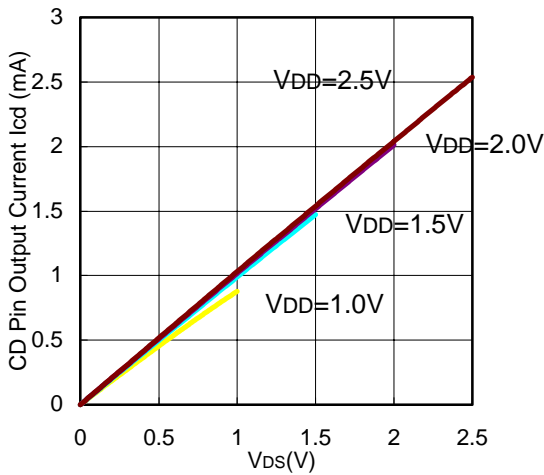

R3112X451X

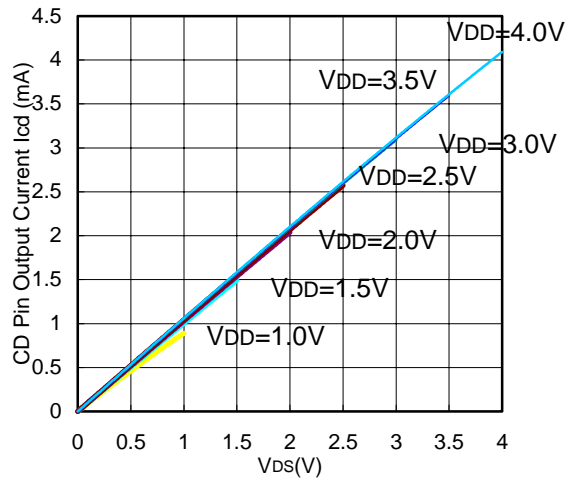

10) Output Delay Time vs. External Capacitance
R3112X091X

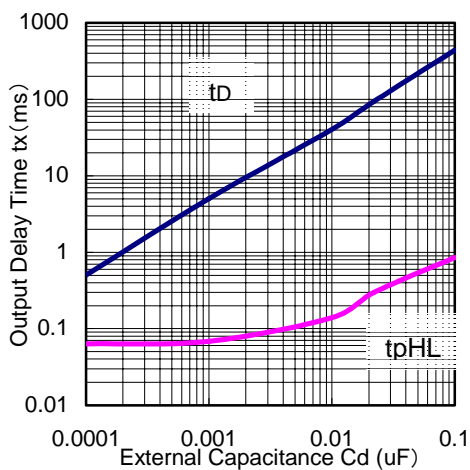

(T_{opt}=25°C)

R3112X131X

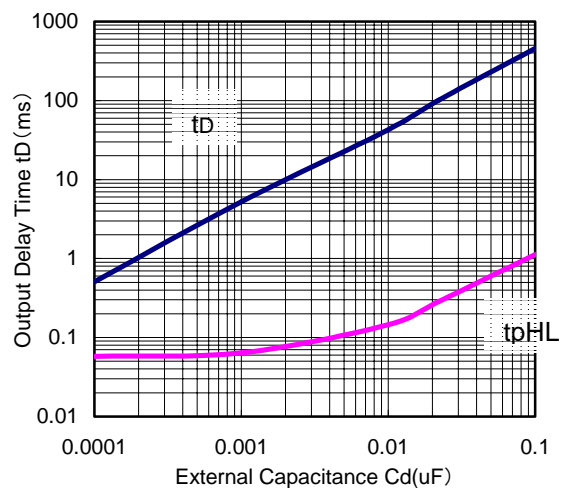

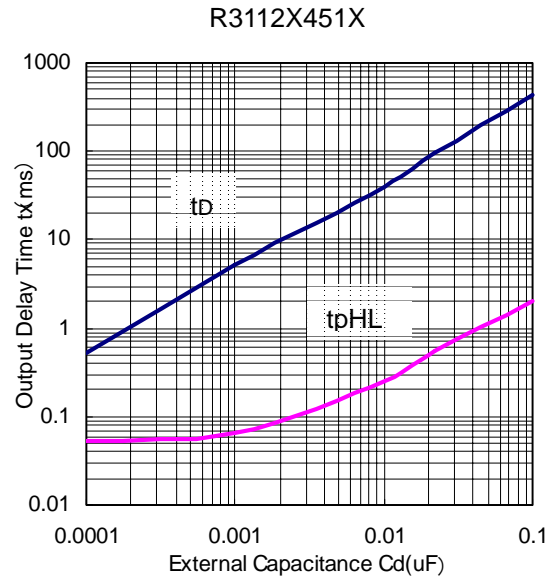
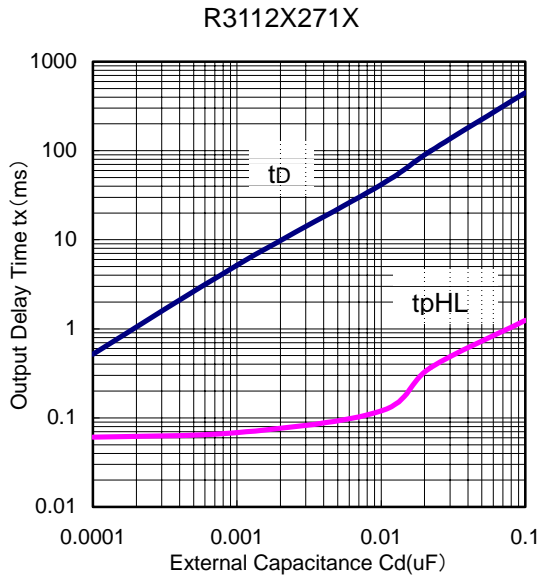

11) Delay Circuit Resistance vs. Temperature
R3112XXX1X

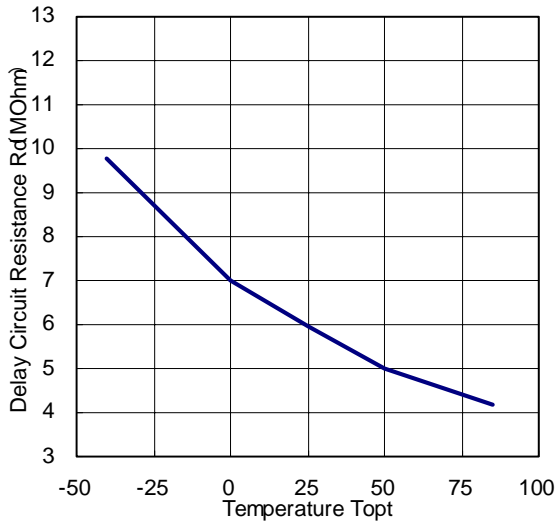

■ TECHNICAL NOTES

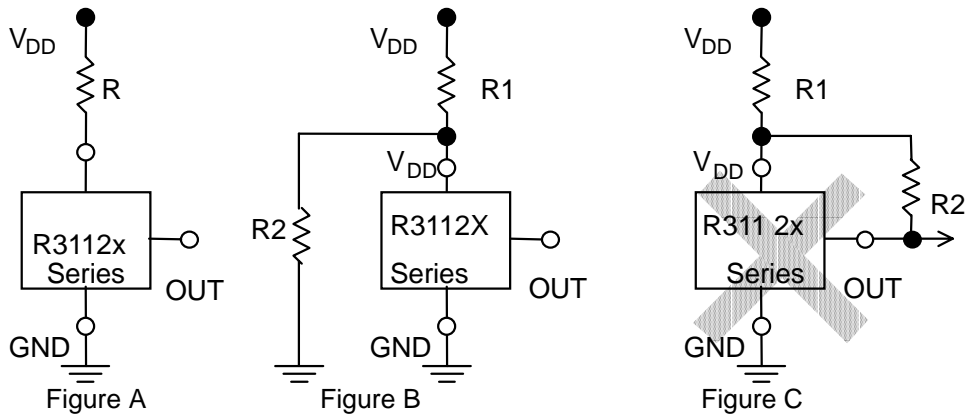

When R3112XXX1A (Nch Open Drain Output Type) is used in Figure A or Figure B, if Impedance of Voltage Supply pin, V_{DD} and V_{DD} of this IC is large, detector threshold level would shift by voltage dropdown caused by the consumption current of the IC itself. Released voltage may also shift and delay time for start-up might be generated by this usage.

When R3112XXX1C (CMOS Output Type) is used in Figure A or Figure B, Output level could be unstable by throughout current which is generated at detector threshold level or at released voltage level, therefore, do not use R3112XXX1C with the connection in Figure A or Figure B.

The connection in Figure C may cause the oscillation in both R3112XXX1C (CMOS Output) and R3112XXX1A (Nch Open Drain Output), therefore do not use R3112XXX1X Series with the connection in Figure C.

Компания «Океан Электроники» предлагает заключение долгосрочных отношений при поставках импортных электронных компонентов на взаимовыгодных условиях!

Наши преимущества:

- Поставка оригинальных импортных электронных компонентов напрямую с производств Америки, Европы и Азии, а так же с крупнейших складов мира;
- Широкая линейка поставок активных и пассивных импортных электронных компонентов (более 30 млн. наименований);
- Поставка сложных, дефицитных, либо снятых с производства позиций;
- Оперативные сроки поставки под заказ (от 5 рабочих дней);
- Экспресс доставка в любую точку России;
- Помощь Конструкторского Отдела и консультации квалифицированных инженеров;
- Техническая поддержка проекта, помощь в подборе аналогов, поставка прототипов;
- Поставка электронных компонентов под контролем ВП;
- Система менеджмента качества сертифицирована по Международному стандарту ISO 9001;
- При необходимости вся продукция военного и аэрокосмического назначения проходит испытания и сертификацию в лаборатории (по согласованию с заказчиком);
- Поставка специализированных компонентов военного и аэрокосмического уровня качества (Xilinx, Altera, Analog Devices, Intersil, Interpoint, Microsemi, Actel, Aeroflex, Peregrine, VPT, Syfer, Eurofarad, Texas Instruments, MS Kennedy, Miteq, Cobham, E2V, MA-COM, Hittite, Mini-Circuits, General Dynamics и др.);

Компания «Океан Электроники» является официальным дистрибьютором и эксклюзивным представителем в России одного из крупнейших производителей разъемов военного и аэрокосмического назначения «**JONHON**», а так же официальным дистрибьютором и эксклюзивным представителем в России производителя высокотехнологичных и надежных решений для передачи СВЧ сигналов «**FORSTAR**».



JONHON

«**JONHON**» (основан в 1970 г.)

Разъемы специального, военного и аэрокосмического назначения:

(Применяются в военной, авиационной, аэрокосмической, морской, железнодорожной, горно- и нефтедобывающей отраслях промышленности)

«**FORSTAR**» (основан в 1998 г.)

ВЧ соединители, коаксиальные кабели, кабельные сборки и микроволновые компоненты:

(Применяются в телекоммуникациях гражданского и специального назначения, в средствах связи, РЛС, а так же военной, авиационной и аэрокосмической отраслях промышленности).



Телефон: 8 (812) 309-75-97 (многоканальный)

Факс: 8 (812) 320-03-32

Электронная почта: ocean@oceanchips.ru

Web: <http://oceanchips.ru/>

Адрес: 198099, г. Санкт-Петербург, ул. Калинина, д. 2, корп. 4, лит. А