

Multilayer Band Pass Filters(Balance Output Type)

For 2.4GHz W-LAN/Bluetooth

DEA Series

Type: **DEA202450BT-7171A1 (2.0×1.25×0.6mm max.)**
 DEA202450BT-7190A1 (2.0×1.25×0.6mm max.)
 DEA202450BT-7099A1 (2.0×1.25×0.8mm max.)
 DEA202450BT-7100C1 (2.0×1.25×0.8mm max.)
 DEA202350BT-7196A1 (2.0×1.25×0.9mm)
 DEA202450BT-7077A1 (2.0×1.25×0.95mm)
 DEA202450BT-7089C3 (2.0×1.25×1.0mm max.)
 DEA202450BT-7112B1 (2.0×1.25×1.0mm max.)
 DEA202450BT-7112E1 (2.0×1.25×1.0mm max.)

Issue date: December 2010

- All specifications are subject to change without notice.
 - Conformity to RoHS Directive: This means that, in conformity with EU Directive 2002/95/EC, lead, cadmium, mercury, hexavalent chromium, and specific bromine-based flame retardants, PBB and PBDE, have not been used, except for exempted applications.
-

Multilayer Chip Band Pass Filters(Balance Output Type) Conformity to RoHS Directive For Bluetooth & 2.4GHz W-LAN

DEA Series DEA202450BT-7171A1

FEATURES

- Miniature balanced band pass filter.
- Matched to $34+j60\Omega$.
- Package size: $2.0 \times 1.25\text{mm}$.
- Low profile : 0.6mm max. height.

SHAPES AND DIMENSIONS

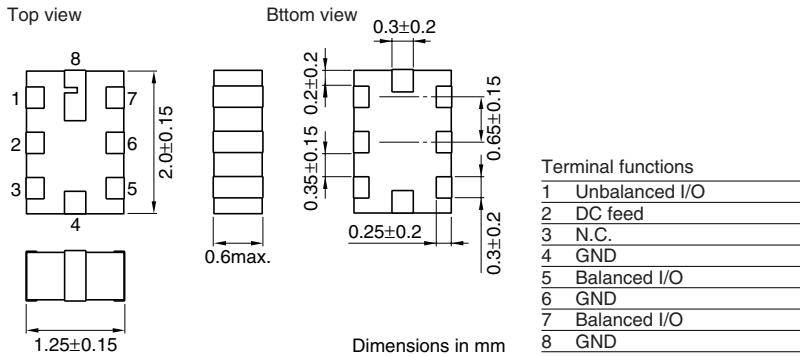

RECOMMENDED PC BOARD PATTERNS

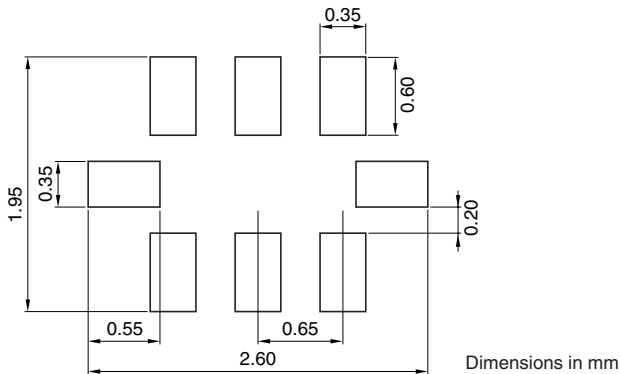

- Note 1: Pin 2 of the filter provides a DC feed connection to the balanced ports. In the event that this function is used, pin 2 should be connected to ground using a de-coupling capacitor.
- Note 2: In the event that the pin 2 function is not used, the pin should be left unconnected.

EVALUATION SETUP

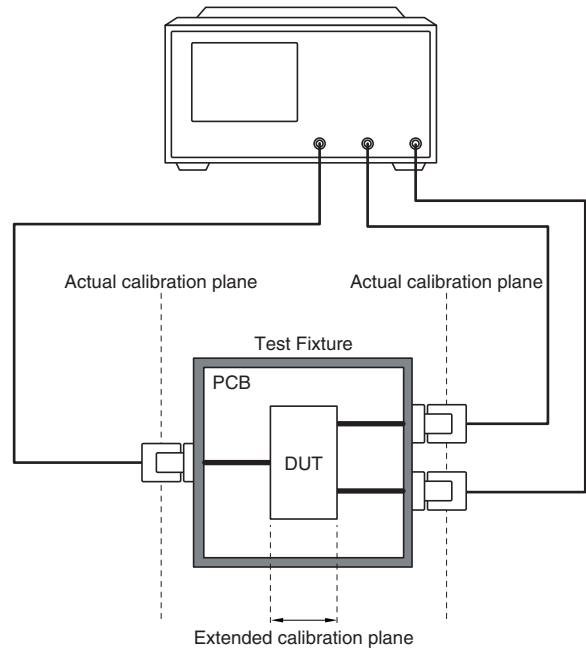

- Note 1: The Port Extension function on the Network Analyser is used to extend the calibration plane to the DUT terminals.
- Note 2: Loss in the PCB traces is compensated for by measurement data taken on a PCB Thru' line.

• Conformity to RoHS Directive: This means that, in conformity with EU Directive 2002/95/EC, lead, cadmium, mercury, hexavalent chromium, and specific bromine-based flame retardants, PBB and PBDE, have not been used, except for exempted applications.

• All specifications are subject to change without notice.

ELECTRICAL CHARACTERISTICS

Insertion Loss	[2402 to 2480MHz]	3.0dB max.
Single ended port characteristic impedance	—	50Ω (Nominal)
Balanced ports impedance, nominal value	—	34 + j60Ω
VSWR: Unbalanced port	[2402 to 2480MHz]	2max.
VSWR: Balanced port (with respect to nominal balanced impedance)	[2402 to 2480MHz]	2max.
Attenuation	[880 to 960MHz]	35dB min.
	[1710 to 1880MHz]	22dB min.
	[1880 to 1910MHz]	20dB min.
	[2110 to 2170MHz]	—
Phase difference at balanced port	[4804 to 4960MHz]	18dB min.
	[2402 to 2480MHz]	180±10.0°
Amplitude imbalance at balanced port	[2402 to 2480MHz]	0±2dB
Temperature range	Operating	-40 to +85°C
	Storage	-40 to +85°C

FREQUENCY CHARACTERISTICS

SDS21 INSERTION LOSS

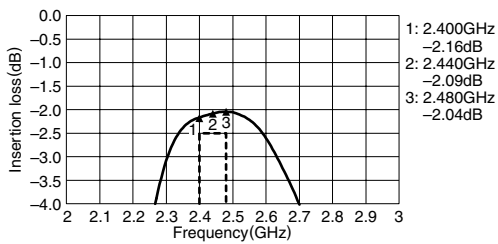

SDS21 ATTENUATION

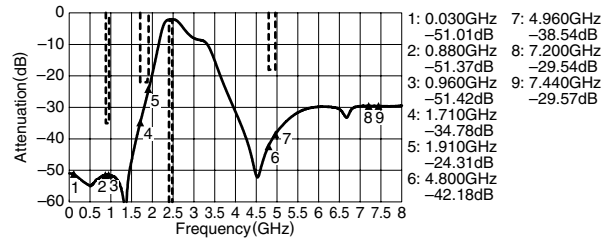

AMPLITUDE IMBALANCE

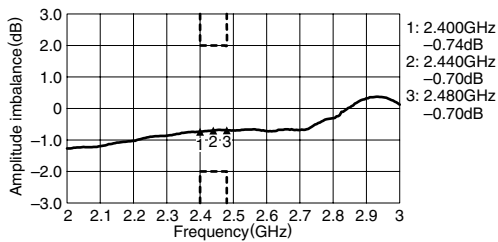

PHASE IMBALANCE

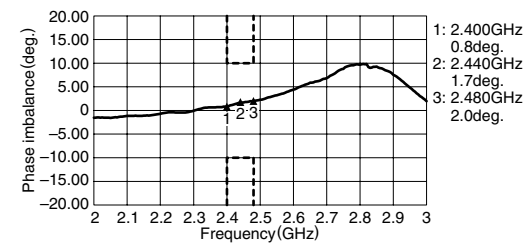

SSS11 VSWR

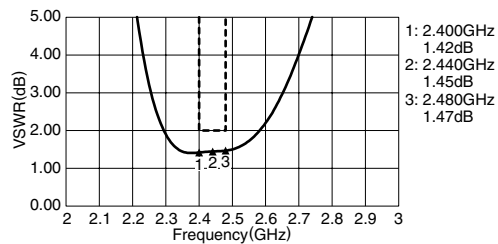

SDD22 VSWR

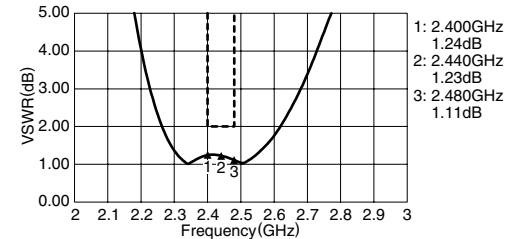

SMITH CHARTS

SSS11

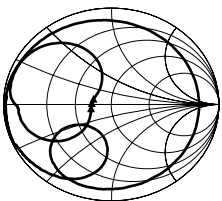

SDD22

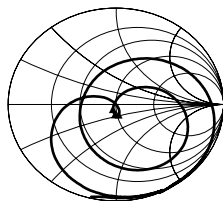

• All specifications are subject to change without notice.

PACKAGING STYLES
REEL DIMENSIONS

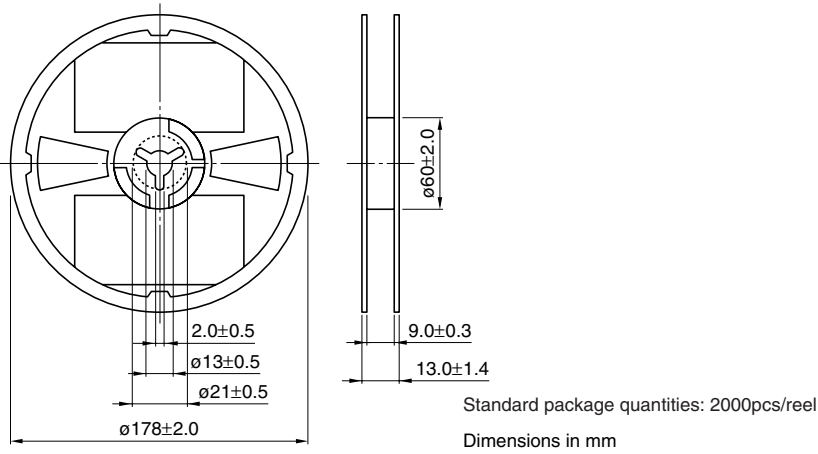

TAPE DIMENSIONS

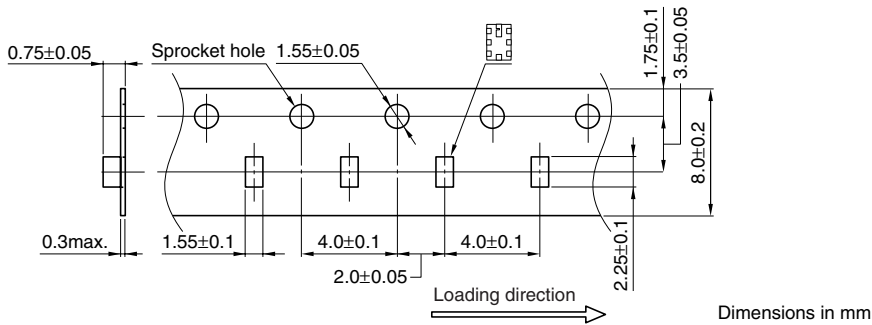

• All specifications are subject to change without notice.

Multilayer Chip Band Pass Filters(Balance Output Type) Conformity to RoHS Directive

For Bluetooth & 2.4GHz W-LAN

DEA Series DEA202450BT-7190A1

FEATURES

- Miniature balanced band pass filter.
- Matched to $34+j60\Omega$.
- Package size: $2.0 \times 1.25\text{mm}$.
- Low profile : 0.6mm max. height.

SHAPES AND DIMENSIONS

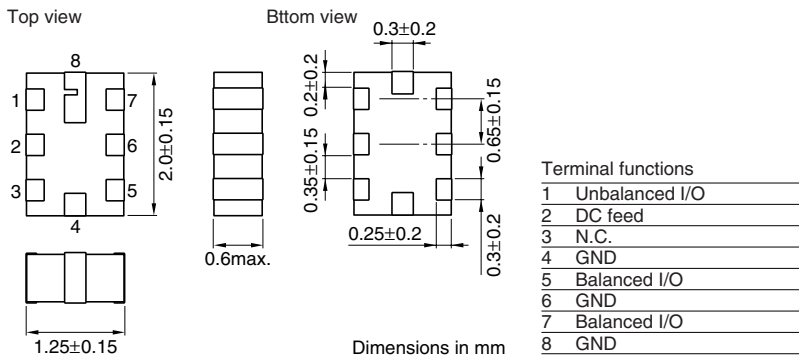

RECOMMENDED PC BOARD PATTERNS

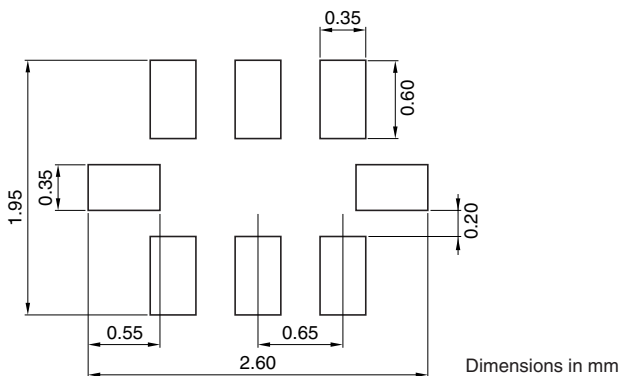

Note 1: Pin 2 of the filter provides a DC feed connection to the balanced ports.

In the event that this function is used, pin 2 should be connected to ground using a de-coupling capacitor.

Note 2: In the event that the pin 2 function is not used, the pin should be left unconnected.

EVALUATION SETUP

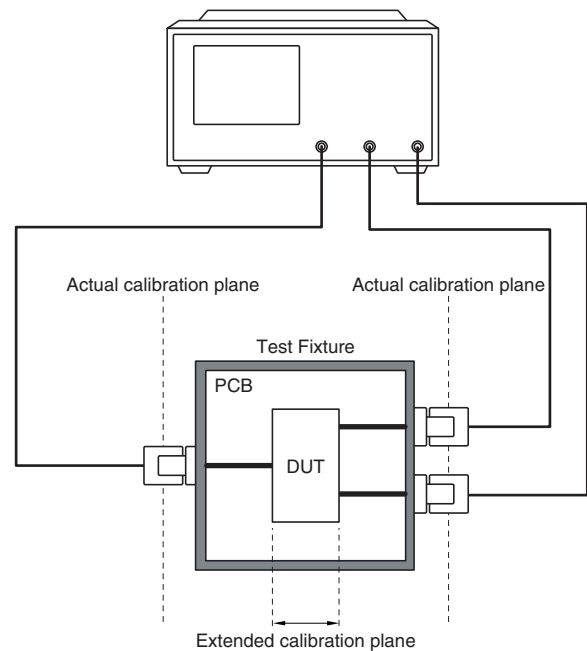

Note 1: The Port Extension function on the Network Analyser is used to extend the calibration plane to the DUT terminals.

Note 2: Loss in the PCB traces is compensated for by measurement data taken on a PCB Thru' line.

• Conformity to RoHS Directive: This means that, in conformity with EU Directive 2002/95/EC, lead, cadmium, mercury, hexavalent chromium, and specific bromine-based flame retardants, PBB and PBDE, have not been used, except for exempted applications.

• All specifications are subject to change without notice.

ELECTRICAL CHARACTERISTICS

Insertion Loss	[2402 to 2480MHz]	3.0dB max.
Single ended port characteristic impedance	—	50Ω (Nominal)
Balanced ports impedance, nominal value	—	34 + j60Ω
VSWR: Unbalanced port	[2402 to 2480MHz]	2max.
VSWR: Balanced port (with respect to nominal balanced impedance)	[2402 to 2480MHz]	2max.
Attenuation	[880 to 960MHz]	35dB min.
	[1710 to 1880MHz]	22dB min.
	[1880 to 1910MHz]	20dB min.
	[2110 to 2170MHz]	—
	[4804 to 4960MHz]	18dB min.
Phase difference at balanced port	[2402 to 2480MHz]	180±10.0°
Amplitude imbalance at balanced port	[2402 to 2480MHz]	0±2dB
Temperature range	Operating	-40 to +85°C
	Storage	-40 to +85°C

FREQUENCY CHARACTERISTICS

SDS21 INSERTION LOSS

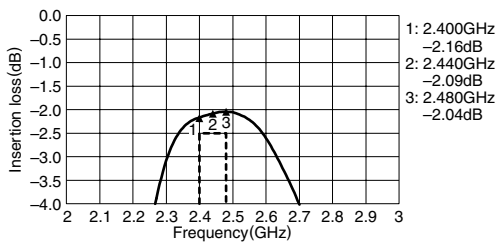

SDS21 ATTENUATION

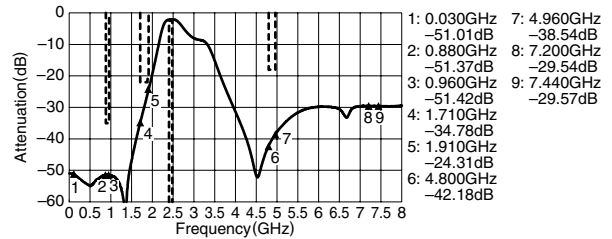

AMPLITUDE IMBALANCE

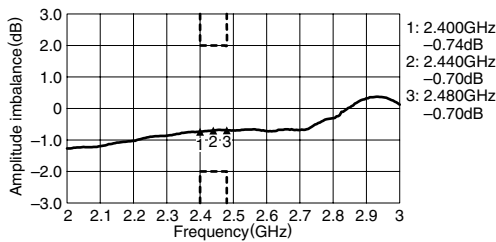

PHASE IMBALANCE

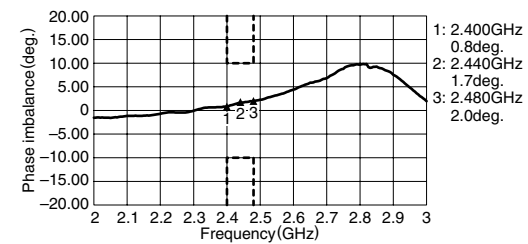

SSS11 VSWR

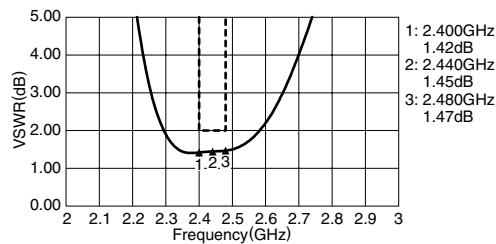

SDD22 VSWR

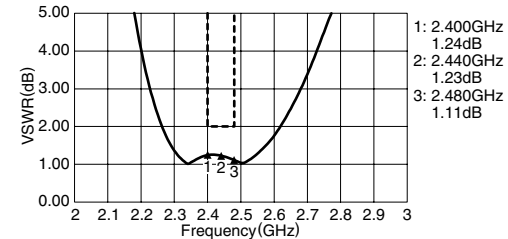

SMITH CHARTS

SSS11

SDD22

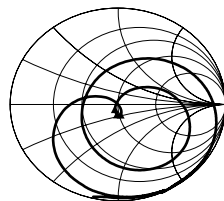
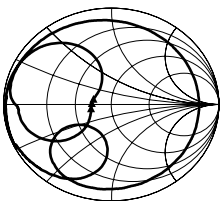

• All specifications are subject to change without notice.

PACKAGING STYLES
REEL DIMENSIONS

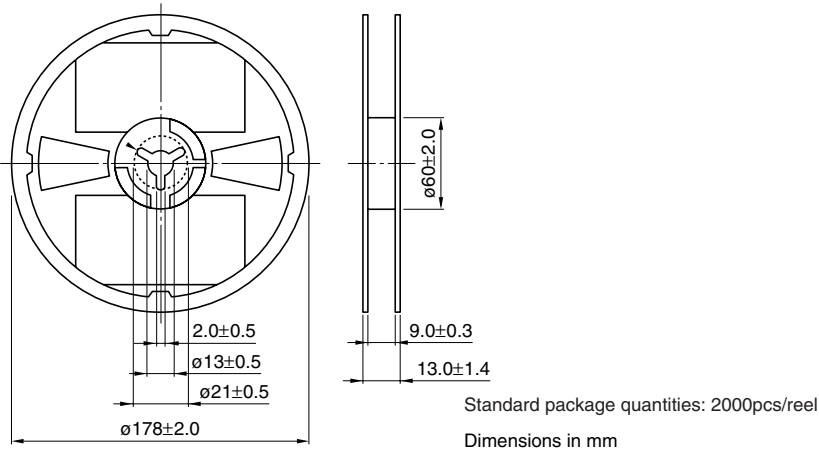

TAPE DIMENSIONS

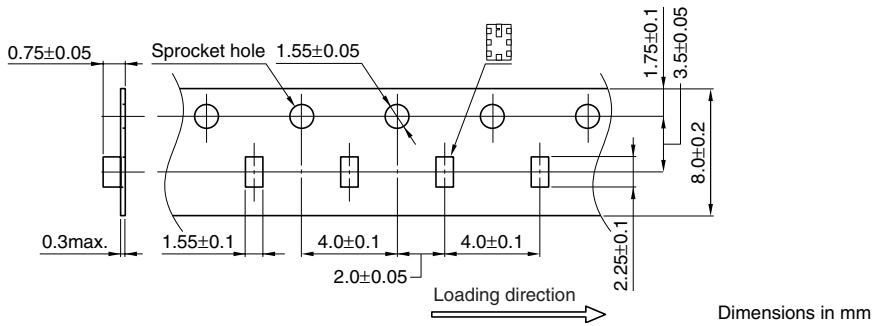

• All specifications are subject to change without notice.

Multilayer Chip Band Pass Filters(Balance Output Type) Conformity to RoHS Directive

For Bluetooth & 2.4GHz W-LAN

DEA Series DEA202450BT-7099A1

FEATURES

- Miniature balanced band pass filter.
- Matched to $24+j48.8\Omega$.
- Package size: $2.0 \times 1.25\text{mm}$.
- Low profile : 0.8mm max. height.

SHAPES AND DIMENSIONS

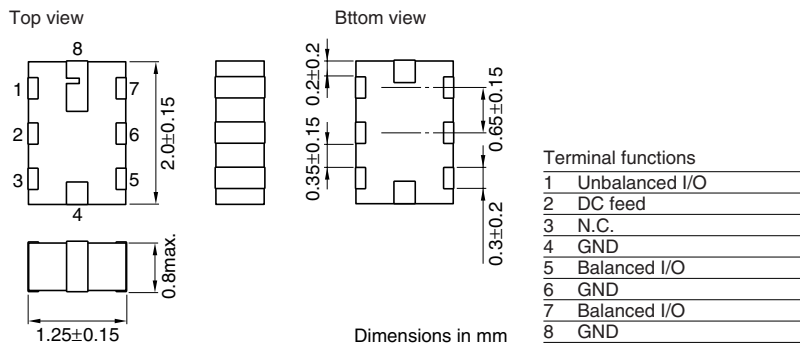

The identification marking in figure refer to prototype components only.
A different component mark is used for mass production.

RECOMMENDED PC BOARD PATTERNS

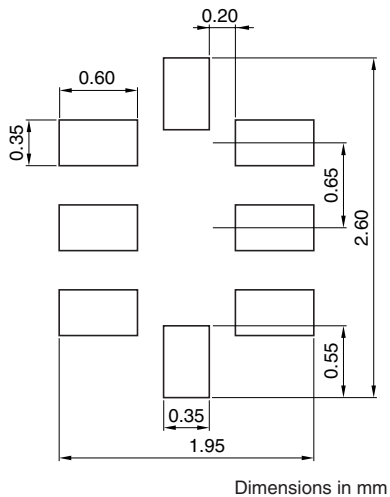

- Pin 2 of the filter provides a DC feed connection to the balanced ports.
- In the event that this function is used pin 2 should be connected to ground using a de-coupling capacitor.

- Conformity to RoHS Directive: This means that, in conformity with EU Directive 2002/95/EC, lead, cadmium, mercury, hexavalent chromium, and specific bromine-based flame retardants, PBB and PBDE, have not been used, except for exempted applications.

- All specifications are subject to change without notice.

ELECTRICAL CHARACTERISTICS

Insertion Loss	[2402 to 2480MHz]	2.3dB typ.
Single ended port characteristic impedance	—	50Ω (Nominal)
Balanced ports impedance, nominal value	—	24 + j48.8Ω
Return loss: Unbalanced port	[2402 to 2480MHz]	11.9dB typ.
Return loss: Balanced port (with respect to nominal balanced impedance)		11dB typ.
Attenuation	[880 to 960MHz]	47dB typ.
	[1710 to 1880MHz]	29dB typ.
	[1880 to 1910MHz]	27dB typ.
	[2110 to 2170MHz]	10dB typ.
	[4804 to 4960MHz]	36dB typ.
Phase difference at balanced port	[2402 to 2480MHz]	176deg typ.
Amplitude imbalance at balanced port	[2402 to 2480MHz]	0.9dB typ.
Temperature range	Operating	-40 to +85°C
	Storage	-40 to +85°C

FREQUENCY CHARACTERISTICS

INSERTION LOSS/ATTENUATION

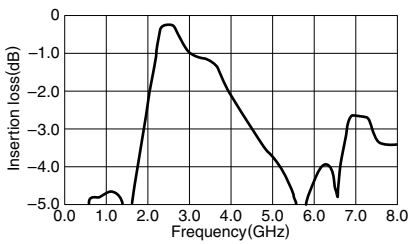

RETURN LOSS(Unbalance)

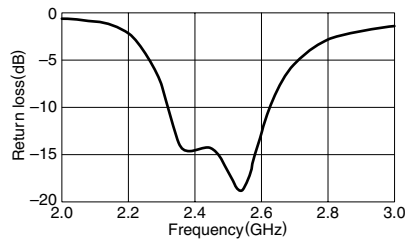

RETURN LOSS(Balance)

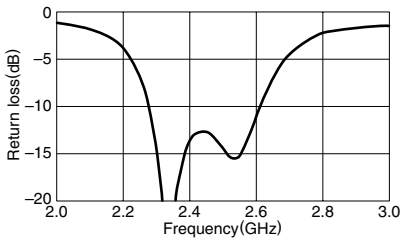

AMPLITUDE IMBALANCE

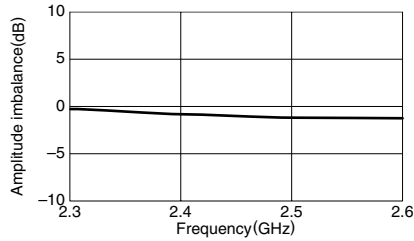

PHASE DIFFERENCE

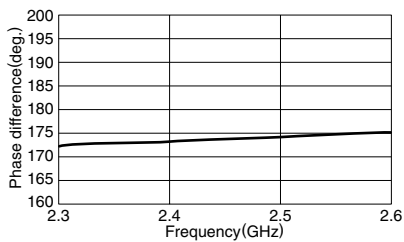

COMMON MODE

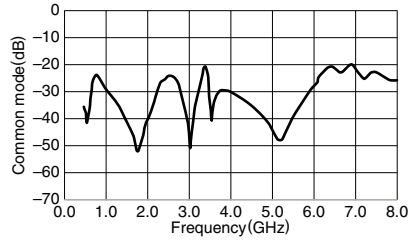

• All specifications are subject to change without notice.

Multilayer Chip Band Pass Filters(Balance Output Type) Conformity to RoHS Directive For Bluetooth & 2.4GHz W-LAN

DEA Series DEA202450BT-7100C1

SHAPES AND DIMENSIONS

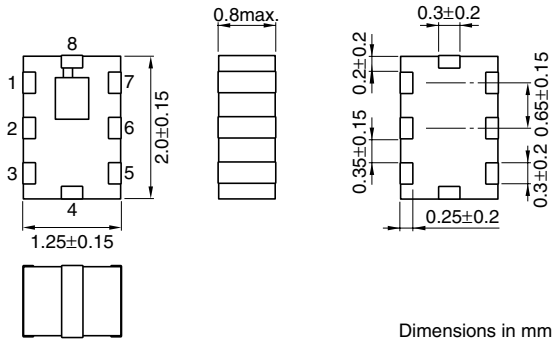

Terminal functions

1	Unbalanced port
2	GND
3	NC
4	GND
5	GND
6	Balanced port1
7	Balanced port2
8	GND

RECOMMENDED PC BOARD PATTERN

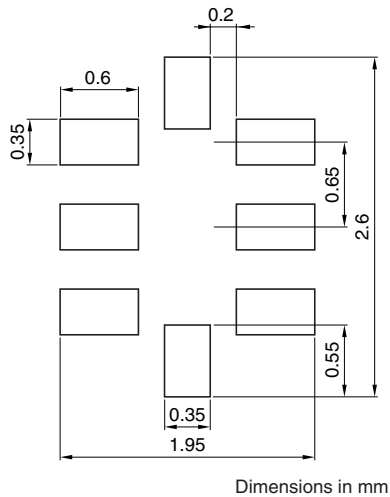

EVALUATION BOARD

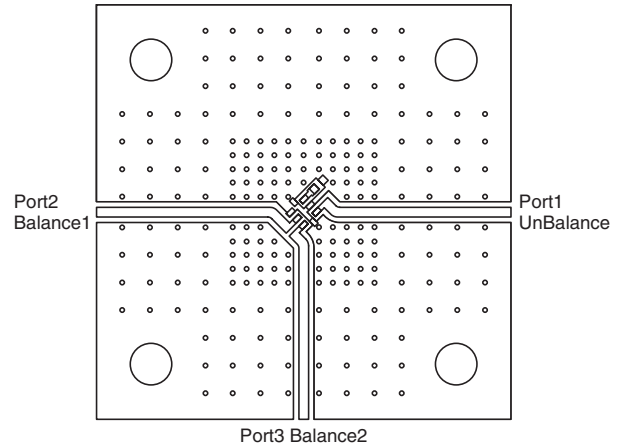

Port extension value
 Port1 = 139.56p[sec]
 Port2 = 143.16p[sec]
 Port3 = 139.56p[sec]

- Conformity to RoHS Directive: This means that, in conformity with EU Directive 2002/95/EC, lead, cadmium, mercury, hexavalent chromium, and specific bromine-based flame retardants, PBB and PBDE, have not been used, except for exempted applications.

- All specifications are subject to change without notice.

ELECTRICAL CHARACTERISTICS

Item		Minimum value	Typical value	Maximum value
Unbalanced port characteristics impedance	(Ω)	50[Nominal]		
Balanced port characteristics impedance	(Ω)	25+j30[Nominal]		
Differential mode insertion loss	[2402 to 2480MHz]	(dB)	—	3.5
	[65 to 108MHz]	(dB)	35	70
	[824 to 960MHz]	(dB)	35	46
Differential mode attenuation [100 Ω reference]	[1570 to 1580MHz]	(dB)	30	43
	[1710 to 1990MHz]	(dB)	35	44
	[2010 to 2170MHz]	(dB)	23	31
	[7200 to 7500MHz]	(dB)	20	40
Common mode attenuation [25 Ω reference]	[1570 to 1580MHz]	(dB)	30	34
	[1710 to 1990MHz]	(dB)	20	36
	[2010 to 2170MHz]	(dB)	20	33
	[4800 to 5000MHz]	(dB)	18	25
In/out return loss	(dB)	9	13	—
Phase difference at balanced port	(deg.)	180 \pm 10	174	—
Amplitude imbalance at balanced port	(dB)	0 \pm 2.8	1.7	—
Temperature range	Operating	($^{\circ}$ C)	—	+85
	Storage	($^{\circ}$ C)	-40	+85

• Ta:+25 $^{\circ}$ C

FREQUENCY CHARACTERISTICS

Unbalance 50 Ω /Balance 25+j30 Ω

SDS21 INSERTION LOSS

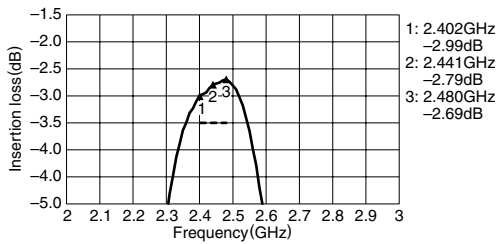

SDS21 ATTENUATION[100 Ω REFERENCE]

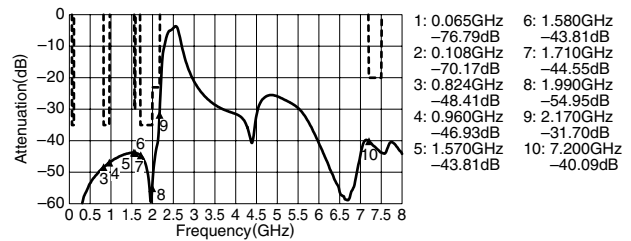

AMPLITUDE BALANCE

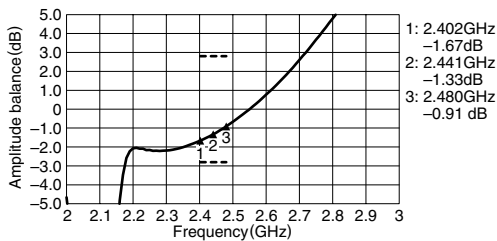

PHASE BALANCE

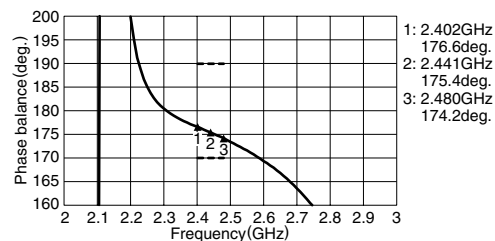

SSS11 UNBALANCE RETURN LOSS

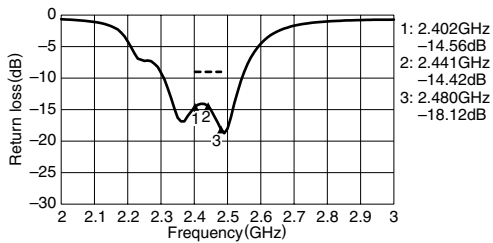

SDD22 BALANCE RETURN LOSS

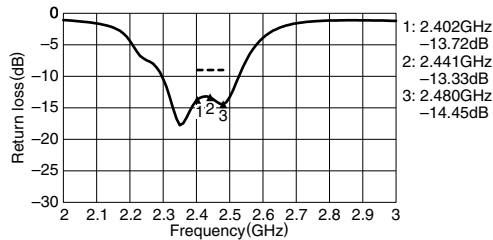

• All specifications are subject to change without notice.

FREQUENCY CHARACTERISTICS

Unbalance 50Ω/Balance 25+j30Ω

SCS21 ATTENUATION[25Ω REFERENCE]

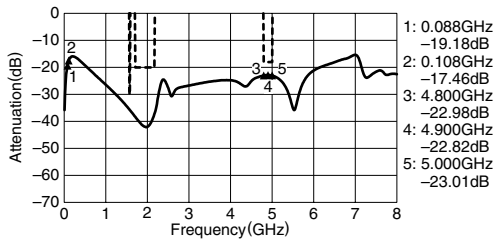

SCC22 ANGLE[25Ω REFERENCE]

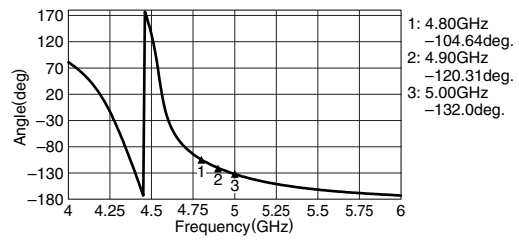

SCC22 MAGNITUDE[25Ω REFERENCE]

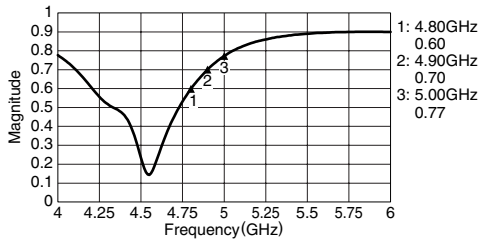

SMITH CHARTS

S11

SDD22

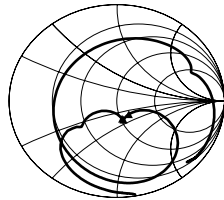
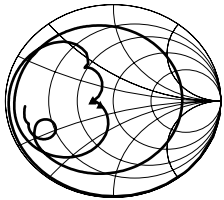

Multilayer Chip Band Pass Filters(Balance Output Type) For Bluetooth & 2.4GHz W-LAN

Conformity to RoHS Directive

DEA Series DEA202350BT-7196A1

SHAPES AND DIMENSIONS

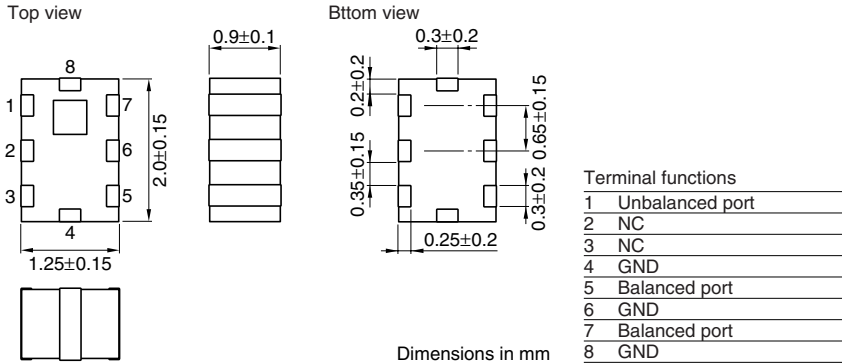

RECOMMENDED PC BOARD PATTERNS

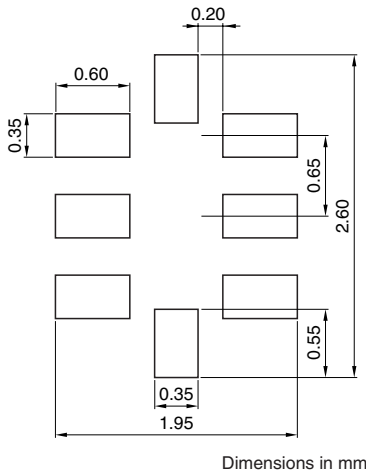

EVALUATION BOARD

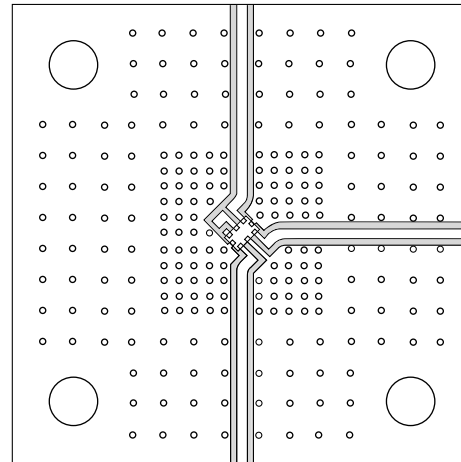

Port extension value is 139.56ps for all port.

ELECTRICAL CHARACTERISTICS

Item	Typical value	
Frequency range(Pass band)	2300 to 2400MHz	
Insertion loss	[+25°C]	2.2dB max. 1.76dB
	[-40 to +85°C]	2.5dB max. —
Single ended port characteristic impedance	50Ω (Nominal) —	
Balanced port differential characteristics impedance	100dB —	
Attenuation	[500 to 1000MHz]	34dB min. 44.3dB
	[1000 to 1785MHz]	26dB min. 31.6dB
	[1785 to 1880MHz]	25dB min. 34.9dB
	[1880 to 1980MHz]	15dB min. 22.6dB
	[2720 to 5900MHz]	10dB min. 13.2dB
Single ended return loss	[2300 to 2400MHz]	— 17dB
Phase difference at balanced port	[2300 to 2400MHz]	— 185.1deg.
Amplitude imbalance at balanced port	[2300 to 2400MHz]	— 0.13dB
Temperature range	Operating	-40 to +85°C
	Storage	-40 to +85°C

• Ta:+25°C

• Conformity to RoHS Directive: This means that, in conformity with EU Directive 2002/95/EC, lead, cadmium, mercury, hexavalent chromium, and specific bromine-based flame retardants, PBB and PBDE, have not been used, except for exempted applications.

• All specifications are subject to change without notice.

FREQUENCY CHARACTERISTICS

Unbalance 50Ω/Balance 100Ω

SDS21 INSERTION LOSS

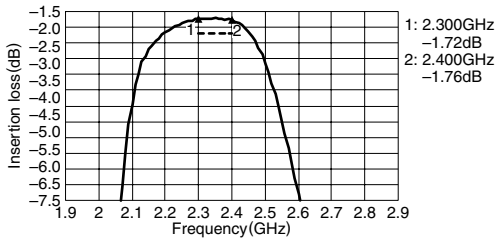

SDS21 ATTENUATION

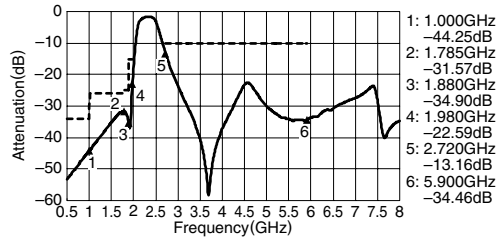

AMPLITUDE BALANCE

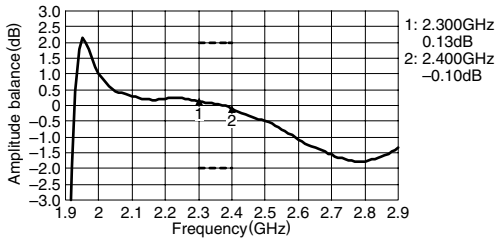

PHASE BALANCE

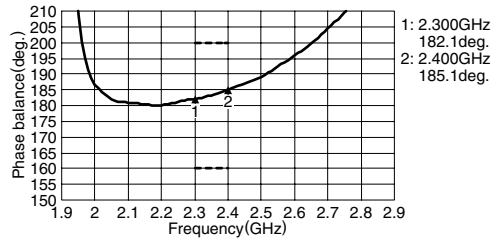

S11 UNBALANCE RETURN LOSS

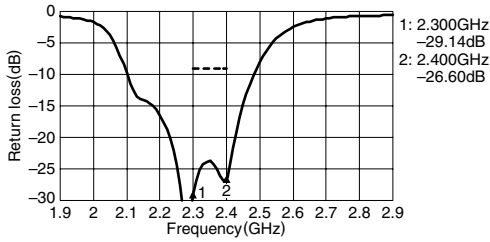

SDD22 BALANCE RETURN LOSS

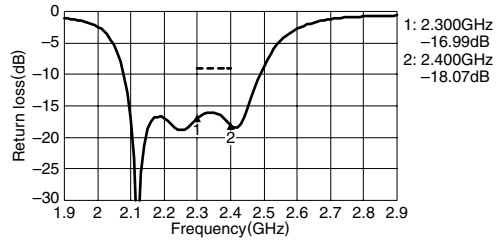

SCS21

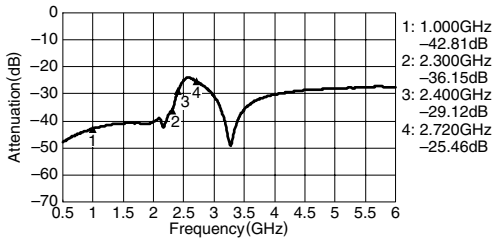

SMITH CHARTS

S11

SDD22

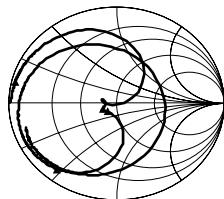
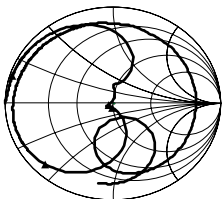

Multilayer Chip Band Pass Filters(Balance Output Type) Conformity to RoHS Directive

For Bluetooth & 2.4GHz W-LAN

DEA Series DEA202450BT-7077A1

SHAPES AND DIMENSIONS

Top view

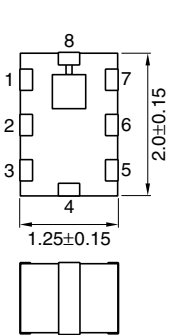

Bottom view

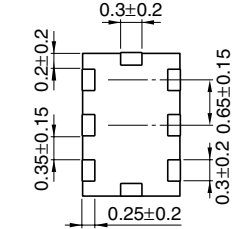

Dimensions in mm

Terminal functions

1	Unbalanced port
2	DC feed + RF GND or GND
3	NC
4	GND
5	Balanced port
6	GND
7	Balanced port
8	GND

RECOMMENDED PC BOARD PATTERN

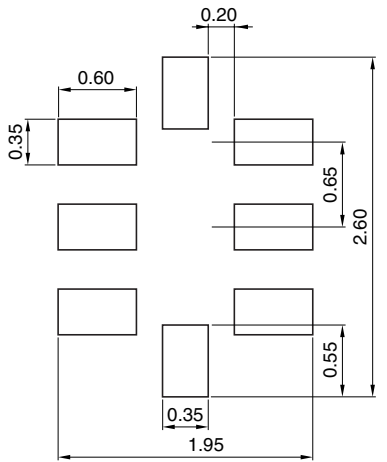

Dimensions in mm

- Conformity to RoHS Directive: This means that, in conformity with EU Directive 2002/95/EC, lead, cadmium, mercury, hexavalent chromium, and specific bromine-based flame retardants, PBB and PBDE, have not been used, except for exempted applications.

- All specifications are subject to change without notice.

ELECTRICAL CHARACTERISTICS

Frequency range(Pass band)		2400MHz	2500MHz
Insertion loss	[+25°C]	—	3.5dB max.
	[-40 to +85°C]	—	3.8dB max.
Single ended port characteristic impedance		50Ω (Nominal)	—
Balanced port differential characteristics impedance		34+j72Ω(Nominal)	—
Attenuation	[880 to 960MHz]	40dB	—
	[1710 to 1880MHz]	38dB	—
	[1880 to 1990MHz]	38dB	—
	[2110 to 2170MHz]	17dB	—
	[4800 to 5000MHz]	25dB	—
	[7200 to 7500MHz]	27dB	—
Single ended return loss	[2400 to 2500MHz]	9.0dB	—
Balanced return loss	[2400 to 2500MHz]	9.0dB	—
Phase difference at balanced port		170deg.	190deg.
Amplitude imbalance at balanced port		-1.0dB	1.0dB
Temperature range	Operating	-40 to +85°C	
	Storage	-40 to +85°C	

• Ta:+25°C

FREQUENCY CHARACTERISTICS

Unbalance 50Ω/Balance 34+j72Ω

SDS21 INSERTION LOSS

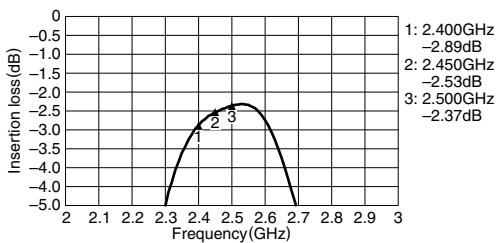

SDS21 ATTENUATION

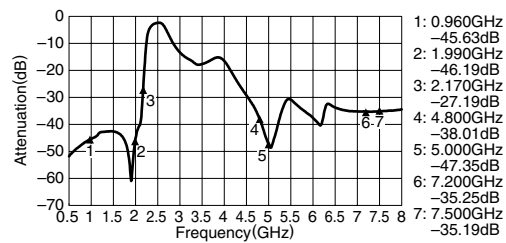

S11 UNBALANCE RETURN LOSS

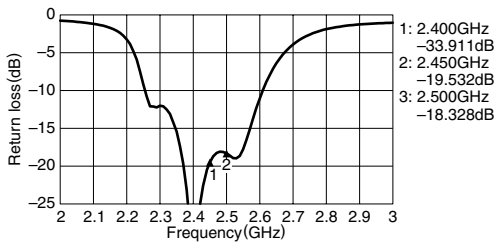

SDD22 BALANCE RETURN LOSS

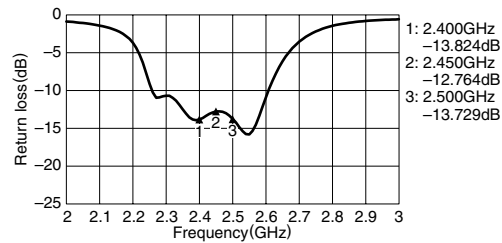

AMPLITUDE BALANCE

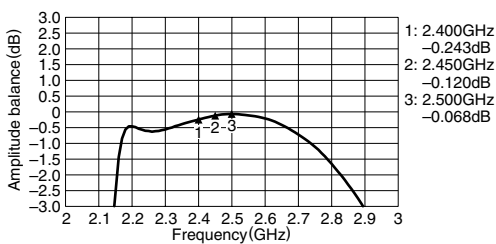

PHASE BALANCE

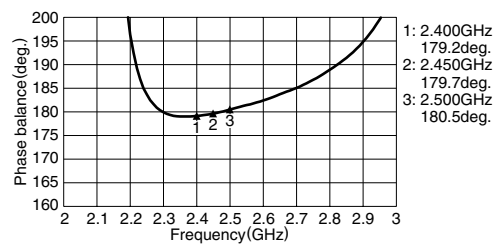

SCS21 CMRR

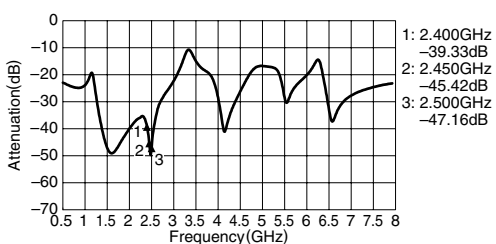

• All specifications are subject to change without notice.

SMITH CHARTS

S11

SDD22

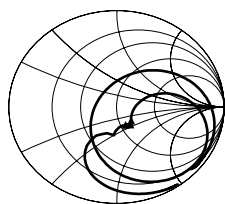
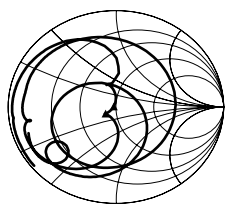

Multilayer Chip Band Pass Filters(Balance Output Type) Conformity to RoHS Directive

For Bluetooth & 2.4GHz W-LAN

DEA Series DEA202450BT-7089C3

SHAPES AND DIMENSIONS

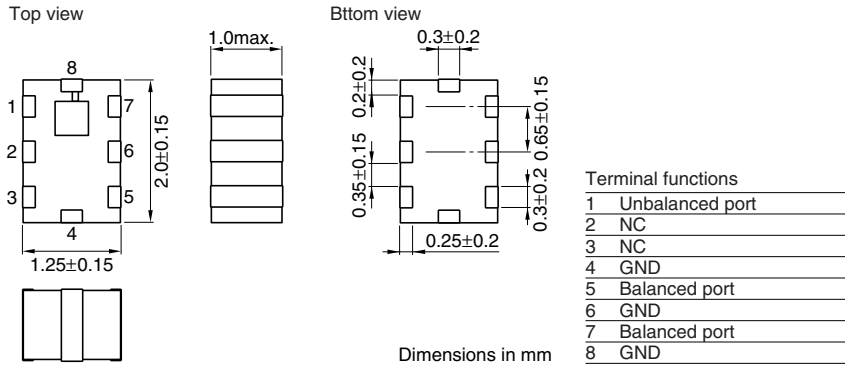

RECOMMENDED PC BOARD PATTERNS

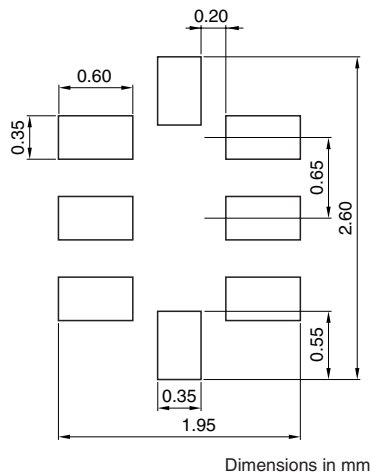

ELECTRICAL CHARACTERISTICS

Item	Typical value		
Frequency range(Pass band)	2400 to 2500MHz		
Insertion loss	[+25°C]	3.4dB max.	
	[-40 to +85°C]	3.7dB max.	
Single ended port characteristic impedance	50Ω (Nominal)		
Balanced port differential characteristics impedance	55+j50Ω (Nominal)		
Attenuation	[10 to 915MHz]	40dB min.	46dB
	[925 to 960MHz]	39dB min.	45dB
	[1570 to 1580MHz]	30dB min.	44dB
	[1710 to 1785MHz]	39dB min.	47dB
	[1805 to 1880MHz]	25dB min.	55dB
	[1850 to 1910MHz]	38dB min.	51dB
	[1920 to 1990MHz]	33dB min.	48dB
	[2112 to 2168MHz]	20dB min.	31dB
	[4800 to 5000MHz]	26dB min.	38dB
Single ended return loss	[2400 to 2500MHz]	8.5dB min.	13dB
	[2400 to 2500MHz]	8.5dB min.	14dB
Phase difference at balanced port	[2400 to 2500MHz]	180±10deg.	183deg.
Amplitude imbalance at balanced port	[2400 to 2500MHz]	0±2.0dB	-0.5dB
Temperature range	Operating	-40 to +85°C	
	Storage	-40 to +85°C	

• Ta:+25°C

• Conformity to RoHS Directive: This means that, in conformity with EU Directive 2002/95/EC, lead, cadmium, mercury, hexavalent chromium, and specific bromine-based flame retardants, PBB and PBDE, have not been used, except for exempted applications.

• All specifications are subject to change without notice.

FREQUENCY CHARACTERISTICS

Unbalance 50Ω/Balance 55+j50Ω

SDS21 INSERTION LOSS

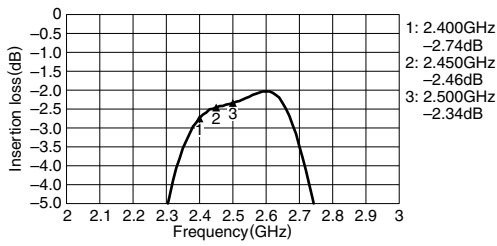

SDS21 ATTENUATION

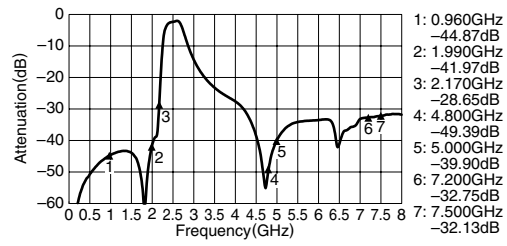

S11 UNBALANCE RETURN LOSS

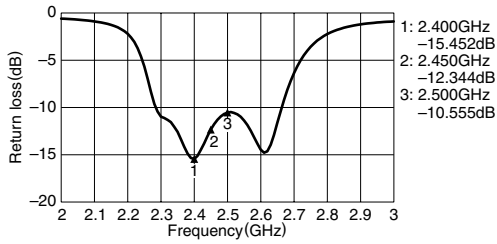

SDD22 BALANCE RETURN LOSS

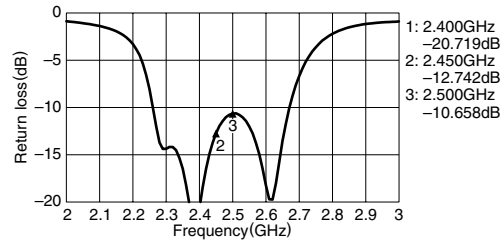

AMPLITUDE BALANCE

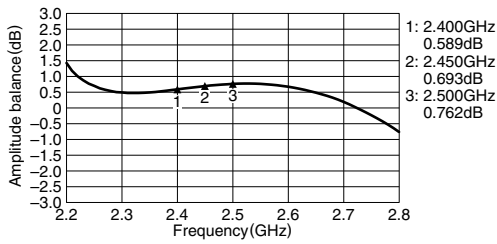

PHASE BALANCE

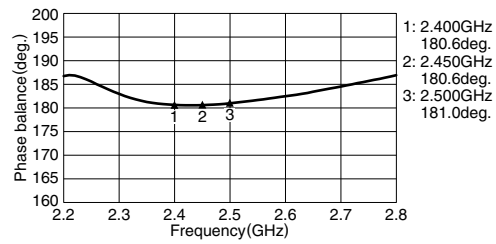

SCS21 CMRR

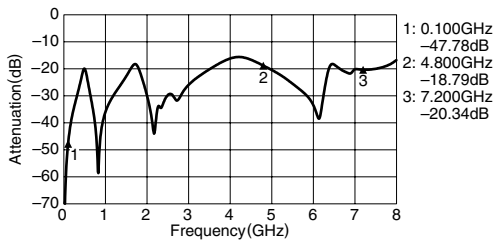

SMITH CHARTS

S11

SDD22

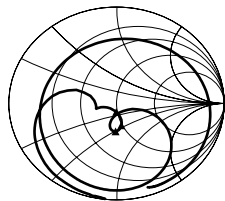
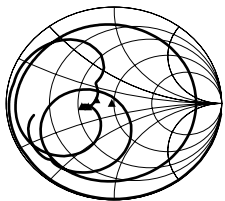

Multilayer Chip Band Pass Filters(Balance Output Type) Conformity to RoHS Directive For Bluetooth & 2.4GHz W-LAN

DEA Series DEA202450BT-7112B1

SHAPES AND DIMENSIONS

Top view

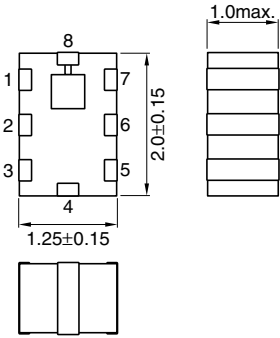

Bttom view

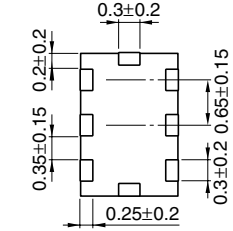

Dimensions in mm

Terminal functions

1	Unbalanced port
2	NC
3	NC
4	GND
5	Balanced port
6	GND
7	Balanced port
8	GND

RECOMMENDED PC BOARD PATTERN

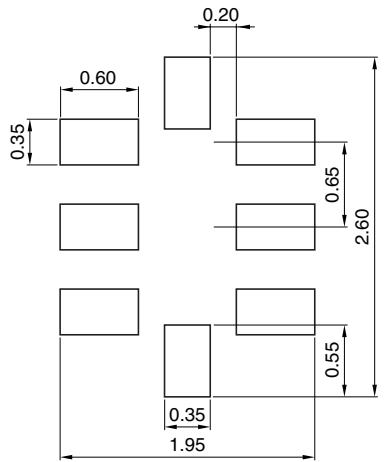

Dimensions in mm

EVALUATION BOARD

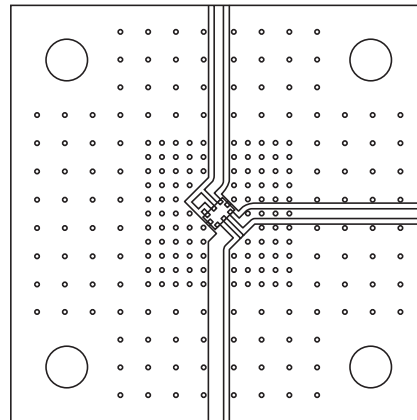

Port extension value is 139.56ps for all port.

• Conformity to RoHS Directive: This means that, in conformity with EU Directive 2002/95/EC, lead, cadmium, mercury, hexavalent chromium, and specific bromine-based flame retardants, PBB and PBDE, have not been used, except for exempted applications.

• All specifications are subject to change without notice.

ELECTRICAL CHARACTERISTICS

Frequency range(Pass band)		2400MHz	2500MHz
Insertion loss	[+25°C]	—	2.5dB max.
	[-40 to +85°C]	—	2.8dB max.
Single ended port characteristic impedance		50Ω (Nominal)	—
Balanced port differential characteristics impedance		50+j40Ω (Nominal)	—
Attenuation	[10 to 915MHz]	41dB	—
	[925 to 960MHz]	34dB	—
	[1570 to 1580MHz]	30dB	—
	[1710 to 1785MHz]	40dB	—
	[1805 to 1880MHz]	26dB	—
	[1850 to 1910MHz]	40dB	—
	[1920 to 1990MHz]	31dB	—
Single ended return loss	[2400 to 2500MHz]	9dB	—
	[2400 to 2500MHz]	9dB	—
Phase difference at balanced port	[2400 to 2500MHz]	170deg.	190deg.
Amplitude imbalance at balanced port	[2400 to 2500MHz]	-2dB	2dB
Common mode attenuation	[88 to 108MHz]	15dB	—
	[4800 to 5000MHz]	18dB	—
Common mode impedance [4900MHz]	Magnitude	0.6	—
	Angle	-45deg.	12deg.
Temperature range	Operating	-40 to +85°C	—
	Storage	-40 to +85°C	—

• Ta:+25°C

FREQUENCY CHARACTERISTICS

Unbalance 50Ω/Balance 50+j40Ω

SDS21 INSERTION LOSS

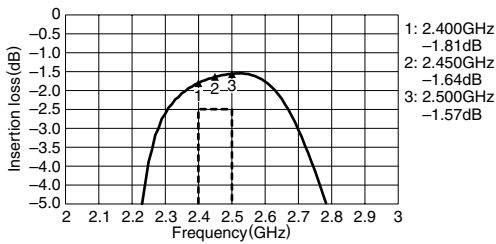

SDS21 ATTENUATION

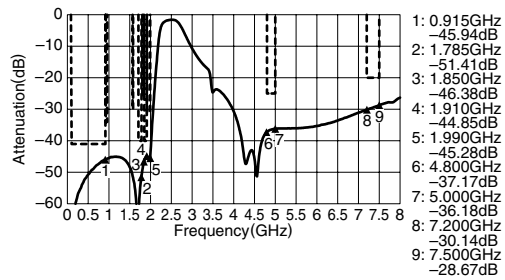

AMPLITUDE BALANCE

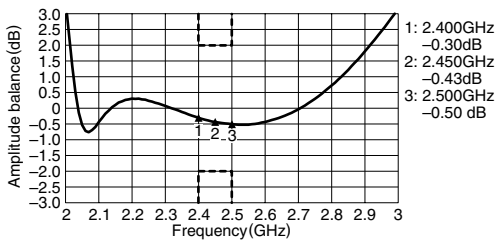

PHASE BALANCE

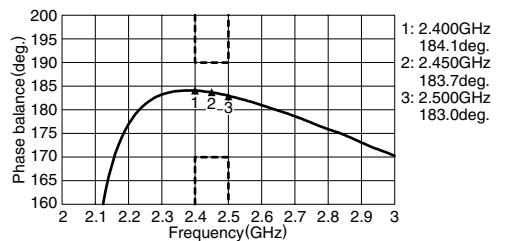

S11 UNBALANCE RETURN LOSS

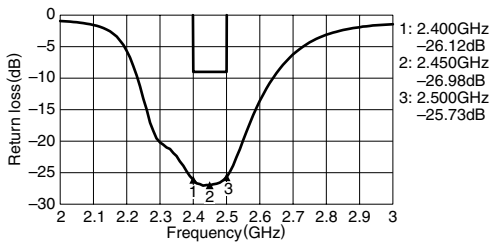

SDD22 BALANCE RETURN LOSS

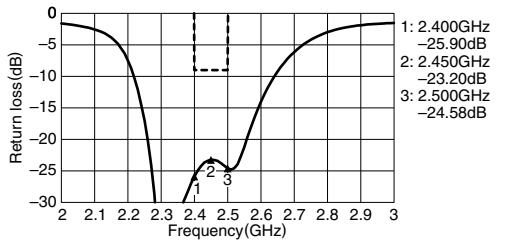

• All specifications are subject to change without notice.

FREQUENCY CHARACTERISTICS

Unbalance 50Ω/Balance 50+j40Ω

SCS21

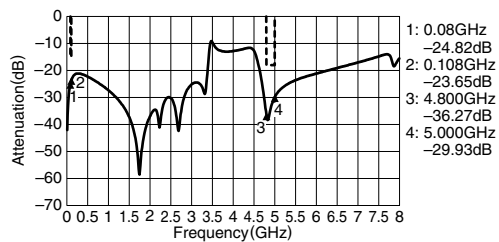

SCC22 MAGNITUDE

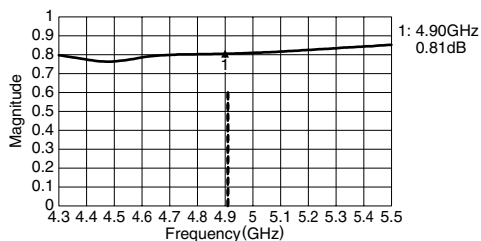

SCC22 ANGLE

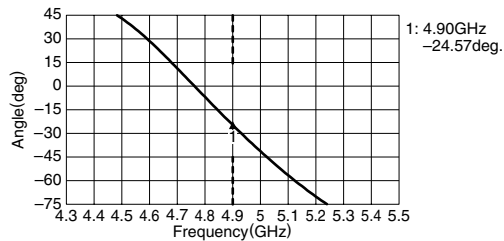

• All specifications are subject to change without notice.

Multilayer Chip Band Pass Filters(Balance Output Type) Conformity to RoHS Directive For Bluetooth & 2.4GHz W-LAN

DEA Series DEA202450BT-7112E1

SHAPES AND DIMENSIONS

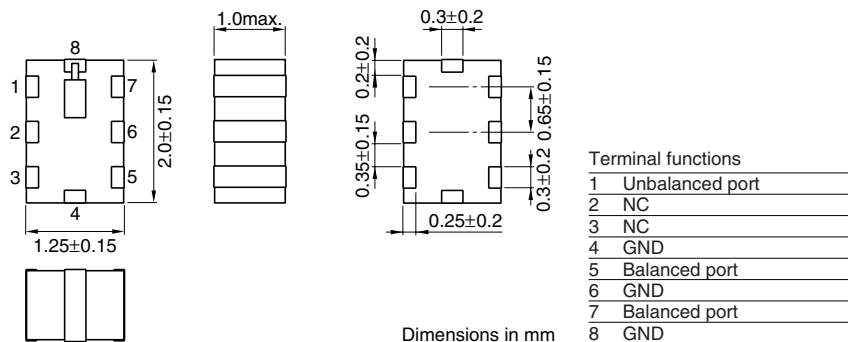

RECOMMENDED PC BOARD PATTERN

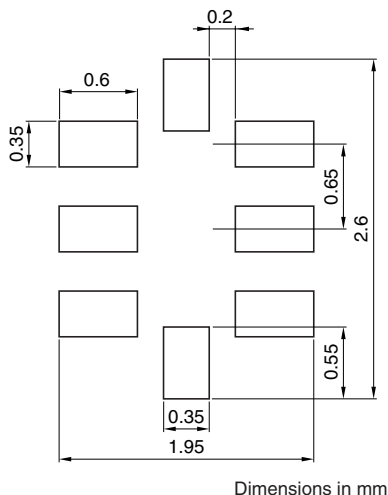

EVALUATION BOARD

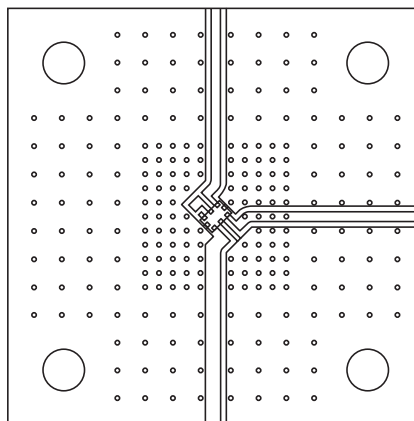

Port extension value is 139.56ps for all port.

• Conformity to RoHS Directive: This means that, in conformity with EU Directive 2002/95/EC, lead, cadmium, mercury, hexavalent chromium, and specific bromine-based flame retardants, PBB and PBDE, have not been used, except for exempted applications.

• All specifications are subject to change without notice.

ELECTRICAL CHARACTERISTICS

Item		Minimum value	Typical value	Maximum value
Frequency range(Pass band)	(MHz)	2400	—	2500
Insertion loss	[+25°C]	—	—	2.5
	[-40 to +85°C]	—	—	2.8
Single ended port characteristic impedance	(Ω)	50[Nominal]		
Balanced port differential characteristics impedance	(Ω)	50+j40		
Attenuation	[10 to 915MHz]	(dB)	41	—
	[925 to 960MHz]	(dB)	34	—
	[1570 to 1580MHz]	(dB)	30	—
	[1710 to 1785MHz]	(dB)	40	—
	[1805 to 1880MHz]	(dB)	26	—
	[1850 to 1910MHz]	(dB)	40	—
	[1920 to 1990MHz]	(dB)	31	—
	[4800 to 5000MHz]	(dB)	25	—
Single ended return loss	[2400 to 2500MHz]	(dB)	9	—
Balanced return loss	[2400 to 2500MHz]	(dB)	9	—
Phase difference at balanced port	[2400 to 2500MHz]	(deg.)	170	—
Amplitude imbalance at balanced port	[2400 to 2500MHz]	(dB)	-2	2
Common mode attenuation	[88 to 108MHz]	(dB)	15	—
	[4800 to 5000MHz]	(dB)	18	—
Common mode impedance [4900MHz]	Magnitude		0.6	—
	Angle	(deg.)	15	75
Power capacity		(mW)	—	500
Temperature range	Operating	(°C)	-40	+85
	Storage	(°C)	-40	+85

• Ta:+25°C

FREQUENCY CHARACTERISTICS

Unbalance 50Ω/Balance 50+j40Ω

SDS21 INSERTION LOSS

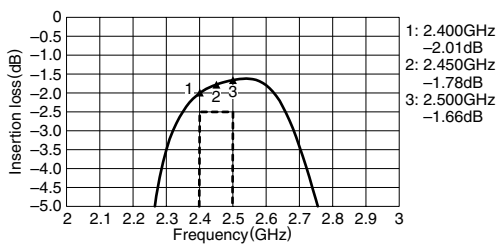

SDS21 ATTENUATION

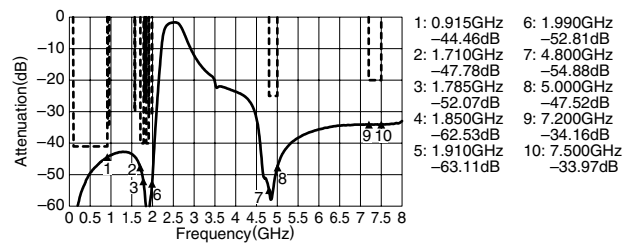

AMPLITUDE BALANCE

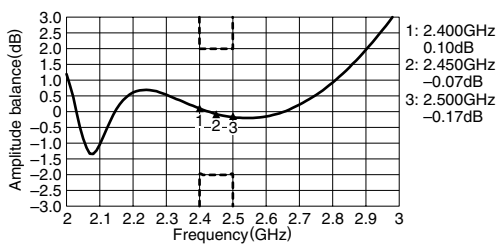

PHASE BALANCE

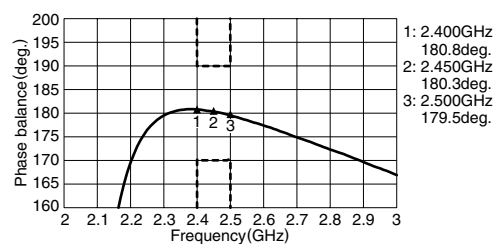

S11 UNBALANCE RETURN LOSS

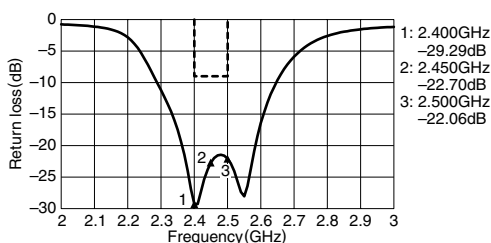

SDD22 BALANCE RETURN LOSS

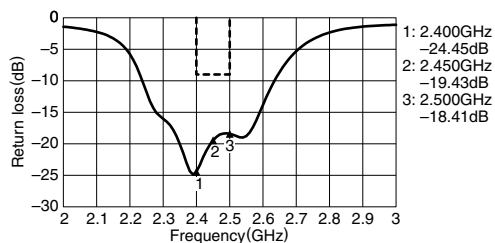

• All specifications are subject to change without notice.

FREQUENCY CHARACTERISTICS

Unbalance 50Ω/Balance 50+j40Ω

SCS21 ATTENUATION

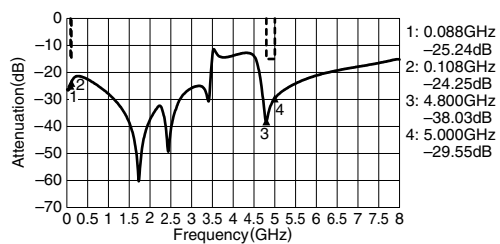

SCC22 ANGLE

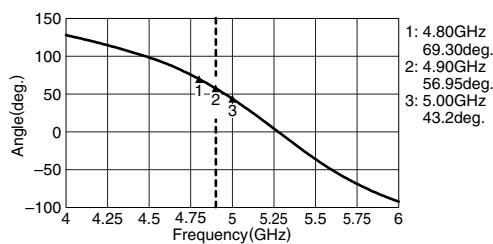

SCC22 MAGNITUDE

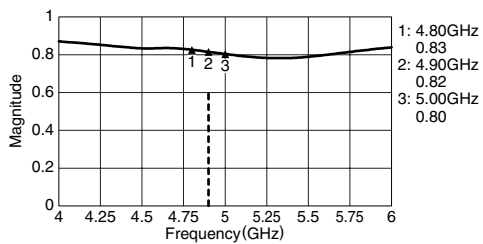

SMITH CHARTS

S11

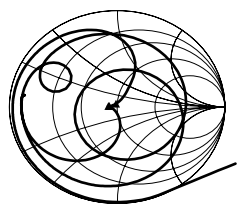

SDD22

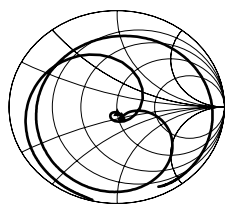

Компания «Океан Электроники» предлагает заключение долгосрочных отношений при поставках импортных электронных компонентов на взаимовыгодных условиях!

Наши преимущества:

- Поставка оригинальных импортных электронных компонентов напрямую с производств Америки, Европы и Азии, а так же с крупнейших складов мира;
- Широкая линейка поставок активных и пассивных импортных электронных компонентов (более 30 млн. наименований);
- Поставка сложных, дефицитных, либо снятых с производства позиций;
- Оперативные сроки поставки под заказ (от 5 рабочих дней);
- Экспресс доставка в любую точку России;
- Помощь Конструкторского Отдела и консультации квалифицированных инженеров;
- Техническая поддержка проекта, помощь в подборе аналогов, поставка прототипов;
- Поставка электронных компонентов под контролем ВП;
- Система менеджмента качества сертифицирована по Международному стандарту ISO 9001;
- При необходимости вся продукция военного и аэрокосмического назначения проходит испытания и сертификацию в лаборатории (по согласованию с заказчиком);
- Поставка специализированных компонентов военного и аэрокосмического уровня качества (Xilinx, Altera, Analog Devices, Intersil, Interpoint, Microsemi, Actel, Aeroflex, Peregrine, VPT, Syfer, Eurofarad, Texas Instruments, MS Kennedy, Miteq, Cobham, E2V, MA-COM, Hittite, Mini-Circuits, General Dynamics и др.);

Компания «Океан Электроники» является официальным дистрибьютором и эксклюзивным представителем в России одного из крупнейших производителей разъемов военного и аэрокосмического назначения «JONHON», а так же официальным дистрибьютором и эксклюзивным представителем в России производителя высокотехнологичных и надежных решений для передачи СВЧ сигналов «FORSTAR».



JONHON

«JONHON» (основан в 1970 г.)

Разъемы специального, военного и аэрокосмического назначения:

(Применяются в военной, авиационной, аэрокосмической, морской, железнодорожной, горно- и нефтедобывающей отраслях промышленности)

«FORSTAR» (основан в 1998 г.)

ВЧ соединители, коаксиальные кабели,
кабельные сборки и микроволновые компоненты:

(Применяются в телекоммуникациях гражданского и специального назначения, в средствах связи, РЛС, а так же военной, авиационной и аэрокосмической отраслях промышленности).



Телефон: 8 (812) 309-75-97 (многоканальный)

Факс: 8 (812) 320-03-32

Электронная почта: ocean@oceanchips.ru

Web: <http://oceanchips.ru/>

Адрес: 198099, г. Санкт-Петербург, ул. Калинина, д. 2, корп. 4, лит. А