

---

**SMALL PACKAGE  
VOLTAGE REGULATOR  
RQ5RW SERIES**

**APPLICATION MANUAL**

**RICOH**

**ELECTRONIC DEVICES DIVISION**

---

NO. EA-048-9803

## NOTICE

---

1. The products and the product specifications described in this application manual are subject to change or discontinuation of production without notice for reasons such as improvement. Therefore, before deciding to use the products, please refer to Ricoh sales representatives for the latest information thereon.
2. This application manual may not be copied or otherwise reproduced in whole or in part without prior written consent of Ricoh.
3. Please be sure to take any necessary formalities under relevant laws or regulations before exporting or otherwise taking out of your country the products or the technical information described herein.
4. The technical information described in this application manual shows typical characteristics of and example application circuits for the products. The release of such information is not to be construed as a warranty of or a grant of license under Ricoh's or any third party's intellectual property rights or any other rights.
5. The products listed in this document are intended and designed for use as general electronic components in standard applications (office equipment, computer equipment, measuring instruments, consumer electronic products, amusement equipment etc.). Those customers intending to use a product in an application requiring extreme quality and reliability, for example, in a highly specific application where the failure or misoperation of the product could result in human injury or death (aircraft, spacevehicle, nuclear reactor control system, traffic control system, automotive and transportation equipment, combustion equipment, safety devices, life support system etc.) should first contact us.
6. We are making our continuous effort to improve the quality and reliability of our products, but semiconductor products are likely to fail with certain probability. In order prevent any injury to persons or damages to property resulting from such failure, customers should be careful enough to incorporate safety measures in their design, such as redundancy feature, fire-containment feature and fail-safe feature. We do not assume any liability or responsibility for any loss or damage arising from misuse or inappropriate use of the products.
7. Anti-radiation design is not implemented in the products described in this application manual.
8. Please contact Ricoh sales representatives should you have any questions or comments concerning the products or the technical information.

June 1995

# RQ5RW SERIES

## APPLICATION MANUAL

### CONTENTS

---

<b>OUTLINE</b> .....	<b>1</b>
<b>FEATURES</b> .....	<b>1</b>
<b>APPLICATIONS</b> .....	<b>1</b>
<b>BLOCK DIAGRAM</b> .....	<b>2</b>
<b>SELECTION GUIDE</b> .....	<b>2</b>
<b>PIN CONFIGURATION</b> .....	<b>3</b>
<b>PIN DESCRIPTION</b> .....	<b>3</b>
<b>ABSOLUTE MAXIMUM RATINGS</b> .....	<b>3</b>
<b>ELECTRICAL CHARACTERISTICS</b> .....	<b>4</b>
<b>ELECTRICAL CHARACTERISTICS BY OUTPUT VOLTAGE</b> .....	<b>6</b>
<b>ELECTRICAL CHARACTERISTICS BY OUTPUT VOLTAGE</b> <b>(common characteristics)</b> .....	<b>7</b>
<b>OPERATION</b> .....	<b>7</b>
<b>TEST CIRCUITS</b> .....	<b>8</b>
<b>TYPICAL CHARACTERISTICS</b> .....	<b>9</b>
1) Output Voltage vs. Output Current .....	<b>9</b>
2) Output Voltage vs. Input Voltage .....	<b>10</b>
3) Dropout Voltage vs. Output Current .....	<b>11</b>
4) Output Voltage vs. Temperature .....	<b>11</b>
5) Supply Current vs. Input Voltage .....	<b>12</b>
6) Supply Current vs. Temperature .....	<b>13</b>
7) Dropout Voltage vs. Set Output Voltage .....	<b>13</b>
8) Line Transient Response .....	<b>14</b>
9) Load Transient Response .....	<b>15</b>
10) Ripple Rejection .....	<b>16</b>

---

---

<b>TYPICAL APPLICATION</b> .....	<b>17</b>
<b>PACKAGE DIMENSION</b> .....	<b>17</b>
<b>TAPING SPECIFICATION</b> .....	<b>18</b>

---

**RQ5RW SERIES**

---

**OUTLINE**

The RQ5RW Series are voltage regulator ICs with high accuracy output voltage and ultra-low supply current developed by CMOS process. Each of these ICs consists of a voltage reference unit, an error amplifier, resistors for setting output voltage and a current limit circuit.

The output voltage of these ICs is fixed with high accuracy.

Even if  $V_{OUT}$  is shorted to GND, the included current limit circuit protects the ICs from the destruction.

Furthermore, these ICs have a chip enable function, so that the supply current on standby can be minimized.

Since the package for these ICs are SC-82AB (Super Mini-mold) package, high density mounting of the ICs on boards is possible.

**FEATURES**

- Ultra-Low Supply Current.....TYP. 1.5 $\mu$ A
- Standby Current .....TYP. 0.1 $\mu$ A
- Dropout Voltage.....TYP. 40mV ( $I_{OUT}=1mA$ , RQ5RW30A/B)
- Low Temperature-Drift Coefficient of  
Output Voltage.....TYP.  $\pm 100ppm/^{\circ}C$
- Excellent Line Regulation.....TYP. 0.05%/V
- High Accuracy Output Voltage..... $\pm 2.0\%$
- Ultra-Small Package .....SC-82AB (Super Mini-mold)
- Built-in Current Limit Circuits

**APPLICATIONS**

- Power source for battery-powered equipment.
- Power source for cameras, VCRs, camcorders, hand-held audio instruments and hand-held communication equipment.
- Precision voltage references.

## BLOCK DIAGRAM



## SELECTION GUIDE

The output voltage, the active type, the packing type and the taping type for the ICs can be selected at the user's request. The selection can be made by designating the part number as shown below:

RQ5RW  $\times\times\times\times$ - $\times\times$  ← Part Number  
 $\uparrow \uparrow \uparrow \uparrow$   
 a b c d

Code	Contents
a	Setting Output Voltage (VOUT) : Stepwise setting with a step of 0.1V in the range of 2.0V to 6.0V is possible.
b	Designation of Chip enable Active Type : A : "L" active type B : "H" active type
c	Designation of Packing Type : A : Taping B : Antistatic bag (for Sample only)
d	Designation of Taping Type : TR (refer to Taping Specifications)

## PIN CONFIGURATION



## PIN DESCRIPTION

Pin No.	Symbol	Pin Description
1	GND	Ground Pin
2	V <sub>DD</sub>	Input Pin
3	V <sub>OUT</sub>	Output Pin
4	$\overline{\text{CE}}$ or CE	Chip Enable Pin

## ABSOLUTE MAXIMUM RATINGS

Symbol	Item	Rating	Unit
V <sub>IN</sub>	Input Voltage	9	V
V <sub>CE</sub>	Input Voltage for CE/ $\overline{\text{CE}}$ Pin	-0.3 to V <sub>IN</sub> +0.3	V
V <sub>OUT</sub>	Output Voltage	-0.3 to V <sub>IN</sub> +0.3	V
I <sub>OUT</sub>	Output Current	150	mA
P <sub>D</sub>	Power Dissipation	150	mW
T <sub>opt</sub>	Operating Temperature	-40 to +85	°C
T <sub>stg</sub>	Storage Temperature	-55 to +125	°C

### ABSOLUTE MAXIMUM RATINGS

Absolute Maximum ratings are threshold limit values that must not be exceeded even for an instant under any conditions. Moreover, such values for any two items must not be reached simultaneously. Operation above these absolute maximum ratings may cause degradation or permanent damage to the device. These are stress ratings only and do not necessarily imply functional operation below these limits.

## ELECTRICAL CHARACTERISTICS

## • RQ5RW30A

T<sub>opt</sub>=25°C

Symbol	Item	Conditions	MIN.	TYP.	MAX.	Unit
V <sub>OUT</sub>	Output Voltage	V <sub>IN</sub> =5.0V 10μA≤I <sub>OUT</sub> ≤10mA	2.940	3.000	3.060	V
I <sub>OUT</sub>	Output Current	V <sub>IN</sub> =5.0V	50			mA
$\frac{\Delta V_{OUT}}{\Delta I_{OUT}}$	Load Regulation	V <sub>IN</sub> =5.0V 1mA≤I <sub>OUT</sub> ≤50mA		40	60	mV
V <sub>DIF</sub>	Dropout Voltage	I <sub>OUT</sub> =1mA		40	60	mV
I <sub>SS</sub>	Supply Current	V <sub>IN</sub> =5.0V		1.5	3.0	μA
I <sub>standby</sub>	Standby Current	V <sub>IN</sub> =5.0V, V <sub>CE</sub> =5.0V		0.1	1.0	μA
$\frac{\Delta V_{OUT}}{\Delta V_{IN}}$	Line Regulation	I <sub>OUT</sub> =1mA V <sub>OUT</sub> +0.5V≤V <sub>IN</sub> ≤8V	0	0.05	0.20	%/V
V <sub>IN</sub>	Input Voltage				8.0	V
$\frac{\Delta V_{OUT}}{\Delta T_{opt}}$	Output Voltage Temperature Coefficient	I <sub>OUT</sub> =10mA -40°C≤T <sub>opt</sub> ≤85°C		±100		ppm/°C
I <sub>lim</sub>	Short Current Limit			40		mA
R <sub>PU</sub>	Pull up resistance for $\overline{CE}$ pin		1.5	4.0	12.0	MΩ
V <sub>CEH</sub>	$\overline{CE}$ Input Voltage "H"		1.5			V
V <sub>CEL</sub>	$\overline{CE}$ Input Voltage "L"				0.25	V



## • RQ5RW30B

T<sub>opt</sub>=25°C

Symbol	Item	Conditions	MIN.	TYP.	MAX.	Unit
V <sub>OUT</sub>	Output Voltage	V <sub>IN</sub> =5.0V 10μA≤I <sub>OUT</sub> ≤10mA	2.940	3.000	3.060	V
I <sub>OUT</sub>	Output Current	V <sub>IN</sub> =5.0V	50			mA
$\frac{\Delta V_{OUT}}{\Delta I_{OUT}}$	Load Regulation	V <sub>IN</sub> =5.0V 1mA≤I <sub>OUT</sub> ≤50mA		40	60	mV
V <sub>DIF</sub>	Dropout Voltage	I <sub>OUT</sub> =1mA		40	60	mV
I <sub>SS</sub>	Supply Current	V <sub>IN</sub> =5.0V		1.5	3.0	μA
I <sub>standby</sub>	Standby Current	V <sub>IN</sub> =5.0V, V <sub>CE</sub> =GND		0.1	1.0	μA
$\frac{\Delta V_{OUT}}{\Delta V_{IN}}$	Line Regulation	I <sub>OUT</sub> =1mA V <sub>OUT</sub> +0.5V≤V <sub>IN</sub> ≤8V	0	0.05	0.20	%/V
V <sub>IN</sub>	Input Voltage				8.0	V
$\frac{\Delta V_{OUT}}{\Delta T_{opt}}$	Output Voltage Temperature Coefficient	I <sub>OUT</sub> =1mA -40°C≤T <sub>opt</sub> ≤85°C		±100		ppm/°C
I <sub>lim</sub>	Short Current Limit			40		mA
R <sub>PD</sub>	Pull down resistance for CE pin		1.5	4.0	12.0	MΩ
V <sub>CEH</sub>	CE Input Voltage "H"		1.5			V
V <sub>CEL</sub>	CE Input Voltage "L"				0.25	V

## ELECTRICAL CHARACTERISTICS BY OUTPUT VOLTAGE

T<sub>opt</sub>=25°C

Part Number	Output Voltage				Output Current			Load Regulation			Dropout Voltage		
	V <sub>out</sub> (V)				I <sub>out</sub> (mA)			ΔV <sub>out</sub> /ΔI <sub>out</sub> (mV)			V <sub>DIF</sub> (mV)		
	Conditions	MIN.	TYP.	MAX.	Conditions	MIN.	TYP.	Conditions	TYP.	MAX.	Conditions	TYP.	MAX.
RQ5RW20	V <sub>IN</sub> - V <sub>OUT</sub> =2.0V  10μA≤ I <sub>OUT</sub> ≤10mA	1.960	2.000	2.040	V <sub>IN</sub> - V <sub>OUT</sub> =2.0V	35		V <sub>IN</sub> - V <sub>OUT</sub> =2.0V  1mA≤ I <sub>OUT</sub> ≤35mA	30	45	I <sub>OUT</sub> =1mA	60	90
RQ5RW21		2.058	2.100	2.142									
RQ5RW22		2.156	2.200	2.244									
RQ5RW23		2.254	2.300	2.346									
RQ5RW24		2.352	2.400	2.448									
RQ5RW25		2.450	2.500	2.550									
RQ5RW26		2.548	2.600	2.652									
RQ5RW27		2.646	2.700	2.754									
RQ5RW28		2.744	2.800	2.856									
RQ5RW29		2.842	2.900	2.958									
RQ5RW30		2.940	3.000	3.060									
RQ5RW31		3.038	3.100	3.162									
RQ5RW32		3.136	3.200	3.264									
RQ5RW33		3.234	3.300	3.366									
RQ5RW34		3.332	3.400	3.468									
RQ5RW35		3.430	3.500	3.570									
RQ5RW36		3.528	3.600	3.672									
RQ5RW37		3.626	3.700	3.774									
RQ5RW38		3.724	3.800	3.876									
RQ5RW39		3.822	3.900	3.978									
RQ5RW40		3.920	4.000	4.080									
RQ5RW41		4.018	4.100	4.182									
RQ5RW42		4.116	4.200	4.284									
RQ5RW43		4.214	4.300	4.386									
RQ5RW44		4.312	4.400	4.488									
RQ5RW45		4.410	4.500	4.590									
RQ5RW46		4.508	4.600	4.692									
RQ5RW47		4.606	4.700	4.794									
RQ5RW48		4.704	4.800	4.896									
RQ5RW49		4.802	4.900	4.998									
RQ5RW50	4.900	5.000	5.100										
RQ5RW51	4.998	5.100	5.202										
RQ5RW52	5.096	5.200	5.304										
RQ5RW53	5.194	5.300	5.406										
RQ5RW54	5.292	5.400	5.508										
RQ5RW55	5.390	5.500	5.610										
RQ5RW56	5.488	5.600	5.712										
RQ5RW57	5.586	5.700	5.814										
RQ5RW58	5.684	5.800	5.916										
RQ5RW59	5.782	5.900	6.018										
RQ5RW60	5.880	6.000	6.120										
						65		V <sub>IN</sub> - V <sub>OUT</sub> =2.0V  1mA≤ I <sub>OUT</sub> ≤65mA	50	70	I <sub>OUT</sub> =1mA	25	40
						80		V <sub>IN</sub> - V <sub>OUT</sub> =2.0V  1mA≤ I <sub>OUT</sub> ≤80mA	60	90	I <sub>OUT</sub> =1mA	25	40

## ELECTRICAL CHARACTERISTICS BY OUTPUT VOLTAGE (common characteristics)

T<sub>opt</sub>=25°C

Symbol	Item	Conditions	MIN.	TYP.	MAX.	Unit
I <sub>SS</sub>	Supply Current	V <sub>IN</sub> =setV <sub>OUT</sub> +2.0V		1.5	3.0	μA
I <sub>standby</sub>	Standby Current	V <sub>IN</sub> =setV <sub>OUT</sub> +2.0V V <sub>CE</sub> =V <sub>IN</sub> (RQ5RW××A), V <sub>CE</sub> =GND(RQ5RW××B)		0.1	1.0	μA
$\frac{\Delta V_{OUT}}{\Delta V_{IN}}$	Line Regulation	I <sub>OUT</sub> =1mA setV <sub>OUT</sub> +0.5V ≤ V <sub>IN</sub> ≤ 8V	0	0.05	0.20	%/V
V <sub>IN</sub>	Input Voltage				8.0	V
$\frac{\Delta V_{OUT}}{\Delta T_{opt}}$	Output Voltage Temperature Coefficient	I <sub>OUT</sub> =10mA -40°C ≤ T <sub>opt</sub> ≤ 85°C		±100		ppm/°C
I <sub>lim</sub>	Short Current Limit			40		mA
R <sub>PU</sub> /R <sub>PD</sub>	$\overline{CE}$ Pull-up / CE Pull-down Resistance		1.5	4.0	12.0	MΩ
V <sub>CEH</sub>	$\overline{CE}$ /CE Input Voltage “H”		1.5			V
V <sub>CEL</sub>	$\overline{CE}$ /CE Input Voltage “L”				0.25	V

## OPERATION



In these ICs, Output Voltage V<sub>OUT</sub> is detected by Feed-back Registers R1, R2, and the detected Output Voltage is compared with a reference voltage by Error Amplifier, so that a constant voltage is output.

A current limit circuit working for Short Protect and a chip enable circuit are included.

## TEST CIRCUITS



Standard Test Circuit



Test Circuit for Supply Current



Test Circuit for Ripple Rejection and Line Transient Response



Test Circuit for Load Transient Response

## TYPICAL CHARACTERISTICS

### 1) Output Voltage vs. Output Current



2) Output Voltage vs. Input Voltage

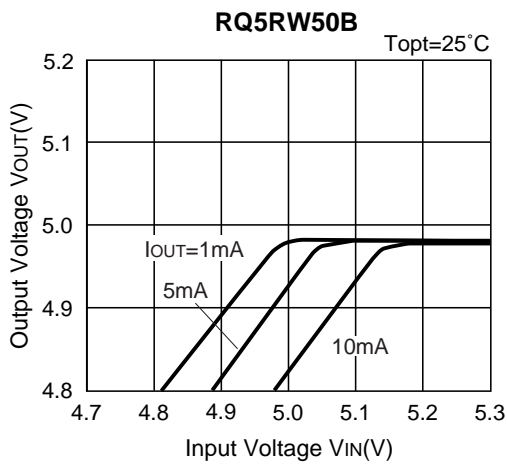
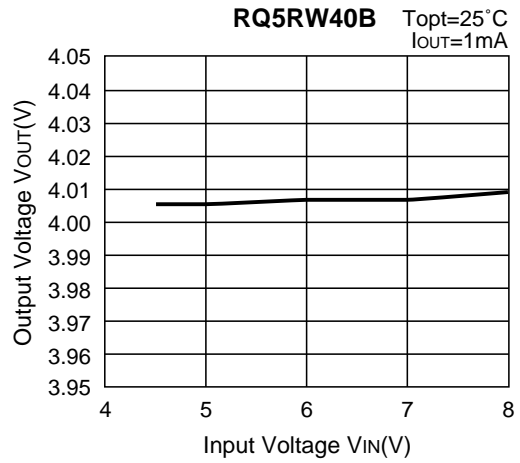
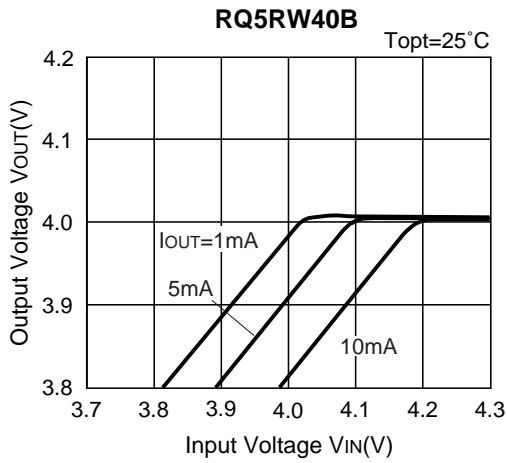
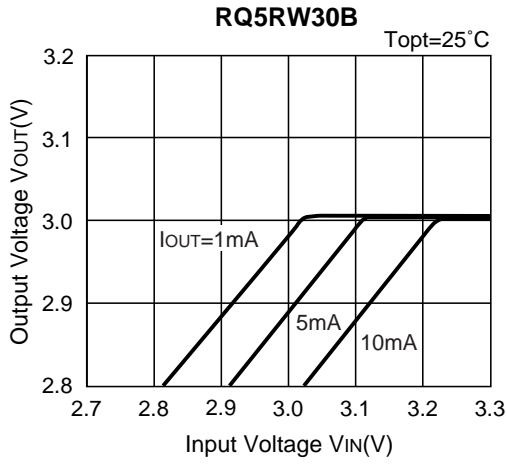

3) Dropout Voltage vs. Output Current



4) Output Voltage vs. Temperature





5) Supply Current vs. Input Voltage





6) Supply Current vs. Temperature

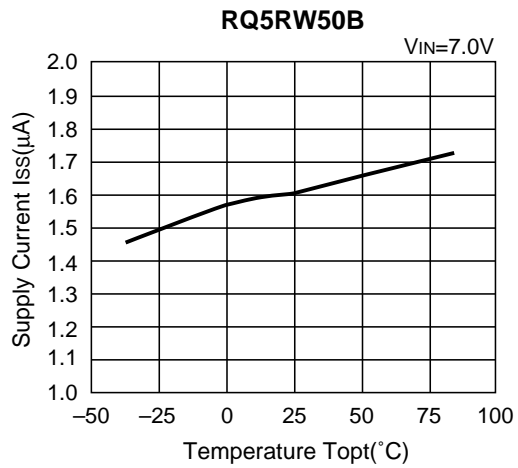
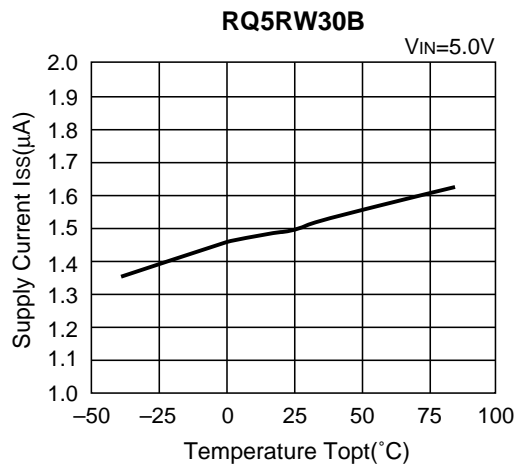

7) Dropout Voltage vs. Set Output Voltage

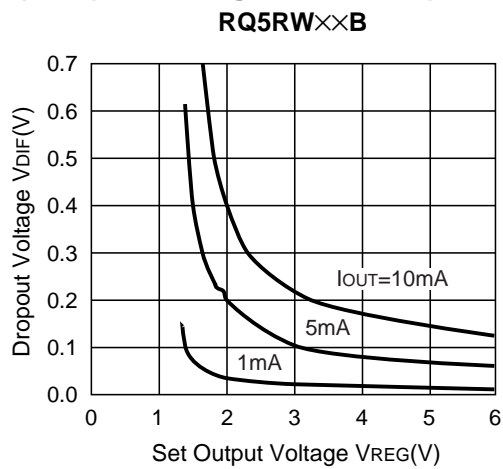

8) Line Transient Response



9) Load Transient Response



10) Ripple Rejection

**RQ5RW30B**

$V_{IN}=5V_{DC}+0.5V_{p-p}$   
 $I_{OUT}=10mA$   
 $C_{OUT}=1\mu F$



**RQ5RW40B**

$V_{IN}=6V_{DC}+0.5V_{p-p}$   
 $I_{OUT}=10mA$   
 $C_{OUT}=1\mu F$



**RQ5RW50B**

$V_{IN}=7V_{DC}+0.5V_{p-p}$   
 $I_{OUT}=10mA$   
 $C_{OUT}=1\mu F$



## TYPICAL APPLICATION



In RQ5RW Series, a constant voltage can be obtained without using Capacitor C1 and C2. However, when the wire connected  $V_{IN}$  is long, use Capacitor C1. Output noise can be reduced by using Capacitor 2.

Insert Capacitors C1 and C2 with the capacitance of  $0.1\mu\text{F}$  to  $0.2\mu\text{F}$  between Input/Output Pins and GND Pin with minimum wiring.

## PACKAGE DIMENSION (Unit : mm)

• SC-82AB



### TAPING SPECIFICATION (Unit : mm)

- SC82AB





---

**RICOH COMPANY, LTD.**  
**ELECTRONIC DEVICES DIVISION**

**HEADQUARTERS**

13-1, Himemuro-cho, Ikeda City, Osaka 563-8501, JAPAN  
Phone 81-727-53-1111 Fax 81-727-53-6011

**YOKOHAMA OFFICE** (International Sales)

3-2-3, Shin-Yokohama, Kohoku-ku, Yokohama City, Kanagawa 222-8530,  
JAPAN  
Phone 81-45-477-1697 Fax 81-45-477-1694 • 1695  
<http://www.ricoh.co.jp/LSI/english/>

**RICOH CORPORATION**  
**ELECTRONIC DEVICES DIVISION**

**SAN JOSE OFFICE**

3001 Orchard Parkway, San Jose, CA 95134-2088, U.S.A.  
Phone 1-408-432-8800 Fax 1-408-432-8375

Компания «Океан Электроники» предлагает заключение долгосрочных отношений при поставках импортных электронных компонентов на взаимовыгодных условиях!

Наши преимущества:

- Поставка оригинальных импортных электронных компонентов напрямую с производств Америки, Европы и Азии, а так же с крупнейших складов мира;
- Широкая линейка поставок активных и пассивных импортных электронных компонентов (более 30 млн. наименований);
- Поставка сложных, дефицитных, либо снятых с производства позиций;
- Оперативные сроки поставки под заказ (от 5 рабочих дней);
- Экспресс доставка в любую точку России;
- Помощь Конструкторского Отдела и консультации квалифицированных инженеров;
- Техническая поддержка проекта, помощь в подборе аналогов, поставка прототипов;
- Поставка электронных компонентов под контролем ВП;
- Система менеджмента качества сертифицирована по Международному стандарту ISO 9001;
- При необходимости вся продукция военного и аэрокосмического назначения проходит испытания и сертификацию в лаборатории (по согласованию с заказчиком);
- Поставка специализированных компонентов военного и аэрокосмического уровня качества (Xilinx, Altera, Analog Devices, Intersil, Interpoint, Microsemi, Actel, Aeroflex, Peregrine, VPT, Syfer, Eurofarad, Texas Instruments, MS Kennedy, Miteq, Cobham, E2V, MA-COM, Hittite, Mini-Circuits, General Dynamics и др.);

Компания «Океан Электроники» является официальным дистрибьютором и эксклюзивным представителем в России одного из крупнейших производителей разъемов военного и аэрокосмического назначения «JONHON», а так же официальным дистрибьютором и эксклюзивным представителем в России производителя высокотехнологичных и надежных решений для передачи СВЧ сигналов «FORSTAR».



## JONHON

«JONHON» (основан в 1970 г.)

Разъемы специального, военного и аэрокосмического назначения:

(Применяются в военной, авиационной, аэрокосмической, морской, железнодорожной, горно- и нефтедобывающей отраслях промышленности)

«FORSTAR» (основан в 1998 г.)

ВЧ соединители, коаксиальные кабели, кабельные сборки и микроволновые компоненты:

(Применяются в телекоммуникациях гражданского и специального назначения, в средствах связи, РЛС, а так же военной, авиационной и аэрокосмической отраслях промышленности).



Телефон: 8 (812) 309-75-97 (многоканальный)

Факс: 8 (812) 320-03-32

Электронная почта: [ocean@oceanchips.ru](mailto:ocean@oceanchips.ru)

Web: <http://oceanchips.ru/>

Адрес: 198099, г. Санкт-Петербург, ул. Калинина, д. 2, корп. 4, лит. А