

# ISL78424EVAL3Z, ISL78434EVAL1Z

User's Manual: Evaluation Board

Automotive

## 1. Overview

The ISL78424EVAL3Z and ISL78434EVAL1Z evaluation boards are designed to provide a quick and comprehensive method for evaluating the [ISL78424](#) and [ISL78434](#) 100V 3A source, 4A sink half-bridge drivers for driving the gates of two NMOS FETs in a half-bridge configuration. Two N-channel MOSFETs are included on the evaluation board to allow for the evaluation of a half-bridge driven load such as a DC motor or a synchronous switching regulator.

The ISL784x4 family of FET drivers are offered in a 14 Ld HTSSOP package enhanced with a thermal EPAD. They operate from a supply voltage of 8V to 18V DC with the capability of driving a high-side N-channel FET in a 70V half-bridge configuration. A unique tri-level PWM input (ISL78424 only) allows control of both the high-side and low-side gate drivers with a single input. If the PWM pin is left floating, internal pull-up and pull-down resistors bias the PWM pin to the mid-level state. The mid-level state has both high-side and low-side sink drivers active to disable both MOSFETs. This is beneficial for multiphase DC/DC converters that require phase dropping or to implement asynchronous operation in a synchronous DC/DC converter. The ISL78434 has independent HI and LI driving pins that control their respective FET output driver signal. The ISL78434 features an input lockout protection to prevent both driver outputs going active high at the same time. The driver locks out any input logic from propagating to that driver output if the other input is already logic high.

The ISL78424 and ISL78434 feature separate pins for the sourcing and sinking driver outputs. The HO\_H and HO\_L are the high-side sourcing and sinking drivers, respectively. The LO\_H and LO\_L are the low-side sourcing and sinking drivers, respectively. Separate source and sink output pins allow optimizing the FET turn on/off times using gate drive limiting resistors

### 1.1 Key Features

- 3A source and 4A sink NMOS gate drivers
- Internal level shifter and bootstrap switch for gate driver on high-side FET
- Up to 70V high-side gate drive reference
- 8V to 18V bias supply operation
- Single PWM input for high-side and low-side gate driver with tri-level for turning off both drivers, (ISL78424 only)
- Independent HI and LI inputs for high-side and low-side gate driver, (ISL78434 only)
- Single resistor adjustable dead time from 35ns to 400ns, (ISL78424 only)

### 1.2 Specifications

These boards are optimized for the following operating conditions:

- $V_{DD}$  supply = 8V to 18V
- $V_{BRIDGE}$  supply input = 12V to 70V
- PWM switching frequency 10kHz to 1MHz
- Preset half-bridge dead time: 165ns with RDT = 10k $\Omega$ , (Adaptive dead time + programmable dead time)
- Peak gate drive current: 3A source and 4A sink

### 1.3 Ordering Information

Part Number	Description
ISL78424EVAL3Z	ISL78424AVEZ evaluation board
ISL78434EVAL1Z	ISL78434AVEZ evaluation board

### 1.4 Related Literature

For a full list of related documents, visit our website:

- [ISL78424](#), [ISL78434](#), [ISL78444](#), [ISL78224](#), [ISL78226](#) product pages

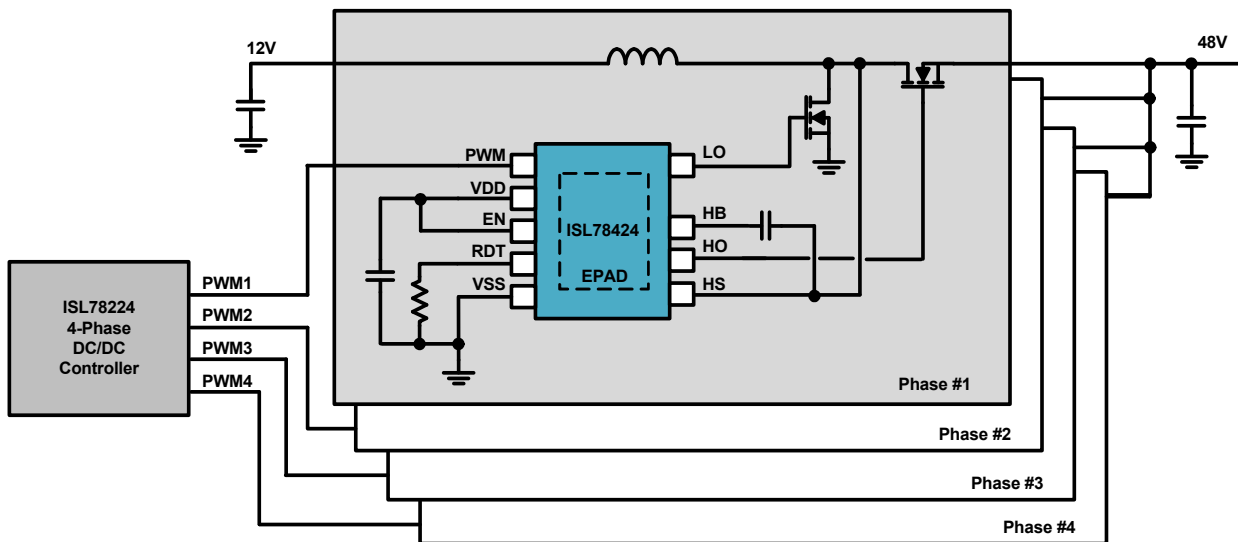

Figure 1. ISL78424EVAL3Z Block Diagram

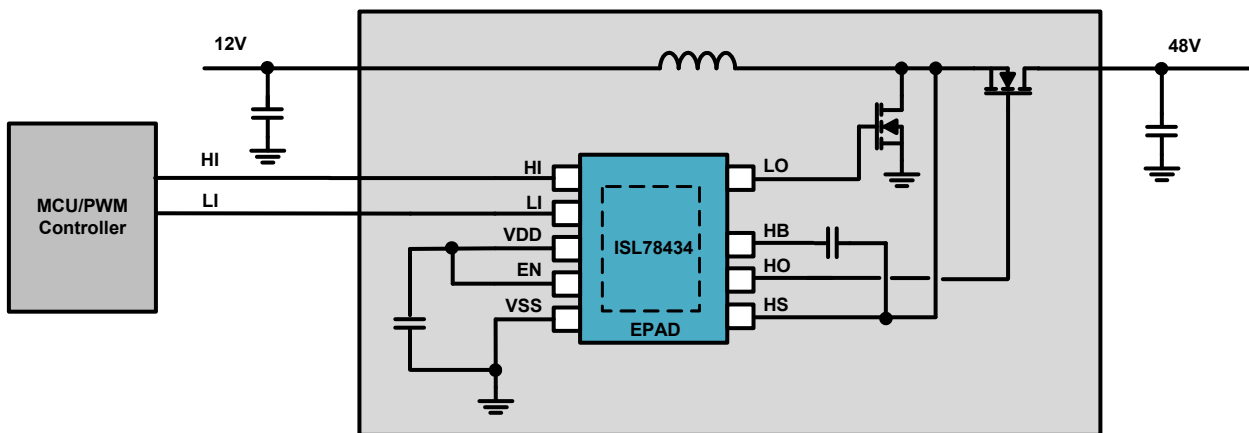

Figure 2. ISL78434EVAL1Z Block Diagram

## 2. Functional Description

The ISL78424EVAL3Z and ISL78434EVAL1Z are designed to provide a comprehensive and versatile platform for a user to evaluate the functionality and prototype an application of the ISL784x4 FET drivers. These evaluation boards provide an open loop type of application for either synchronous buck or boost applications where the output voltage is controlled using the duty cycle of the PWM pin for the ISL78424EVAL3Z, and by the ratio of the HI and LI signals for the ISL78434EVAL1Z (Note the ISL78434 has protections that prevent the HO and LO from both being in “High” logic state if both of these signals are asserted high).

### 2.1 Operating Range

The ISL784x4 FET drivers offer voltage ratings that are ideal for 48V automotive systems. The switching node (HS) can operate at voltages up to 70V, and can tolerate infrequent transient voltages up to 86V. The bootstrap (HB) node, supply to the high-side driver, can operate at a voltage of up to 86V, and can handle infrequent transients up to 100V. The logic pins of the ISL784x4 driver family are tolerant up to maximum  $V_{DD}$  of 18V. The gate drive of the high and low-side drivers is provided by  $V_{DD}$ .

### 2.2 Recommended Equipment

- 8V to 18V power supply with at least 2A source current capability
- 0V to 70V power supply to bias the half bridge
- 100kHz to 1MHz square wave generator with 0V to 5V logic levels output
- Minimum 4-channel oscilloscope to verify PWM, HO, LO, and HS signals
- Load such as DC motor, or electronic load (optional)

### 2.3 Quick Start Guide

- (1) The dead time of the HO and LO signal is set to 110ns with a 10k $\Omega$  resistor from the RDT pin to GND. To change the dead time, replace the resistor at R10 with the value corresponding to the desired dead time.
- (2) Ensure that the enable switch (SW<sub>1</sub>) is set to the off position.
- (3) Connect the power supply capable of 48V and 10A to VBAT\_48V terminals {J<sub>19</sub>(+) and J<sub>20</sub>(-)}. Turn on supply to 48V.
- (4) Connect 8V to 18V supply to the VDD terminals on board {J<sub>2</sub>(+) and J<sub>3</sub>(-)}. Turn on supply to 12V.
- (5) For ISL78424: Connect a 0V to 5V (PWM pin capable of voltage up to  $V_{DD}$ ) <500kHz square wave signal to PWM BNC connector J<sub>13</sub>, shunt jumper J<sub>10</sub> not needed.  
For ISL78434: Apply the HI signal to the BNC connector J<sub>9</sub>, the LI signal at the J<sub>13</sub> BNC connector, and connect the shunt jumper to J<sub>10</sub> (HI/LI pins capable of voltage up to  $V_{DD}$ ).
- (6) Toggle enable switch (SW<sub>1</sub>) to the on position.
- (7) Verify HO and LO outputs are switching. LO switches between GND and VDD (12V for this example) phase inverted from PWM. HO switches between GND and  $V_{HB} + V_{BRIDGE}$  (48V in this example) in phase with PWM.

## 2.4 Dead Time Measurement

- (1) Ensure that there is no bandwidth limitation on any of the channels of the oscilloscope and they are set up to 5V/div.
- (2) Connect a probe to the LO signal on J<sub>1</sub> (2 pin header, GND(-) towards top of board, LO(+) signal towards bottom of board).
- (3) Connect a probe to the HO signal on J<sub>6</sub> (2 pin header, GND(-) towards top of board, HO(+) signal towards bottom of board).
- (4) Connect a probe to the HS signal on J<sub>5</sub> (2 pin header, GND(-) towards left of board, HS(+) signal towards right of board).
- (5) Add a math measurement to the scope and subtract the HO-HS signals.
- (6) Dead time measurement  $t_{DTHL}$  = time from 50% level of (HO-HS) signal falling to 50% level of LO signal rising. With  $R_{DT} = 10k\Omega$ , default configuration of board, the  $t_{DTHL} = 180ns$  (adaptive dead time ( $t_{ADTC}$ ) + resistor programmed dead time ( $t_{DTHL}$ )).
- (7) Dead time measurement  $t_{DTLH}$  = time from 50% level of LO signal falling to 50% level of (HO-HS) signal rising. With  $R_{DT} = 10k\Omega$ , default configuration of board, the  $t_{DTLH} = 180ns$  (adaptive dead time ( $t_{ADTC}$ ) + resistor programmed dead time ( $t_{DTHL}$ )).

### 3. PCB Layout Guidelines

- (1) For best thermal performance, connect the driver EPAD to a low thermal impedance ground plane. Use as many vias as possible to connect the top layer Printed Circuit Board (PCB) thermal land to ground planes on other PCB layers. For best electrical performance, connect the VSS and AGND pins together through the EPAD to maintain a low impedance connection between the two pins.
- (2) When adjustable dead time is used (ISL78424 only), connect the resistor to the RDT pin and GND plane close to the IC to minimize ground noise from disrupting the timing performance.
- (3) Place the VDD decoupling capacitors and bootstrap capacitors close to the VDD-VSS and HB-HS pins, respectively. Use decoupling capacitors to reduce the influence of parasitic inductors. To be effective, these capacitors must also have the shortest possible lead lengths. If vias are used, connect several paralleled vias to reduce the inductance.
- (4) Keep power loops as short as possible by paralleling the source and return traces.
- (5) Adding resistance might be necessary to dampen resonating parasitic circuits. In PCB designs with long leads on the LO and HO outputs, add series gate resistors on the bridge FETs to dampen the oscillations.
- (6) Large power components (power FETs, electrolytic capacitors, power resistors, etc.) have internal parasitic inductance that cannot be eliminated. This must be accounted for in the PCB layout and circuit design.
- (7) If you simulate your circuits, consider including parasitic components.

#### 3.1 ISL78424EVAL3Z Evaluation Board

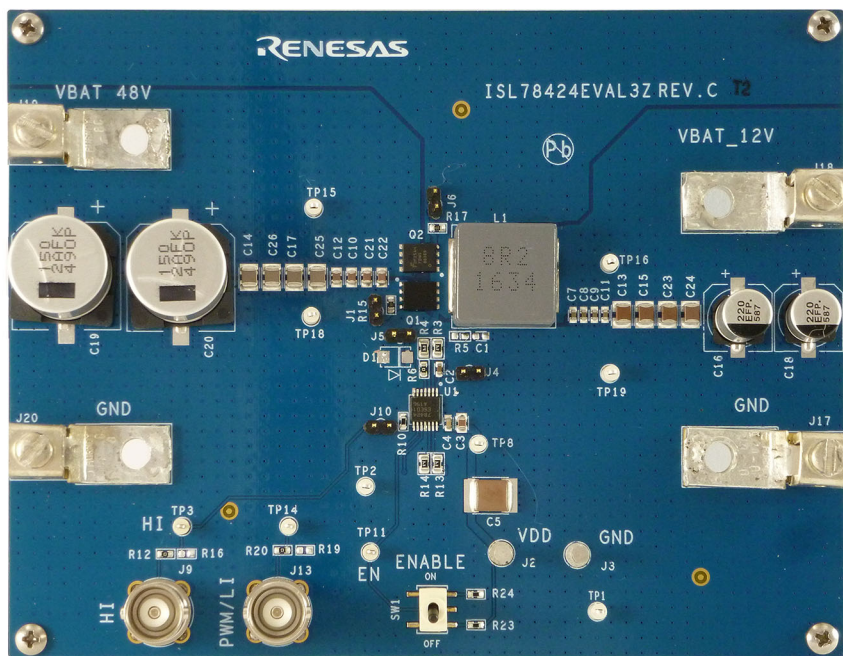

Figure 3. ISL78424EVAL3Z Evaluation Board

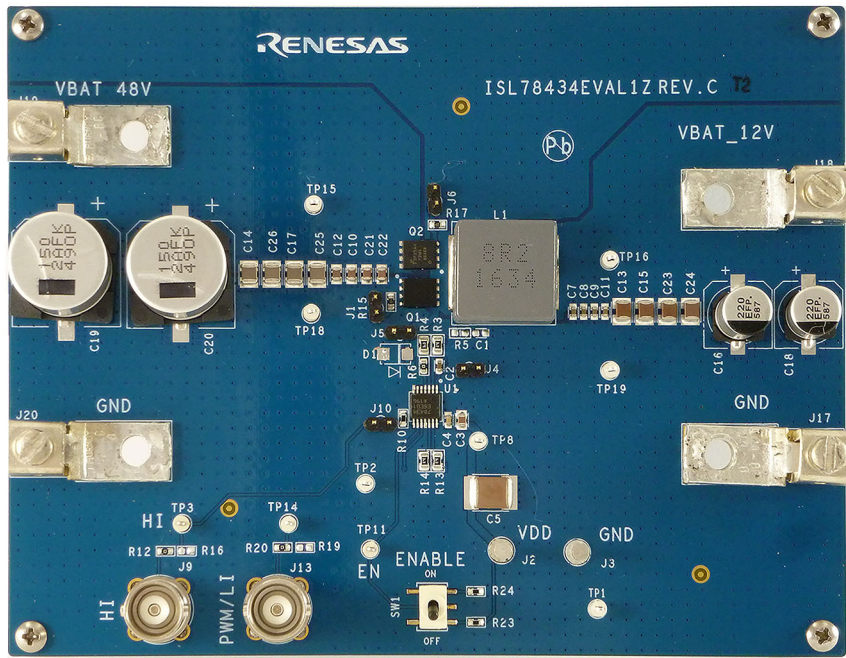

Figure 4. ISL78434EVAL1Z Evaluation Board

### 3.2 ISL78424EVAL3Z Circuit Schematic

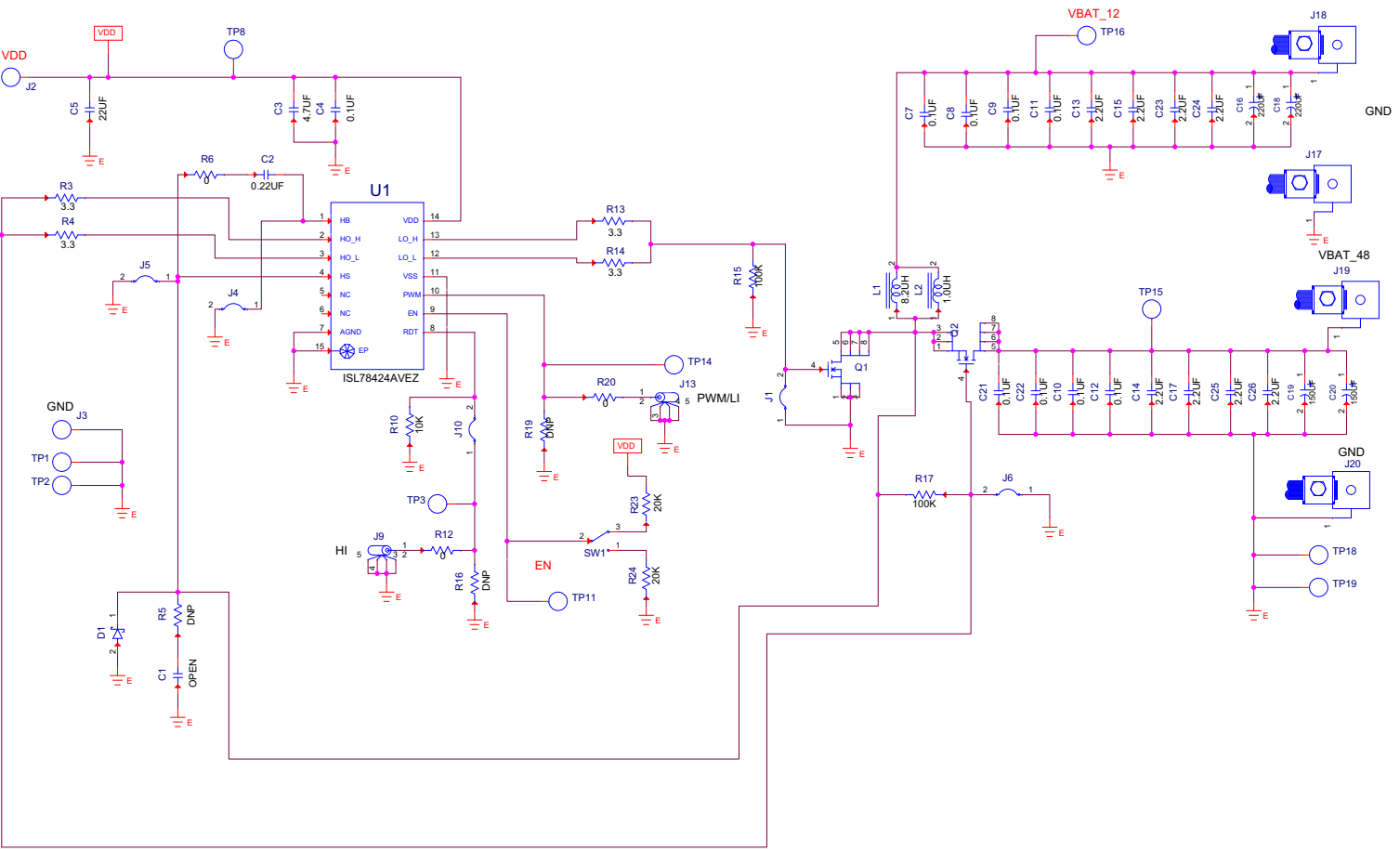

Figure 5. ISL78424EVAL3Z Schematic





### 3.4 Bill of Materials: ISL78424EVAL3Z and ISL78434EVAL1Z

Qty	Reference Designator	Description	Manufacturer	Manufacturer Part Number
1	U1	IC-4A, 86V, HALF-BRIDGE DRIVER, 14P, HTSSOP, ROHS	Renesas	ISL78424AVEZ for ISL78424EVAL3Z ISL78434AVEZ for ISL78434EVAL1Z
1	C5	CAPACITOR, SMD, 2220, 22 $\mu$ F, 25V, 20%, X7R, ROHS	TDK	C5750X7R1E226M
1	C3	CAP-AEC-Q200, SMD, 0805, 4.7 $\mu$ F, 35V, 10%, X7R, ROHS	TDK	CGA4J1X7R1V475K125AE
4	C10, C12, C21, C22	CAP-AEC-Q200, SMD, 0805, 0.1 $\mu$ F, 100V, 10%, X7R, ROHS	TDK	CGA4J2X7R2A104K125AA
2	C19, C20	CAP, SMD, 17X17, 150 $\mu$ F, 100V, 20%, ALUM.ELEC., ROHS	Panasonic	EEV-FK2A151M
4	C7-C9, C11	CAP, SMD, 0603, 0.1 $\mu$ F, 25V, 10%, X7R, ROHS	Yageo	CC0603KRX7R8BB104
1	C4	CAP, SMD, 0603, 0.1 $\mu$ F, 25V, +80 -20%, Y5V, ROHS	Murata	GRM39Y5V104Z025
1	C2	CAP, SMD, 0603, 0.22 $\mu$ F, 50V, 10%, X7R, ROHS	Murata	GCM188R71H224KA64D
4	C14, C17, C25, C26	CAP, SMD, 1210, 2.2 $\mu$ F, 100V, 10%, X7R, ROHS	Murata	GRM32ER72A225KA35L
4	C13, C15, C23, C24	CAP, SMD, 1210, 2.2 $\mu$ F, 50V, 10%, X7R, ROHS	TDK	C3225X7R1H225K
2	C16, C18	CAP, SMD, 8x10.2mm, 220 $\mu$ F, 20%, 25V, 80m $\Omega$ , ALUM.ELEC., ROHS	Panasonic	EEE-FP1E221AP
4	L1	COIL-INDUCTOR, AEC-Q200, SMD, 16.9x16.9, 8.2 $\mu$ H, 20%, 18A, ROHS	Bourns	SRP1770TA-8R2M
2	Q1, Q2	TRANSISTOR-MOS, N-CHANNEL, 8P, PWR56, 80V, 80A, ROHS	Fairchild	FDMS86368_F085
3	R6, R12, R20	RES, SMD, 0603, 0 $\Omega$ , 1/10W, TF, ROHS	Venkel	CR0603-10W-000T
1	R10	RES, SMD, 0603, 10k, 1/10W, 1%, TF, ROHS	Venkel	CR0603-10W-1002FT
2	R15, R17	RES, SMD, 0603, 100k, 1/10W, 1%, TF, ROHS	Venkel	CR0603-10W-1003FT
2	R23, R24	RES, SMD, 0603, 20k, 1/10W, 1%, TF, ROHS	Venkel	CR0603-10W-2002FT
4	R3, R4, R13, R14	RES, SMD, 0805, 3.3 $\Omega$ , 1/8W, 1%, TF, ROHS	Panasonic	ERJ-6RQF3R3V
1	SW1	SWITCH-TOGGLE, SMD, 6PIN, SPDT, 3POS, ON-OFF-ON, ROHS	ITT Industries/ C&K Division	GT13MSCBE
2	J2, J3	CONN-TURRET, TERMINAL POST, TH, ROHS	Keystone	1514-2
2	J9, J13	CONN-BNC, RECEPTACLE, TH, 4 POST, 50 $\Omega$ , SILVERCONTACT, ROHS	Amphenol	31-5329-51RFX
10	TP1-3, TP8, TP11, TP14-TP16, TP18, TP19	CONN-MINI TEST POINT, VERTICAL, WHITE, ROHS	Keystone	5002
5	J1, J4-J6, J10	CONN-HEADER, 1x2, BRKAWY 1x36, 2.54mm, ROHS	Berg/FCI	68000-236HLF
	D1, R5, R16, R19, C1	DNP		

### 3.5 Board Layout

#### 3.5.1 ISL78424EVAL3Z Layout

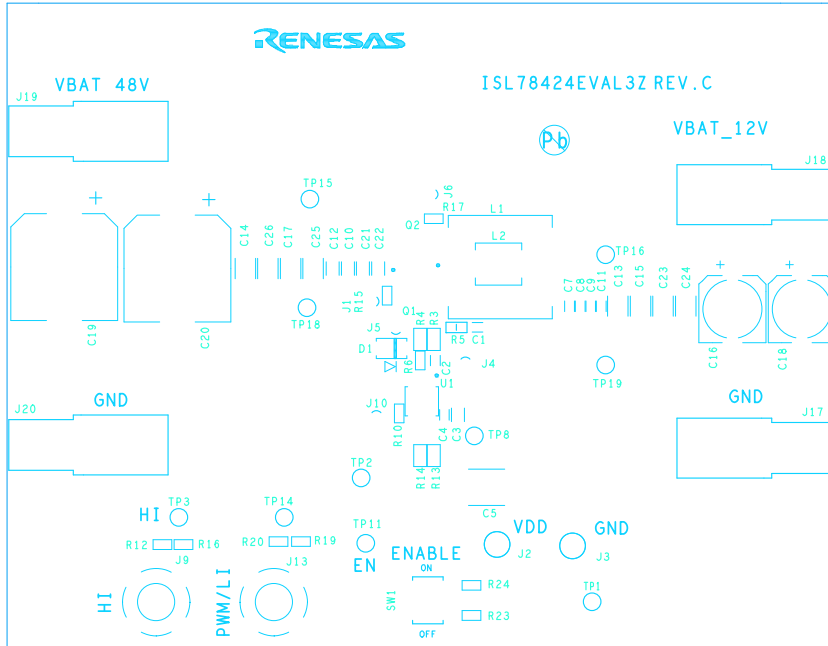

Figure 7. Silkscreen Top Layer

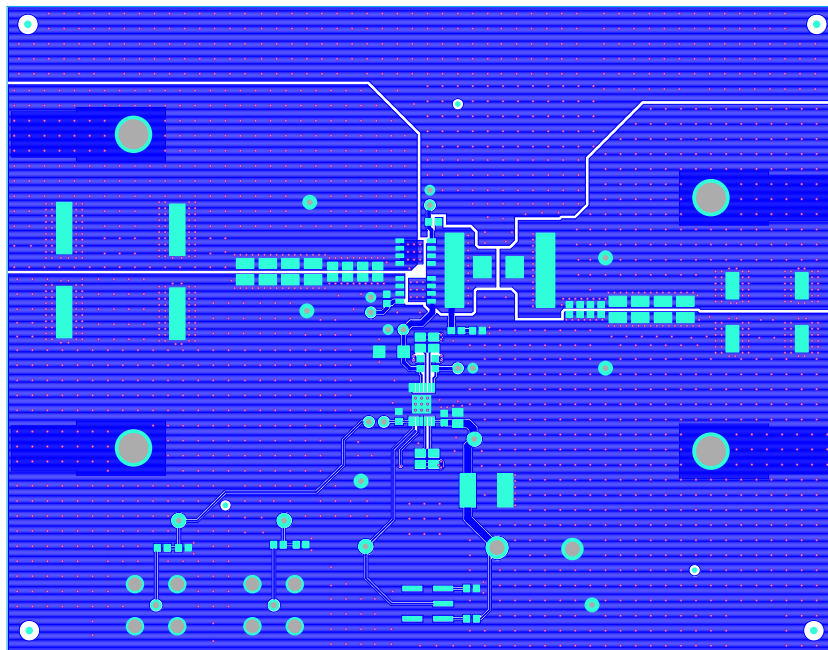

Figure 8. Layer 1

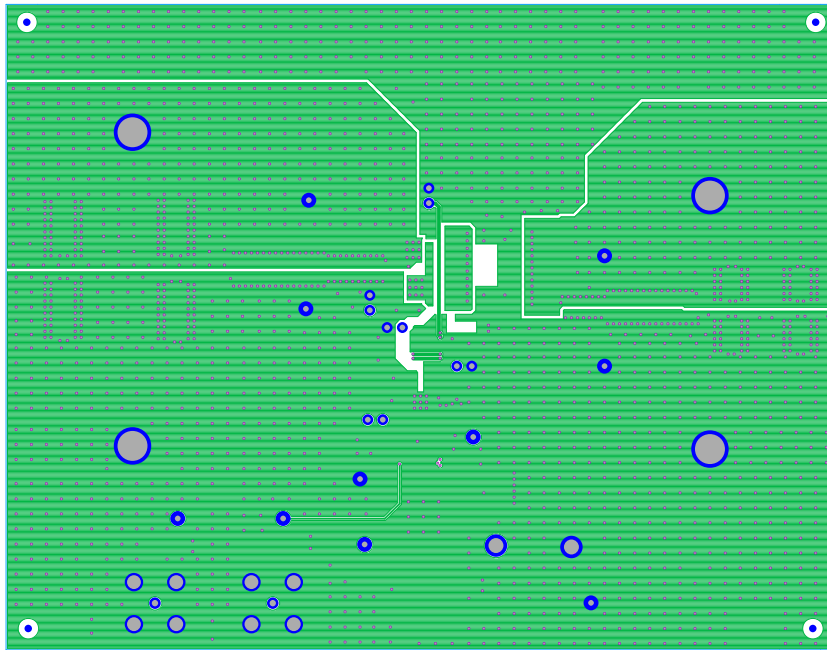

Figure 9. Layer 2

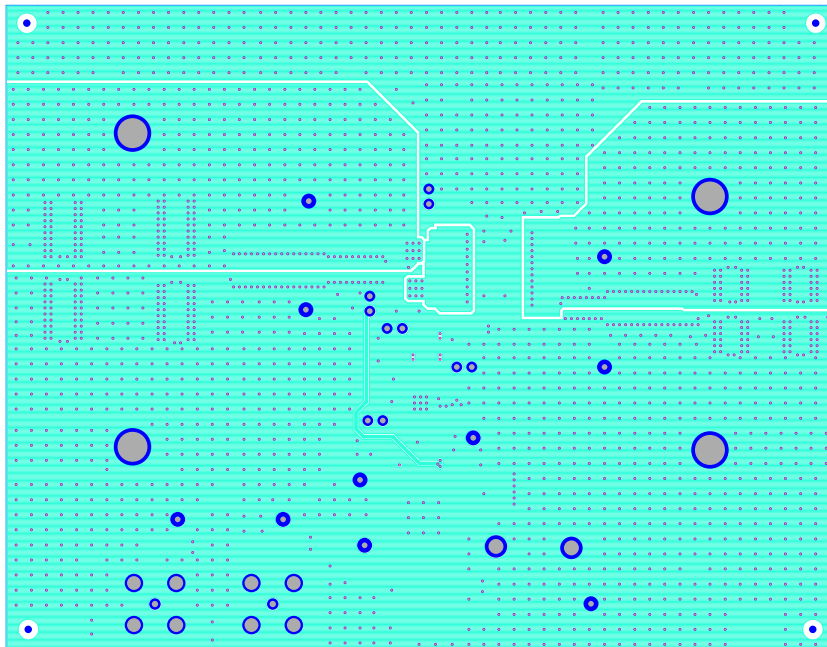

Figure 10. Layer 3

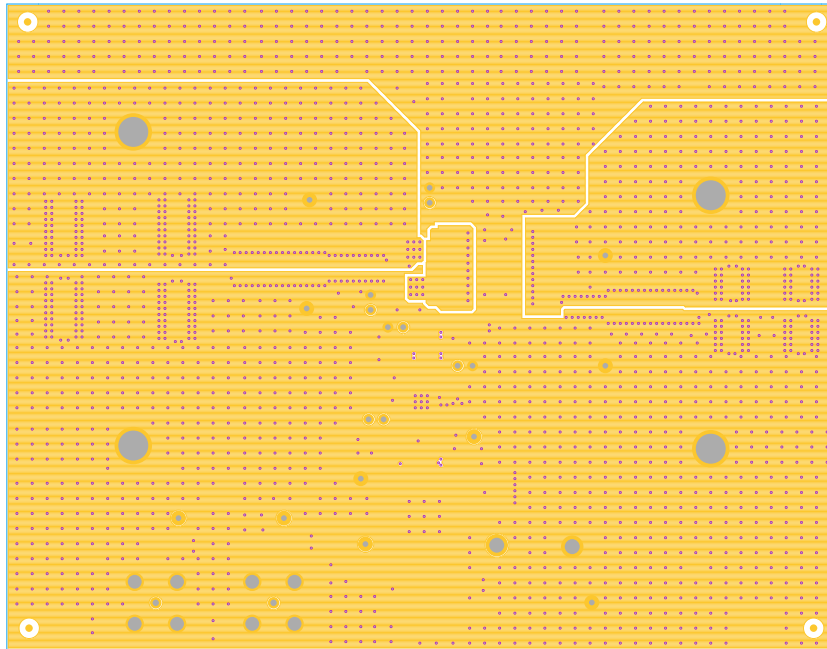

Figure 11. Layer 4

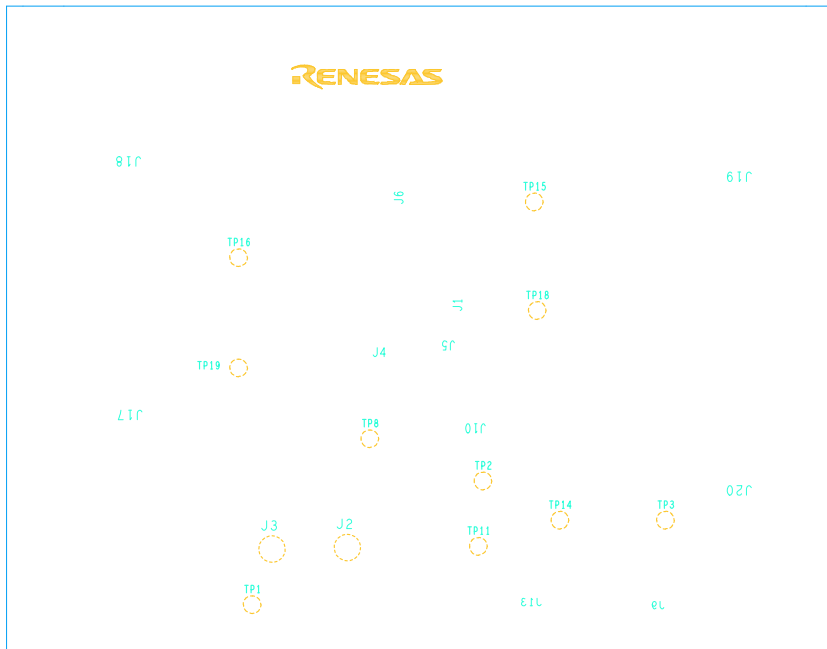

Figure 12. Silkscreen Bottom Layer

### 3.5.2 ISL78434EVAL1Z Layout

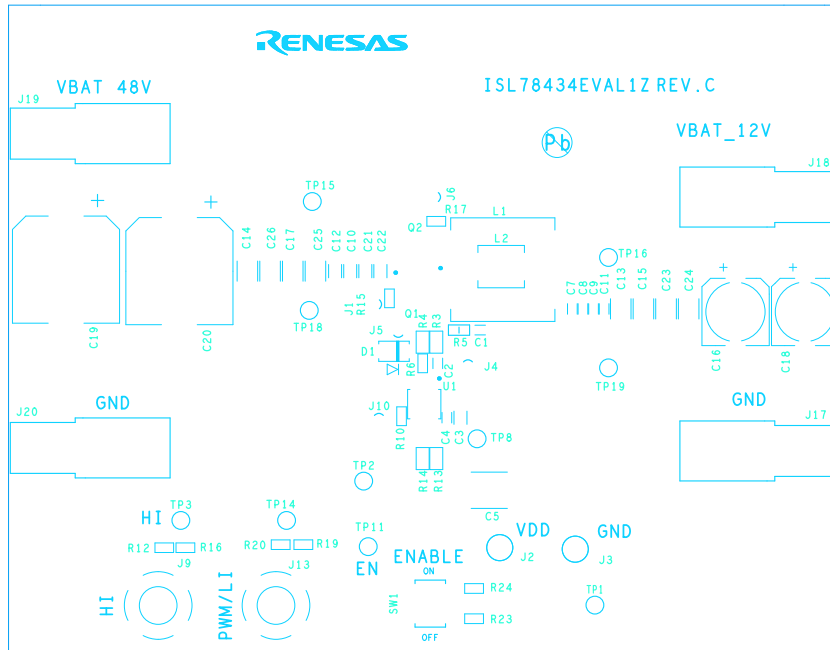

Figure 13. Silkscreen Top Layer

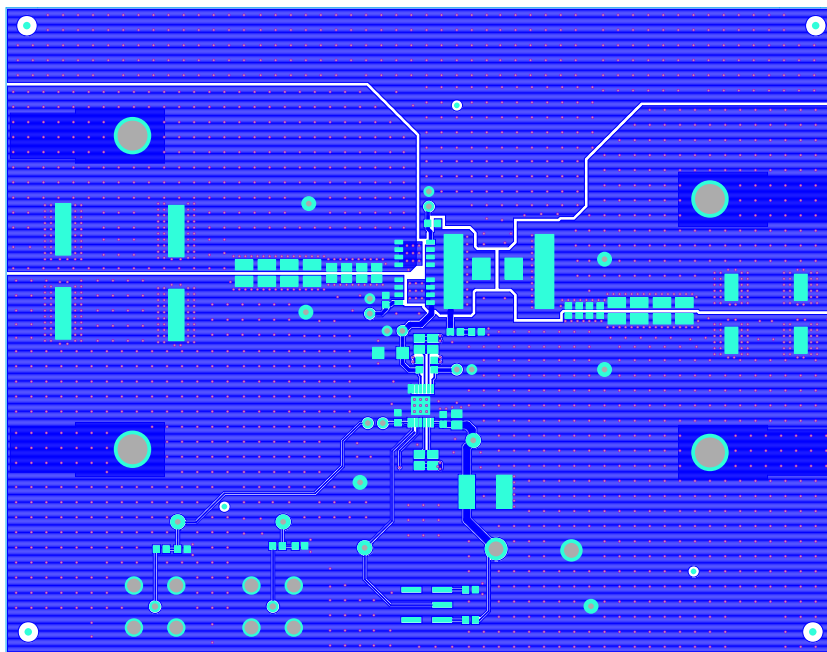

Figure 14. Layer 1

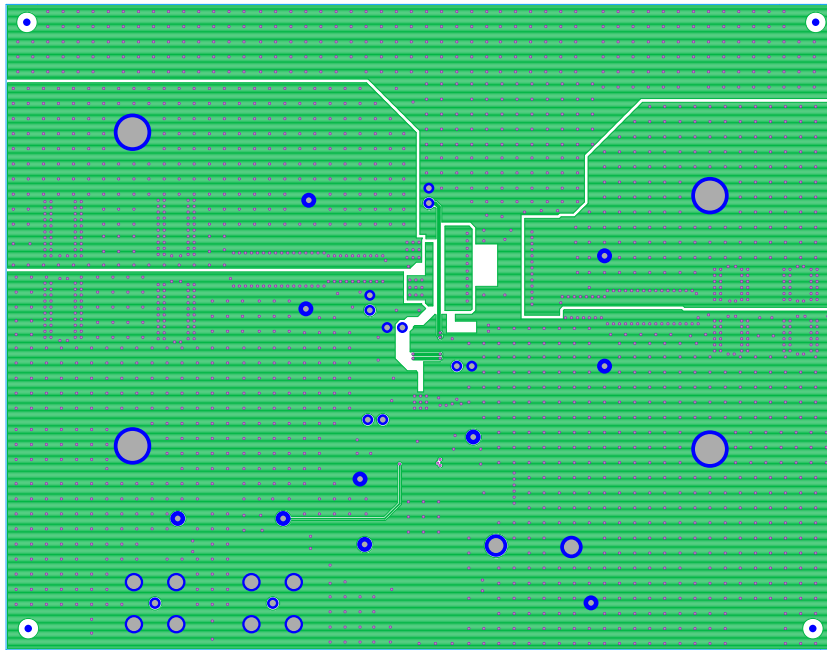

Figure 15. Layer 2

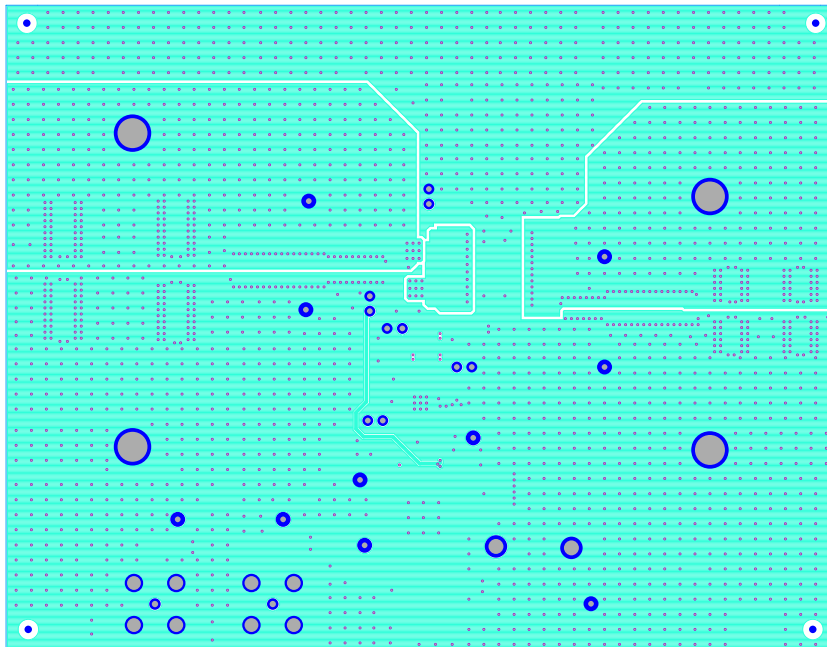

Figure 16. Layer 3

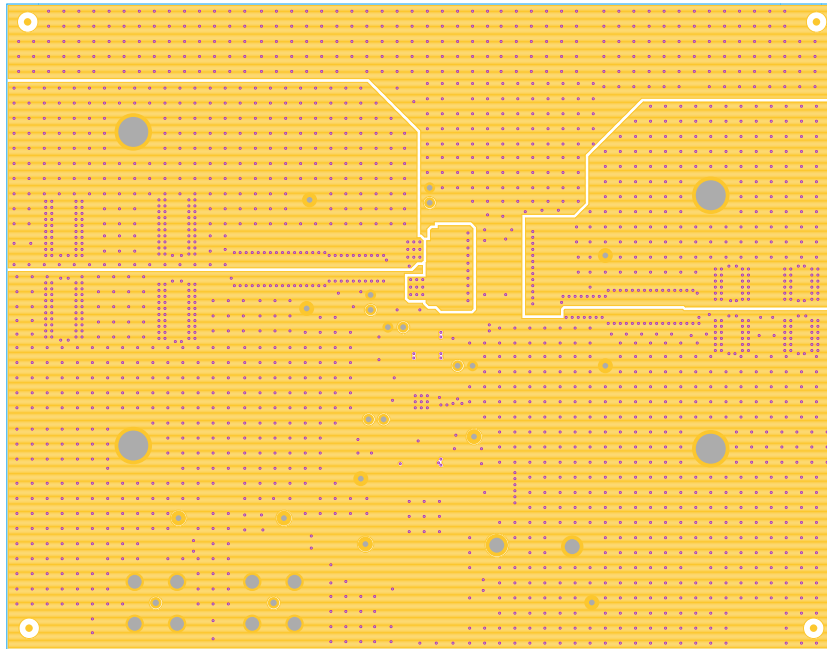

Figure 17. Layer 4

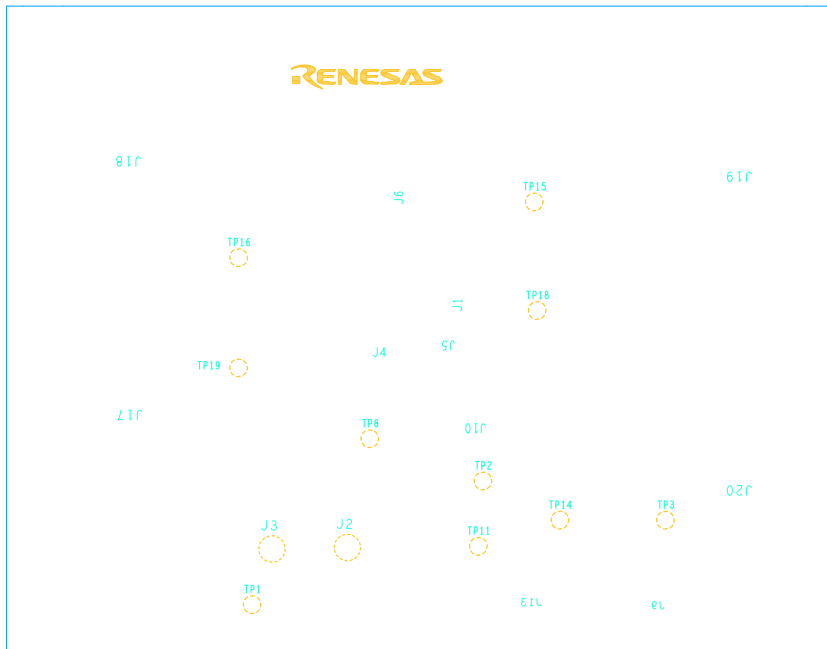

Figure 18. Silkscreen Bottom Layer



### 4. Typical Performance Curves

Unless noted:  $V_{DD} = 12V$ ,  $V_{BRIDGE} = 48V$ , PWM = 100kHz square wave, 0V to 5V, 25% duty cycle,  $T_A = +25^\circ C$

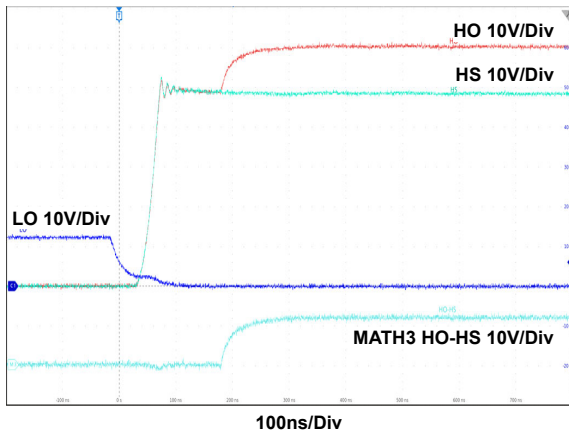

Figure 19. ISL78424EVAL3Z Dead Time LO Falling to HO Rising

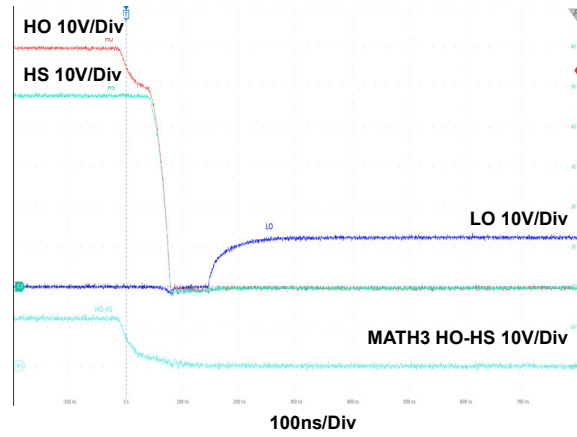

Figure 20. ISL78424EVAL3Z Dead Time HO Falling to LO Rising

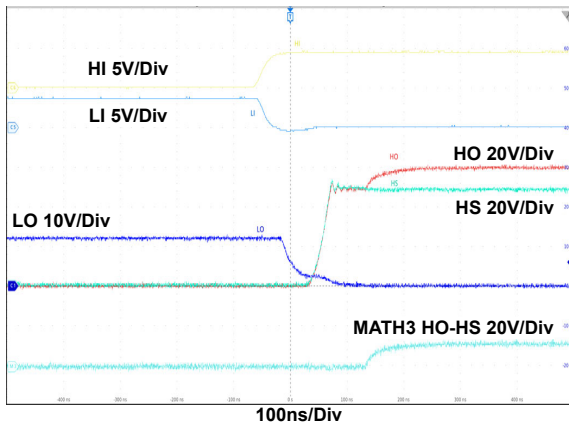

Figure 21. ISL78434EVAL1Z Dead Time LO Falling to HO Rising

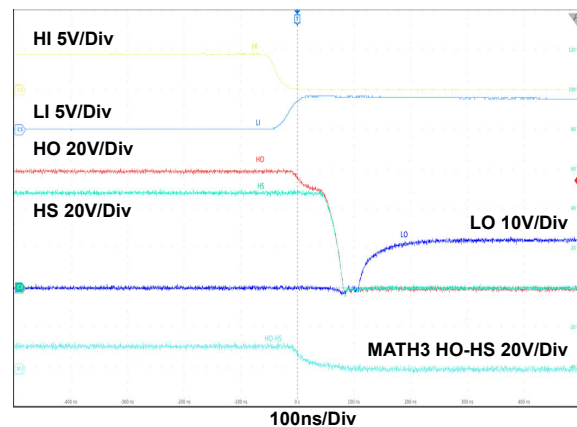

Figure 22. ISL78434EVAL1Z Dead Time HO Falling to LO Rising

## 5. Revision History

Rev.	Date	Description
01.00	Oct 23, 2018	Initial release

## Notice

1. Descriptions of circuits, software and other related information in this document are provided only to illustrate the operation of semiconductor products and application examples. You are fully responsible for the incorporation or any other use of the circuits, software, and information in the design of your product or system. Renesas Electronics disclaims any and all liability for any losses and damages incurred by you or third parties arising from the use of these circuits, software, or information.
2. Renesas Electronics hereby expressly disclaims any warranties against and liability for infringement or any other claims involving patents, copyrights, or other intellectual property rights of third parties, by or arising from the use of Renesas Electronics products or technical information described in this document, including but not limited to, the product data, drawings, charts, programs, algorithms, and application examples.
3. No license, express, implied or otherwise, is granted hereby under any patents, copyrights or other intellectual property rights of Renesas Electronics or others.
4. You shall not alter, modify, copy, or reverse engineer any Renesas Electronics product, whether in whole or in part. Renesas Electronics disclaims any and all liability for any losses or damages incurred by you or third parties arising from such alteration, modification, copying or reverse engineering.
5. Renesas Electronics products are classified according to the following two quality grades: "Standard" and "High Quality". The intended applications for each Renesas Electronics product depends on the product's quality grade, as indicated below.  
"Standard": Computers; office equipment; communications equipment; test and measurement equipment; audio and visual equipment; home electronic appliances; machine tools; personal electronic equipment; industrial robots; etc.  
"High Quality": Transportation equipment (automobiles, trains, ships, etc.); traffic control (traffic lights); large-scale communication equipment; key financial terminal systems; safety control equipment; etc.  
Unless expressly designated as a high reliability product or a product for harsh environments in a Renesas Electronics data sheet or other Renesas Electronics document, Renesas Electronics products are not intended or authorized for use in products or systems that may pose a direct threat to human life or bodily injury (artificial life support devices or systems; surgical implantations; etc.), or may cause serious property damage (space system; undersea repeaters; nuclear power control systems; aircraft control systems; key plant systems; military equipment; etc.). Renesas Electronics disclaims any and all liability for any damages or losses incurred by you or any third parties arising from the use of any Renesas Electronics product that is inconsistent with any Renesas Electronics data sheet, user's manual or other Renesas Electronics document.
6. When using Renesas Electronics products, refer to the latest product information (data sheets, user's manuals, application notes, "General Notes for Handling and Using Semiconductor Devices" in the reliability handbook, etc.), and ensure that usage conditions are within the ranges specified by Renesas Electronics with respect to maximum ratings, operating power supply voltage range, heat dissipation characteristics, installation, etc. Renesas Electronics disclaims any and all liability for any malfunctions, failure or accident arising out of the use of Renesas Electronics products outside of such specified ranges.
7. Although Renesas Electronics endeavors to improve the quality and reliability of Renesas Electronics products, semiconductor products have specific characteristics, such as the occurrence of failure at a certain rate and malfunctions under certain use conditions. Unless designated as a high reliability product or a product for harsh environments in a Renesas Electronics data sheet or other Renesas Electronics document, Renesas Electronics products are not subject to radiation resistance design. You are responsible for implementing safety measures to guard against the possibility of bodily injury, injury or damage caused by fire, and/or danger to the public in the event of a failure or malfunction of Renesas Electronics products, such as safety design for hardware and software, including but not limited to redundancy, fire control and malfunction prevention, appropriate treatment for aging degradation or any other appropriate measures. Because the evaluation of microcomputer software alone is very difficult and impractical, you are responsible for evaluating the safety of the final products or systems manufactured by you.
8. Please contact a Renesas Electronics sales office for details as to environmental matters such as the environmental compatibility of each Renesas Electronics product. You are responsible for carefully and sufficiently investigating applicable laws and regulations that regulate the inclusion or use of controlled substances, including without limitation, the EU RoHS Directive, and using Renesas Electronics products in compliance with all these applicable laws and regulations. Renesas Electronics disclaims any and all liability for damages or losses occurring as a result of your noncompliance with applicable laws and regulations.
9. Renesas Electronics products and technologies shall not be used for or incorporated into any products or systems whose manufacture, use, or sale is prohibited under any applicable domestic or foreign laws or regulations. You shall comply with any applicable export control laws and regulations promulgated and administered by the governments of any countries asserting jurisdiction over the parties or transactions.
10. It is the responsibility of the buyer or distributor of Renesas Electronics products, or any other party who distributes, disposes of, or otherwise sells or transfers the product to a third party, to notify such third party in advance of the contents and conditions set forth in this document.
11. This document shall not be reprinted, reproduced or duplicated in any form, in whole or in part, without prior written consent of Renesas Electronics.
12. Please contact a Renesas Electronics sales office if you have any questions regarding the information contained in this document or Renesas Electronics products.

(Note 1) "Renesas Electronics" as used in this document means Renesas Electronics Corporation and also includes its directly or indirectly controlled subsidiaries.

(Note 2) "Renesas Electronics product(s)" means any product developed or manufactured by or for Renesas Electronics.

(Rev.4.0-1 November 2017)



### SALES OFFICES

Renesas Electronics Corporation

<http://www.renesas.com>

Refer to "<http://www.renesas.com/>" for the latest and detailed information.

#### Renesas Electronics Corporation

TOYOSU FORESIA, 3-2-24 Toyosu, Koto-ku, Tokyo 135-0061, Japan

#### Renesas Electronics America Inc.

1001 Murphy Ranch Road, Milpitas, CA 95035, U.S.A.  
Tel: +1-408-432-8888, Fax: +1-408-434-5351

#### Renesas Electronics Canada Limited

9251 Yonge Street, Suite 8309 Richmond Hill, Ontario Canada L4C 9T3  
Tel: +1-905-237-2004

#### Renesas Electronics Europe Limited

Dukes Meadow, Millboard Road, Bourne End, Buckinghamshire, SL8 5FH, U.K  
Tel: +44-1628-651-700

#### Renesas Electronics Europe GmbH

Arcadiastrasse 10, 40472 Düsseldorf, Germany  
Tel: +49-211-6503-0, Fax: +49-211-6503-1327

#### Renesas Electronics (China) Co., Ltd.

Room 1709 Quantum Plaza, No.27 ZhichunLu, Haidian District, Beijing, 100191 P. R. China  
Tel: +86-10-8235-1155, Fax: +86-10-8235-7679

#### Renesas Electronics (Shanghai) Co., Ltd.

Unit 301, Tower A, Central Towers, 555 Langao Road, Putuo District, Shanghai, 200333 P. R. China  
Tel: +86-21-2226-0888, Fax: +86-21-2226-0999

#### Renesas Electronics Hong Kong Limited

Unit 1601-1611, 16/F., Tower 2, Grand Century Place, 193 Prince Edward Road West, Mongkok, Kowloon, Hong Kong  
Tel: +852-2265-6688, Fax: +852 2886-9022

#### Renesas Electronics Taiwan Co., Ltd.

13F, No. 363, Fu Shing North Road, Taipei 10543, Taiwan  
Tel: +886-2-8175-9600, Fax: +886 2-8175-9670

#### Renesas Electronics Singapore Pte. Ltd.

80 Bendemeer Road, Unit #06-02 Hyflux Innovation Centre, Singapore 339949  
Tel: +65-6213-0200, Fax: +65-6213-0300

#### Renesas Electronics Malaysia Sdn.Bhd.

Unit 1207, Block B, Menara Amcorp, Amcorp Trade Centre, No. 18, Jln Persiaran Barat, 46050 Petaling Jaya, Selangor Darul Ehsan, Malaysia  
Tel: +60-3-7955-9390, Fax: +60-3-7955-9510

#### Renesas Electronics India Pvt. Ltd.

No.777C, 100 Feet Road, HAL 2nd Stage, Indiranagar, Bangalore 560 038, India  
Tel: +91-80-67208700, Fax: +91-80-67208777

#### Renesas Electronics Korea Co., Ltd.

17F, KAMCO Yangjae Tower, 262, Gangnam-daero, Gangnam-gu, Seoul, 06265 Korea  
Tel: +82-2-558-3737, Fax: +82-2-558-5338

ISL78424EVAL3Z,  
ISL78434EVAL1Z

**RENESAS**

Компания «Океан Электроники» предлагает заключение долгосрочных отношений при поставках импортных электронных компонентов на взаимовыгодных условиях!

Наши преимущества:

- Поставка оригинальных импортных электронных компонентов напрямую с производств Америки, Европы и Азии, а так же с крупнейших складов мира;
- Широкая линейка поставок активных и пассивных импортных электронных компонентов (более 30 млн. наименований);
- Поставка сложных, дефицитных, либо снятых с производства позиций;
- Оперативные сроки поставки под заказ (от 5 рабочих дней);
- Экспресс доставка в любую точку России;
- Помощь Конструкторского Отдела и консультации квалифицированных инженеров;
- Техническая поддержка проекта, помощь в подборе аналогов, поставка прототипов;
- Поставка электронных компонентов под контролем ВП;
- Система менеджмента качества сертифицирована по Международному стандарту ISO 9001;
- При необходимости вся продукция военного и аэрокосмического назначения проходит испытания и сертификацию в лаборатории (по согласованию с заказчиком);
- Поставка специализированных компонентов военного и аэрокосмического уровня качества (Xilinx, Altera, Analog Devices, Intersil, Interpoint, Microsemi, Actel, Aeroflex, Peregrine, VPT, Syfer, Eurofarad, Texas Instruments, MS Kennedy, Miteq, Cobham, E2V, MA-COM, Hittite, Mini-Circuits, General Dynamics и др.);

Компания «Океан Электроники» является официальным дистрибьютором и эксклюзивным представителем в России одного из крупнейших производителей разъемов военного и аэрокосмического назначения «JONHON», а так же официальным дистрибьютором и эксклюзивным представителем в России производителя высокотехнологичных и надежных решений для передачи СВЧ сигналов «FORSTAR».



## JONHON

«JONHON» (основан в 1970 г.)

Разъемы специального, военного и аэрокосмического назначения:

(Применяются в военной, авиационной, аэрокосмической, морской, железнодорожной, горно- и нефтедобывающей отраслях промышленности)

«FORSTAR» (основан в 1998 г.)

ВЧ соединители, коаксиальные кабели, кабельные сборки и микроволновые компоненты:

(Применяются в телекоммуникациях гражданского и специального назначения, в средствах связи, РЛС, а так же военной, авиационной и аэрокосмической отраслях промышленности).



Телефон: 8 (812) 309-75-97 (многоканальный)

Факс: 8 (812) 320-03-32

Электронная почта: [ocean@oceanchips.ru](mailto:ocean@oceanchips.ru)

Web: <http://oceanchips.ru/>

Адрес: 198099, г. Санкт-Петербург, ул. Калинина, д. 2, корп. 4, лит. А