

CMOS LDO Regulators for Automotive

1ch 200mA

CMOS LDO Regulators

BUxxJA2DG-C series

General Description

BUxxJA2DG-C series are high-performance CMOS LDO regulators with output current ability of up to 200mA. The SSOP5 package can contribute to the downsizing of the set. These devices have excellent noise and load response characteristics despite of its low circuit current consumption of 33 μ A. They are most appropriate for various applications such as power supplies for radar modules and camera modules.

Features

- AEC-Q100 qualified^(Note 1)
- High Output Voltage Accuracy: $\pm 2.0\%$
(In all recommended conditions)
- High Ripple Rejection: 68 dB (Typ, 1kHz)
- Compatible with small ceramic capacitor
($C_{in}=C_{out}=0.47\mu F$)
- Low Current Consumption: 33 μ A
- Output Voltage ON/OFF control
- Output Discharge
- Built-in Over Current Protection Circuit (OCP)
- Built-in Thermal Shutdown Circuit (TSD)
- Package SSOP5 is similar to SOT23-5(JEDEC)

(Note1:Grade1)

Applications

- Automotive (Radar modules, Camera modules, etc.)

Key Specifications

- Input Power Supply Voltage Range: 1.7V to 6.0V
- Output Current Range: 0 to 200mA
- Operating Temperature Range: $-40^{\circ}C$ to $+125^{\circ}C$
- Output Voltage Lineup: 1.0V to 3.3V
- Output Voltage Accuracy: $\pm 2.0\%$
- Circuit Current: 33 μ A(Typ)
- Standby Current: 0 μ A (Typ)

Package

SSOP5

W(Typ) x D(Typ) x H(Max)

2.90mm x 2.80mm x 1.25mm



Typical Application Circuit

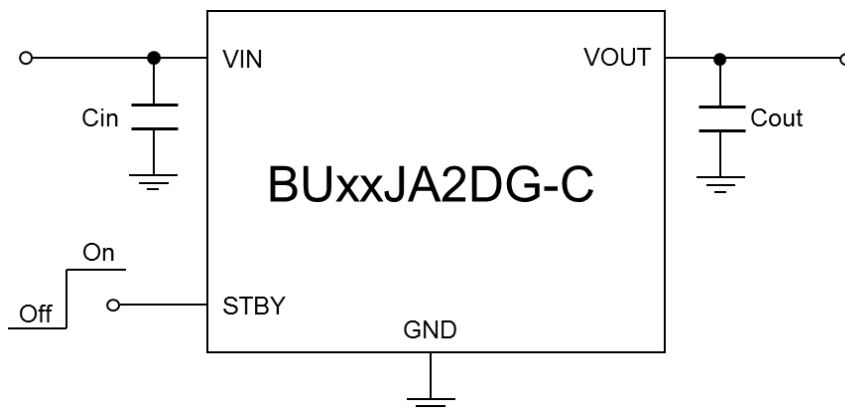

Figure 1. Typical Application Circuit

Ordering Information

B U X X J A 2 D G		-		C T R	
Part Number	Output Voltage 10 : 1.0V 12 : 1.2V 1C : 1.25V 15 : 1.5V 18 : 1.8V 25 : 2.5V 28 : 2.8V 2J : 2.85V 30 : 3.0V 33 : 3.3V	Series name Maximum Output Current : 200mA Maximum Power Supply Voltage Range : 6.5V	Package G : SSOP5	Product Rank C : for Automotive	Packaging and forming specification Embossed tape and reel TR : The pin number 1 is the upper right

Pin Descriptions

Pin No.	Symbol	Function
1	VIN	Input Pin
2	GND	GND Pin
3	STBY	Output Control Pin (High:ON, Low:OFF)
4	N.C.	No Connect
5	VOUT	Output Pin

Pin Configurations

SSOP5(Top view)

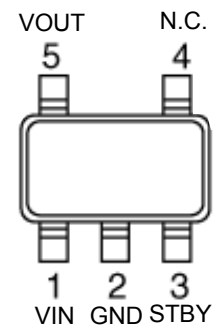

Block Diagram

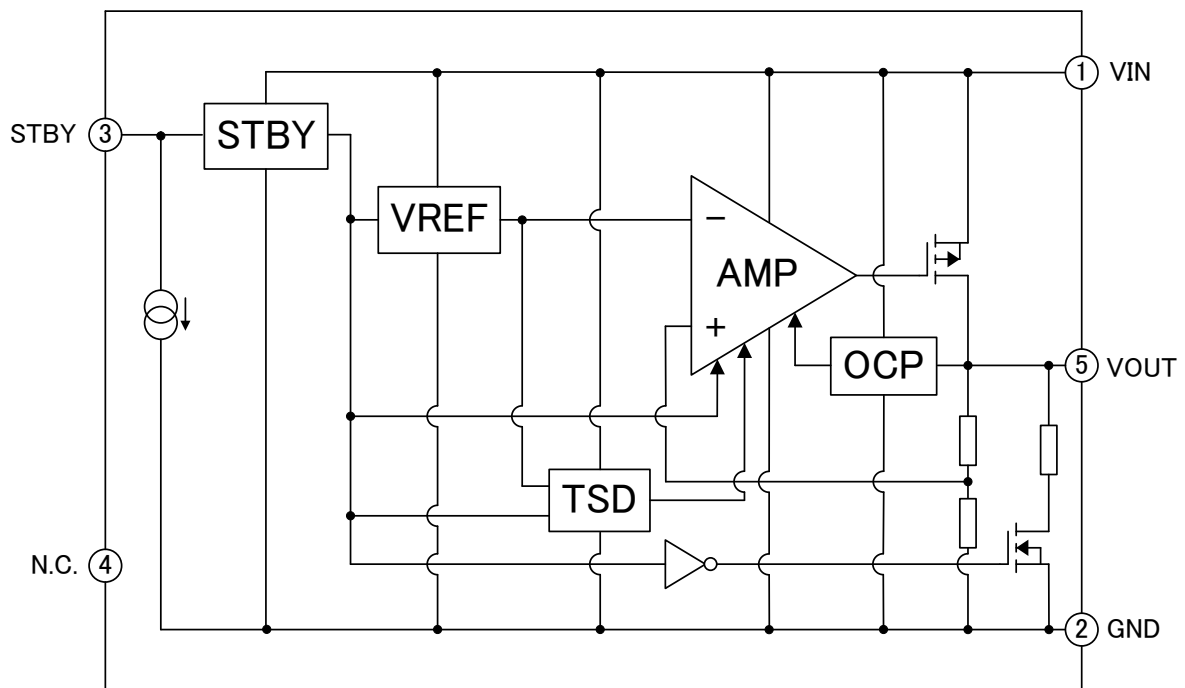

Figure 2. Block diagram

Description of Blocks

Block	Function	Description
STBY	Control Standby mode	STBY controls internal block active and standby state
VREF	Internal Reference Voltage	VREF generates reference voltage.
AMP	Error AMP	AMP amplifies electric signal and drives output power transistor.
OCP	Over Current Protection	When output current exceeds current ability, OCP restricts Output Current.
TSD	Thermal Shutdown	When Junction temperature rise and exceed Maximum junction temperature, TSD turns off Output power transistor.

Absolute Maximum Ratings

Parameter	Symbol	Rating	Unit
Maximum Power Supply Voltage Range	V_{IN}	-0.3 to +6.5 ^(Note1)	V
STBY Voltage	V_{STBY}	-0.3 to +6.5	V
Maximum Junction Temperature	T_{jmax}	+150	°C
Operating Temperature Range	T_{opr}	-40 to +125	°C
Storage Temperature Range	T_{stg}	-55 to +150	°C

(Note1) Not to exceed T_{jmax}

Caution: Operating the IC over the absolute maximum ratings may damage the IC. The damage can either be a short circuit between pins or an open circuit between pins and the internal circuitry. Therefore, it is important to consider circuit protection measures, such as adding a fuse, in case the IC is operated over the absolute maximum ratings.

Recommended Operating Ratings($T_a = -40^{\circ}\text{C}$ to $+125^{\circ}\text{C}$)

Parameter	Symbol	Limit	Unit
Input Power Supply Voltage Range	V_{IN}	1.7 to 6.0	V
STBY voltage	V_{STBY}	1.7 to 6.0	V
Maximum Output Current	I_{OMAX}	0 to 200	mA

Recommended Operating Conditions

Parameter	Symbol	Rating			Unit	Conditions
		Min	Typ	Max		
Input capacitor	C_{in}	0.47 ^(Note1)	1.0	100	μF	A ceramic capacitor is recommended.
Output capacitor	C_{out}	0.47 ^(Note1)	1.0	100	μF	A ceramic capacitor is recommended.

(Note1) Set the value of the capacitor so that it does not fall below the minimum value.

Take into consideration the temperature characteristics, DC device characteristics and degradation with time.

Thermal Resistance (Note 1)

Parameter	Symbol	Thermal Resistance (Typ)		Unit
		1s ^(Note 3)	2s2p ^(Note 4)	
SSOP5				
Junction to Ambient	θ_{JA}	376.5	185.4	°C/W
Junction to Top Characterization Parameter ^(Note 2)	Ψ_{JT}	40	30	°C/W

(Note 1)Based on JESD51-2A(Still-Air).

(Note 2)The thermal characterization parameter to report the difference between junction temperature and the temperature at the top center of the outside surface of the component package.

(Note 3)Using a PCB board based on JESD51-3.

Layer Number of Measurement Board	Material	Board Size
Single	FR-4	114.3mm x 76.2mm x 1.57mmt

Top	
Copper Pattern	Thickness
Footprints and Traces	70μm

(Note 4)Using a PCB board based on JESD51-7.

Layer Number of Measurement Board	Material	Board Size
4 Layers	FR-4	114.3mm x 76.2mm x 1.6mmt

Top		2 Internal Layers		Bottom	
Copper Pattern	Thickness	Copper Pattern	Thickness	Copper Pattern	Thickness
Footprints and Traces	70μm	74.2mm x 74.2mm	35μm	74.2mm x 74.2mm	70μm

Electrical Characteristics

(Unless otherwise noted, $T_a = -40$ to 125°C , $V_{IN} = V_{OUT} + 1.0\text{V}$ ^(Note 1), $V_{STBY} = 1.5\text{V}$, $C_{in} = 1\mu\text{F}$, $C_{out} = 1\mu\text{F}$.)The Typical value is defined at $T_a = 25^\circ\text{C}$

Parameter	Symbol	Limit			Unit	Conditions	
		MIN	TYP	MAX			
Output Voltage	V_{OUT}	$V_{OUT} \times 0.98$	V_{OUT}	$V_{OUT} \times 1.02$	V	$I_{OUT} = 0\text{mA}$ to 200mA $V_{OUT} > 2.5\text{V}$, $V_{IN} = V_{OUT} + 0.5$ to 6.0V $V_{OUT} \leq 2.5\text{V}$, $V_{IN} = 3.0$ to 6.0V	
Line Regulation	V_{DLI}	-	4	15	mV	$I_{OUT} = 10\text{mA}$ $V_{OUT} \leq 2.5\text{V}$, $V_{IN} = 3.0$ to 6.0V	
		-	6	20	mV	$I_{OUT} = 10\text{mA}$ $V_{OUT} > 2.5\text{V}$, $V_{IN} = V_{OUT} + 0.5$ to 6.0V	
Load Regulation1	V_{DLO1}	-	0.5	5	mV	$I_{OUT} = 1\text{mA}$ to 100mA	
Load Regulation2	V_{DLO2}	-	1	10	mV	$I_{OUT} = 1\text{mA}$ to 200mA	
Dropout Voltage	V_{DROP}	-	160	315	mV	$V_{OUT} = 1.8\text{V}$, $I_{OUT} = 100\text{mA}$	
		-	100	190	mV	$V_{OUT} = 2.5\text{V}$, $I_{OUT} = 100\text{mA}$	
		-	85	155	mV	$V_{OUT} \geq 2.8\text{V}$, $I_{OUT} = 100\text{mA}$	
Maximum Output Current	I_{OMAX}	200	-	-	mA	$V_{IN} = V_{OUT} + 1.0\text{V}$ (Note 1)	
Limit Current	I_{LMAX}	250	400	-	mA	applied $V_{OUT} \times 0.98$ for V_{OUT} Pin, $T_a = 25^\circ\text{C}$	
Short Current	I_{SHORT}	-	100	200	mA	$V_{OUT} = 0\text{V}$, $T_a = 25^\circ\text{C}$	
Circuit Current	I_{GND}	-	33	80	μA	$I_{OUT} = 0\text{mA}$	
Circuit Current (STBY)	I_{CCST}	-	-	2.0	μA	$V_{STBY} = 0\text{V}$	
Ripple Rejection Ratio	R.R.	-	68	-	dB	$V_{RR} = -20\text{dBV}$, $f_{RR} = 1\text{kHz}$ $I_{OUT} = 10\text{mA}$, $T_a = 25^\circ\text{C}$	
Load Transient Response	V_{LOT}	-	± 65	-	mV	$I_{OUT} = 1\text{mA}$ to 150mA , $T_{rise} = T_{fall} = 1\mu\text{s}$ $V_{IN} = V_{OUT} + 1.0\text{V}$, $T_a = 25^\circ\text{C}$	
Line Transient Response	V_{LIT}	-	± 5	-	mV	$V_{IN} = V_{OUT} + 0.5$ to $V_{OUT} + 1.0\text{V}$ $T_{rise} = T_{fall} = 10\mu\text{s}$, $T_a = 25^\circ\text{C}$	
Output Noise Voltage	V_{NOIS}	-	30	-	μVrms	Bandwidth 10 to 100kHz , $T_a = 25^\circ\text{C}$	
Startup Time ^(Note 2)	T_{ST}	-	100	300	μs	$T_a = 25^\circ\text{C}$	
Discharge Resistor	R_{DSC}	20	50	80	Ω	$V_{IN} = 4.0\text{V}$, $V_{STBY} = 0\text{V}$, $V_{OUT} = 4.0\text{V}$, $T_a = 25^\circ\text{C}$	
STBY Control Voltage	ON	V_{STBH}	1.1	-	6.0	V	
	OFF	V_{STBL}	0	-	0.5	V	
STBY Pin Current	I_{STBY}	-	-	4.0	μA		

(Note 1) $V_{IN} = 3.0\text{V}$ for $V_{OUT} < 2.5\text{V}$.(Note 2) Startup time = time from EN assertion to $V_{OUT} \times 0.98$

Reference data BU18JA2DG-C (Unless otherwise specified, Ta=25°C)

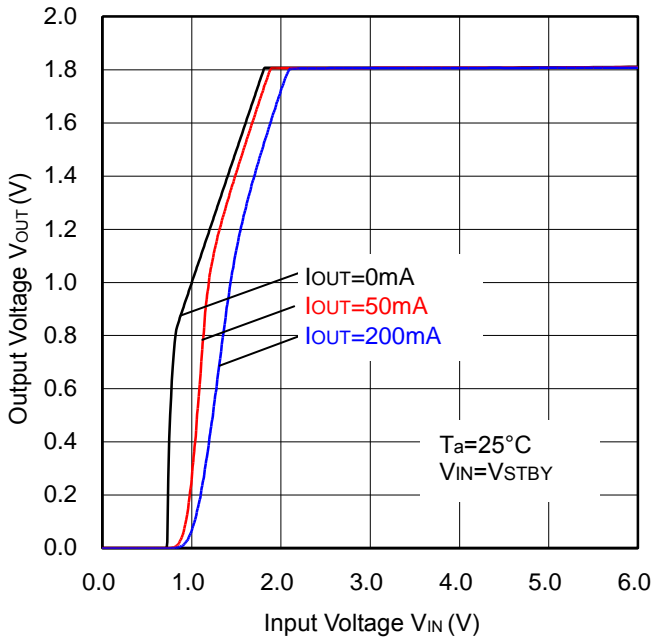

Figure 3. Output Voltage vs. Input Voltage

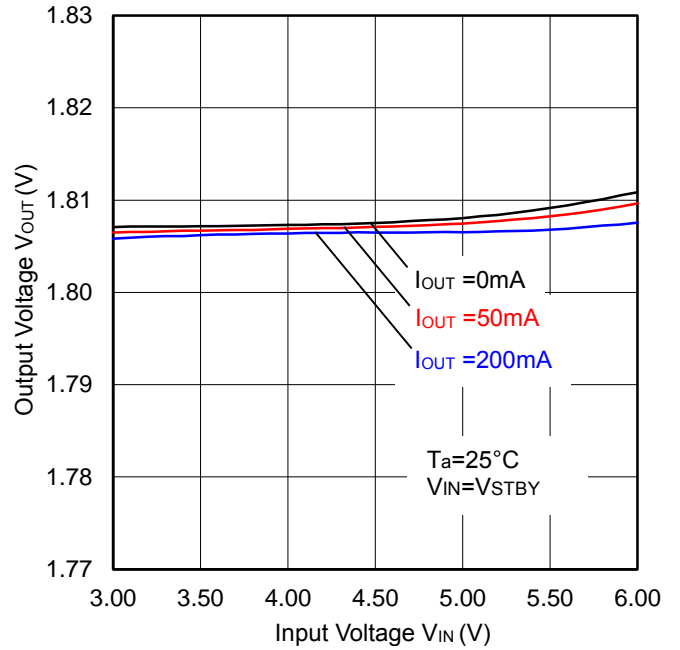

Figure 4. Line Regulation

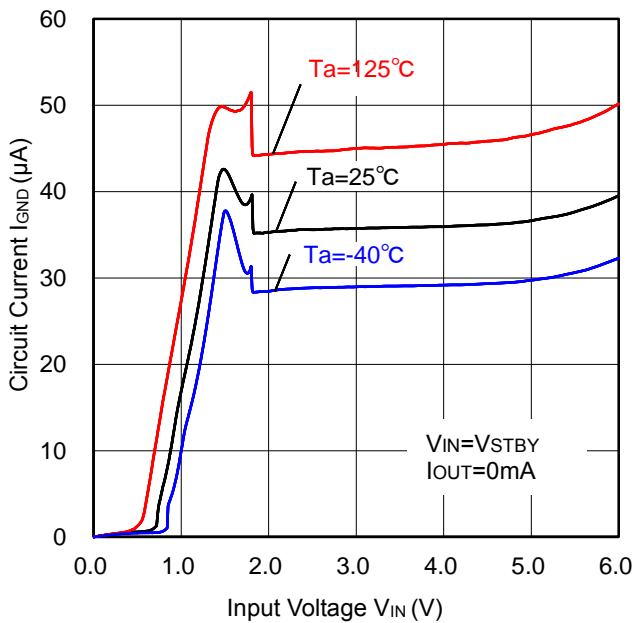

Figure 5. Circuit Current vs. Input Voltage

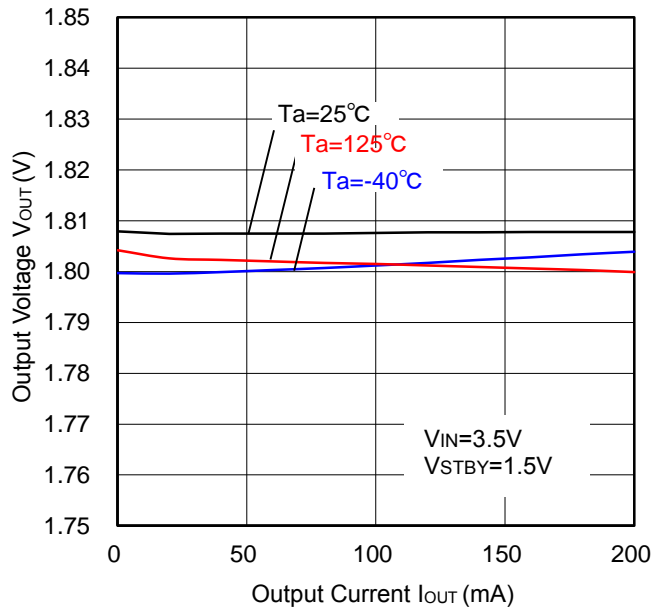

Figure 6. Load Regulation

Reference data BU18JA2DG-C (Unless otherwise specified, Ta=25°C)

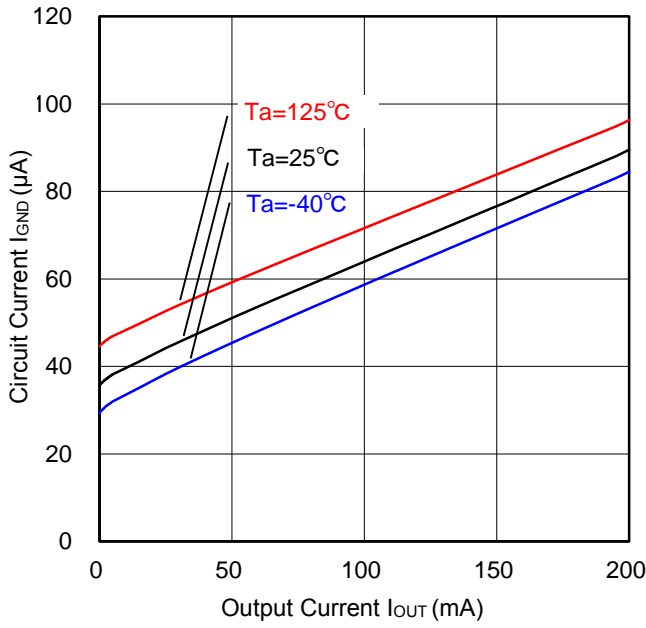

Figure 7. Circuit Current vs. Output Current

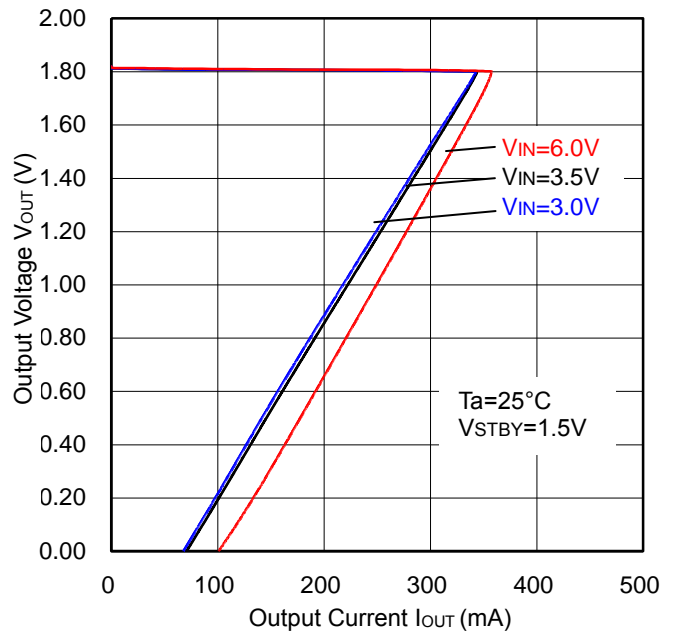

Figure 8. OCP Threshold

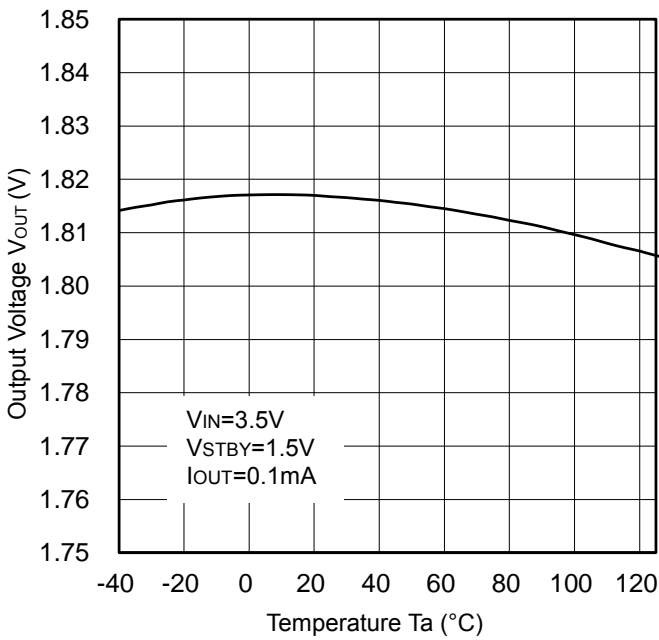

Figure 9. Output Voltage vs. Temperature

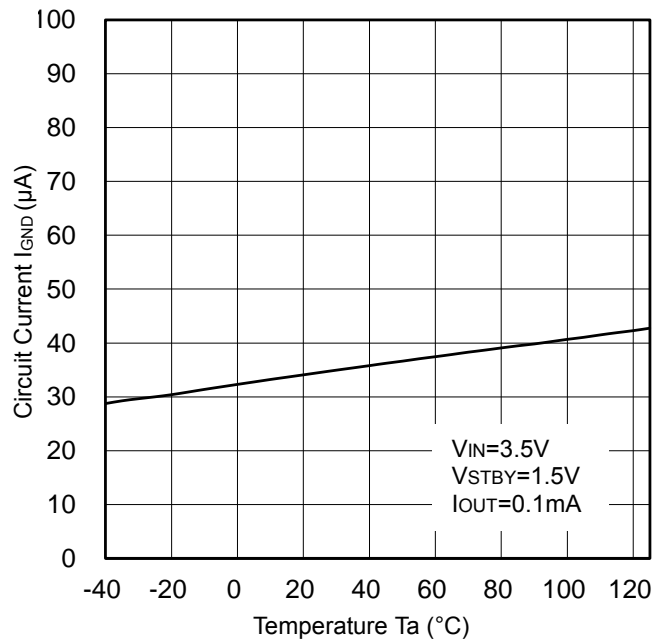

Figure 10. Circuit Current vs. Temperature

Reference data BU18JA2DG-C (Unless otherwise specified, Ta=25°C)

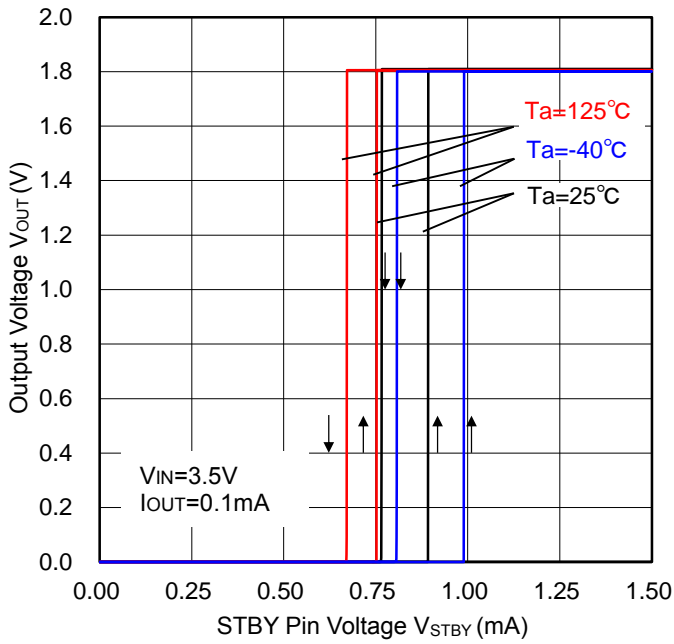

Figure 11. STBY Threshold

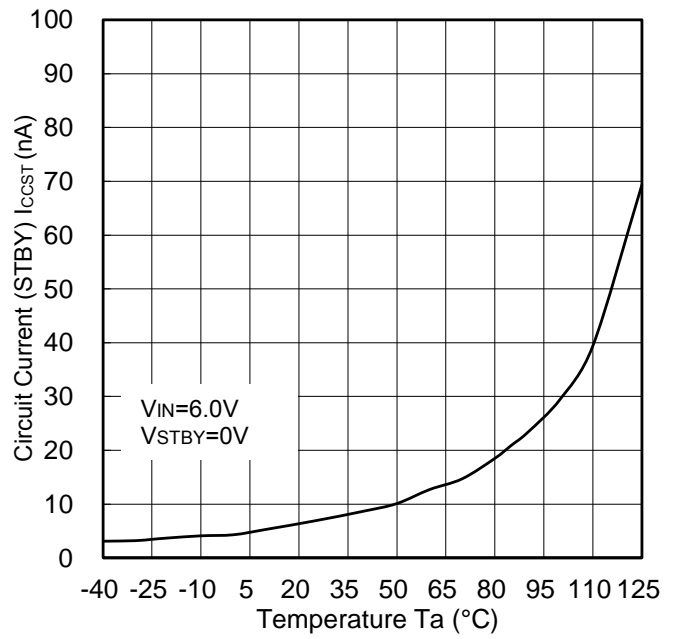

Figure 12. Circuit Current (STBY) vs. Temperature

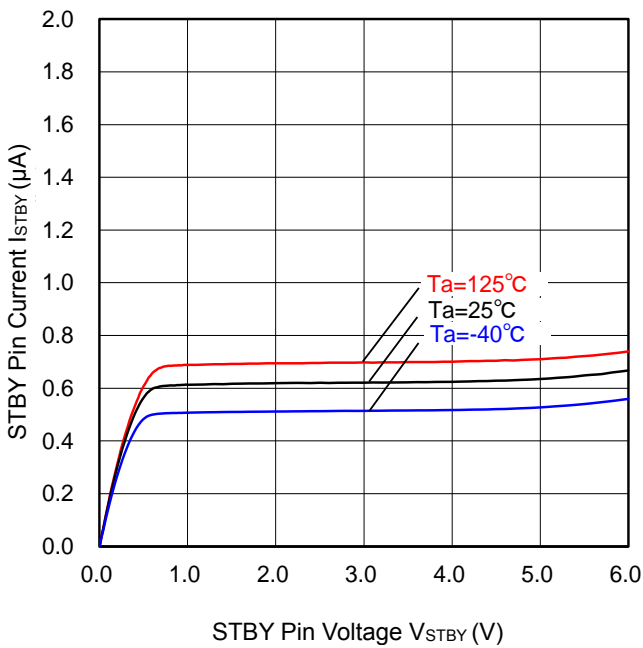

Figure 13. STBY Pin Current vs. STBY Pin Voltage

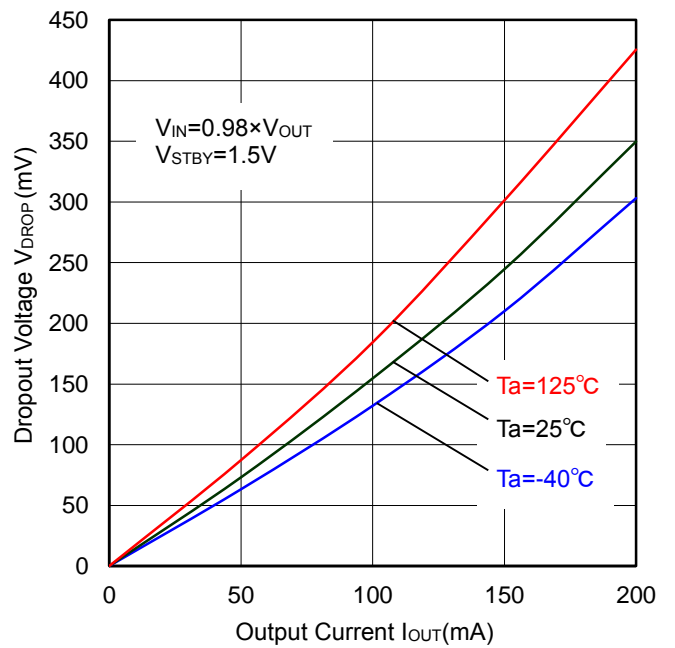

Figure 14. Dropout Voltage vs. Output Current

Reference data BU18JA2DG-C (Unless otherwise specified, Ta=25°C)

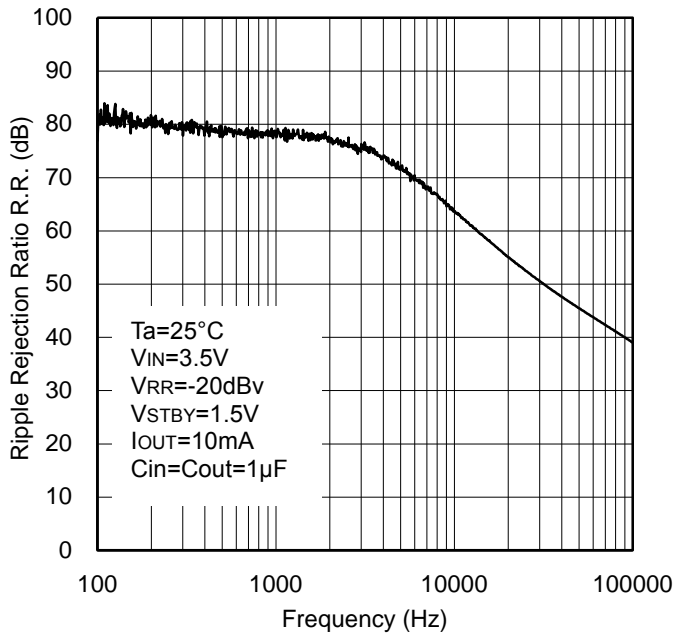

Figure 15. Ripple Rejection Ratio vs. Frequency

Reference data BU18JA2DG-C (Unless otherwise specified, Ta=25°C)

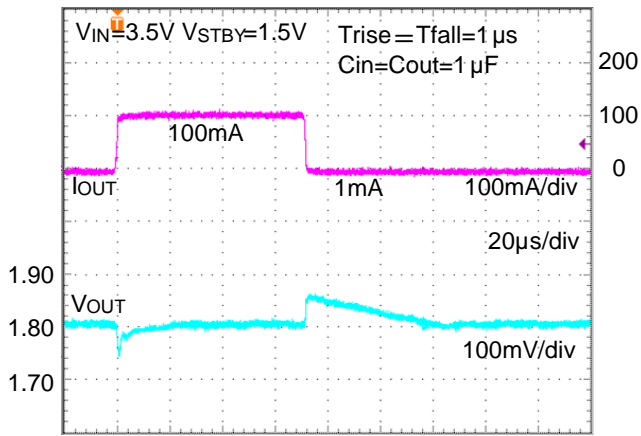

Figure 16. Load Response (1mA to 100mA)

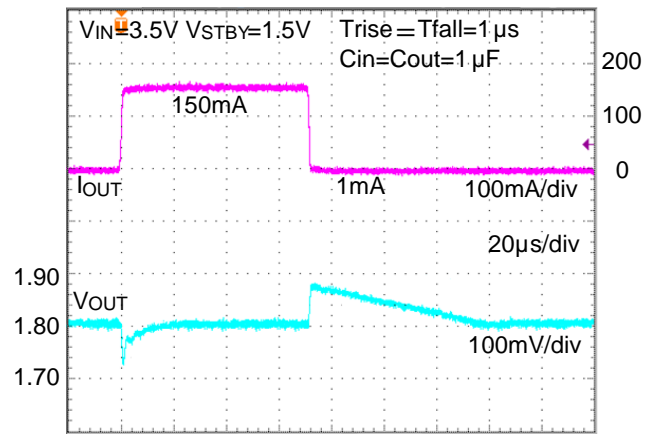

Figure 17. Load Response (1mA to 150mA)

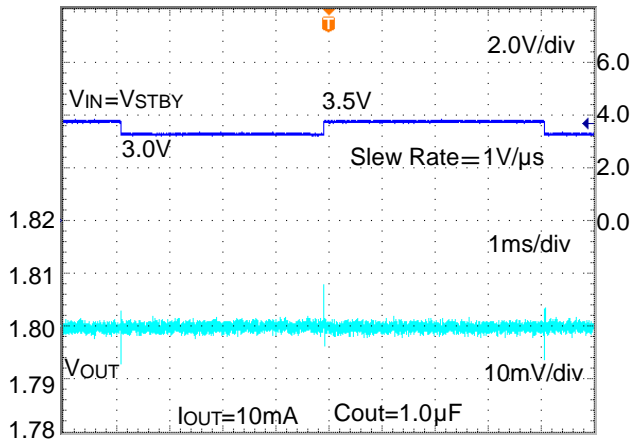

Figure 18. Line Transient Response (3.0 to 3.5V)

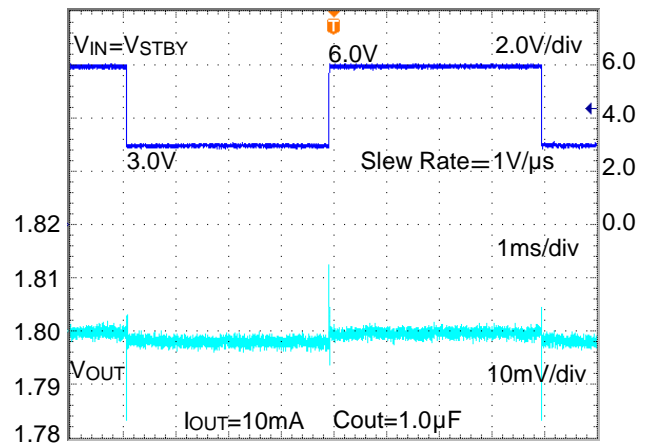

Figure 19. Line Transient Response (3.0V to 6.0V)

Reference data BU18JA2DG-C (Unless otherwise specified, Ta=25°C)

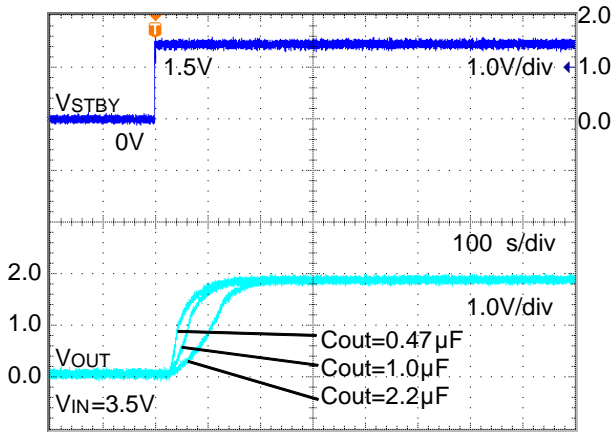

Figure 20. Startup Time (ROUT=open)

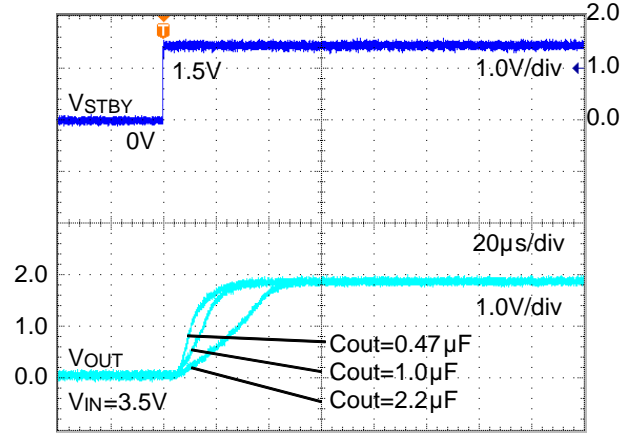

Figure 21. Startup Time (ROUT=9Ω)

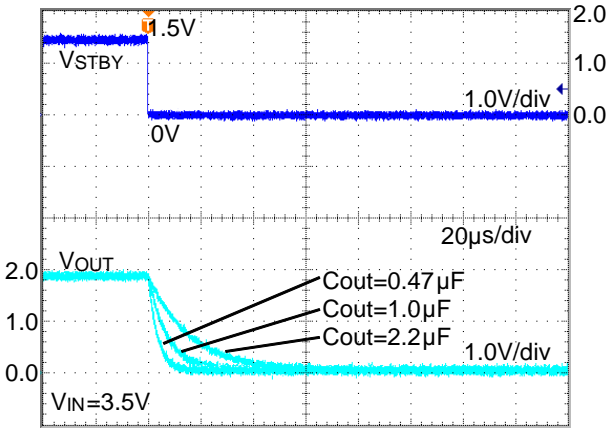

Figure 22. Discharge Time (ROUT=open)

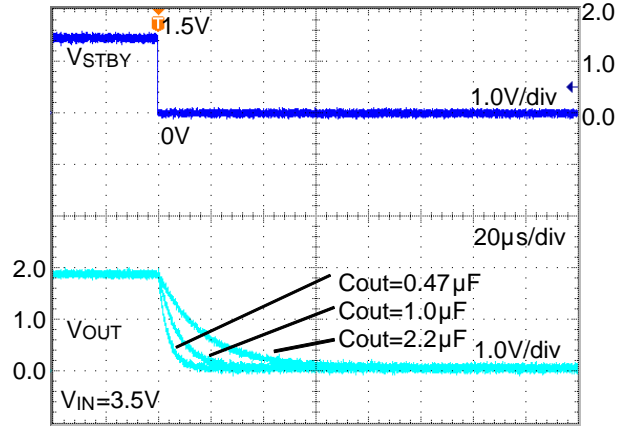

Figure 23. Discharge Time (ROUT=9Ω)

Reference data BU28JA2DG-C (Unless otherwise specified, Ta=25°C)

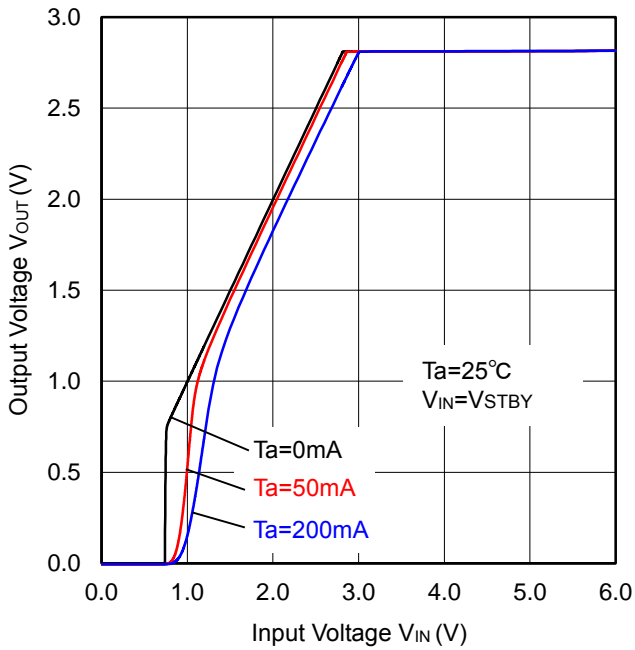

Figure 24. Output Voltage vs. Input Voltage

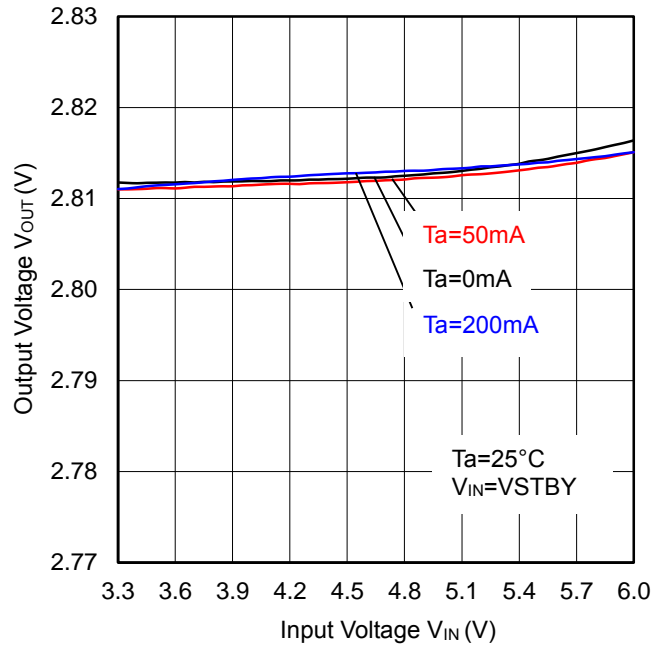

Figure 25. Line Regulation

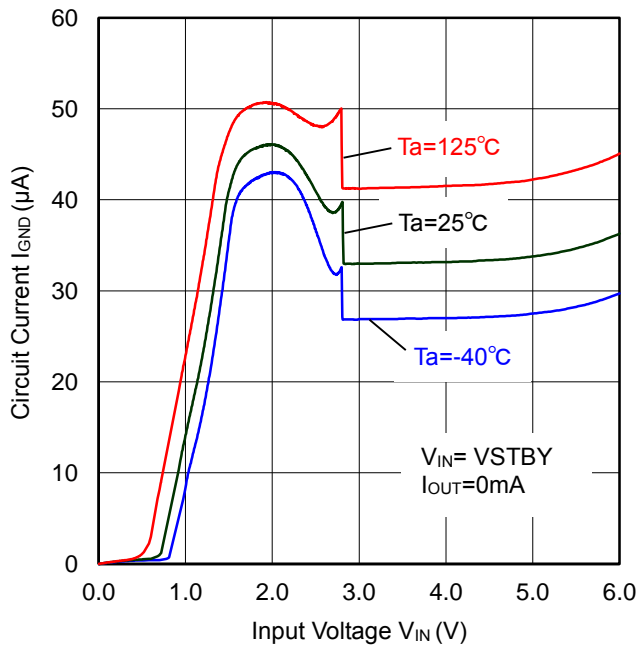

Figure 26. Circuit Current vs. Input Voltage

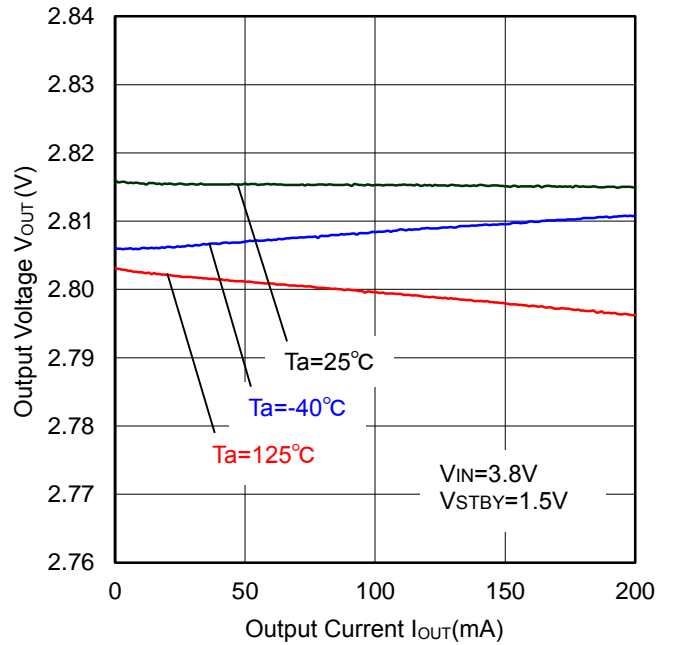

Figure 27. Load Regulation

Reference data BU28JA2DG-C (Unless otherwise specified, Ta=25°C)

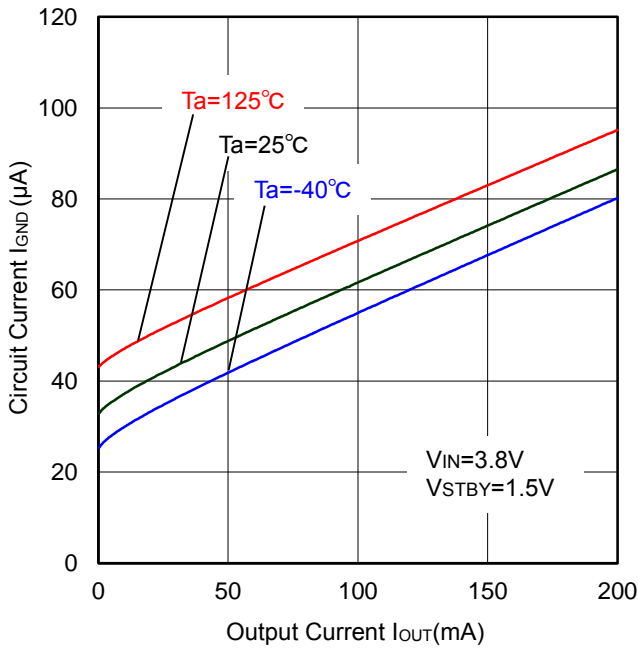

Figure 28. Circuit Current vs. Output Current

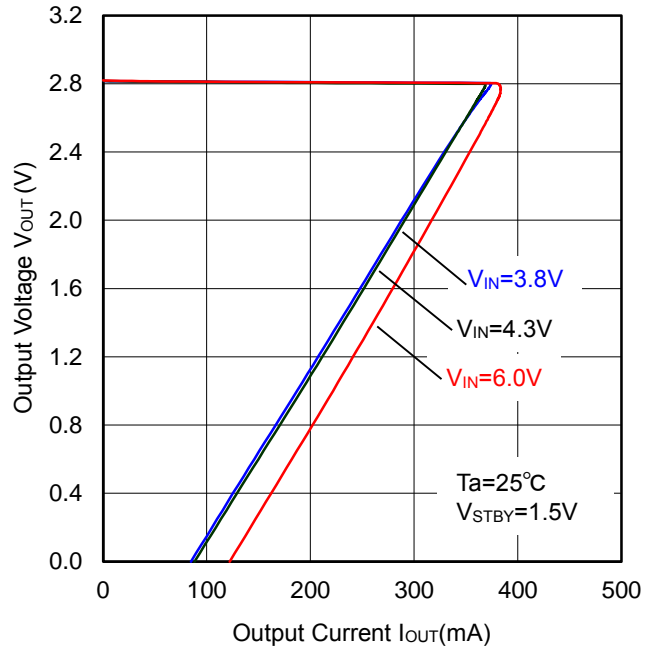

Figure 29. OCP Threshold

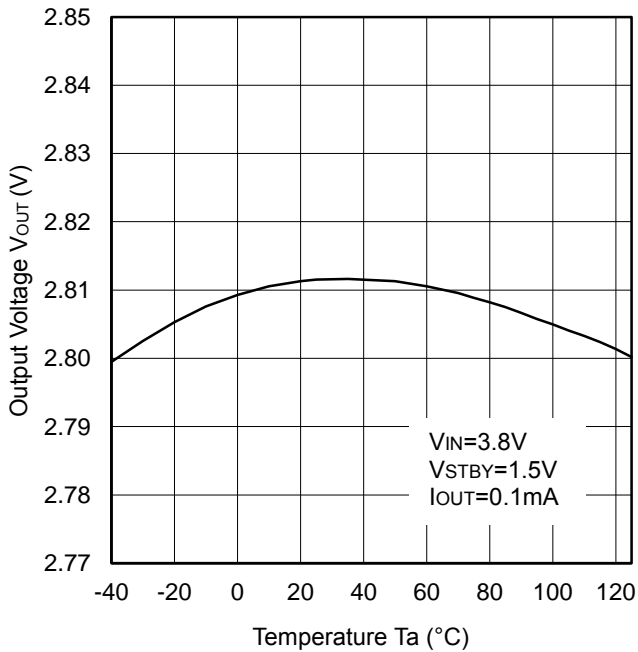

Figure 30. Output Voltage vs. Temperature

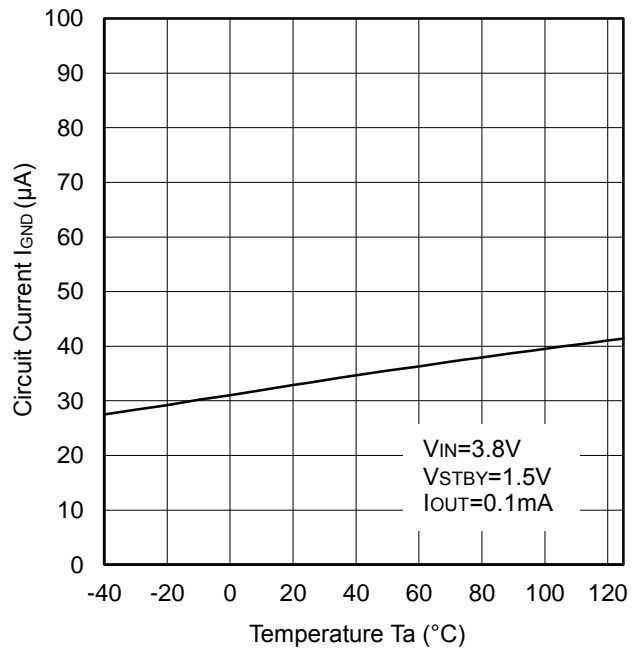

Figure 31. Circuit Current vs. Temperature

Reference data BU28JA2DG-C (Unless otherwise specified, Ta=25°C)

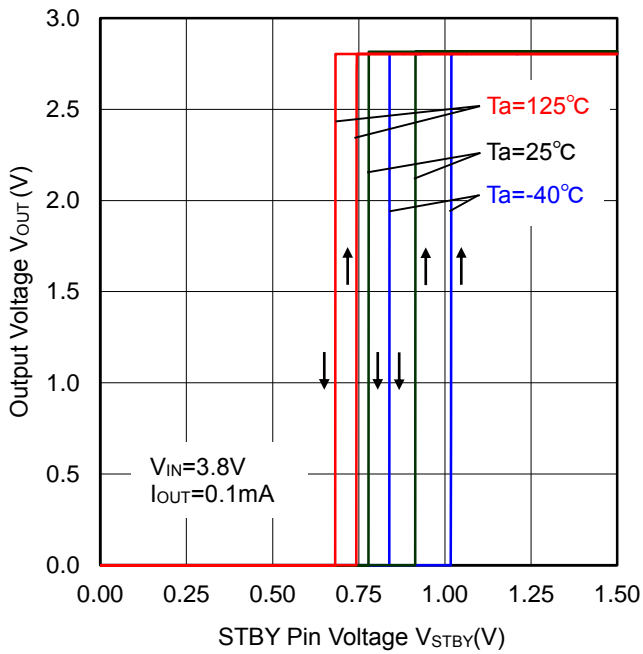

Figure 32. STBY Threshold

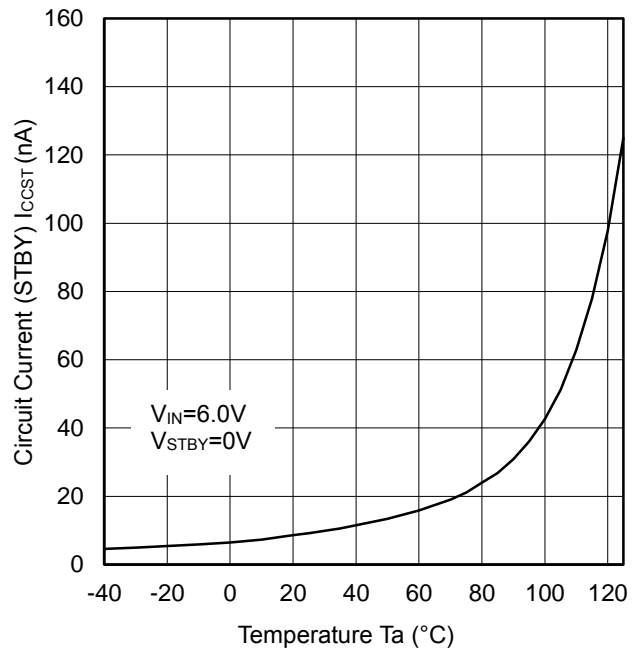

Figure 33. Circuit Current (STBY) vs. Temperature

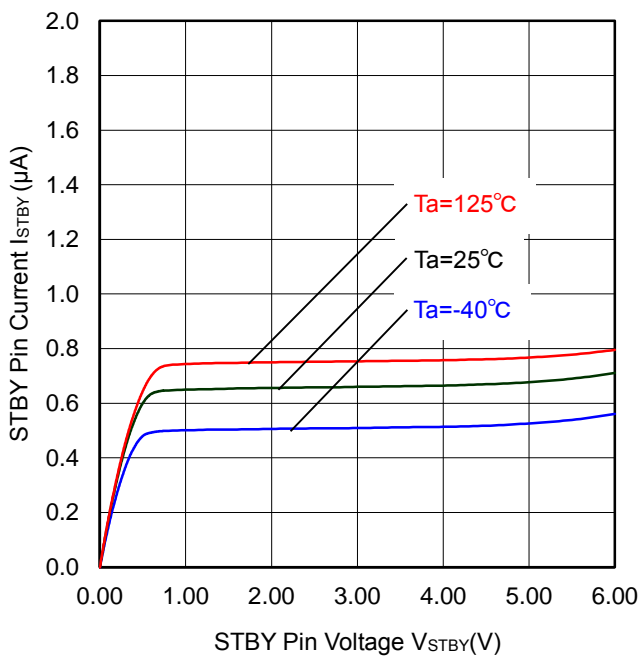

Figure 34. STBY Pin Current vs. STBY Pin Voltage

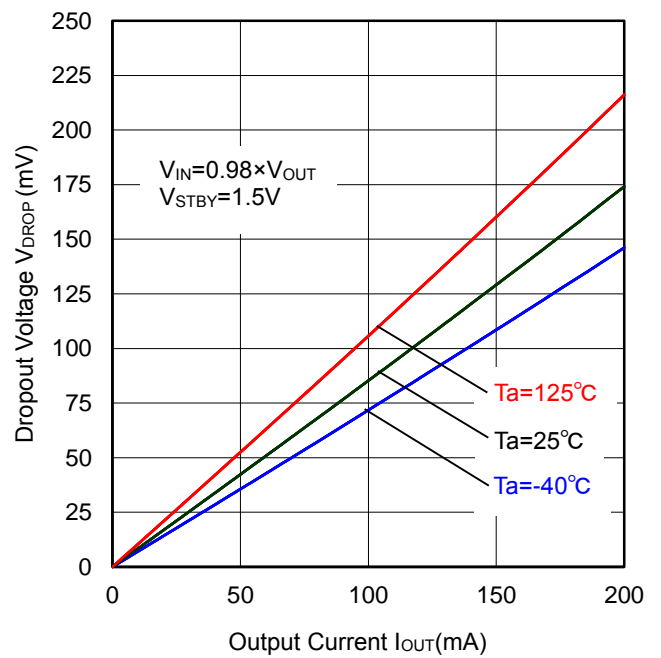

Figure 35. Dropout Voltage vs. Output Current

Reference data BU28JA2DG-C (Unless otherwise specified, Ta=25°C)

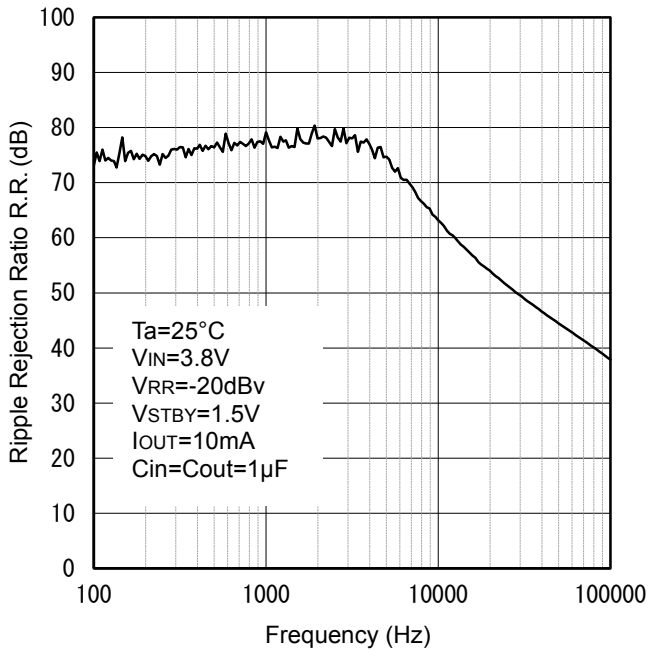

Figure 36. Ripple Rejection Ratio vs. Frequency

Reference data BU28JA2DG-C (Unless otherwise specified, Ta=25°C)

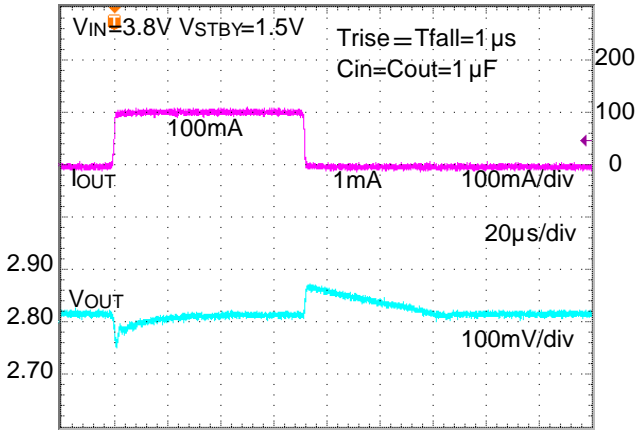

Figure 37. Load Response (1mA to 100mA)

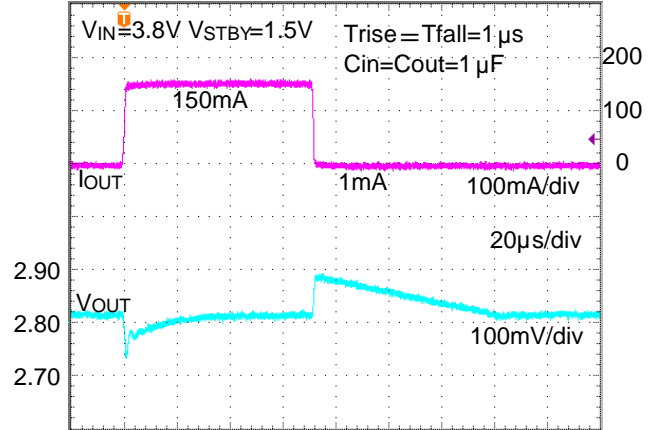

Figure 38. Load Response (1mA to 150mA)

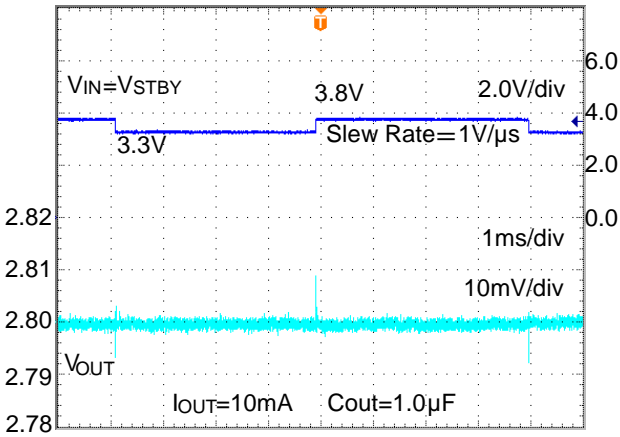

Figure 39. Line Transient Response (3.3V to 3.8V)

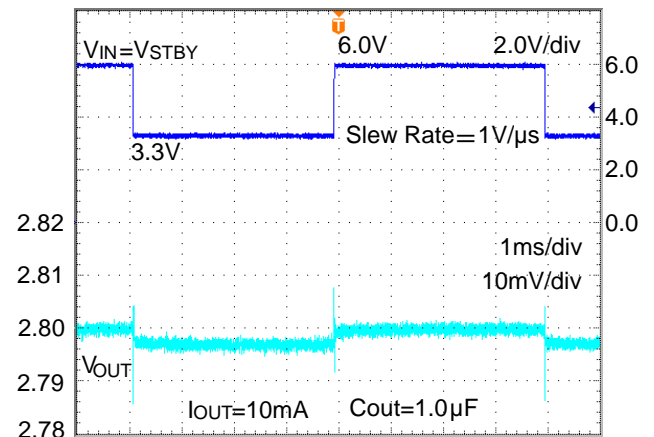

Figure 40. Line Transient Response (3.3V to 6.0V)

Reference data BU28JA2DG-C (Unless otherwise specified, Ta=25°C)

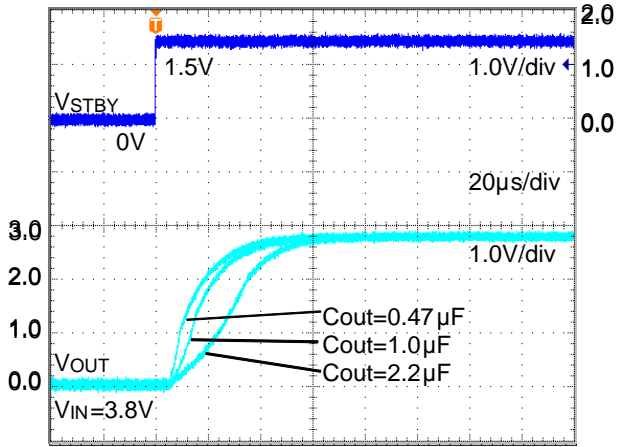

Figure 41. Startup Time (R_{OUT}=open)

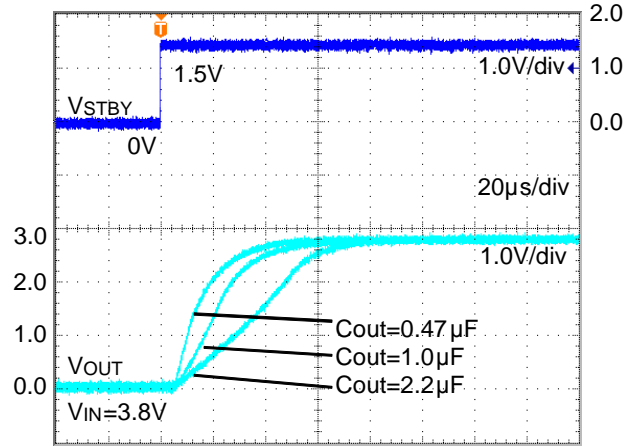

Figure 42. Startup Time (R_{OUT}=14Ω)

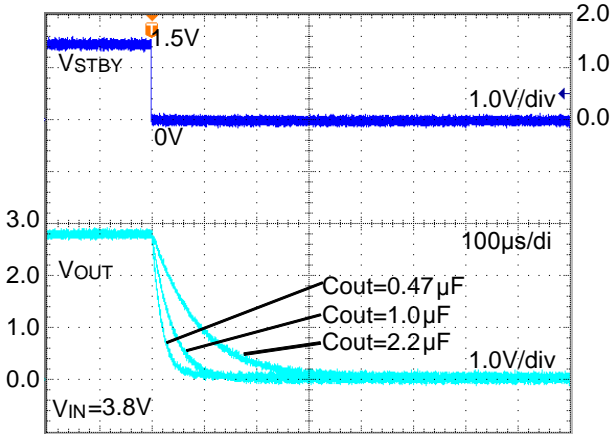

Figure 43. Discharge Time (R_{OUT}=open)

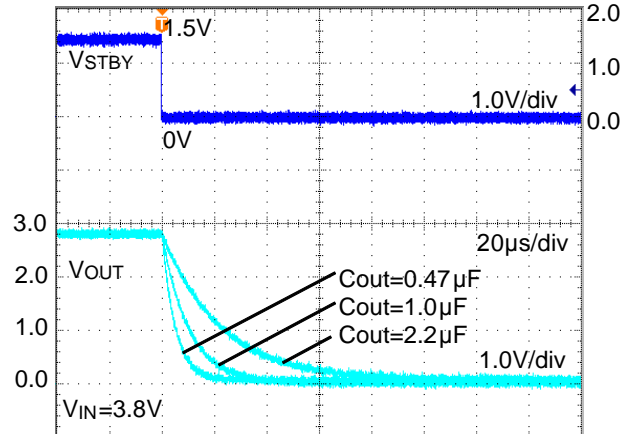

Figure 44. Discharge Time (R_{OUT}=14Ω)

Input/Output Capacitor

It is recommended that a capacitor is placed close to pin between input pin and GND as well as output pin and GND. The input capacitor becomes more necessary when the power supply impedance is high or when the PCB trace has significant length. Moreover, the higher the capacitance of the output capacitor the more stable the output will be, even with load and line voltage variations. However, please check the actual functionality by mounting on a board for the actual application. Also, ceramic capacitors usually have different thermal and equivalent series resistance characteristics and may degrade gradually over continued use.

For additional details, please check with the manufacturer and select the best ceramic capacitor for your application.

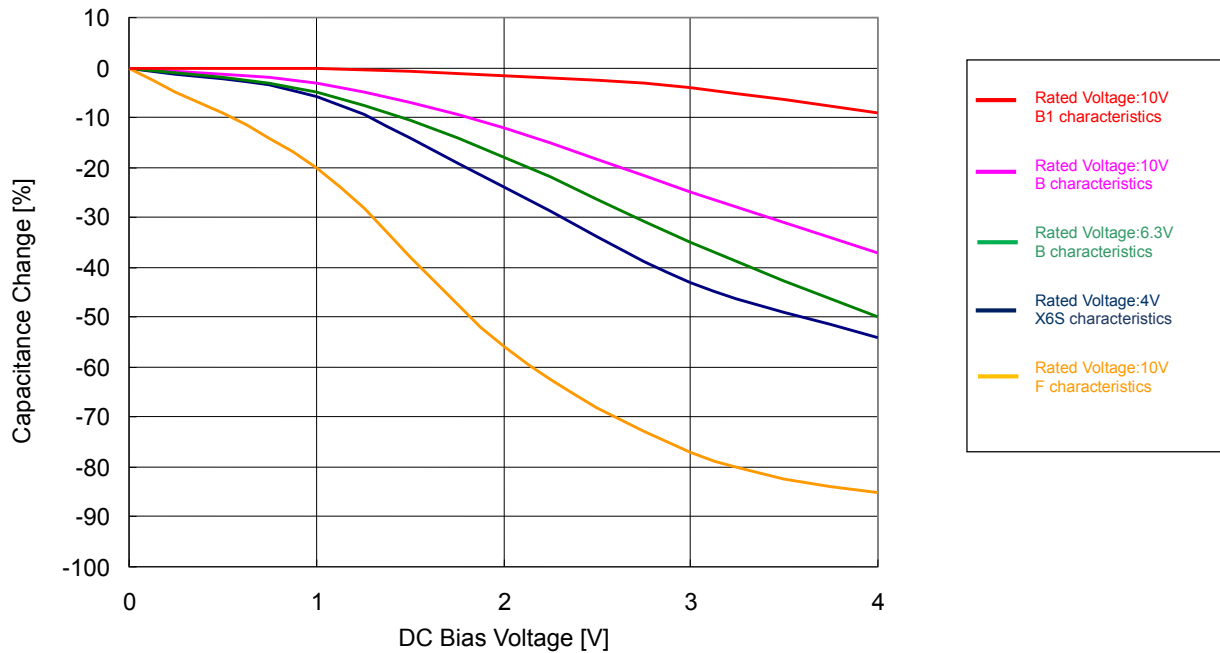

Figure 45. Ceramic Capacitor Capacitance Value vs. DC Bias Characteristics (Characteristics Example)

Equivalent Series Resistance (ESR) of a Ceramic Capacitor

To prevent oscillation, please attach a capacitor between VOUT and GND. Generally, capacitors have ESR (Equivalent Series Resistance) and is different for each type- ceramic, tantalum, electrolytic type etc. Please use the stable operating region graph on the right as reference then confirm capacitor's ESR to ensure that the actual application evaluation is within the stable operating range.

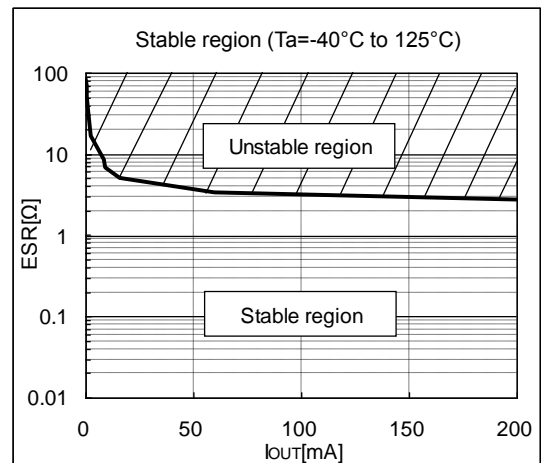

Figure 46. Stability area characteristics (Cin=0.47μF, Cout=0.47μF VIN=1.7V to 6.0V)

Power Dissipation

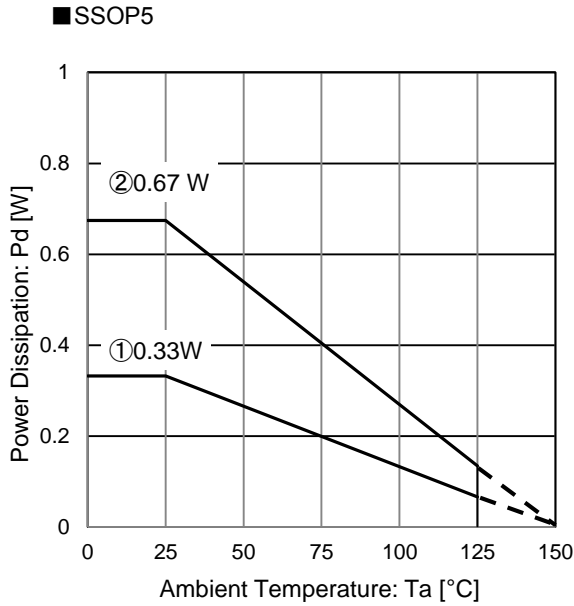

Figure 47. Power Dissipation (Reference Data)

IC mounted on ROHM standard board based on JEDEC.

- ① : 1-layer PCB
 (Copper foil area on the reverse side of PCB: 0 mm × 0 mm)
 Board material: FR4
 Board size: 114.3 mm × 76.2 mm × 1.57 mm
 Mount condition: PCB and exposed pad are soldered.
 Top copper foil: ROHM recommended footprint + wiring to measure, 2 oz. copper.
- ② : 4-layer PCB
 (2 inner layers copper foil area of PCB, copper foil area on the reverse side of PCB: 74.2 mm × 74.2 mm)
 Board material: FR4
 Board size: 114.3 mm × 76.2 mm × 1.6 mm
 Mount condition: PCB and exposed pad are soldered.
 Top copper foil: ROHM recommended footprint + wiring to measure, 2 oz. copper.
 2 inner layers copper foil area of PCB : 74.2 mm × 74.2 mm, 1 oz. copper.
 Copper foil area on the reverse side of PCB : 74.2 mm × 74.2 mm, 2 oz. copper.

Condition①: $\theta_{JA} = 376.5 \text{ }^\circ\text{C/W}$, $\Psi_{JT} \text{ (top center)} = 40 \text{ }^\circ\text{C/W}$

Condition②: $\theta_{JA} = 185.4 \text{ }^\circ\text{C/W}$, $\Psi_{JT} \text{ (top center)} = 30 \text{ }^\circ\text{C/W}$

Thermal Design

Within this IC, the power consumption is decided by the dropout voltage condition, the load current and the circuit current. Refer to power dissipation curves illustrated in Figure 47 when using the IC in an environment of $T_a \geq 25^\circ\text{C}$. Even if the ambient temperature T_a is at 25°C , depending on the input voltage and the load current, chip junction temperature can be very high. Consider the design to be $T_j \leq T_{j\text{max}} = 150^\circ\text{C}$ in all possible operating temperature range. Should by any condition the maximum junction temperature $T_{j\text{max}} = 150^\circ\text{C}$ rating be exceeded by the temperature increase of the chip, it may result in deterioration of the properties of the chip. The thermal impedance in this specification is based on recommended PCB and measurement condition by JEDEC standard. Verify the application and allow sufficient margins in the thermal design by the following method is used to calculate the junction temperature T_j . T_j can be calculated by either of the two following methods.

1. The following method is used to calculate the junction temperature T_j .

$$T_j = T_a + P_C \times \theta_{JA}$$

Where:

T_j : Junction Temperature
 T_a : Ambient Temperature
 P_C : Power Consumption
 θ_{JA} : Thermal Impedance
 (Junction to Ambient)

2. The following method is also used to calculate the junction temperature T_j .

$$T_j = T_T + P_C \times \Psi_{JT}$$

Where:

T_j : Junction Temperature
 T_T : Top Center of Case's (mold) Temperature
 P_C : Power consumption
 Ψ_{JT} : Thermal Impedance
 (Junction to Top Center of Case)

The following method is used to calculate the power consumption P_C (W).

$$P_C = (V_{IN} - V_{OUT}) \times I_{OUT} + V_{IN} \times I_{GND}$$

Where:

P_C : Power Consumption
 V_{IN} : Input Voltage
 V_{OUT} : Output Voltage
 I_{OUT} : Load Current
 I_{GND} : Circuit Current

• Calculation Example (SSOP5)

If $V_{IN} = 3.0\text{ V}$, $V_{OUT} = 1.8\text{ V}$, $I_{OUT} = 50\text{ mA}$, $I_{GND} = 33\text{ }\mu\text{A}$, the power consumption P_C can be calculated as follows:

$$\begin{aligned}
 P_C &= (V_{IN} - V_{OUT}) \times I_{OUT} + V_{IN} \times I_{GND} \\
 &= (3.0\text{ V} - 1.8\text{ V}) \times 50\text{ mA} + 3.0\text{ V} \times 33\text{ }\mu\text{A} \\
 &= 0.06\text{ W}
 \end{aligned}$$

At the ambient temperature $T_{amax} = 125^\circ\text{C}$, the thermal Impedance (Junction to Ambient) $\theta_{JA} = 185.4\text{ }^\circ\text{C/W}$ (4-layer PCB),

$$\begin{aligned}
 T_j &= T_{amax} + P_C \times \theta_{JA} \\
 &= 125\text{ }^\circ\text{C} + 0.06\text{ W} \times 185.4\text{ }^\circ\text{C/W} \\
 &= 136.1\text{ }^\circ\text{C}
 \end{aligned}$$

When operating the IC, the top center of case's (mold) temperature $T_T = 100\text{ }^\circ\text{C}$, $\Psi_{JT} = 40\text{ }^\circ\text{C/W}$ (1-layer PCB),

$$\begin{aligned}
 T_j &= T_T + P_C \times \Psi_{JT} \\
 &= 100\text{ }^\circ\text{C} + 0.06\text{ W} \times 40\text{ }^\circ\text{C/W} \\
 &= 102.4\text{ }^\circ\text{C}
 \end{aligned}$$

For optimum thermal performance, it is recommended to expand the copper foil area of the board, increasing the layer and thermal via between thermal land pad.

I/O Equivalence Circuits

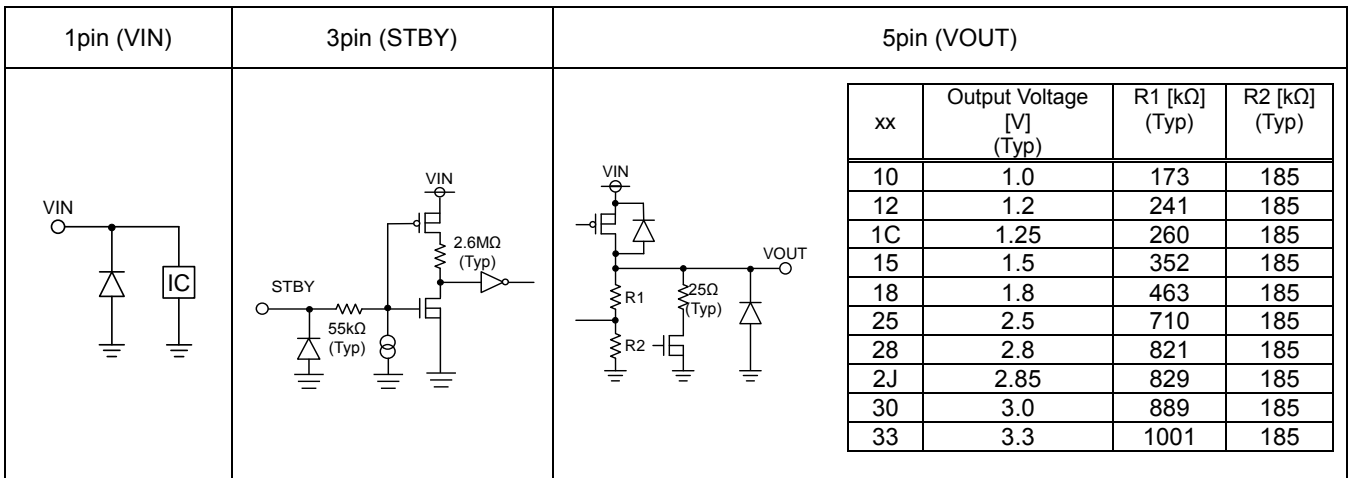

Figure 48. Input / Output equivalent circuit

Linear Regulators Surge Voltage Protection

The following provides instructions on surge voltage overs absolute maximum ratings polarity protection for ICs.

1. Applying positive surge to the input

If the possibility exists that surges higher than absolute maximum ratings 6.5 V will be applied to the input, a Zener Diode should be placed to protect the device in between the V_{IN} and the GND as shown in the figure 49.

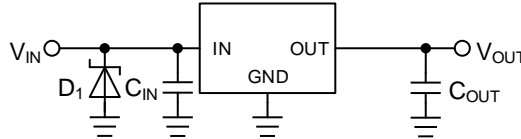

Figure 49. Surges Higher than 6.5 V will be Applied to the Input

2. Applying negative surge to the input

If the possibility exists that surges lower than absolute maximum ratings -0.3 V will be applied to the input, a Schottky Diode should be placed to protect the device in between the V_{IN} and the GND as shown in the figure 50.

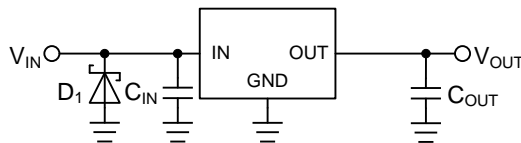

Figure 50. Surges Lower than -0.3 V will be Applied to the Input

Linear Regulators Reverse Voltage Protection

A linear regulator integrated circuit (IC) requires that the input voltage is always higher than the regulated voltage. Output voltage, however, may become higher than the input voltage under specific situations or circuit configurations, and that reverse voltage and current may cause damage to the IC. A reverse polarity connection or certain inductor components can also cause a polarity reversal between the input and output pins. The following provides instructions on reversed voltage polarity protection for ICs.

1. about Input /Output Voltage Reversal

In an MOS linear regulator, a parasitic element exists as a body diode in the drain-source junction portion of its power MOSFET. Reverse input/output voltage triggers the current flow from the output to the input through the body diode. The inverted current may damage or destroy the semiconductor elements of the regulator since the effect of the parasitic body diode is usually disregarded for the regulator behavior (Figure 51).

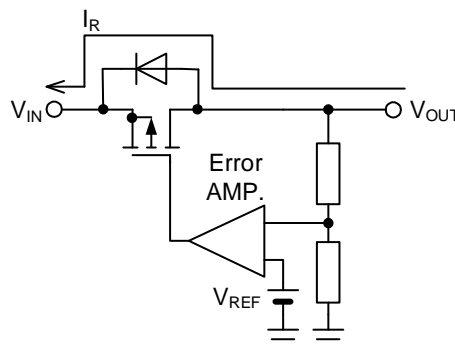

Figure 51. Reverse Current Path in an MOS Linear Regulator

An effective solution to this is an external bypass diode connected in-between the input and output to prevent the reverse current flow inside the IC (see Figure 52). Note that the bypass diode must be turned on before the internal circuit of the IC. Bypass diodes in the internal circuits of MOS linear regulators must have low forward voltage V_F . Some ICs are configured with current-limit thresholds to shut down high reverse current even when the output is off, allowing large leakage current from the diode to flow from the input to the output; therefore, it is necessary to choose one that has a small reverse current. Specifically, select a diode with a rated peak inverse voltage greater than the input to output voltage differential and rated forward current greater than the reverse current during use.

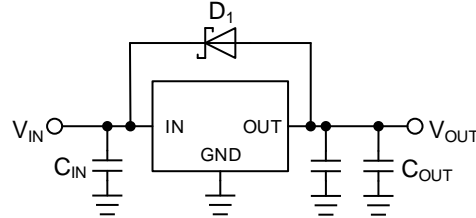

Figure 52. Bypass Diode for Reverse Current Diversion

The lower forward voltage (V_F) of Schottky barrier diodes cater to requirements of MOS linear regulators, however the main drawback is found in the level of their reverse current (I_R), which is relatively high. So, one with a low reverse current is recommended when choosing a Schottky diode. The V_R - I_R characteristics versus temperatures show increases at higher temperatures.

If V_{IN} is open in a circuit as shown in the following Figure 53 with its input/output voltage being reversed, the only current that flows in the reverse current path is the bias current of the IC. Because the amperage is too low to damage or destroy the parasitic element, a reverse current bypass diode is not required for this type of circuit.

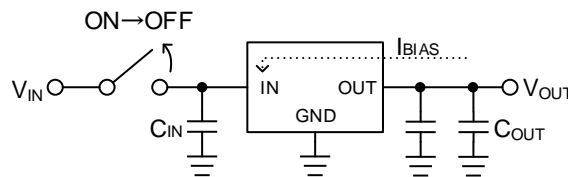

Figure 53. Open V_{IN}

2. Protection against Input Reverse Voltage

Accidental reverse polarity at the input connection flows a large current to the diode for electrostatic breakdown protection between the input pin of the IC and the GND pin, which may destroy the IC (see Figure 54).

A Schottky barrier diode or rectifier diode connected in series with the power supply as shown in Figure 55 is the simplest solution to prevent this from happening. The solution, however, is unsuitable for a circuit powered by batteries because there is a power loss calculated as $V_F \times I_{OUT}$, as the forward voltage V_F of the diode drops in a correct connection. The lower V_F of a Schottky barrier diode than that of a rectifier diode gives a slightly smaller power loss. Because diodes generate heat, care must be taken to select a diode that has enough allowance in power dissipation. A reverse connection allows a negligible reverse current to flow in the diode.

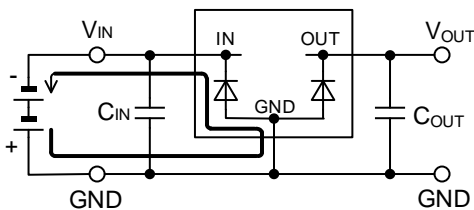

Figure 54. Current Path in Reverse Input Connection

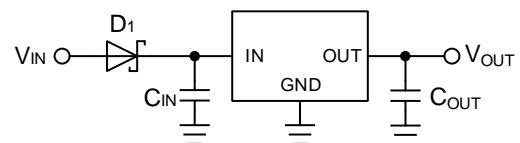

Figure 55. Protection against Reverse Polarity 1

Figure 56 shows a circuit in which a P-channel MOSFET is connected in series with the power. The diode located in the drain-source junction portion of the MOSFET is a body diode (parasitic element). The voltage drop in a correct connection is calculated by multiplying the resistance of the MOSFET being turned on by the output current I_{OUT} , therefore it is smaller than the voltage drop by the diode (see Figure 55) and results in less of a power loss. No current flows in a reverse connection where the MOSFET remains off.

If the voltage taking account of derating is greater than the voltage rating of MOSFET gate-source junction, lower the gate-source junction voltage by connecting voltage dividing resistors as shown in Figure 57.

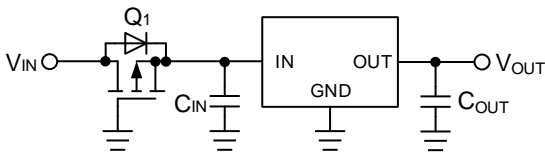

Figure 56. Protection against Reverse Polarity 2

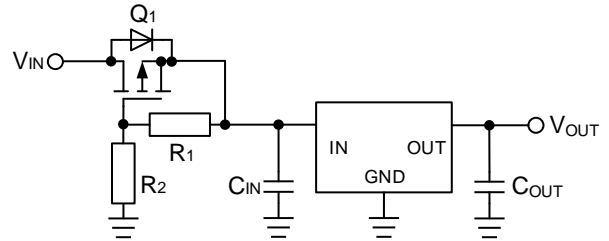

Figure 57. Protection against Reverse Polarity 3

3. Protection against Output Reverse Voltage when Output Connect to an Inductor

If the output load is inductive, electrical energy accumulated in the inductive load is released to the ground upon the output voltage turning off. In-between the IC output and ground pins is a diode for preventing electrostatic breakdown, in which a large current flows that could destroy the IC. To prevent this from happening, connect a Schottky barrier diode in parallel with the diode (see Figure 58).

Further, if a long wire is in use for the connection between the output pin of the IC and the load, observe the waveform on an oscilloscope, since it is possible that the load becomes inductive. An additional diode is needed for a motor load that is affected by its counter electromotive force, as it produces an electrical current in a similar way.

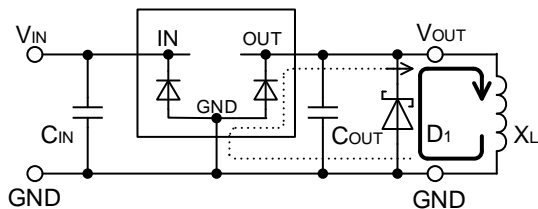
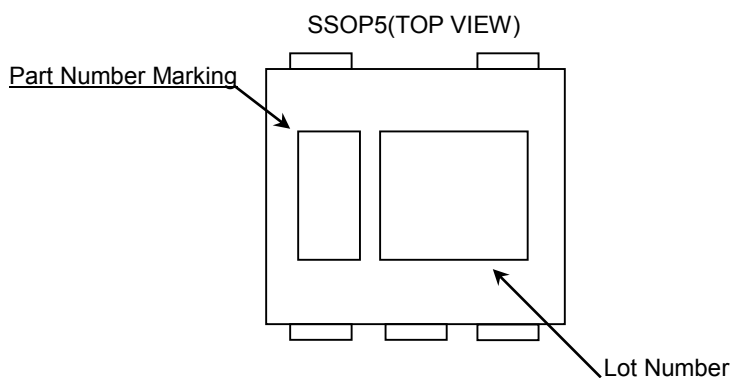

Figure 58. Current Path in Inductive Load (Output: Off)

Operational Notes

- 1) Absolute maximum ratings
This product is produced with strict quality control, however it may be destroyed if operated beyond its absolute maximum ratings. In addition, it is impossible to predict all destructive situations such as short-circuit modes, open circuit modes, etc. Therefore, it is important to consider circuit protection measures, like adding a fuse, in case the IC is operated in a special mode exceeding the absolute maximum ratings.
- 2) GND Potential
GND potential must be the lowest potential of all pins of the IC at all operating conditions. Ensure that no pins are at a voltage below the ground pin at any time, even during transient condition.
- 3) Setting of Heat
Carry out the heat design that have adequate margin considering Pd of actual working states.
- 4) Pin Short and Mistake Fitting
When mounting the IC on the PCB, pay attention to the orientation of the IC. If there is mistake in the placement, the IC may be burned up.
- 5) Mutual Impedance
Use short and wide wiring tracks for the power supply and ground to keep the mutual impedance as small as possible. Use a capacitor to keep ripple to a minimum.
- 6) STBY Pin Voltage
To enable standby mode for all channels, set the STBY pin to 0.5 V or less, and for normal operation, to 1.1 V or more. Setting STBY to a voltage over 0.5V and under 1.1 V may cause malfunction and should be avoided. Keep transition time between high and low (or vice versa) to a minimum. Additionally, if STBY is shorted to VIN, the IC will switch to standby mode and disable the output discharge circuit, causing a temporary voltage to remain on the output pin. If the IC is switched on again while this voltage is present, overshoot may occur on the output. Therefore, in applications where these pins are shorted, the output should always be completely discharged before turning the IC on.
- 7) Over Current Protection Circuit
Over current and short circuit protection is built-in at the output, and IC destruction is prevented at the time of load short circuit. These protection circuits are effective in the destructive prevention by sudden accidents, please avoid applications to where the over current protection circuit operates continuously.
- 8) Thermal Shutdown
This IC has Thermal Shutdown Circuit (TSD Circuit). When the temperature of IC Chip is higher than 175°C(typ), the output is turned off by TSD Circuit. TSD Circuit is only designed for protecting IC from thermal over load. Therefore it is not recommended that you design application where TSD will work in normal condition.
- 9) Output capacitor
To prevent oscillation at output, it is recommended that the IC be operated at the stable region shown in Figure 46. It operates at the capacitance of more than 0.47μF. As capacitance is larger, stability becomes more stable and characteristic of output load fluctuation is also improved.

Marking Diagram



Part Number	Output Voltage [V]	Part Number Marking
BU10JA2DG-C	1.0	91
BU12JA2DG-C	1.2	92
BU1CJA2DG-C	1.25	93
BU15JA2DG-C	1.5	94
BU18JA2DG-C	1.8	XV
BU25JA2DG-C	2.5	95
BU28JA2DG-C	2.8	XW
BU2JJA2DG-C	2.85	96
BU30JA2DG-C	3.0	97
BU33JA2DG-C	3.3	98

Physical Dimension and Packing Information

Package Name	SSOP5
--------------	-------

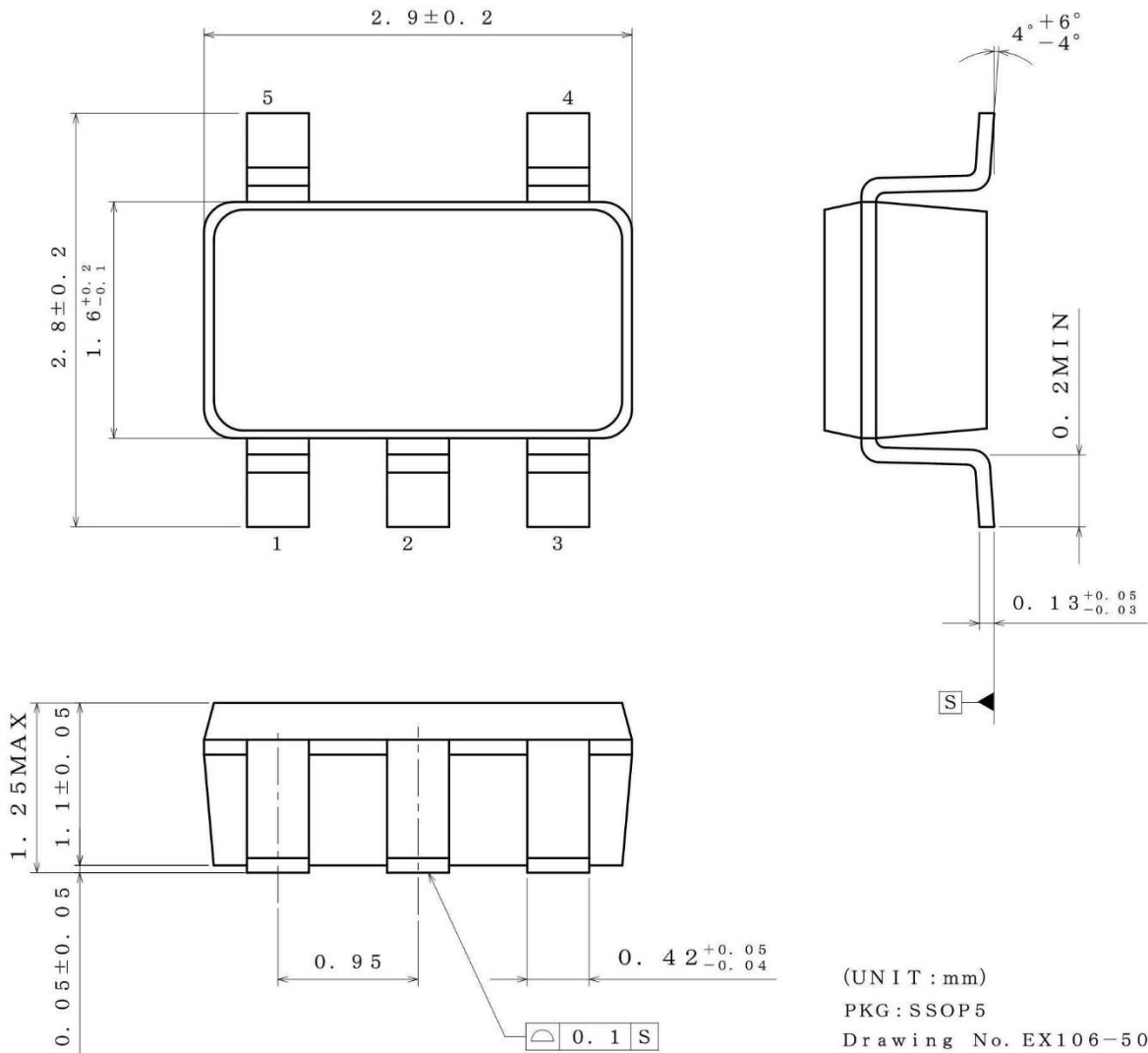

< Tape and Reel Information >

Tape	Embossed carrier tape
Quantity	3000pcs
Direction of feed	TR (The direction is the 1 pin of product is at the upper right when you hold reel on the left hand and you pull out the tape on the right hand)

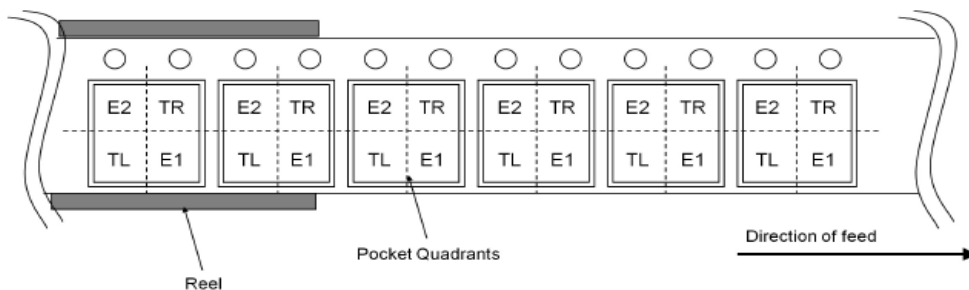

Revision History

Date	Revision	Changes
27.Feb.2017	001	New Release
30.Mar.2017	002	p.21 The circuit of 5pin(VOUT) is modified in "I/O Equivalence Circuits". p.26 Marking of BU28JA2DG-C is revised. Others, correction of errors.
10.Nov.2017	003	Lineup is added. p.25 An expression method of "Marking Diagram" is changed. p.27 Figure of "Packing Information" is updated. Others, correction of errors.

Notice

Precaution on using ROHM Products

1. If you intend to use our Products in devices requiring extremely high reliability (such as medical equipment ^(Note 1), aircraft/spacecraft, nuclear power controllers, etc.) and whose malfunction or failure may cause loss of human life, bodily injury or serious damage to property ("Specific Applications"), please consult with the ROHM sales representative in advance. Unless otherwise agreed in writing by ROHM in advance, ROHM shall not be in any way responsible or liable for any damages, expenses or losses incurred by you or third parties arising from the use of any ROHM's Products for Specific Applications.

(Note1) Medical Equipment Classification of the Specific Applications

JAPAN	USA	EU	CHINA
CLASS III	CLASS III	CLASS II b	CLASS III
CLASS IV		CLASS III	

2. ROHM designs and manufactures its Products subject to strict quality control system. However, semiconductor products can fail or malfunction at a certain rate. Please be sure to implement, at your own responsibilities, adequate safety measures including but not limited to fail-safe design against the physical injury, damage to any property, which a failure or malfunction of our Products may cause. The following are examples of safety measures:
 - [a] Installation of protection circuits or other protective devices to improve system safety
 - [b] Installation of redundant circuits to reduce the impact of single or multiple circuit failure
3. Our Products are not designed under any special or extraordinary environments or conditions, as exemplified below. Accordingly, ROHM shall not be in any way responsible or liable for any damages, expenses or losses arising from the use of any ROHM's Products under any special or extraordinary environments or conditions. If you intend to use our Products under any special or extraordinary environments or conditions (as exemplified below), your independent verification and confirmation of product performance, reliability, etc. prior to use, must be necessary:
 - [a] Use of our Products in any types of liquid, including water, oils, chemicals, and organic solvents
 - [b] Use of our Products outdoors or in places where the Products are exposed to direct sunlight or dust
 - [c] Use of our Products in places where the Products are exposed to sea wind or corrosive gases, including Cl₂, H₂S, NH₃, SO₂, and NO₂
 - [d] Use of our Products in places where the Products are exposed to static electricity or electromagnetic waves
 - [e] Use of our Products in proximity to heat-producing components, plastic cords, or other flammable items
 - [f] Sealing or coating our Products with resin or other coating materials
 - [g] Use of our Products without cleaning residue of flux (even if you use no-clean type fluxes, cleaning residue of flux is recommended); or Washing our Products by using water or water-soluble cleaning agents for cleaning residue after soldering
 - [h] Use of the Products in places subject to dew condensation
4. The Products are not subject to radiation-proof design.
5. Please verify and confirm characteristics of the final or mounted products in using the Products.
6. In particular, if a transient load (a large amount of load applied in a short period of time, such as pulse. is applied, confirmation of performance characteristics after on-board mounting is strongly recommended. Avoid applying power exceeding normal rated power; exceeding the power rating under steady-state loading condition may negatively affect product performance and reliability.
7. De-rate Power Dissipation depending on ambient temperature. When used in sealed area, confirm that it is the use in the range that does not exceed the maximum junction temperature.
8. Confirm that operation temperature is within the specified range described in the product specification.
9. ROHM shall not be in any way responsible or liable for failure induced under deviant condition from what is defined in this document.

Precaution for Mounting / Circuit board design

1. When a highly active halogenous (chlorine, bromine, etc.) flux is used, the residue of flux may negatively affect product performance and reliability.
2. In principle, the reflow soldering method must be used on a surface-mount products, the flow soldering method must be used on a through hole mount products. If the flow soldering method is preferred on a surface-mount products, please consult with the ROHM representative in advance.

For details, please refer to ROHM Mounting specification

Precautions Regarding Application Examples and External Circuits

1. If change is made to the constant of an external circuit, please allow a sufficient margin considering variations of the characteristics of the Products and external components, including transient characteristics, as well as static characteristics.
2. You agree that application notes, reference designs, and associated data and information contained in this document are presented only as guidance for Products use. Therefore, in case you use such information, you are solely responsible for it and you must exercise your own independent verification and judgment in the use of such information contained in this document. ROHM shall not be in any way responsible or liable for any damages, expenses or losses incurred by you or third parties arising from the use of such information.

Precaution for Electrostatic

This Product is electrostatic sensitive product, which may be damaged due to electrostatic discharge. Please take proper caution in your manufacturing process and storage so that voltage exceeding the Products maximum rating will not be applied to Products. Please take special care under dry condition (e.g. Grounding of human body / equipment / solder iron, isolation from charged objects, setting of Ionizer, friction prevention and temperature / humidity control).

Precaution for Storage / Transportation

1. Product performance and soldered connections may deteriorate if the Products are stored in the places where:
 - [a] the Products are exposed to sea winds or corrosive gases, including Cl₂, H₂S, NH₃, SO₂, and NO₂
 - [b] the temperature or humidity exceeds those recommended by ROHM
 - [c] the Products are exposed to direct sunshine or condensation
 - [d] the Products are exposed to high Electrostatic
2. Even under ROHM recommended storage condition, solderability of products out of recommended storage time period may be degraded. It is strongly recommended to confirm solderability before using Products of which storage time is exceeding the recommended storage time period.
3. Store / transport cartons in the correct direction, which is indicated on a carton with a symbol. Otherwise bent leads may occur due to excessive stress applied when dropping of a carton.
4. Use Products within the specified time after opening a humidity barrier bag. Baking is required before using Products of which storage time is exceeding the recommended storage time period.

Precaution for Product Label

A two-dimensional barcode printed on ROHM Products label is for ROHM's internal use only.

Precaution for Disposition

When disposing Products please dispose them properly using an authorized industry waste company.

Precaution for Foreign Exchange and Foreign Trade act

Since concerned goods might be fallen under listed items of export control prescribed by Foreign exchange and Foreign trade act, please consult with ROHM in case of export.

Precaution Regarding Intellectual Property Rights

1. All information and data including but not limited to application example contained in this document is for reference only. ROHM does not warrant that foregoing information or data will not infringe any intellectual property rights or any other rights of any third party regarding such information or data.
2. ROHM shall not have any obligations where the claims, actions or demands arising from the combination of the Products with other articles such as components, circuits, systems or external equipment (including software).
3. No license, expressly or implied, is granted hereby under any intellectual property rights or other rights of ROHM or any third parties with respect to the Products or the information contained in this document. Provided, however, that ROHM will not assert its intellectual property rights or other rights against you or your customers to the extent necessary to manufacture or sell products containing the Products, subject to the terms and conditions herein.

Other Precaution

1. This document may not be reprinted or reproduced, in whole or in part, without prior written consent of ROHM.
2. The Products may not be disassembled, converted, modified, reproduced or otherwise changed without prior written consent of ROHM.
3. In no event shall you use in any way whatsoever the Products and the related technical information contained in the Products or this document for any military purposes, including but not limited to, the development of mass-destruction weapons.
4. The proper names of companies or products described in this document are trademarks or registered trademarks of ROHM, its affiliated companies or third parties.

General Precaution

1. Before you use our Products, you are requested to carefully read this document and fully understand its contents. ROHM shall not be in any way responsible or liable for failure, malfunction or accident arising from the use of any ROHM's Products against warning, caution or note contained in this document.
2. All information contained in this document is current as of the issuing date and subject to change without any prior notice. Before purchasing or using ROHM's Products, please confirm the latest information with a ROHM sales representative.
3. The information contained in this document is provided on an "as is" basis and ROHM does not warrant that all information contained in this document is accurate and/or error-free. ROHM shall not be in any way responsible or liable for any damages, expenses or losses incurred by you or third parties resulting from inaccuracy or errors of or concerning such information.

Mouser Electronics

Authorized Distributor

Click to View Pricing, Inventory, Delivery & Lifecycle Information:

[ROHM Semiconductor:](#)

[BU15JA2DG-CTR](#) [BU1CJA2DG-CTR](#) [BU2JJA2DG-CTR](#) [BU33JA2DG-CTR](#)

Компания «Океан Электроники» предлагает заключение долгосрочных отношений при поставках импортных электронных компонентов на взаимовыгодных условиях!

Наши преимущества:

- Поставка оригинальных импортных электронных компонентов напрямую с производств Америки, Европы и Азии, а так же с крупнейших складов мира;
- Широкая линейка поставок активных и пассивных импортных электронных компонентов (более 30 млн. наименований);
- Поставка сложных, дефицитных, либо снятых с производства позиций;
- Оперативные сроки поставки под заказ (от 5 рабочих дней);
- Экспресс доставка в любую точку России;
- Помощь Конструкторского Отдела и консультации квалифицированных инженеров;
- Техническая поддержка проекта, помощь в подборе аналогов, поставка прототипов;
- Поставка электронных компонентов под контролем ВП;
- Система менеджмента качества сертифицирована по Международному стандарту ISO 9001;
- При необходимости вся продукция военного и аэрокосмического назначения проходит испытания и сертификацию в лаборатории (по согласованию с заказчиком);
- Поставка специализированных компонентов военного и аэрокосмического уровня качества (Xilinx, Altera, Analog Devices, Intersil, Interpoint, Microsemi, Actel, Aeroflex, Peregrine, VPT, Syfer, Eurofarad, Texas Instruments, MS Kennedy, Miteq, Cobham, E2V, MA-COM, Hittite, Mini-Circuits, General Dynamics и др.);

Компания «Океан Электроники» является официальным дистрибьютором и эксклюзивным представителем в России одного из крупнейших производителей разъемов военного и аэрокосмического назначения «JONHON», а так же официальным дистрибьютором и эксклюзивным представителем в России производителя высокотехнологичных и надежных решений для передачи СВЧ сигналов «FORSTAR».



JONHON

«JONHON» (основан в 1970 г.)

Разъемы специального, военного и аэрокосмического назначения:

(Применяются в военной, авиационной, аэрокосмической, морской, железнодорожной, горно- и нефтедобывающей отраслях промышленности)

«FORSTAR» (основан в 1998 г.)

ВЧ соединители, коаксиальные кабели, кабельные сборки и микроволновые компоненты:

(Применяются в телекоммуникациях гражданского и специального назначения, в средствах связи, РЛС, а так же военной, авиационной и аэрокосмической отраслях промышленности).



Телефон: 8 (812) 309-75-97 (многоканальный)

Факс: 8 (812) 320-03-32

Электронная почта: ocean@oceanchips.ru

Web: <http://oceanchips.ru/>

Адрес: 198099, г. Санкт-Петербург, ул. Калинина, д. 2, корп. 4, лит. А