

# Pneumatic logic components

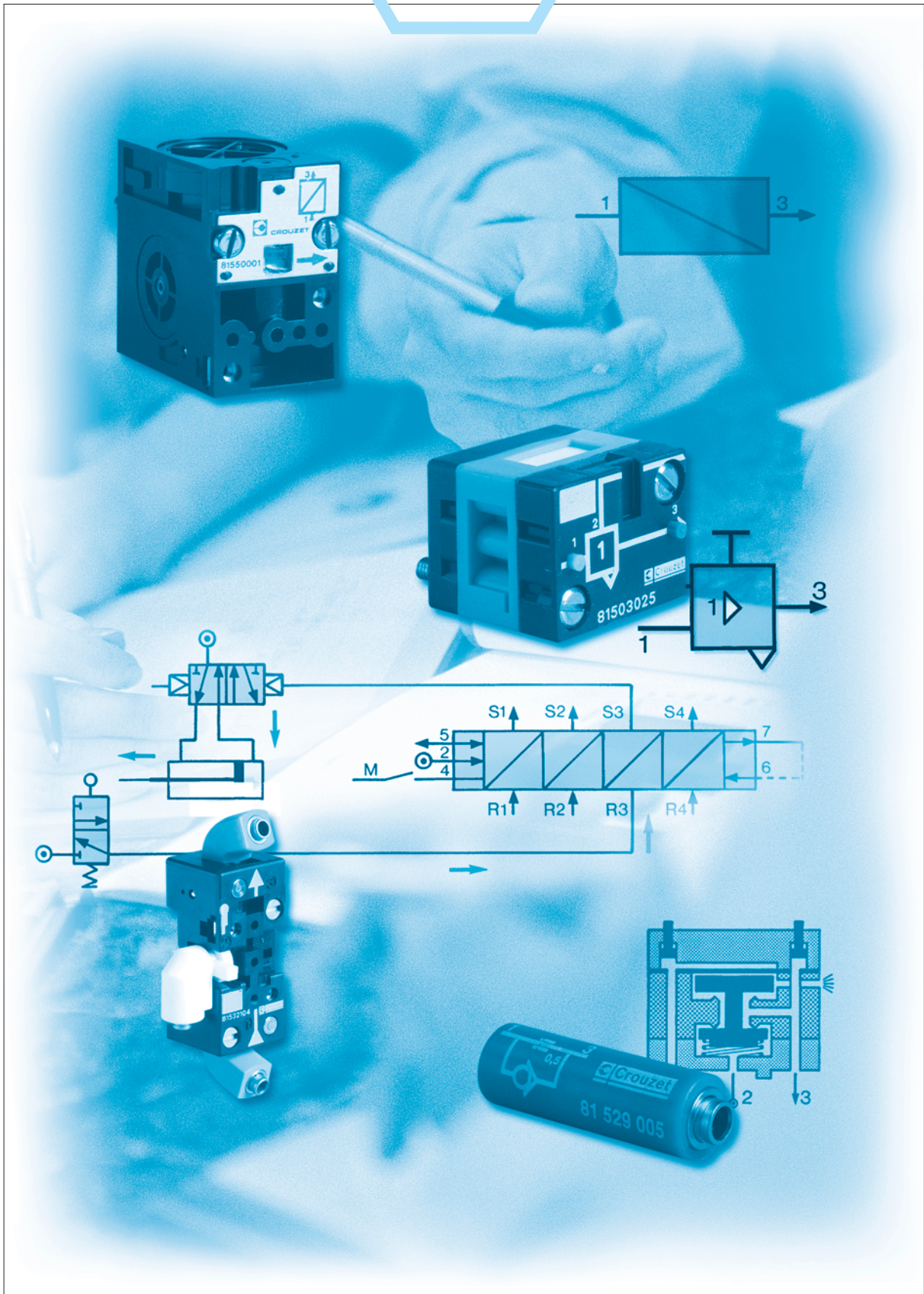

Visit our website for further information [www.crouzet.com](http://www.crouzet.com)

# General characteristics

## Operating fluid

- Compressed air or inert gas.

## Conditions of use

- Operating pressure 2 at 8 bars (except for special conditions).
- Fluid: Filtered air to 50 microns - non lubricated.
- Operating temperature from - 5° C to + 50° C (under + 5° C the dew point must be below 10° C for the application).
- For optimum performance, the elements should be inter-connected by air supply tubing with an internal diameter  $\geq$  at 2.5 mm.

## Mounting recommendations

- The elements should be mounted and piped in a clean atmosphere in order to prevent any form of pollution entering the system.
- Minimum torque for element fixing screws: 5 cm/kg.
- maximum torque for element fixing screws: 10 cm/kg.

## Characteristics common to all elements in the modular system

- The characteristics have been obtained with a supply pressure at 6 bars.
- The flow in NI/min is the number of litres of air at normal atmospheric pressure obtained with the output open to atmosphere and the supply pressure at 4 bars
- The consumption in NI/min is the number of litres of free air necessary for the unit to function.
- kV = the flow coefficient of the equipment.
- Mechanical life > 10<sup>7</sup> operations.

## flow graphs

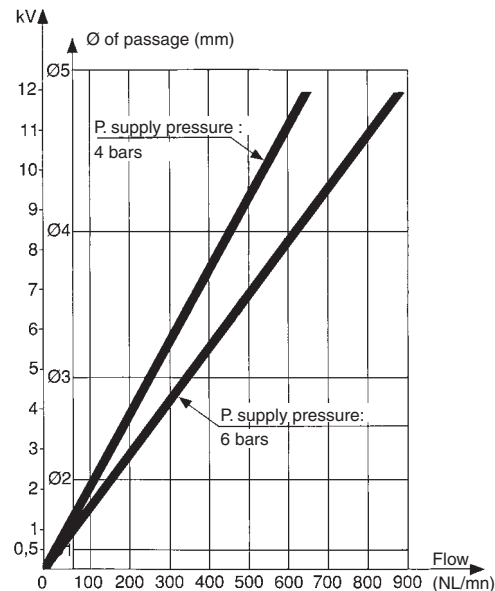

## Sequencer modules

Operation results from the combination of a sequential cycle. A system comprises individual modules which are joined together by means of a sub-base. Each module has a memory which delivers an output signal and receives an input signal.

An indicator on each module allows the operator to monitor the progress of the cycle and identify quickly and easily any fault which may occur.

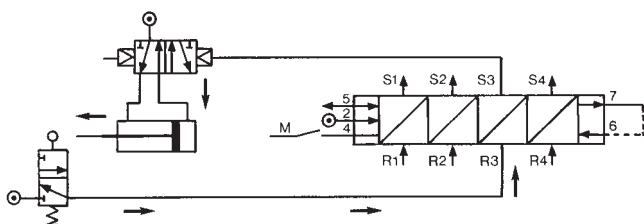

Operation results from the combination of three functions (memory, AND and OR) which constitute each module.

The memory activates the output and gives priority to the reset signal. The AND element ensures the transition to the next module but only if an input signal is present.

The OR element ensures the resetting of all previously operated modules

## Function diagram

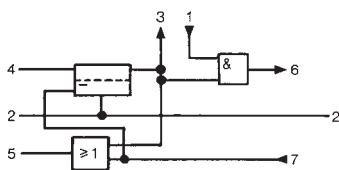

## sequencer module with maintained reset

### Brake

This maintains the memory spool in position only when the supply is lost.

## Module with auto reset

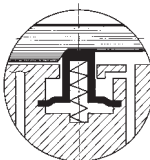

### Brake

This returns the memory spool to the reset condition only when the supply is lost

### Shift register

The general principle is to advance the sequencer step by command impulses to the inputs of the even steps, alternating with the command impulses to the inputs of the odd steps.

Used for example on a transfer machine to shift the information "bad component" collected at a test-test "n" steps further along the machine to a reject station.

## Function diagram

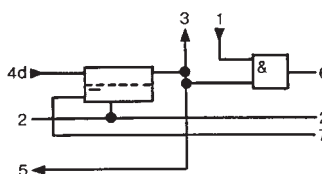

## Auto reset sequencer module

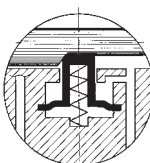

# Ex Sequencer modules

FILE No. C.PN.HOM.00009.FR  
 INERIS No. 18409/05

Equipment intended for use in potentially explosive atmospheres conforming to Directive 94/9/EC

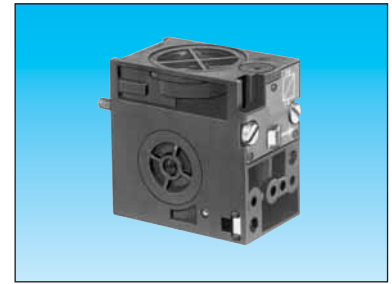
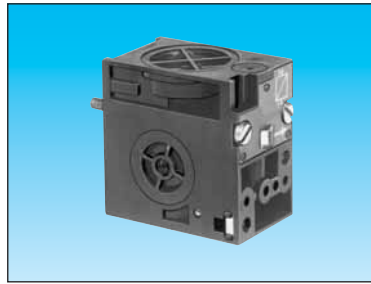

Versions	sequencer shift register	81 550 013 with 'maintain'	81 550 213 Reset to zero	81 550 403 with 'maintain'	81 550 603 Reset to zero
Classification	CE II 2 GD c IIB 65°C(T6) X				

## Symbol



## Characteristics

Operating pressure	bar	2 • 8	2 • 8	2 • 8	2 • 8
Orifice diameter	mm	2.7	2.7	2.7	2.7
Flow at 6 bars	Nl/min	150	150	150	150
Operating temperature	°C	-5 +50	-5 +50	-5 +50	-5 +50
Mechanical life 5 x 10 <sup>6</sup> at 6 bars		•	•	•	•
Connection - Sub-base page 26		•	•	•	•
Weight	g	70	70	70	70

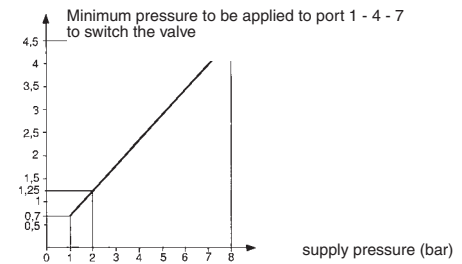

## Principle of operation

(supplied without logic element. For choice of units see page 28-29)

### Sequencer module with maintained reset

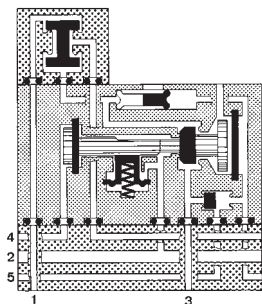

- 1 - Input signal
- 2 - Supply
- 3 - Output signal
- 4 - Start signal
- 5 - In cycle signal
- 6 - End of cycle signal
- 7 - Reset to zero signal

### Shift register with maintained reset

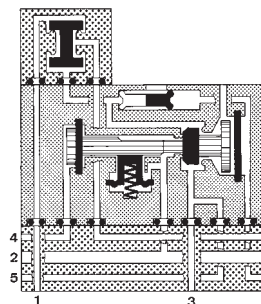

- 1 - Input signal
- 2 - Supply
- 3 - Output signal
- 4 - Start signal
- 5 - In cycle signal
- 6 - End of cycle signal
- 7 - Reset to zero signal

## Dimensions

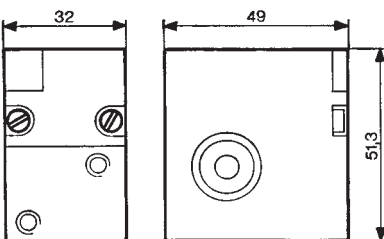

## Mounting plan for sequencer

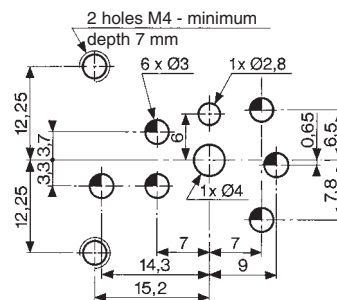

To order an Ex product, you must complete the form on page 53.



# Ex Sequencer sub-bases

FILE No. C.PN.HOM.00009.FR  
 INERIS No. 18409/05

Equipment intended for use in potentially explosive atmospheres conforming to Directive 94/9/EC

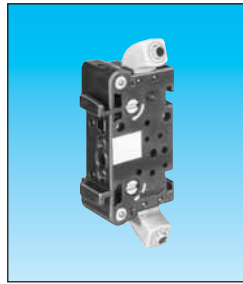

81 551 104  
 Sub-base (DIN oméga)



81 552 105  
 End bases - one pair

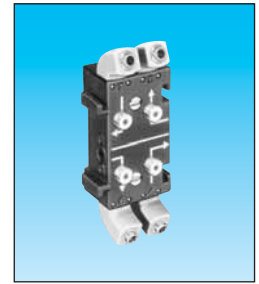

81 552 605  
 Diversion base

Versions Front connecting (DIN-omega)  
 Rear connecting (with clips)

Classification **CE II 2 GD c IIB T6 X**

## Characteristics

Sub-bases	Rotatable connectors		•	•	•
(fitted)	Pressure indicators		•	•	•
Operating temperature	°C	-5 +50		-5 +50	-5 +50
Weight	g	55		135	60

## Sequencer connections

### Front connecting

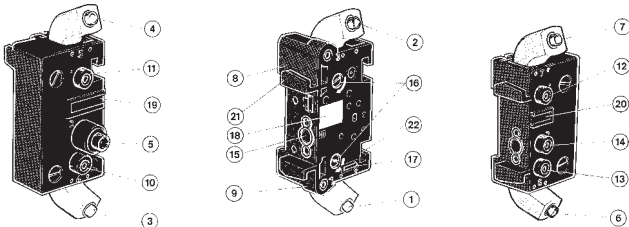
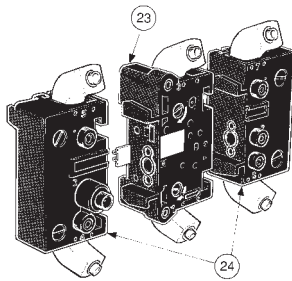

- 1 - Input port (green port 1) Ø 4
- 2 - Output port (red port 1) Ø 4
- 3 - Input port, cycle start (green port 1) Ø 4
- 4 - Output port, in-cycle signal (red port 1) Ø 4
- 5 - Output port, cycle end (red port 6) Ø 4
- 6 - Output port, cycle end (red port 6) Ø 4
- 7 - Input port, reset to zero (green port 7) Ø 4
- 8 - Output indicator (red)
- 9 - Input indicator (green)
- 10 - Cycle start indicator at port 4 (green)
- 11 - In-cycle indicator at port 5 (red)
- 12 - Input indicator at port 7 (green)
- 13 - End of cycle indicator at port 6 (red)
- 14 - Supply indicator at port 2 (yellow)
- 15 - Interconnecting ports
- 16 - Fixing screws
- 17 - Engraved arrow to indicate direction of sequence
- 18 - Marking tag
- 19 - Marking tag position
- 20 - Marking tag position
- 21 - Mounting tongue
- 22 - Mounting groove
- 23 - Sub-base
- 24 - End bases

## Dimensions

### Front connecting

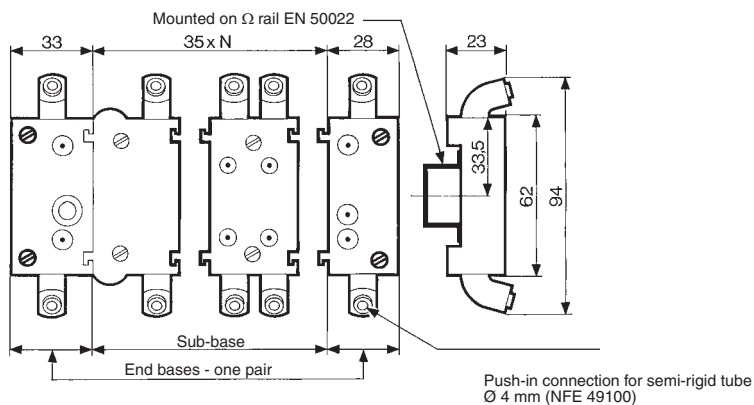

To order an Ex product, you must complete the form on page 53.

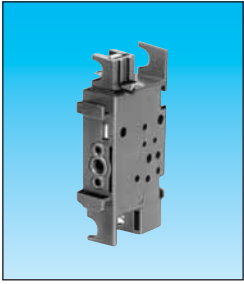

81 551 004

81 552 005

Sub-base (with clips)

End bases - one pair

CE II 2 GD c IIB T6 X

-5 +50  
40

-5 +50  
120

**Rear connecting**

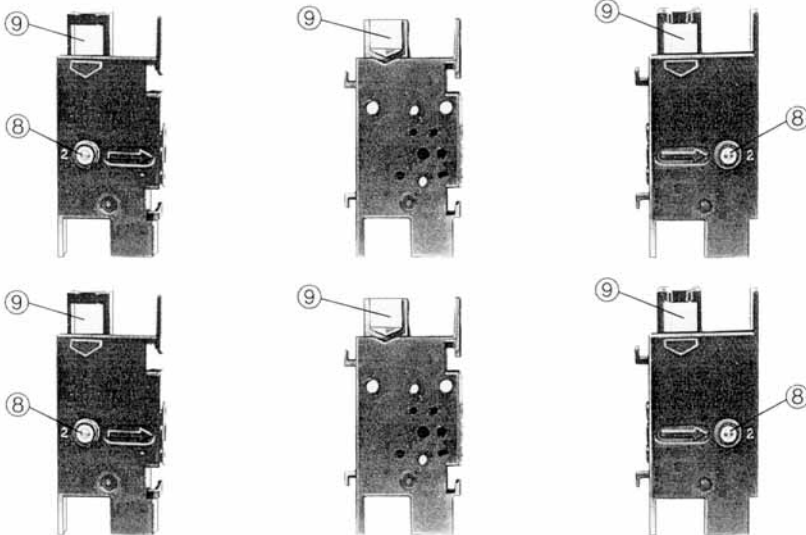

- 1 - Input port (marked port 1)
- 2 - Supply port (Port 2)
- 3 - Output port (Port 3)
- 4 - Cycle start signal port (Port 4)
- 5 - In-cycle signal port (Port 5)
- 6 - End of cycle signal port (Port 6)
- 7 - Reset to zero signal port (Port 7)
- 8 - Indicator at supply port
- 9 - Marking area

**Rear connecting**

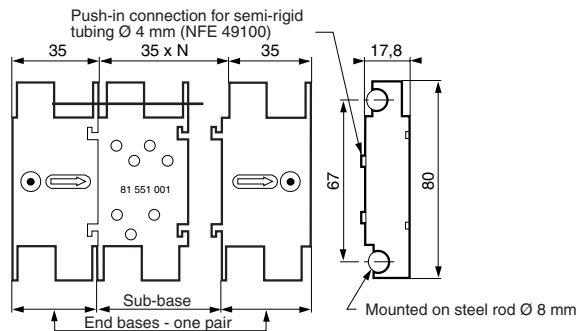

To order an product, you must complete the form on page 53.

FILE No. C.PN.HOM.00007.FR  
 INERIS No. 18408/05

**Equipment intended for use in potentially explosive atmospheres conforming to Directive 94/9/EC**

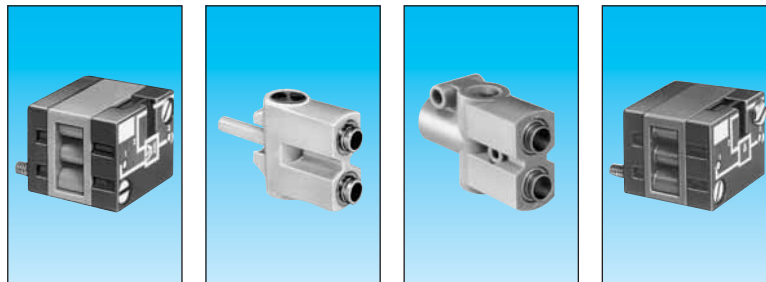

Functions	OR	81 521 508	81 540 015	81 540 017	81 522 505
	AND	—	—	—	—
	YES	—	—	—	—
	NO	—	—	—	—
Version		On Sub-base page 36-37	Plug-in Ø 4	Plug-in Ø 6	On Sub-base page 36-37

Classification **CE II 2 G D c IIB 65°C(T6) X**

### Symbol

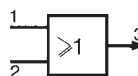

### Characteristics

Push-in connection for semi-rigid tubing (NFE 49100)	Male/Female/Female	—	Ø 4 mm	—	—
	Female/Female/Female	—	—	Ø 6 mm	—
Colour		Blue	Blue	Blue	Green
Operating pressure	bar	2 • 8	2 • 8	2 • 8	2 • 8
Orifice diameter	mm	2.7	2.7	4	2.7
Flow at 6 bars	NI/min	170	170	200	170
Pressure indicator		•	—	—	•
Switching time	ms	—	—	—	—
Operating temperature	°C	-5 +50	-5 +50	-5 +50	-5 +50
Mechanical life	operations	>10 <sup>7</sup>	>10 <sup>7</sup>	>10 <sup>7</sup>	>10 <sup>7</sup>
Weight	g	25	12	25	25

### Pilot/pressure curves

Pp : Pilot pressure  
 Pa : Supply pressure

### Principle of operation

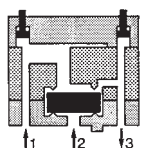

#### Cellule OR

The output signal "S" is present when a signal at "a" OR "b" is present:

$$S = a \text{ OR } b$$

$$S = a + b$$

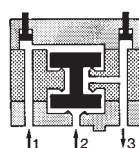

#### Cellule AND

The output signal "S" is present only when signals "a" AND "b" are present simultaneously:

$$S = a \text{ AND } b$$

$$S = a \cdot b$$

### Dimensions

81 521 508 - 81 522 505

81 540 017 - 81 541 017

81 540 015 - 81 541 015

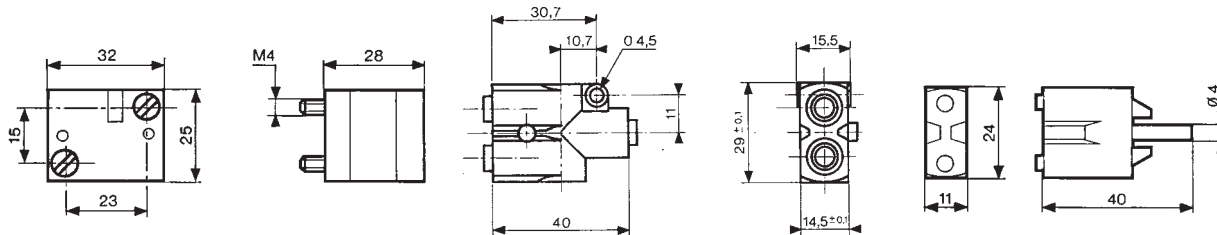

### Other information

See page 36-37 for mounting plan for logic elements.

To order an Ex product, you must complete the form on page 53.

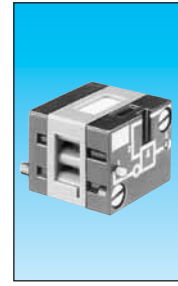
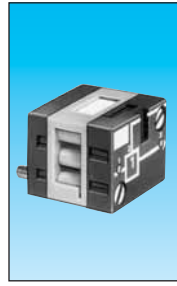
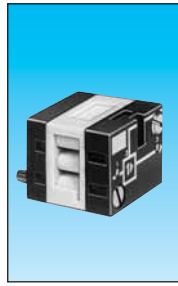

81 541 0015

81 541 017

81 501 031

81 503 028

81 504 035

81 506 027

Plug-in  
Ø 4

Plug-in  
Ø 6

On sub-base  
page 36-37

Threshold  
On sub-base page  
36-37

Threshold  
On sub-base page  
36-37

Threshold  
On sub-base page  
36-37

CE II 2 G D c IIB 65°C(T6) X

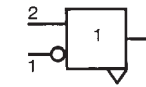
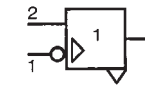
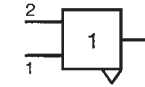
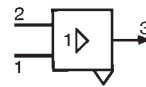
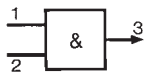

Ø 4 mm

Green

2 • 8

2.7

150

-5 +50

>10<sup>7</sup>

13

Ø 6 mm

Green

2 • 8

4

200

-5 +50

>10<sup>7</sup>

25

Yellow

2 • 8

2.7

170

< 4

-5 +50

>10<sup>7</sup>

30

Orange

2 • 8

2.7

170

< 4

-5 +50

>10<sup>7</sup>

30

Light grey

2 • 8

2.7

170

< 4

-5 +50

>10<sup>7</sup>

30

Dark grey

2 • 8

2.7

170

< 4

-5 +50

>10<sup>7</sup>

30

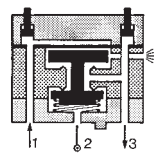
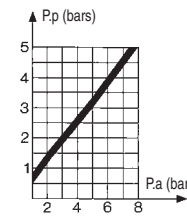
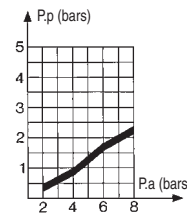
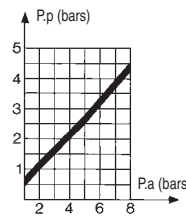
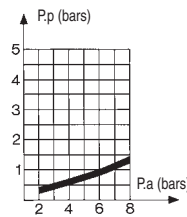

**YES element**

The output signal "S" is only present when the pilot is present "a" is present:

S = a YES b

S = a

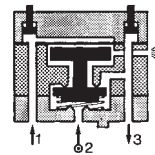

**NOT element**

The output signal "s" is present only if the input signal "a" is NOT present. The output signal is therefore the inverse of the pilot signal:

S = NOT a

S =  $\bar{a}$

If the supply port is connected to a 2nd input "b", the function obtained is called inhibition:

S = NOT a AND b

S =  $\bar{a} \cdot b$

81 501 031 - 81 503 028

81 504 035 - 81 506 027

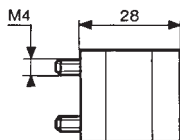
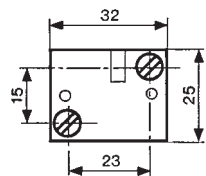

To order an product, you must complete the form on page 53.

# Ex Memory element

FILE No. C.PN.HOM.00004.FR  
 INERIS No. 17564/04

Equipment intended for use in potentially explosive atmospheres conforming to Directive 94/9/EC

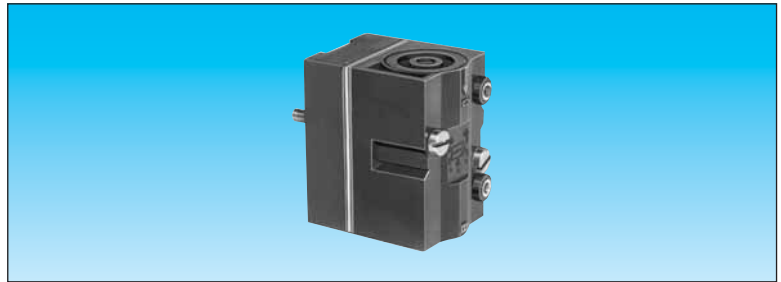

Version	81 523 205 With pressure indicator	81 523 608 With pressure indicator and manual override
Classification	CE II 2 G D c IIB 55°C(T6) X	

## Symbol

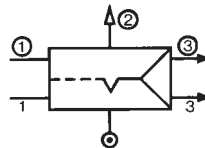

## Characteristics

Colour		Black	Black
Operating pressure	bar	2 → 8	2 → 8
Orifice diameter	mm	2.7	2.7
Minimum memory pilot pressure	bar	2.5	2.5
Operating temperature	°C	-5 +50	-5 +50
Flow at 6 bars	NI/min	200	200
Connection - On sub-base page 36-37		●	●
Weight	g	90	90

## Principle of operation

The function is that of a 4/2 valves. The appearance of signal "X1" causes the displacement of the slide valve. The output port "x" is then put under pressure. This state is remembered until the arrival of signal "X0". This signal reverses the slide valve, the output "x" is put under pressure. This state is likewise remembered. The output:

- "x" under pressure indicates that the information in the MEMORY is "X1",
- "x" under pressure indicates that the information in the MEMORY is "X0".

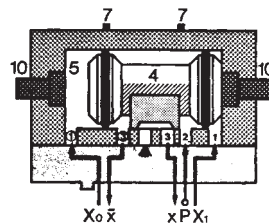

## Dimensions

81 523 205 - 81 523 608

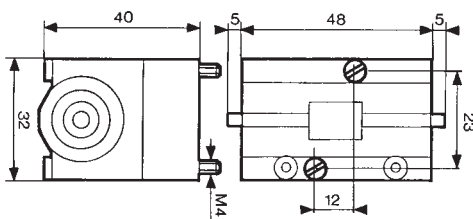

## Dimensions of logic and memory elements

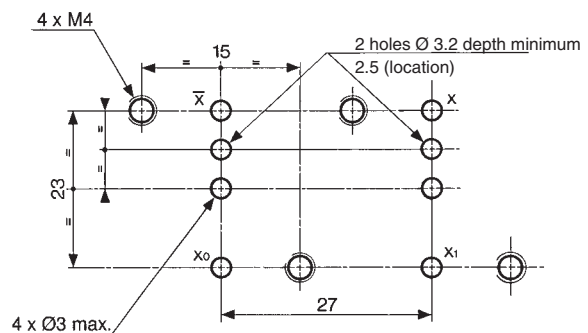

Viewed from above

To order an Ex product, you must complete the form on page 53.



# Ex Timers (with fixed timing)

FILE No. C.PN.HOM.00008.FR  
 INERIS No. 18410/05

Equipment intended for use in potentially explosive atmospheres conforming to Directive 94/9/EC

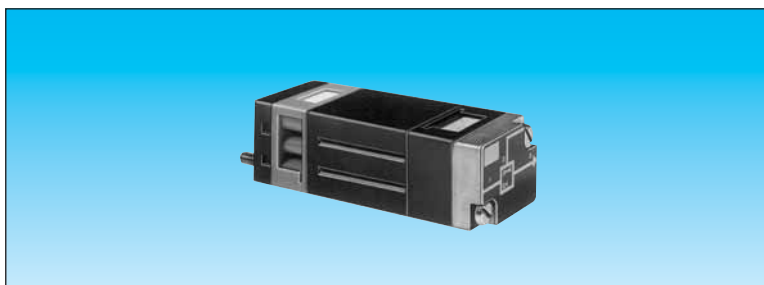

Version

81 503 543

Classification

Positive output

CE II 2 G D c IIB 60°C(T6) X

Symbol

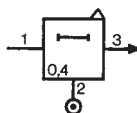

## Characteristics

Timing	s	0.4
Operating pressure	bar	2 → 8
Flow at 6 bars	NI/min	170
Orifice diameter	mm	2.7
Accuracy	%	± 5
Min. reset time	s	<0.1
Connection - On sub-base page 36-37		●
Operating temperature	°C	-5 +50
Mechanical life	operations	>10 <sup>7</sup>
Weight	g	106

Principle of operation  
 with positive output

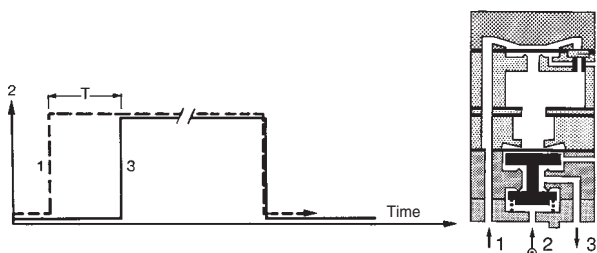

## Dimensions

81 503 543

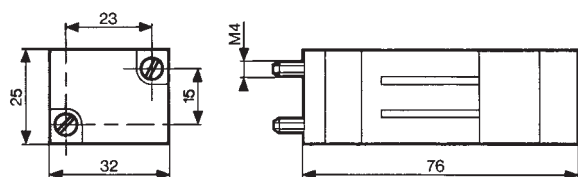

To order an Ex product, you must complete the form on page 53.

# Ex Timers (with adjustable timing)

FILE No. C.PN.HOM.00008.FR  
INERIS No. 18410/05

Equipment intended for use in potentially explosive atmospheres conforming to Directive 94/9/EC

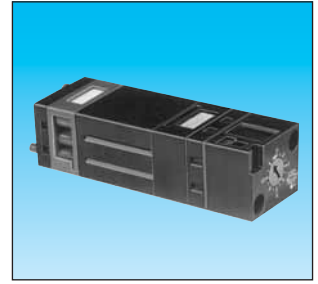
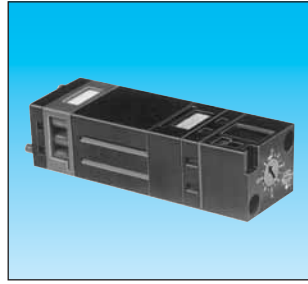
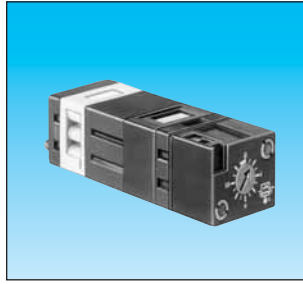

	81 503 728	81 506 714	81 503 729	81 506 721	81 503 731	81 506 727
Function positive	•	—	•	—	•	—
Function negative	—	•	—	•	—	•

Classification **CE II 2 G D c IIB 60°C(T6) X**

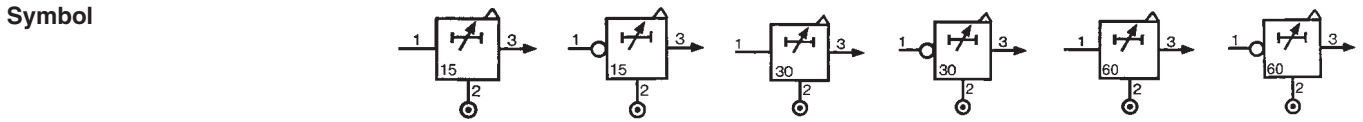

**Characteristics**

Timing	s	0.1 • 15	0.1 • 15	0.1 • 30	0.1 • 30	0.1 • 60	0.1 • 60
Operating pressure	bar	2 → 8	2 → 8	2 → 8	2 → 8	2 → 8	2 → 8
Flow at 6 bars	NI/min	170	170	170	170	170	170
Orifice diameter	mm	2.7	2.7	2.7	2.7	2.7	2.7
Accuracy	%	± 5	± 5	± 5	± 5	± 5	± 5
Min. reset time	s	<0.1	<0.1	<0.1	<0.1	<0.1	<0.1
Connection - On sub-base page 36-37		•	•	•	•	•	•
Operating temperature	°C	-5 +50	-5 +50	-5 +50	-5 +50	-5 +50	-5 +50
Mechanical life	operations	>10 <sup>7</sup>	>10 <sup>7</sup>	>10 <sup>7</sup>	>10 <sup>7</sup>	>10 <sup>7</sup>	>10 <sup>7</sup>
Weight	g	90	90	100	100	120	120

**Accessories**

Panel mounting adaptor		79 451 698	79 451 698	79 451 903	—	—	—
Weight	g	53	53	53	—	—	—

**Principle**  
The operation of these pneumatic timers is similar to that of electronic timers (circuit with capacitor/resistor)

**Principle of operation**  
with positive output      with negative output

**Timing by charging of reservoir**

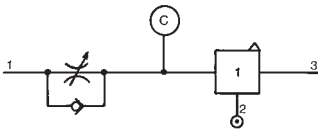

The reservoir fills via the flow restrictor until the switching point of the timer output is reached (positive or negative). The non-return valve allows the reservoir to be emptied rapidly for the next timing.

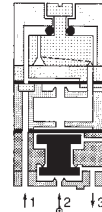
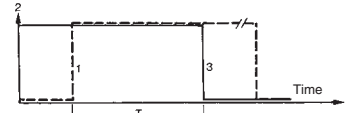
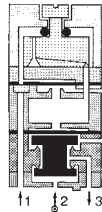
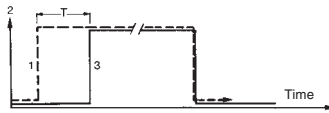

**Dimensions**

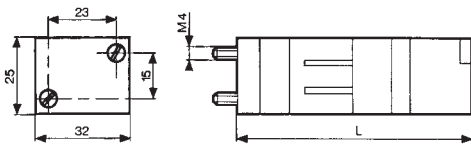

	L (mm)
81 503 728 - 81 506 714	78
81 503 729 - 81 506 721	92
81 503 731 - 81 506 727	125

**Adaptator 79 451 ...**

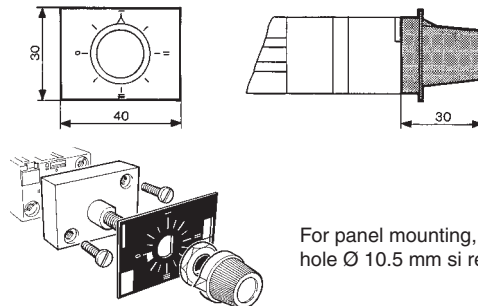

For panel mounting, a pre-drilled hole Ø 10.5 mm si required

To order an Ex product, you must complete the form on page 53.

FILE No. C.PN.HOM.00008.FR  
 INERIS No. 18410/05

**Equipment intended for use in potentially explosive atmospheres conforming to Directive 94/9/EC**

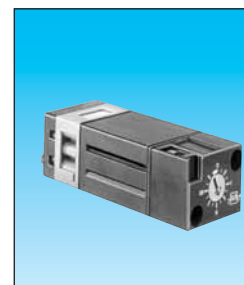

Single impulse generator	Fixed	81 507 543	—	—
	Adjustable	—	81 507 724	—
Adjustable frequency generator		—	—	81 506 945
Classification	CE II 2 G D c IIB 60°C(T6) X			

**Symbol**

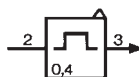

**Characteristics**

Timing	s	0.4	0.1 → 30	—
Frequency	Hz	—	—	0.02 → 8
Operating pressure	bar	2 → 8	2 → 8	2 → 8
Flow at 6 bars	Nl/min	170	170	170
Orifice diameter	mm	2.7	2.7	2.7
Accuracy	%	± 5	± 5	± 5
Min. reset time	s	<0.1	<0.1	<0.1
Connection - On sub-base page 36-37		●	●	●
Operating temperature	°C	-5 +50	-5 +50	-5 +50
Mechanical life	operations	>10 <sup>7</sup>	>10 <sup>7</sup>	>10 <sup>7</sup>
Weight	g	106	180	85

**Accessories**

Panel mounting adaptators	—	79 451 904	79 451 905
Weight (g)	—	53	53

**Principle of operation**

Single impulse generator

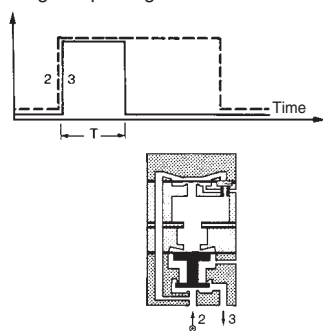

Adjustable impulse generator

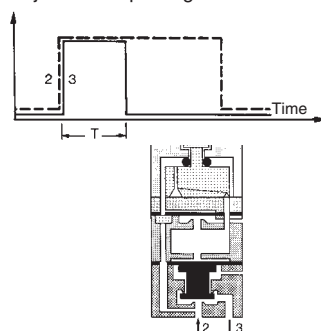

Frequency generator

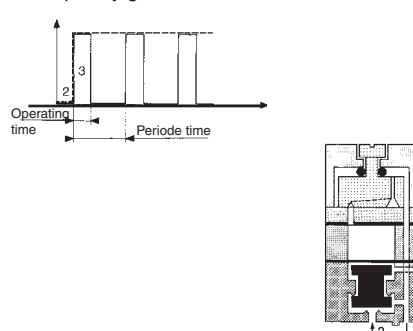

**Dimensions**

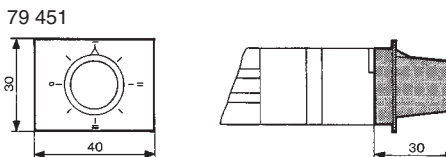
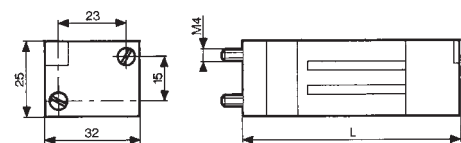

Part numbers	L (mm)
81 507 543	73
81 507 724	99
81 506 945	72

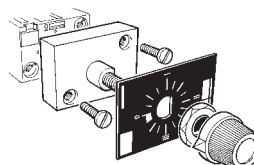

For panel mounting, a pre-drilled hole Ø 10.5 mm si required

To order an Ex product, you must complete the form on page 53.

# Ex Timers components

FILE No. C.PN.HOM.00008.FR  
INERIS No. 18410/05

Equipment intended for use in potentially explosive atmospheres conforming to Directive 94/9/EC

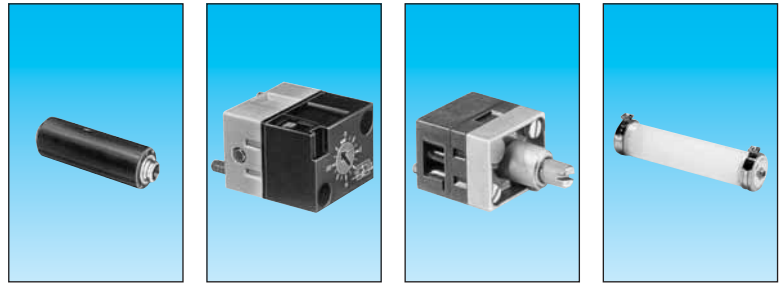

One-way in-line fixed flow restrictors	Flow at 4 bars Nm <sup>3</sup> /h	Ø orifice (mm)				
0.18 → 0.30	0.3	white	81 529 013	—	—	—
0.35 → 0.50	0.4	yellow	81 529 014	—	—	—
0.58 → 0.77	0.5	red	81 529 015	—	—	—
0.80 → 1.06	0.6	green	81 529 016	—	—	—
1.10 → 1.39	0.7	blue	81 529 017	—	—	—
1.45 → 1.65	0.8	grey	81 529 018	—	—	—
2.30 → 2.80	1	black	81 529 020	—	—	—
0.08 → 0.12	0.25	white	81 529 026	—	—	—
One-way adjustable flow restrictor				81 525 106	81 526 006	70 458 018
Capacity for timing	10 • 60 s					
Classification			CE II 2 G D c IIB 60°C(T6) X			CE II 2 G D c IIB 90°C(T5) X

## Symbol

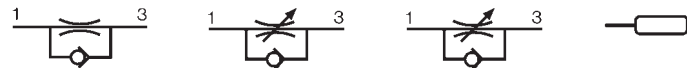

## Characteristics

Free flow	Nl/min	Depending on orifice	30	200	—
Orifice diameter	mm	Depending on orifice	0 → 0.5	0 → 1.7	—
Operating pressure	bars	1 → 8	1 → 8	2 → 8	—
Timing	s	—	—	—	10 → 60
Capacity	cm <sup>3</sup>	—	—	—	30
Connection	Sub-base page 36-37 Push-in connection for semi-rigid tubing (NFE 49100)	mm	Ø 4	—	Ø 4
Operating temperature	°C	-5 +50	-5 +50	-5 +50	-5 +50
Weight	g	8	60	70	40

## Connections

- For timing circuit
- One-way flow restrictor 81 525 1 - 81 529 0 (1)
- Reservoir 79 458 018 (2)
- Relay element 81 503 0 - 81 506 0 (3) page 28-29
- Sub-base page 36-37

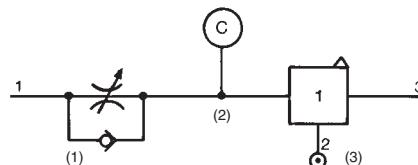

## Principle of operation

One-way with fixed flow

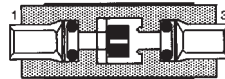

One-way with adjustable flow

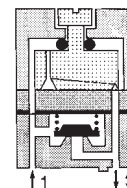

## Dimensions

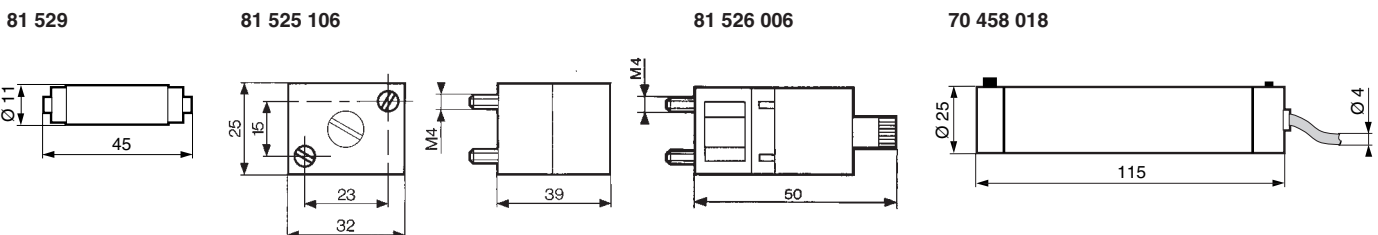

To order an Ex product, you must complete the form on page 53.

FILE No. C.PN.HOM.00008.FR  
 INERIS No. 18410/05

**Equipment intended for use in potentially explosive atmospheres conforming to Directive 94/9/EC**

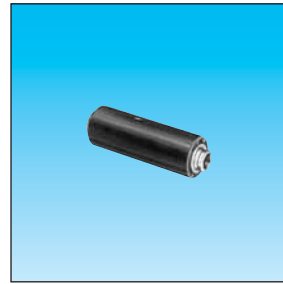
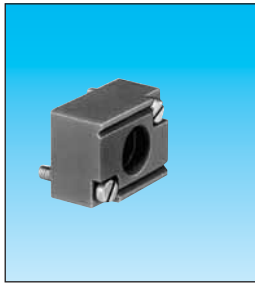

Plug element	81 520 602	—
In-line non-return	—	81 529 907
Classification	CE II 2 G D c IIB T6 X	CE II 2 G D c IIB 60°C(T6) X

**Symbol**

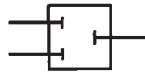

**Characteristics**

Operating pressure	bars	—	2 → 8
Flow at 6 bars	NI/min	—	200
Adjustable output pressure	bar	—	—
Connection	Sub-base page 36-37 Push-in connection for semi-rigid tubing (NFE 49100)	●	Ø 4
Operating temperature	°C	-5 +50	-5 +50
Weight	g	—	—

**Dimensions**

81 529 907



81 520 602

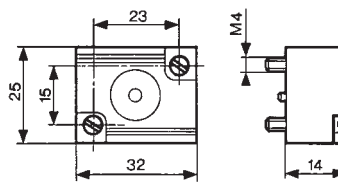



# Ex Sub-bases for logic elements and relays

FILE No. C.PN.HOM.00007.FR  
 INERIS No. 18408/05  
 for 81 532 111, 81 532 109  
 and 81 532 009

FILE No. C.PN.HOM.00004.FR  
 INERIS No. 17564/04  
 for 81 542 004

## Equipment intended for use in potentially explosive atmospheres conforming to Directive 94/9/EC

Two-hand start module (page 12)
Manostats - vacuostats (page 18-19)
Leak sensor and amplifier relays (page 20-21)
Logic elements AND Timers (page 29-31-32-33-34)
Regulator accessories (page 35)
Memory element (page 30)
Operating temperature °C
Electro-pneumatic miniature solenoid (page 43)

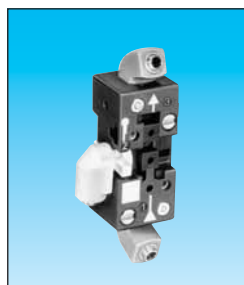

81 532 111
● 1
● 1
● 1
● 1
● 1
—
-5 +50
● 1

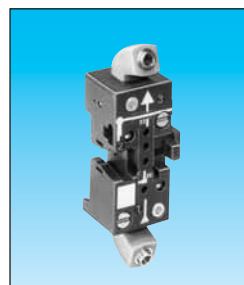

81 532 109
● 1
● 1
● 1
● 1
● 1
—
-5 +50
● 1

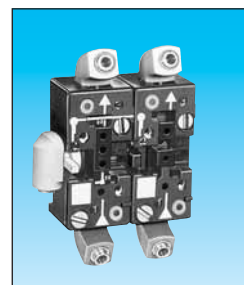

81 542 004
—
—
—
—
—
● 1
-5 +50
—

**NB: The number indicates the number of components mounted on the sub-base**

Classification	CE II 2 G D c IIB T6 X	CE II 2 G D c IIB T6 X
----------------	------------------------	------------------------

### Characteristics

Push-in connection for semi-rigid tubing Ø 4 mm (NFE 49100)	rotatable	rotatable	rotatable
Fixation	DIN rail 35 mm EN 50022	DIN rail 35 mm EN 50022	DIN rail 35 mm EN 50022
Weight g	56	52	95

### Connections elements and relays

#### Front connecting

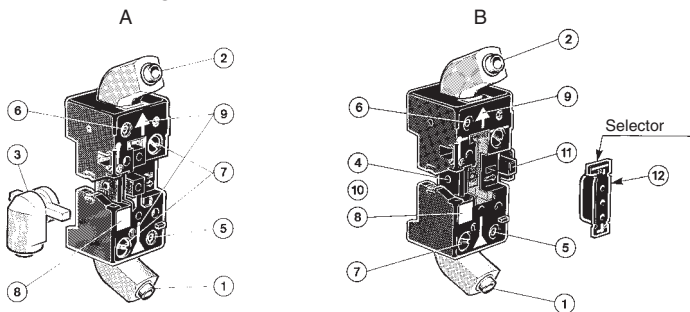

- A - Single sub-base or end base
- B - Associable sub-base
- 1 - Input port (green port 1)
- 2 - Output port (red port 3)
- 3 - Input/supply port (yellow port 2) Ø 4
- 4 - Input port integral to sub-base
- 5 - Input indicator (green)
- 6 - Output indicator (red)
- 7 - 1/4 turn screws
- 8 - Marking tag
- 9 - Arrow indicating flow direction
- 10 - Mounting tongue
- 11 - Mounting groove
- 12 - Selector

### Dimensions

81 532 109 - 81 532 111

81 542 004

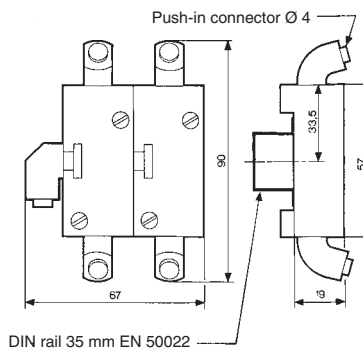
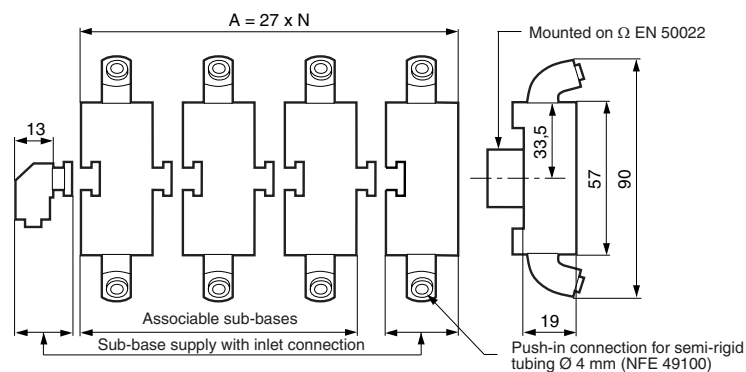

To order an Ex product, you must complete the form on page 53.

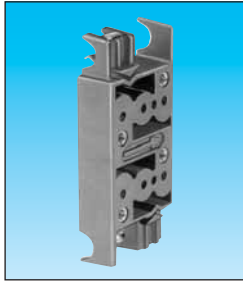
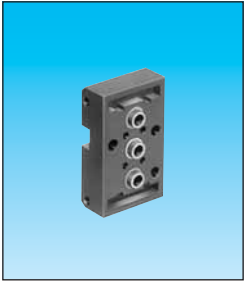

81 532 009

● 1
● 1
● 1
● 1
● 1
—
-5 +50
● 1

81 531 008

● 2
● 2
● 2
● 2
● 2
● 1
-5 +50
● 2

CE II 2 G D c IIB T6 X

rear

2 M4 screws

10

CE II 2 G D c IIB T6 X

rear

Clips for rails  
Ø 8 mm

35

**Memory element sub-base, front and rear connecting**

**Rear connection**

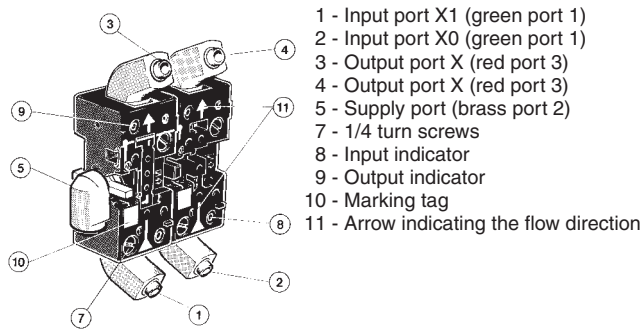

- 1 - Input port X1 (green port 1)
- 2 - Input port X0 (green port 1)
- 3 - Output port X (red port 3)
- 4 - Output port X (red port 3)
- 5 - Supply port (brass port 2)
- 7 - 1/4 turn screws
- 8 - Input indicator
- 9 - Output indicator
- 10 - Marking tag
- 11 - Arrow indicating the flow direction

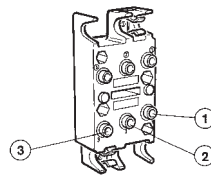

The modular system elements are fixed with two screws on the sub-base.

A locating device on each logic element prevents incorrect assembly.

The logic element is connected via the sub-base. This sub-base has 3 instant connections for connecting semi-rigid tubes with outer Ø 4.

- 1 - Input signal
- 2 - Signal port for passive logic elements, air supply for active logic elements.
- 3 - Output signal

81 532 009

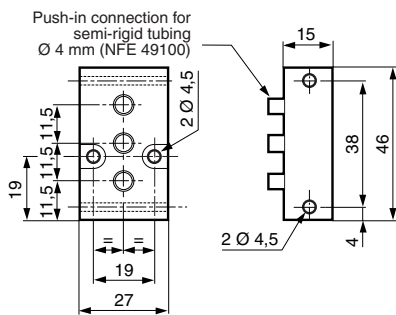

81 531 008

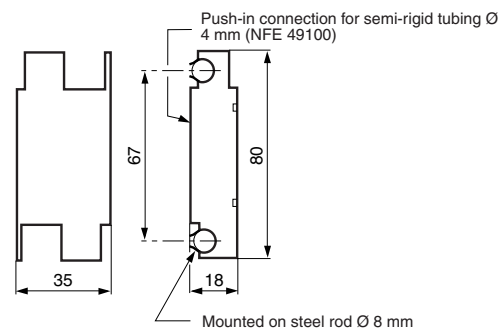

To order an product, you must complete the form on page 53.

# Ex Mounting accessories

FILE No. C.PN.HOM.00007.FR  
 INERIS No. 18408/05

**Equipment intended for use in potentially explosive atmospheres conforming to Directive 94/9/EC**

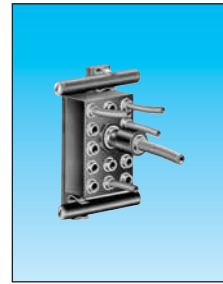
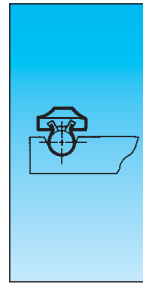
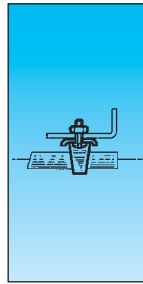
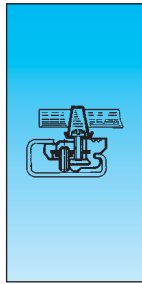
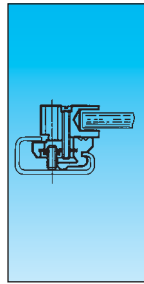

Mounting equipment

81 533 501  
Hole domino

81 533 001  
Clip domino

79 450 609  
Bar clips  
Ø 8

79 450 618  
Looking clip

—  
—

Supply manifold 13 outputs

—

—

—

—

81 536 804

Classification

CE II 2 G D c IIB T6 X

## Characteristics

Weight (g)	8 For mounting on the end of a zinc-coated mild steel rod Ø 8 mm on an asymmetrical DIN rail	4 For adjustable mounting on a zinc-coated mild steel rod Ø 8 mm on an asymmetrical DIN rail	80 Packet of 100 pieces	40 Packet of 100 pieces	80
Operating temperature °C	-5 +50	-5 +50	-5 +50	-5 +50	-5 +50

## Dimensions

81 536 804

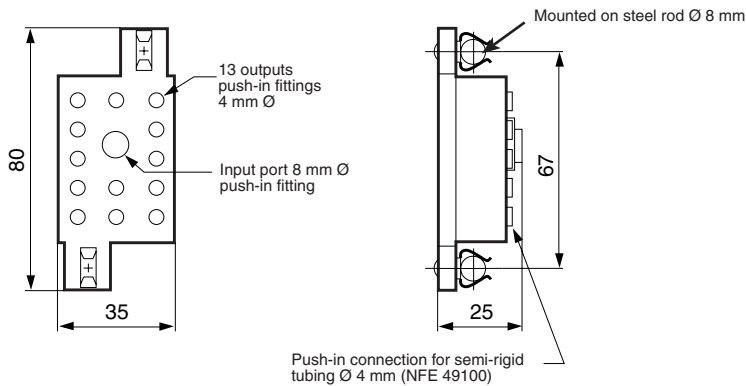

## Other information

Use Weidmuller plastic labels for marking components  
 part number FW 4734-6.

To order an Ex product, you must complete the form on page 53.

Компания «Океан Электроники» предлагает заключение долгосрочных отношений при поставках импортных электронных компонентов на взаимовыгодных условиях!

Наши преимущества:

- Поставка оригинальных импортных электронных компонентов напрямую с производств Америки, Европы и Азии, а так же с крупнейших складов мира;
- Широкая линейка поставок активных и пассивных импортных электронных компонентов (более 30 млн. наименований);
- Поставка сложных, дефицитных, либо снятых с производства позиций;
- Оперативные сроки поставки под заказ (от 5 рабочих дней);
- Экспресс доставка в любую точку России;
- Помощь Конструкторского Отдела и консультации квалифицированных инженеров;
- Техническая поддержка проекта, помощь в подборе аналогов, поставка прототипов;
- Поставка электронных компонентов под контролем ВП;
- Система менеджмента качества сертифицирована по Международному стандарту ISO 9001;
- При необходимости вся продукция военного и аэрокосмического назначения проходит испытания и сертификацию в лаборатории (по согласованию с заказчиком);
- Поставка специализированных компонентов военного и аэрокосмического уровня качества (Xilinx, Altera, Analog Devices, Intersil, Interpoint, Microsemi, Actel, Aeroflex, Peregrine, VPT, Syfer, Eurofarad, Texas Instruments, MS Kennedy, Miteq, Cobham, E2V, MA-COM, Hittite, Mini-Circuits, General Dynamics и др.);

Компания «Океан Электроники» является официальным дистрибьютором и эксклюзивным представителем в России одного из крупнейших производителей разъемов военного и аэрокосмического назначения «**JONHON**», а так же официальным дистрибьютором и эксклюзивным представителем в России производителя высокотехнологичных и надежных решений для передачи СВЧ сигналов «**FORSTAR**».



## JONHON

«**JONHON**» (основан в 1970 г.)

Разъемы специального, военного и аэрокосмического назначения:

(Применяются в военной, авиационной, аэрокосмической, морской, железнодорожной, горно- и нефтедобывающей отраслях промышленности)

«**FORSTAR**» (основан в 1998 г.)

ВЧ соединители, коаксиальные кабели, кабельные сборки и микроволновые компоненты:

(Применяются в телекоммуникациях гражданского и специального назначения, в средствах связи, РЛС, а так же военной, авиационной и аэрокосмической отраслях промышленности).



Телефон: 8 (812) 309-75-97 (многоканальный)

Факс: 8 (812) 320-03-32

Электронная почта: [ocean@oceanchips.ru](mailto:ocean@oceanchips.ru)

Web: <http://oceanchips.ru/>

Адрес: 198099, г. Санкт-Петербург, ул. Калинина, д. 2, корп. 4, лит. А