

**Microsemi**  
**MAX3670 Evaluation Kit**

### General Description

The MAX3670 evaluation kit (EV kit) is an assembled, surface-mount demonstration board that provides easy evaluation of the MAX3670 155MHz to 670MHz reference clock generator. The EV kit comes with external components and a 622.08MHz voltage-controlled crystal oscillator (VCXO).

### Component Suppliers

SUPPLIER	PHONE	FAX
AVX	843-448-9411	843-448-1943
Coilcraft	408-224-8566	408-224-6304
Murata	770-436-1300	770-436-3030
Vectron	1-88-VECTRON-1	1-888-PAX-VECTRON

### Features

- ◆ Fully Assembled and Tested
- ◆ 5.0V Operation

### Ordering Information

PART	TEMP RANGE	IC PACKAGE
MAX3670EVKIT	-40°C to +85°C	32 QFN-EP*

\*Exposed pad

### Electrical Component List

DESIGNATION	QTY	DESCRIPTION
C1, C4–C9, C12, C15, C16, C20, C22, C31–C35	17	0.1 $\mu$ F $\pm$ 10% ceramic capacitors (0402)
C1A, C1B	2	0.015 $\mu$ F $\pm$ 10% ceramic capacitors (0805)
C2, C3, C3A, C10, C11, C14, C19, C21, C23–C27, C29, C30	0	Open
C3B	1	6800pF $\pm$ 10% ceramic capacitor (0805)
C13	1	1 $\mu$ F $\pm$ 10% ceramic capacitor (0805)
C17	1	10 $\mu$ F $\pm$ 10% tantalum capacitor
J1–J8, J11	9	SMA connectors (edge-mount)
J9, J10, J12, J15, J16	0	Open
J13, J14	2	Test points
JU1–JU5, JU7–JU10	9	1 $\times$ 3-pin headers
JU1–JU13	13	Shunts
JU6, JU11, JU12, JU13	4	1 $\times$ 2-pin headers
L1, L3, L4	0	Open
L2	1	56nH inductor

DESIGNATION	QTY	DESCRIPTION
R1, R11, R12, R13, R18–R21, R23, R24, R26, R27, R29, R31	0	Open
R1A, R1B	2	200k $\Omega$ $\pm$ 1% resistors (0402)
R2	1	100 $\Omega$ $\pm$ 1% resistor (0402)
R3, R4, R6, R8, R10, R16, R17	7	332 $\Omega$ $\pm$ 1% resistors (0402)
R5, R7, R9, R14, R15, R22, R28, R30, R32	9	0 $\Omega$ resistors (0402)
U1	1	MAX3670EGJ 32 QFN-EP
Y1	1	622.08MHz voltage-controlled SAW oscillator Vectron VS500A622
None	1	MAX3670 EV kit circuit board
None	1	MAX3670 EV kit data sheet
None	1	MAX3670 data sheet

**Evaluates: MAX3670**

# MAX3670 Evaluation Kit

## Quick Start

- 1) Install shunts JU1, JU4, JU5, JU7, and JU10 between pins 1 and 2.
- 2) Install shunts JU11, JU12, and JU13.
- 3) Open shunts JU3 and JU6.
- 4) Install shunts JU2, JU8, and JU9 between pins 2 and 3.
- 5) Connect a 5V power supply to VCCA.
- 6) Connect ground to GND.
- 7) Apply a 1Vp-p differential clock input at 622.08MHz to REFCLK+ and REFCLK-.
- 8) Monitor MOUT+ and MOUT- with a 50Ω system. A 622.08MHz clock signal appears on the oscilloscope.

## Adjustment and Control Descriptions\*

COMPONENT	NAME	FUNCTION
JU1	GSEL1	Sets the phase-detector gain ( $K_{PD}$ ) and the frequency divider ratio ( $N_2$ ). Shunting between pins 1 and 2 sets to GND. Shunting between pins 2 and 3 sets to $V_{CC}$ (see Table 1).
JU2	GSEL2	Sets the phase-detector gain ( $K_{PD}$ ) and the frequency divider ratio ( $N_2$ ). Shunting between pins 1 and 2 sets to GND. Shunting between pins 2 and 3 sets to $V_{CC}$ (see Table 1).
JU3	GSEL3	Sets the phase-detector gain ( $K_{PD}$ ) and the frequency divider ratio ( $N_2$ ). Shunting between pins 1 and 2 sets to GND. Shunting between pins 2 and 3 sets to $V_{CC}$ (see Table 1).
JU4	RSEL	Sets the predivider ratio for the reference input clock. Shunting between pins 1 and 2 sets to GND. Shunting between pins 2 and 3 sets to $V_{CC}$ (see Table 2).
JU5	VSEL	Sets the predivider ratio for the VCO input clock. Shunting between pins 1 and 2 sets to GND. Shunting between pins 2 and 3 sets to $V_{CC}$ (see Table 3).
JU6	—	Open when VCO is activated. Closed when VCO is disabled.
JU7	COMP	Sets the internal compensation of the op amp. Shunting between pins 1 and 2 sets the compensation to GND. Shunting between pins 2 and 3 sets the compensation to $V_{CC}$ .
JU8	PSEL2	Sets the output clock divider. Shunting between pins 1 and 2 sets to GND. Shunting between pins 2 and 3 sets to $V_{CC}$ (see Table 4).
JU9	PSEL1	Sets the output clock divider. Shunting between pins 1 and 2 sets to GND. Shunting between pins 2 and 3 sets to $V_{CC}$ (see Table 4).
JU10	POLAR	Sets the polarity of the op amp. Shunting between pins 1 and 2 sets the polarity to GND. Shunting between pins 2 and 3 sets the polarity to $V_{CC}$ .

\*See Quick Start first.

# MAX3670 Evaluation Kit

Evaluates: MAX3670

## Adjustment and Control Descriptions (continued)

COMPONENT	NAME	FUNCTION
JU11	—	Ensure that shunt is installed.
JU12	—	Ensure that shunt is installed.
JU13	—	Ensure that shunt is installed.

**Table 1. Gain Logic Pin Setup**

INPUT PIN GSEL1	INPUT PIN GSEL2	INPUT PIN GSEL3	K <sub>PD</sub> (μA/UI)	DIVIDER RATIO N
V <sub>CC</sub>	V <sub>CC</sub>	V <sub>CC</sub>	20	1
OPEN	V <sub>CC</sub>	V <sub>CC</sub>	20	2
GND	V <sub>CC</sub>	V <sub>CC</sub>	20	4
V <sub>CC</sub>	OPEN	V <sub>CC</sub>	20	8
OPEN	OPEN	V <sub>CC</sub>	20	16
GND	OPEN	V <sub>CC</sub>	20	32
V <sub>CC</sub>	GND	V <sub>CC</sub>	20	64
OPEN	GND	V <sub>CC</sub>	20	128
GND	GND	V <sub>CC</sub>	20	256
V <sub>CC</sub>	V <sub>CC</sub>	GND	20	512
OPEN	V <sub>CC</sub>	GND	20	1024
V <sub>CC</sub>	V <sub>CC</sub>	OPEN	5	1
OPEN	V <sub>CC</sub>	OPEN	5	2
GND	V <sub>CC</sub>	OPEN	5	4
V <sub>CC</sub>	OPEN	OPEN	5	8
OPEN	OPEN	OPEN	5	16
GND	OPEN	OPEN	5	32
V <sub>CC</sub>	GND	OPEN	5	64
OPEN	GND	OPEN	5	128
GND	GND	OPEN	5	256
V <sub>CC</sub>	OPEN	GND	5	512
OPEN	OPEN	GND	5	1024

**Table 2. Reference Clock Divider**

INPUT PIN RSEL	REFERENCE CLOCK INPUT FREQ (MHz)	DIVIDER RATIO (N <sub>3</sub> )	PREDIVIDER OUTPUT FREQ (MHz)
V <sub>CC</sub>	77.76	1	77.76
OPEN	155.52	2	77.76
GND	622.08	8	77.76

**Table 3. VCO Clock Divider**

INPUT PIN VSEL	VCO CLOCK INPUT FREQ (MHz)	DIVIDER RATIO (N <sub>1</sub> )	PREDIVIDER OUTPUT FREQ (MHz)
V <sub>CC</sub>	77.76	1	77.76
OPEN	155.52	2	77.76
GND	622.08	8	77.76

**Table 4. Optional Clock Output Divider**

INPUT PIN PSEL1	INPUT PIN PSEL2	VCO TO POUT DIVIDE RATIO
V <sub>CC</sub>	V <sub>CC</sub>	1
GND	V <sub>CC</sub>	2
V <sub>CC</sub>	GND	4
GND	GND	8

# MAX3670 Evaluation Kit

Evaluates: MAX3670

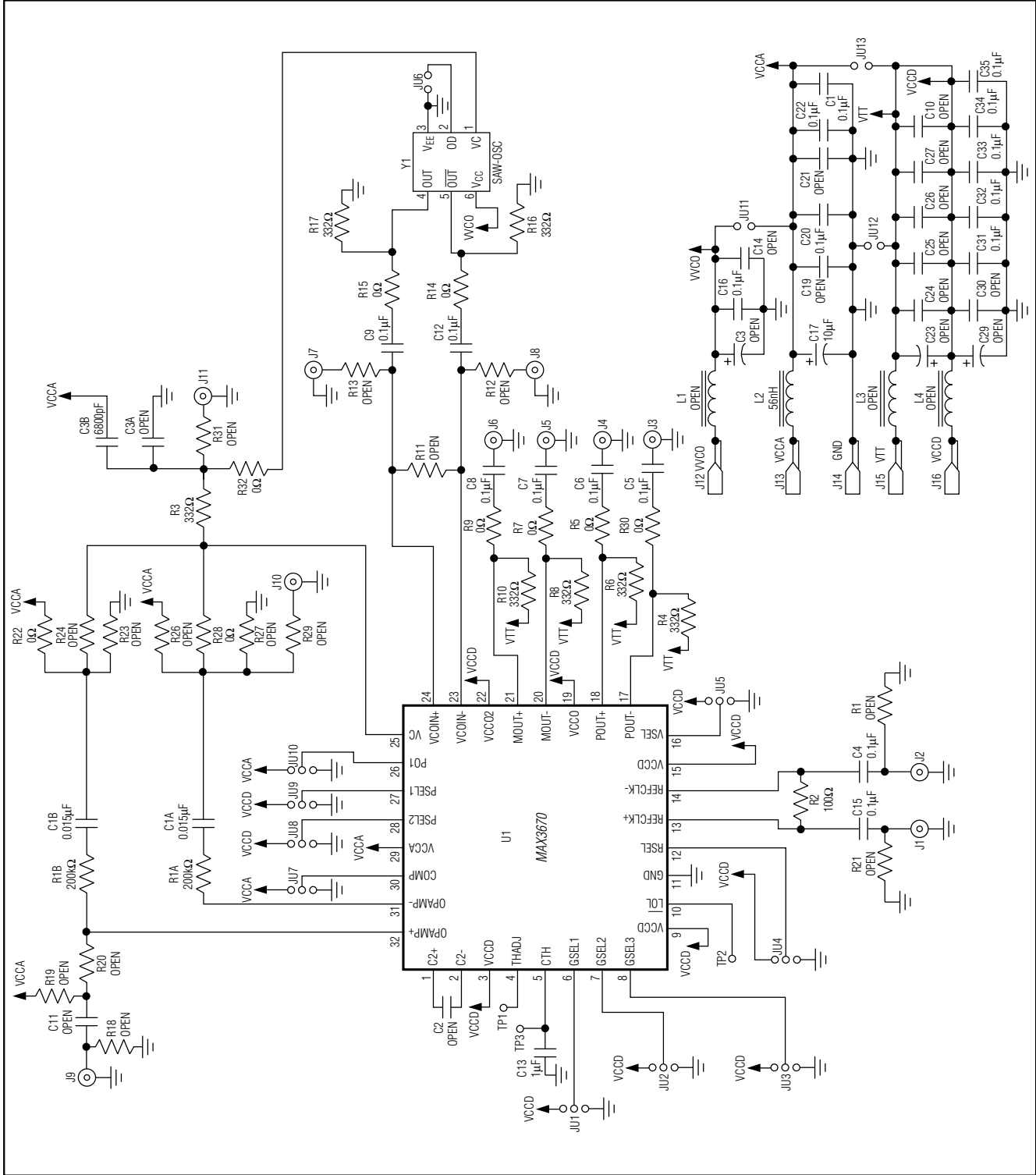

Figure 1. MAX3670 EV Kit Schematic

# MAX3670 Evaluation Kit

Evaluates: MAX3670

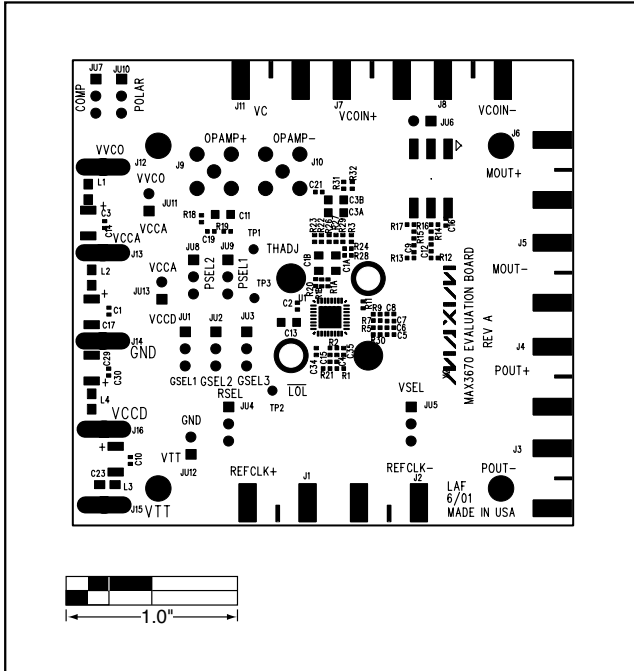

Figure 2. MAX3670 EV Kit Component Placement Guide—Component Side

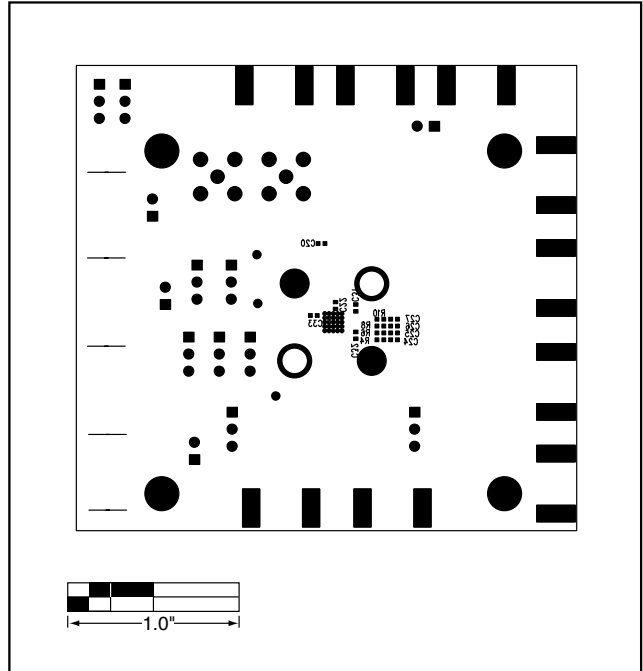

Figure 3. MAX3670 EV Kit Component Placement Guide—Solder Side

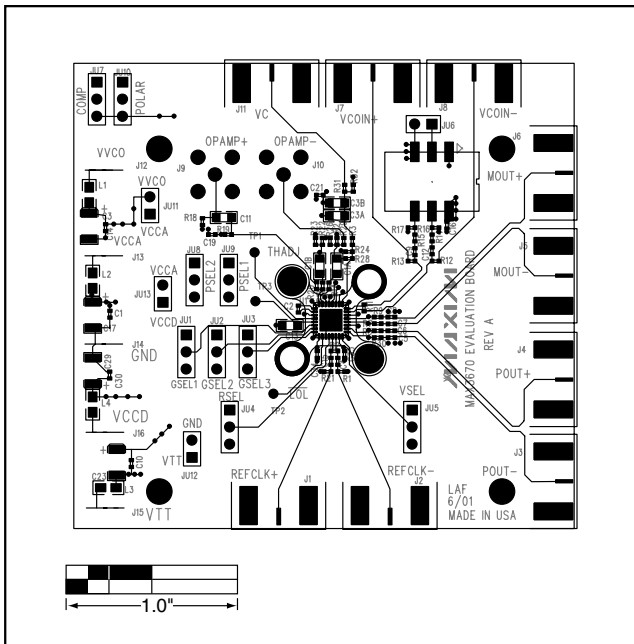

Figure 4. MAX3670 EV Kit PC Board Layout—Component Side

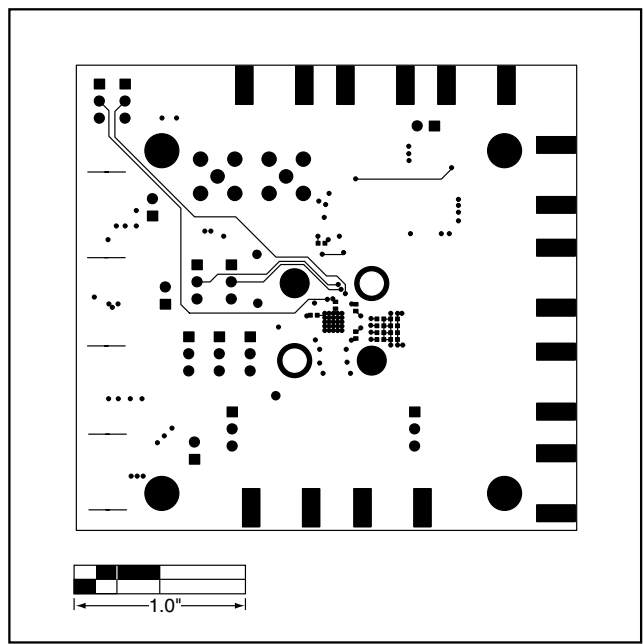

Figure 5. MAX3670 EV Kit PC Board Layout—Solder Side

# MAX3670 Evaluation Kit

**Evaluates: MAX3670**

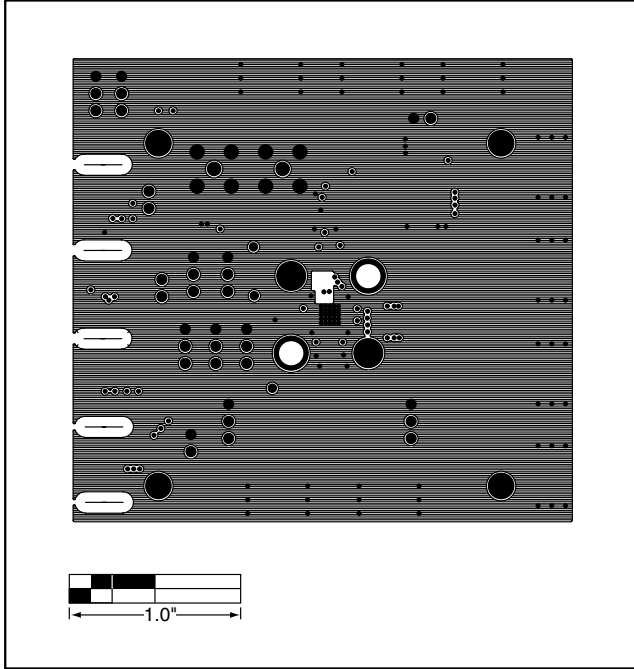

Figure 6. MAX3670 EV Kit PC Board Layout—Ground Plane

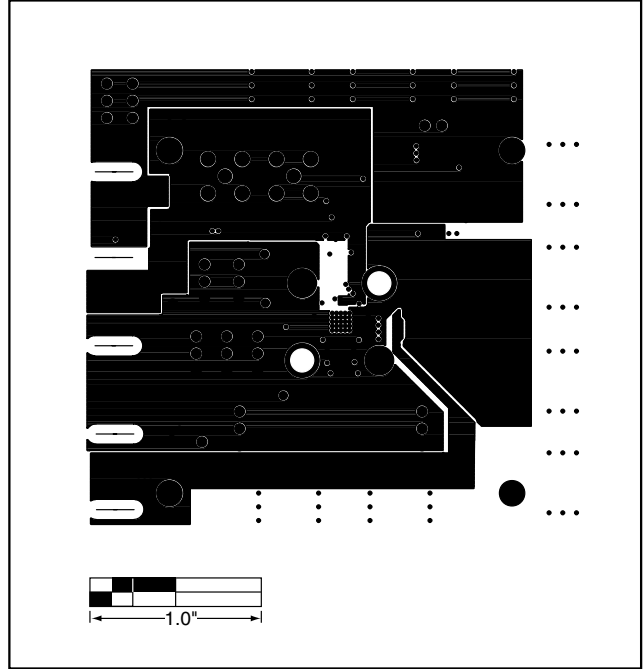

Figure 7. MAX3670 EV Kit PC Board Layout—Power Plane



**Microsemi Corporate Headquarters**  
One Enterprise, Aliso Viejo CA 92656 USA  
Within the USA: +1 (949) 380-6100  
Sales: +1 (949) 380-6136  
Fax: +1 (949) 215-4996

Microsemi Corporation (NASDAQ: MSCC) offers a comprehensive portfolio of semiconductor solutions for: aerospace, defense and security; enterprise and communications; and industrial and alternative energy markets. Products include high-performance, high-reliability analog and RF devices, mixed signal and RF integrated circuits, customizable SoCs, FPGAs, and complete subsystems. Microsemi is headquartered in Aliso Viejo, Calif. Learn more at [www.microsemi.com](http://www.microsemi.com).

---

© 2012 Microsemi Corporation. All rights reserved. Microsemi and the Microsemi logo are trademarks of Microsemi Corporation. All other trademarks and service marks are the property of their respective owners.

Компания «Океан Электроники» предлагает заключение долгосрочных отношений при поставках импортных электронных компонентов на взаимовыгодных условиях!

Наши преимущества:

- Поставка оригинальных импортных электронных компонентов напрямую с производств Америки, Европы и Азии, а так же с крупнейших складов мира;
- Широкая линейка поставок активных и пассивных импортных электронных компонентов (более 30 млн. наименований);
- Поставка сложных, дефицитных, либо снятых с производства позиций;
- Оперативные сроки поставки под заказ (от 5 рабочих дней);
- Экспресс доставка в любую точку России;
- Помощь Конструкторского Отдела и консультации квалифицированных инженеров;
- Техническая поддержка проекта, помощь в подборе аналогов, поставка прототипов;
- Поставка электронных компонентов под контролем ВП;
- Система менеджмента качества сертифицирована по Международному стандарту ISO 9001;
- При необходимости вся продукция военного и аэрокосмического назначения проходит испытания и сертификацию в лаборатории (по согласованию с заказчиком);
- Поставка специализированных компонентов военного и аэрокосмического уровня качества (Xilinx, Altera, Analog Devices, Intersil, Interpoint, Microsemi, Actel, Aeroflex, Peregrine, VPT, Syfer, Eurofarad, Texas Instruments, MS Kennedy, Miteq, Cobham, E2V, MA-COM, Hittite, Mini-Circuits, General Dynamics и др.);

Компания «Океан Электроники» является официальным дистрибьютором и эксклюзивным представителем в России одного из крупнейших производителей разъемов военного и аэрокосмического назначения «JONHON», а так же официальным дистрибьютором и эксклюзивным представителем в России производителя высокотехнологичных и надежных решений для передачи СВЧ сигналов «FORSTAR».



## JONHON

«JONHON» (основан в 1970 г.)

Разъемы специального, военного и аэрокосмического назначения:

(Применяются в военной, авиационной, аэрокосмической, морской, железнодорожной, горно- и нефтедобывающей отраслях промышленности)

«FORSTAR» (основан в 1998 г.)

ВЧ соединители, коаксиальные кабели, кабельные сборки и микроволновые компоненты:

(Применяются в телекоммуникациях гражданского и специального назначения, в средствах связи, РЛС, а так же военной, авиационной и аэрокосмической отраслях промышленности).



Телефон: 8 (812) 309-75-97 (многоканальный)

Факс: 8 (812) 320-03-32

Электронная почта: [ocean@oceanchips.ru](mailto:ocean@oceanchips.ru)

Web: <http://oceanchips.ru/>

Адрес: 198099, г. Санкт-Петербург, ул. Калинина, д. 2, корп. 4, лит. А