

System Power Supply for TV Series

FET Controller Type 3ch System Power Supply ICs



BD8629FS

No.09034EAT07

●Description

BD8629FS has realized the high performance and reliability required as a power supply for thin-screen TV.

With built-in FET 1ch current mode control, the DC/DC Converter series has the advantage of high-speed load response and wide phase margin.

Due to the high-speed load response, it is most suitable for TV-purpose processors with increasingly high performance, and due to the wide phase margin it leaves a good margin for board pattern & constant setting and so facilitates its application design.

As a high-reliability design, it has various built-in protection circuits (overcurrent protection, output voltage abnormal protection, thermal protection, and off-latch function at the time of abnormality etc.), therefore as an advantage it does not easily damage in every possible abnormal condition such as all-pin short circuit test etc. and hence most suitable for thin-screen TV which requires the high reliability.

●Features

- 1) High efficiency in all load area
- 2) 2.0A output current
- 3) Low RDS(ON) internal switches (PchMOS:170mΩ, NchMOS:130mΩ)
- 4) ±1% reference voltage accuracy
- 5) Programmable frequency : 250kHz-1MHz
- 6) Terminal RT OPEN/SHORT detecting function
- 7) Over current protection function
- 8) Output over voltage/low voltage protection function (over : FB > VREF +60mV , low : FB < VREF -60mV)
- 9) Timer off latch function in abnormal circumstances
- 10) Thermal shutdown function
- 11) Under voltage protection
- 12) Soft start/start delay circuit
- 13) Soft start time out function
- 14) SSOP-A16 package

●Electrical characteristic

(Unless otherwise noted Ta=25°C, VIN=5.6V)

Parameter	Symbol	Specification value			UNIT	Condition
		MIN	TYP	MAX		
VIN supply current (operating)	I _{Q_active}	-	1.3	2.0	mA	V _{FB} = 0.83V, V _{FC} = 1V
VIN supply current (standby)	I _{Q_stby}	-	350	700	μA	V _{EN} = 0V
Reference voltage (VREF)	V _{REF}	0.792	0.8	0.808	V	
Output rise detection voltage	V _{OVP}	30	60	90	mV	Monitoring FB terminal
Output decrease detection voltage	V _{LVP}	-90	-60	-30	mV	Monitoring FB terminal
Terminal PDET output current	I _{PDET}	1	-	-	mA	V _{PDET} < 0.5V
Oscillation frequency	f _{OSC}	500	550	600	kHz	R _{OSC} = 220kΩ
Pch FET ON resistance	R _{PFET}	-	170	240	mΩ	I _{SW} = 1A
Nch FET ON resistance	R _{NFET}	-	130	200	mΩ	I _{SW} = -1A
UVLO voltage	V _{UVLO}	3.8	4.0	4.2	V	
SW leak current	I _{LSW}	-	0	1	μA	V _{EN} = 0V, V _{IN} = 6V
EN terminal H threshold voltage	V _{ENH}	2.0	-	-	V	
EN terminal L threshold voltage	V _{ENL}	-	-	0.5	V	
SS/DELAY terminal source current	I _{SSSO}	2	4	6	μA	

V_{FB}:FB terminal voltage, V_{EN}:EN terminal voltage, V_{FC}:FC terminal voltage, V_{PDET}: PDET terminal voltage
 Current capability should not exceed Pd.

Permissible loss

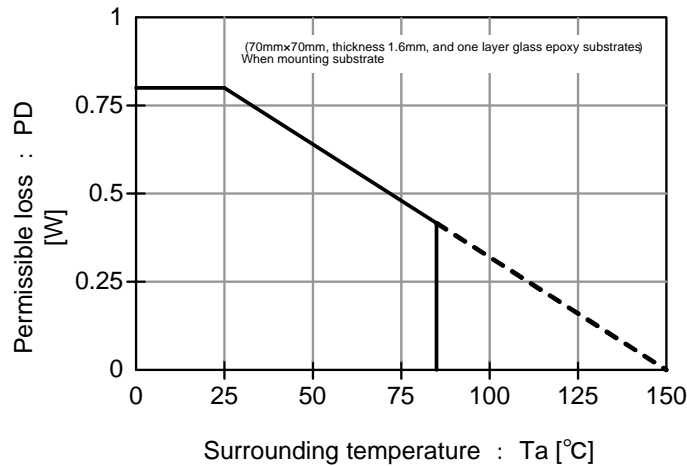

Fig. 1 heat decrease curve

●Block Diagram

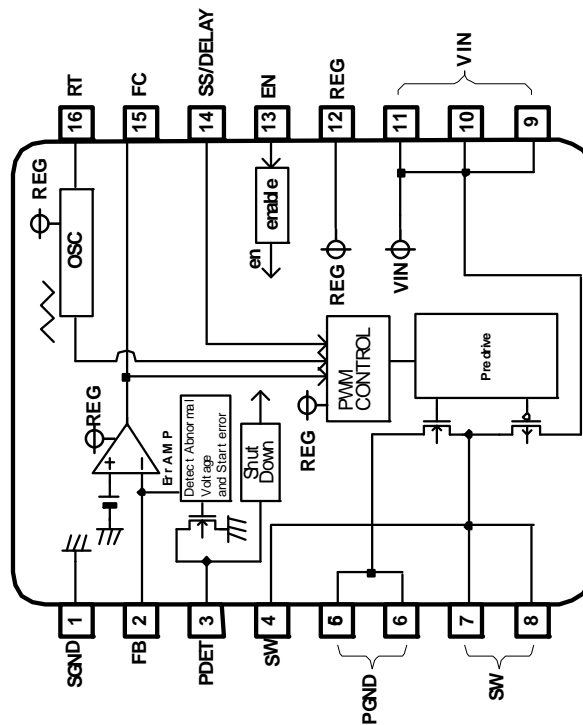

Fig.2 Block diagram

● Pin description

No.	Symbol	Description	Explanation
1	SGND	Signal GND terminal	Small signal system GND
2	FB	Feed back terminal	Output voltage detection
3	PDET	Off latch signal output	Reset output
4	SW	Output terminal	Switching output
5	PGND	Power GND terminal	GND for power MOSFET
6	PGND		
7	SW	Output terminal	Power Mos output
8	SW		
9	VIN	Power supply input terminal	Power supply input. The decoupling is done to PGND
10	VIN		
11	VIN		
12	REG	Internal regulator	Internal regulator
13	EN	Enable input	ON/OFF control for device operation
14	SS/DELAY	Soft start adjustment capacity connection terminal	The soft start time is adjusted with the connected capacitor
15	FC	Error amplifier output	Error amplifier phase compensation point
16	RT	Frequency adjustment resistance connection terminal	The switching frequency is set by the connected resistance

●Pin equivalence circuit diagram

No.	Symbol	Explanation	Terminal equivalent circuit diagram
1	SGND	GND (connected 0V)	
2	FB	Output voltage detection terminal	
3	PDET	Off latch signal output terminal	
4,7,8	SW	Output terminal	
5,6	PGND	Power GND (Same voltage as SGND)	
9,10,11	VIN	Power supply input terminal	

No.	Symbol	Explanation	Terminal equivalent circuit diagram
12	REG	Internal regulator output terminal	
13	EN	Enable terminal	

No.	Symbol	Explanation	Terminal equivalent circuit diagram
14	SS	Soft start time adjustment terminal	<p>The diagram shows the internal circuitry connected to the SS terminal. It features a network of resistors and diodes. A central node, labeled 14, is connected to VIN through a diode and to ground through another diode. There are also resistors connected to VIN and ground, and a diode connected to ground.</p>
15	FC	Error amplifier compensation terminal	<p>The diagram shows the internal circuitry connected to the FC terminal. It includes a network of resistors, capacitors, and diodes. A central node, labeled 15, is connected to VIN through a diode and to SGND through another diode. There are also resistors connected to VIN and SGND, and a diode connected to PGND.</p>
16	RT	Oscillator frequency adjustment terminal	<p>The diagram shows the internal circuitry connected to the RT terminal. It features a network of resistors and diodes. A central node, labeled 16, is connected to VIN through a diode and to SGND through another diode. There are also resistors connected to VIN and SGND.</p>

● **Operation description**

Enable control

The device can be controlled ON/OFF by EN terminal (13 pin) voltage.
An internal circuit starts when VEN reaches 1.4V.

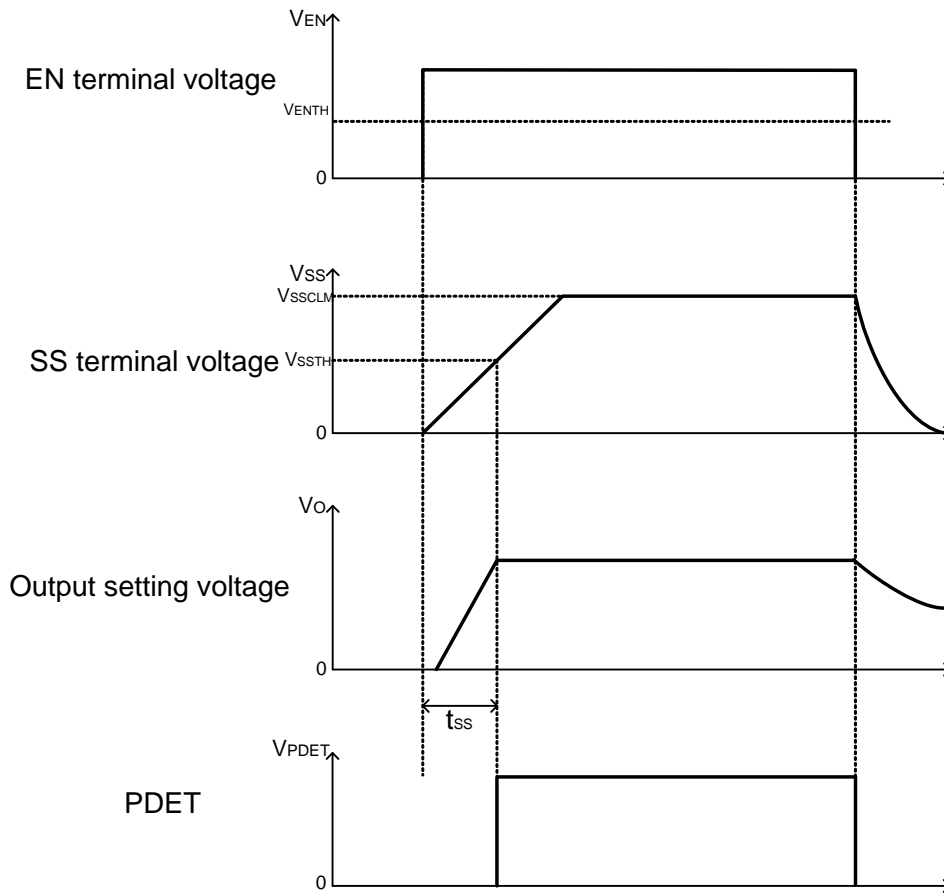

Fig. 3 ON/OFF transition wave form in EN controlling

Soft start time set function

As for BD8629FS, output can do soft start without overshoot by charging soft start capacity (CSS) connected between SS and SGND terminal.

Also, soft start time (t_{ss}) can be set by setting soft start capacity (CSS) arbitrarily.

OSC oscillation frequency setting function

The output oscillation frequency can be set by connecting resistance between terminal RT (16 pins) and SGND (range = 250kHz - 1MHz)

The relation between RT terminal resistance and the oscillation frequency follows Fig.4.

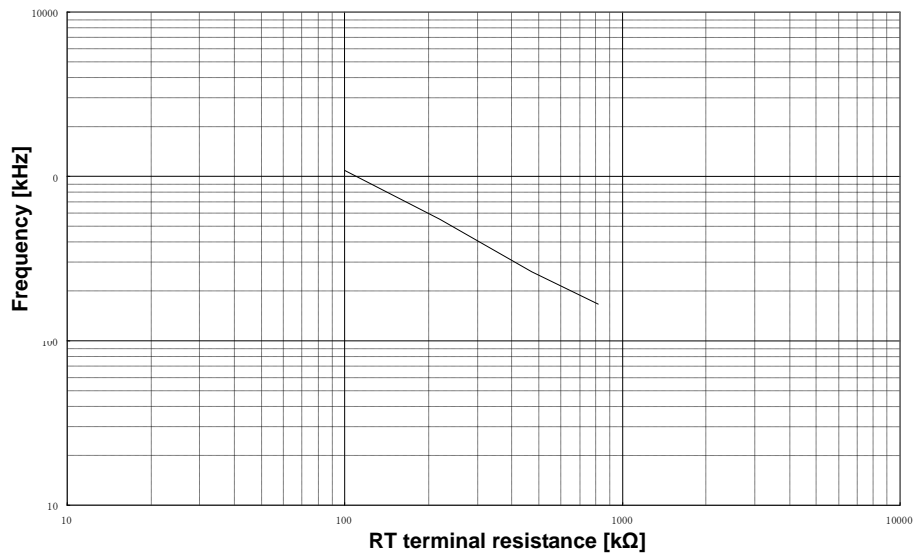

Fig. 4 RT resistance-oscillation frequency

● **Protection function**

Protection circuit is effective for destruction prevention due to accident so that avoid using under continuous protection operation.

Low voltage protection function (LVP)

The voltage of the terminal FB (2 pins) is compared with internal reference voltage VREF.

If FB terminal voltage falls below $V_{LVP}(= VREF - 60mV)$ and the state continues for 500us, output changes to low voltage and the state is fixed. In that case , PDET (3pin) output changes to L.

Table 1 output low voltage protection function

EN terminal	SS terminal	FB terminal	Low voltage protection function	Low voltage protection operation
$>V_{IHEN}$	$>1.4V(typ)$	$<V_{LVP}$	Effective	ON
		$>V_{LVP}$		OFF
	$<1.4V(typ)$	-	Invalidity	OFF
$<V_{ILEN}$	-	-	Invalidity	OFF

* Low voltage protection function is available when SS terminal voltage becomes more than 1.4V (typ) in the transition to ON control (during soft start).

Over voltage protection function(OVP)

The voltage of the terminal FB is compared with internal reference voltage VREF.

If FB terminal voltage is over $V_{ovp}(=VREF + 60mV)$ and the state is continues for 500usec, output changes to low voltage and the state is fixed.

Table 2 output overvoltage protection function

EN terminal	SS terminal	FB terminal	Over voltage protection function	Over voltage protection operation
$>V_{IHEN}$	$>1.4V(typ)$	$>V_{OVP}$	Effective	ON
		$<V_{OVP}$		OFF
	$<1.4V(typ)$	-	Invalidity	OFF
$<V_{ILEN}$	-	-	Invalidity	OFF

* Over voltage protection function is available when SS terminal voltage becomes more than 1.4V (typ) in the transition to ON control (during soft start).

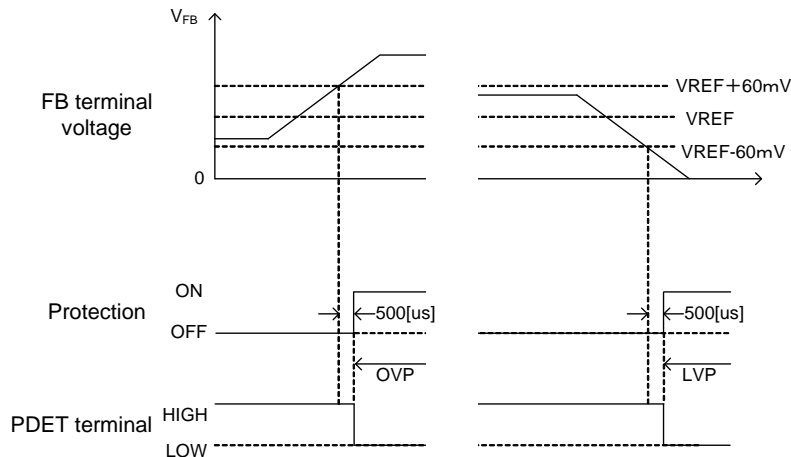

Fig. 5 Output voltage error detection range

Under voltage lock out protection (UVLO)

As for BD8629FS, the power-supply voltage decrease detection protection circuit is built in. If the input voltage decrease below the UVLO voltage (4.0V typ), the device state changes to the standby mode (Moreover, to prevent the chattering of the output) hysteresis width of 300mV(typ) has been installed in the UVLO cancel voltage.

RT terminal open/short protection function (RTO/RTS)

RT terminal opening/short protection function prevent the clock from abnormal oscillation. If RT terminal open/short protection function is detected, output voltage changes to low level and is fixed.

Terminal RT opening/short protection function is always effective after the power supply start-up. Terminal RT opening/short protection function is available if the state continue for 500usec, abnormal detection operates when the state continues about 500µsec(typ).

Soft start time-out function

If VSS doesn't exceed VSSTH within 64msec (typ) since a soft start began, BD8629FS controls an off latch. Vo is fixed in a low level.

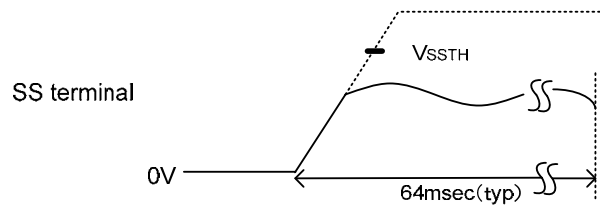

Fig. 6 Soft start time-out

Error detection (off latch) release method

BD8629FS enters the state of an off latch when the protection function operates. To release the off latch state, EN terminal voltage should be changed to low level once time.

Thermal shut down function

Thermal shut down circuit (TSD circuit) is built into BD8629FS. When the temperature of the chip exceeds $T_{jmax}=175$, the DC/DC converter is fixed in a low voltage.

TSD function is aimed to shut down IC from thermal reckless driving under an abnormal state to exceed $T_{jmax}=175$. It aims at neither protection nor the guarantee of the set. Therefore, please do not use this function to protect the set.

Over current protection function

The over current protection function has been achieved by limiting the current that flows on high side MOSFET. The current is controlled in every one cycle of the switching frequency. When an abnormal state continues for about 500µsec(typ), the output is fixed in a low level.

●Ordering part number

B	D
---	---

Part No.

8	6	0	1
---	---	---	---

Part No.

F	S
---	---

Package

FS: SSOP-A16

E	2
---	---

Packaging and forming specification

E2: Embossed tape and reel

SSOP-A16

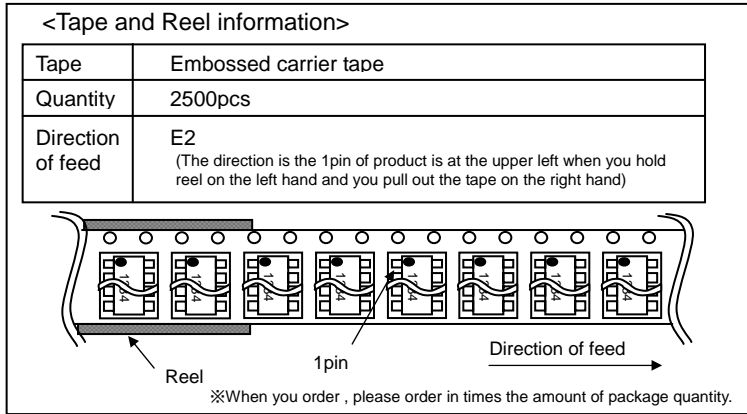
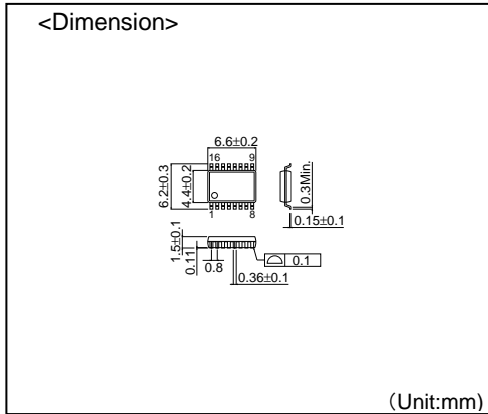

Notes

No copying or reproduction of this document, in part or in whole, is permitted without the consent of ROHM Co.,Ltd.

The content specified herein is subject to change for improvement without notice.

The content specified herein is for the purpose of introducing ROHM's products (hereinafter "Products"). If you wish to use any such Product, please be sure to refer to the specifications, which can be obtained from ROHM upon request.

Examples of application circuits, circuit constants and any other information contained herein illustrate the standard usage and operations of the Products. The peripheral conditions must be taken into account when designing circuits for mass production.

Great care was taken in ensuring the accuracy of the information specified in this document. However, should you incur any damage arising from any inaccuracy or misprint of such information, ROHM shall bear no responsibility for such damage.

The technical information specified herein is intended only to show the typical functions of and examples of application circuits for the Products. ROHM does not grant you, explicitly or implicitly, any license to use or exercise intellectual property or other rights held by ROHM and other parties. ROHM shall bear no responsibility whatsoever for any dispute arising from the use of such technical information.

The Products specified in this document are intended to be used with general-use electronic equipment or devices (such as audio visual equipment, office-automation equipment, communication devices, electronic appliances and amusement devices).

The Products specified in this document are not designed to be radiation tolerant.

While ROHM always makes efforts to enhance the quality and reliability of its Products, a Product may fail or malfunction for a variety of reasons.

Please be sure to implement in your equipment using the Products safety measures to guard against the possibility of physical injury, fire or any other damage caused in the event of the failure of any Product, such as derating, redundancy, fire control and fail-safe designs. ROHM shall bear no responsibility whatsoever for your use of any Product outside of the prescribed scope or not in accordance with the instruction manual.

The Products are not designed or manufactured to be used with any equipment, device or system which requires an extremely high level of reliability the failure or malfunction of which may result in a direct threat to human life or create a risk of human injury (such as a medical instrument, transportation equipment, aerospace machinery, nuclear-reactor controller, fuel-controller or other safety device). ROHM shall bear no responsibility in any way for use of any of the Products for the above special purposes. If a Product is intended to be used for any such special purpose, please contact a ROHM sales representative before purchasing.

If you intend to export or ship overseas any Product or technology specified herein that may be controlled under the Foreign Exchange and the Foreign Trade Law, you will be required to obtain a license or permit under the Law.



Thank you for your accessing to ROHM product informations.
More detail product informations and catalogs are available, please contact us.

ROHM Customer Support System

<http://www.rohm.com/contact/>

Компания «Океан Электроники» предлагает заключение долгосрочных отношений при поставках импортных электронных компонентов на взаимовыгодных условиях!

Наши преимущества:

- Поставка оригинальных импортных электронных компонентов напрямую с производств Америки, Европы и Азии, а так же с крупнейших складов мира;
- Широкая линейка поставок активных и пассивных импортных электронных компонентов (более 30 млн. наименований);
- Поставка сложных, дефицитных, либо снятых с производства позиций;
- Оперативные сроки поставки под заказ (от 5 рабочих дней);
- Экспресс доставка в любую точку России;
- Помощь Конструкторского Отдела и консультации квалифицированных инженеров;
- Техническая поддержка проекта, помощь в подборе аналогов, поставка прототипов;
- Поставка электронных компонентов под контролем ВП;
- Система менеджмента качества сертифицирована по Международному стандарту ISO 9001;
- При необходимости вся продукция военного и аэрокосмического назначения проходит испытания и сертификацию в лаборатории (по согласованию с заказчиком);
- Поставка специализированных компонентов военного и аэрокосмического уровня качества (Xilinx, Altera, Analog Devices, Intersil, Interpoint, Microsemi, Actel, Aeroflex, Peregrine, VPT, Syfer, Eurofarad, Texas Instruments, MS Kennedy, Miteq, Cobham, E2V, MA-COM, Hittite, Mini-Circuits, General Dynamics и др.);

Компания «Океан Электроники» является официальным дистрибьютором и эксклюзивным представителем в России одного из крупнейших производителей разъемов военного и аэрокосмического назначения «JONHON», а так же официальным дистрибьютором и эксклюзивным представителем в России производителя высокотехнологичных и надежных решений для передачи СВЧ сигналов «FORSTAR».



JONHON

«JONHON» (основан в 1970 г.)

Разъемы специального, военного и аэрокосмического назначения:

(Применяются в военной, авиационной, аэрокосмической, морской, железнодорожной, горно- и нефтедобывающей отраслях промышленности)

«FORSTAR» (основан в 1998 г.)

ВЧ соединители, коаксиальные кабели, кабельные сборки и микроволновые компоненты:

(Применяются в телекоммуникациях гражданского и специального назначения, в средствах связи, РЛС, а так же военной, авиационной и аэрокосмической отраслях промышленности).



Телефон: 8 (812) 309-75-97 (многоканальный)

Факс: 8 (812) 320-03-32

Электронная почта: ocean@oceanchips.ru

Web: <http://oceanchips.ru/>

Адрес: 198099, г. Санкт-Петербург, ул. Калинина, д. 2, корп. 4, лит. А