



MICRO SWITCH™  
Subminiature Basic Switches  
**ZX Series**



# MICRO SWITCH™ ZX Series

## Subminiature Basic Switches

Honeywell's MICRO SWITCH™ ZX Series is a subminiature snap-action switch from the family of Z series subminiature basic switches. Although small in size, the ZX Series is rated for controlling electrical loads ranging from logic-level/computer-based circuits to limited power-duty switching (up to 3 A/125 Vac). The ZX subminiature switch package is available with either solder terminals or a variety of different styles of printed circuit board (PCB) terminals to fulfill the requirements for electrical connectivity.

A wide variety of stainless steel levers are available and when combined with the subminiature package size, can adapt the ZX Series to a wide range of applications. To enhance the versatility of ZX switches, the family is certified to UL, cUL, ENEC, and CQC for worldwide use. The ZX Series is the right choice for a cost-effective subminiature switch package.

### *What makes our switches better?*

- Designed to operate in a variety of applications
- Current carrying capacity, up to 3 A, allows for a solution in many applications where space is a premium
- Cost-effective switch in a compact package
- Subminiature switch package designed to meet a wide range of temperature requirements



RIGHT SWITCH FOR THE RIGHT APPLICATION  
RELIABILITY • ELECTRICAL RATING

# Features and Benefits

## SMALL PACKAGE SIZE

**Subminiature package size** (6,5 mm x 12,8 mm [0.25 in x 0.50 in]) allows the MICRO SWITCH™ ZX Series switch to fit in applications where other sensors or switches are too large.

*Enhanced performance in a compact package*

## WELL SUITED FOR POWER-DUTY AND LOGIC-LEVEL LOADS

ZX switch design helps assure control of limited **power-duty switching** with silver contacts or **logic-level** (low voltage, and milliamperes) with gold-plated contacts.

## DESIGN FLEXIBILITY

Designed with a **pin plunger** for actuation, the ZX Series is also available with **various styles of levers**. The optional levers expand the versatility of the switch in the application. In addition, the ZX Series features a **variety of terminations** designed to provide flexibility for the electrical connectivity. Certified to **cUL, UL, ENEC, and CQC** for global applications, as well as RoHS compliant.

## WORLDWIDE AVAILABILITY

Entire family of ZX switches is available worldwide through Honeywell's network.

## Potential Applications



### INDUSTRIAL

- Circuit breaker box module interlock
- Electric utility meter tamper switch
- Tamper switch for computer modules

### COMMERCIAL

- Small residential appliances
- ATM equipment



### MEDICAL

- Hospital bed pendant controls
- Infusion pumps (end of travel)
- Syringes (end of travel)



# ZX Series

## PRODUCT NOMENCLATURE

<b>ZX</b>	<b>10</b>	<b>E</b>	<b>10</b>	<b>A</b>	<b>01</b>	<b>—</b>
Switch Type	Current Rating	Operating Force <sup>3</sup> (at pin plunger)	Terminal Type	Actuator Type <sup>4</sup> (Levers Mounted Internal)	Circuitry	Special Designator <sup>2</sup>
<b>ZX Series</b>	<b>10</b> 0.1 A 48 Vdc/125 Vac 0.2 A 60 Vdc gold-plated contacts	<b>C</b> 90 gf max.	<b>10</b> Solder, straight	<b>A</b> Pin plunger	<b>01</b> SPDT	A special designator is used to indicate non-standard features. This code consists of three alphanumeric characters max. A special designator is required when Terminal Type is "99" and/or Actuator Type is "S"
<b>Subminiature</b>			<b>20</b> PCB (straight)	<b>B</b> Short straight lever (10 mm)		
<b>Basic</b>	<b>40</b> 1 A/3 A 125 Vac silver contacts	<b>E</b> 150 gf max.	<b>30</b> PCB (snap-in)	<b>C</b> Standard straight lever (13 mm)		
<b>Switch</b>			<b>50</b> PCB (right side)	<b>E</b> Sim. roller lever (11,8 mm, r 2,5 mm)		
			<b>60</b> PCB (left side)	<b>F</b> Roller lever (10,7 mm, Ø 4,8 mm)		
			<b>99</b> SPECIAL <sup>2</sup>	<b>G</b> Sim. roller lever (10 mm, r 1,3 mm)		
				<b>H</b> Sim. roller lever (15 mm, r 1,3 mm)		
				<b>J</b> Long straight lever (30 mm)		
				<b>S</b> SPECIAL <sup>2</sup>		

**NOTES:**

<sup>1</sup> Not all combinations of model code are available.

Please contact your Honeywell provider/representative for assistance.

<sup>2</sup> Actuator Type "99" and/or Actuator Type "S" designates a special and requires a special designator at the end of the listing.

<sup>3</sup> Operating force is measured at the plunger. Adding an actuator/lever will change the operating force. See pages 6 and 7 for operating forces.

<sup>4</sup> Lever length dimension is measured as follows: Straight lever - from center line of lever pivot to end of lever;

Roller and simulated roller lever - from center line of pivot to center of roller diameter. See page 8 for dimension details.



# MICRO SWITCH™ Subminiature Basic Switches

**Table 1. Specifications**

Characteristic	ZX10 Series (Logic Level)	ZX40 Series (Power Duty)
Circuitry	SPDT	SPDT
Operating force	90 g or 150 g @ plunger	90 g or 150 g @ plunger
Termination	PCB, solder	PCB, solder
Sealing	internal live parts protected to IP40, IP00 due to exposed terminals	internal live parts protected to IP40, IP00 due to exposed terminals
Actuators (levers 300 series stainless steel)	pin plunger, short flat lever, standard flat lever, long flat lever, roller lever, short simulated roller lever, standard simulated roller lever, long sim. roller lever, special levers	pin plunger, short flat lever, standard flat lever, long flat lever, roller lever, short simulated roller lever, standard simulated roller lever, long sim. roller lever, special levers
Agency certification	UL, cUL, ENEC, CQC, RoHS compliant	UL, cUL, ENEC, CQC, RoHS complaint
Operating temperature (manufacturer rated)	-40 °C to 85 °C [-40 °F to 185 °F]	-40 °C to 85 °C [-40 °F to 185 °F]
Mechanical endurance (cycles)	3,000,000 min. @ 120 cycles/minute max.	3,000,000 min. @ 120 cycles/minute max.
Electrical endurance (cycles)	10,000 min. @ 30 cycles/minute max.	10,000 min. @ 30 cycles/minute max.
Switch resistance (initial)	100 mΩ max.	50 mΩ max.
Insulation resistance (initial)	100 MΩ min. (500 Vdc for one minute)	100 MΩ min. (500 Vdc for one minute)
Dielectric strength (initial) (between live parts and ground)	1500 VRMS for one minute ≤0.5 mA leakage current	1500 VRMS for one minute ≤0.5 mA leakage current
Contact material	gold-plated silver	silver
Housing material	case, polyamide (nylon); cover, polyamide (nylon)	case, polyamide (nylon); cover, polyamide (nylon)

Note: Refer to engineering drawing for additional information.

**Table 2. Electrical Ratings**

Switch Option	CQC (Asia-Pacific) Per GB 15092-1	ENEC (Europe) Per IEC 61058-1	UL, cUL (Americas) UL 61058-1, File 12252
ZX10 Series (Gold-plated contacts)	0.1 A, 125 Vac 0.1 A 48 Vdc, 0.2 A 60 Vdc 10,000 cycles	0.1 A, 125 Vac 0.1 A 48 Vdc, 0.2 A 60 Vdc 10,000 cycles	0.1 RA, 125 Vac 0.1 RA 48 Vdc, 0.2 RA 60 Vdc 10,000 cycles
ZX40 Series (Silver contacts)	3 A, 125 Vac 10,000 cycles	3 A, 125 Vac 10,000 cycles	3 RA, 125 Vac 10,000 cycles

Note: UL, cUL; CQC and ENEC “use temperature”; 0 °C to 55 °C [32 °F to 131 °F].

# ZX Series

- O.F. • Operating force
- R.F. • Release force
- P.T. • Pretravel
- O.T. • Overtravel
- D.T. • Differential travel
- O.P. • Operating position

## PRODUCT SPECIFICATIONS AND LISTINGS

Contact your Honeywell rep or distributor for additional listings

	Catalog Listing	Contact Material	Elect. Rating Spec. (page 4)	Termination	O.F. max. N [g]	R.F. min. N [g]	O.P. from mounting hole mm [in] (see page 8)	O.P. from plastic switch base mm [in] (see page 8)	O.P. from form in PCB terminals mm [in] (see page 8)	P.T. max. mm [in]	O.T. min. mm [in]	D.T. max. mm [in]
 <p>Pin plunger</p>	<b>ZX10C10A01</b>	Gold Plated	0.1 A	Solder	0,88 [90]	0,15 [15]	5,5 ±0,3 [0.22 ±0.01]	-	-	1,3 [0.05]	0,2 [0.01]	0,3 [0.01]
	<b>ZX10C30A01</b>	Gold Plated	0.1 A	PCB Snap-in	0,88 [90]	0,15 [15]	-	7,0 ±0,3 [0.28 ±0.01]	-	1,3 [0.05]	0,2 [0.01]	0,3 [0.01]
	<b>ZX10C50A01</b>	Gold Plated	0.1 A	PCB Right	0,88 [90]	0,15 [15]	-	-	9,1 ±0,3 [0.36 ±0.01]	1,3 [0.05]	0,2 [0.01]	0,3 [0.01]
	<b>ZX10C60A01</b>	Gold Plated	0.1 A	PCB Left	0,88 [90]	0,15 [15]	-	-	9,1 ±0,3 [0.36 ±0.01]	1,3 [0.05]	0,2 [0.01]	0,3 [0.01]
	<b>ZX10E10A01</b>	Gold Plated	0.1 A	Solder	1,47 [150]	0,2 [20]	5,5 ±0,3 [0.22 ±0.01]	-	-	1,3 [0.05]	0,2 [0.01]	0,3 [0.01]
	<b>ZX40C20A01</b>	Silver	3 A	PCB Straight	0,88 [90]	0,15 [15]	-	7,0 ±0,3 [0.28 ±0.01]	-	1,3 [0.05]	0,2 [0.01]	0,3 [0.01]
	<b>ZX40C30A01</b>	Silver	3 A	PCB Snap-in	0,88 [90]	0,15 [15]	-	7,0 ±0,3 [0.28 ±0.01]	-	1,3 [0.05]	0,2 [0.01]	0,3 [0.01]
	<b>ZX40E10A01</b>	Silver	3 A	Solder	1,47 [150]	0,2 [20]	5,5 ±0,3 [0.22 ±0.01]	-	-	1,3 [0.05]	0,2 [0.01]	0,3 [0.01]
	<b>ZX40E30A01</b>	Silver	3 A	PCB Snap-in	1,47 [150]	0,2 [20]	-	7,0 ±0,3 [0.28 ±0.01]	-	1,3 [0.05]	0,2 [0.01]	0,3 [0.01]
	<b>ZX40E60A01</b>	Silver	3 A	PCB Left	1,47 [150]	0,2 [20]	-	-	9,1 ±0,3 [0.36 ±0.01]	1,3 [0.05]	0,2 [0.01]	0,3 [0.01]
 <p>Std. straight Lever 13 mm [0.51 in]</p>	<b>ZX10C10C01</b>	Gold Plated	0.1 A	Solder	0,29 [30]	0,05 [5]	6,9 ±0,8 [0.27 ±0.03]	-	-	3,4 [0.13]	0,6 [0.02]	1,3 [0.05]
	<b>ZX10C30C01</b>	Gold Plated	0.1 A	PCB Snap-in	0,29 [30]	0,05 [5]	-	8,4 ±0,8 [0.33 ±0.03]	-	3,4 [0.13]	0,6 [0.02]	1,3 [0.05]
	<b>ZX10C50C01</b>	Gold Plated	0.1 A	PCB Right	0,29 [30]	0,05 [5]	-	-	10,5 ±0,8 [0.41 ±0.03]	3,4 [0.13]	0,6 [0.02]	1,3 [0.05]
	<b>ZX10E10C01</b>	Gold Plated	0.1 A	Solder	0,49 [50]	0,08 [8]	6,9 ±0,8 [0.27 ±0.03]	-	-	3,4 [0.13]	0,6 [0.02]	1,3 [0.05]
	<b>ZX10E30C01</b>	Gold Plated	0.1 A	PCB Snap-in	0,49 [50]	0,08 [8]	-	8,4 ±0,8 [0.33 ±0.03]	-	3,4 [0.13]	0,6 [0.02]	1,3 [0.05]
	<b>ZX10E50C01</b>	Gold Plated	0.1 A	PCB Right	0,49 [50]	0,08 [8]	-	-	10,5 ±0,8 [0.41 ±0.03]	3,4 [0.13]	0,6 [0.02]	1,3 [0.05]
	<b>ZX10E60C01</b>	Gold Plated	0.1 A	PCB Left	0,49 [50]	0,08 [8]	-	-	10,5 ±0,8 [0.41 ±0.03]	3,4 [0.13]	0,6 [0.02]	1,3 [0.05]
	<b>ZX40C10C01</b>	Silver	3 A	Solder	0,29 [30]	0,05 [5]	6,9 ±0,8 [0.27 ±0.03]	-	-	3,4 [0.13]	0,6 [0.02]	1,3 [0.05]
	<b>ZX40C30C01</b>	Silver	3 A	PCB Snap-in	0,29 [30]	0,05 [5]	-	8,4 ±0,8 [0.33 ±0.03]	-	3,4 [0.13]	0,6 [0.02]	1,3 [0.05]
	<b>ZX40E10C01</b>	Silver	3 A	Solder	0,49 [50]	0,08 [8]	6,9 ±0,8 [0.27 ±0.03]	-	-	3,4 [0.13]	0,6 [0.02]	1,3 [0.05]
	<b>ZX40E20C01</b>	Silver	3 A	PCB Straight	0,49 [50]	0,08 [8]	-	8,4 ±0,8 [0.33 ±0.03]	-	3,4 [0.13]	0,6 [0.02]	1,3 [0.05]
	<b>ZX40E30C01</b>	Silver	3 A	PCB Snap-in	0,49 [50]	0,08 [8]	-	8,4 ±0,8 [0.33 ±0.03]	-	3,4 [0.13]	0,6 [0.02]	1,3 [0.05]
	<b>ZX40E60C01</b>	Silver	3 A	PCB Left	0,49 [50]	0,08 [8]	-	-	10,5 ±0,8 [0.41 ±0.03]	3,4 [0.13]	0,6 [0.02]	1,3 [0.05]

# MICRO SWITCH™ Subminiature Basic Switches

- O.F. • Operating force
- R.F. • Release force
- P.T. • Pretravel
- O.T. • Overtravel
- D.T. • Differential travel
- O.P. • Operating position

	Catalog Listing	Contact Material	Elect. Rating Spec. (page 4)	Termination	O.F. max. N [g]	R.F. min. N [g]	O.P. from mounting hole mm [in] (see page 8)	O.P. from plastic switch base mm [in] (see page 8)	O.P. from form in PCB terminals mm [in] (see page 8)	P.T. max. mm [in]	O.T. min. mm [in]	D.T. max. mm [in]
 Short straight lever 10 mm [0.40 in]	<b>ZX10C30B01</b>	Gold Plated	0.1 A	PCB Snap-in	0,39 [40]	0,06 [6]	-	7,9 ±0,8 [0.31 ±0.03]	-	3,4 [0.13]	0,6 [0.02]	1,0 [0.04]
 Std. sim. roller lever, 11,8 mm [0.47 in]	<b>ZX10C30E01</b>	Gold Plated	0.1 A	PCB Snap-in	0,34 [35]	0,05 [5]	-	11,1 ±0,8 [0.44 ±0.03]	-	3,8 [0.15]	0,6 [0.02]	1,3 [0.05]
	<b>ZX10E10E01</b>	Gold Plated	0.1 A	Solder	0,54 [55]	0,08 [8]	9,6 ±0,8 [0.38 ±0.03]	-	-	3,8 [0.15]	0,6 [0.02]	1,3 [0.05]
	<b>ZX10E20E01</b>	Gold Plated	0.1 A	PCB Straight	0,54 [55]	0,08 [8]	-	11,1 ±0,8 [0.44 ±0.03]	-	3,8 [0.15]	0,6 [0.02]	1,3 [0.05]
	<b>ZX10E50E01</b>	Gold Plated	0.1 A	PCB Right	0,54 [55]	0,08 [8]	-	-	13,2 ±0,8 [0.52 ±0.03]	3,8 [0.15]	0,6 [0.02]	1,3 [0.05]
	<b>ZX40E10E01</b>	Silver	3 A	Solder	0,54 [55]	0,08 [8]	9,6 ±0,8 [0.38 ±0.03]	-	-	3,8 [0.15]	0,6 [0.02]	1,3 [0.05]
	<b>ZX40E30E01</b>	Silver	3 A	PCB Snap-in	0,54 [55]	0,08 [8]	-	11,1 ±0,8 [0.44 ±0.03]	-	3,8 [0.15]	0,6 [0.02]	1,3 [0.05]
	<b>ZX40E50E01</b>	Silver	3 A	PCB Right	0,54 [55]	0,08 [8]	-	-	13,2 ±0,8 [0.52 ±0.03]	3,8 [0.15]	0,6 [0.02]	1,3 [0.05]
 Short sim. roller lever, 10 mm [0.40 in]	<b>ZX10E20G01</b>	Gold Plated	0.1 A	PCB Straight	0,69 [70]	0,06 [6]	-	10,23 ±0,8 [0.40 ±0.03]	-	2,6 [0.10]	0,4 [0.02]	1,0 [0.04]
 Long sim. roller lever 15 mm [0.59 in]	<b>ZX40C30H01</b>	Silver	3 A	PCB Snap-in	0,26 [27]	0,04 [4]	-	10,5 ±0,8 [0.41 ±0.03]	-	3,8 [0.15]	0,6 [0.02]	1,5 [0.06]
 Long straight lever, 30 mm [1.18 in]	<b>ZX10C20J01</b>	Gold Plated	0.1 A	PCB Straight	0,15 [15]	0,02 [2]	-	10,79 ±2,1 [0.42 ±0.08]	-	10,1 [0.4]	0,9 [0.04]	3,0 [0.12]
	<b>ZX10C30J01</b>	Gold Plated	0.1 A	PCB Snap-in	0,15 [15]	0,02 [2]	-	10,79 ±2,1 [0.42 ±0.08]	-	10,1 [0.4]	0,9 [0.04]	3,0 [0.12]
	<b>ZX40E10J01</b>	Silver	3 A	Solder	0,22 [22]	0,03 [3]	9,29 ±2,1 [0.37 ±0.08]	-	-	10,1 [0.40]	0,9 [0.04]	3,0 [0.12]

# ZX Series

## MOUNTING DIMENSIONS

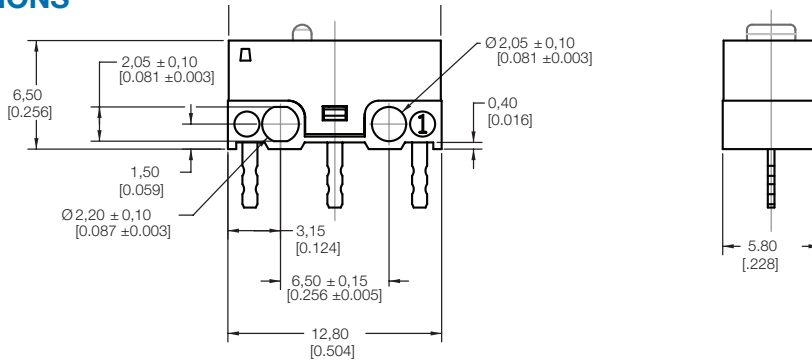

**TYPE 10 - SOLDER STRAIGHT**



**TYPE 20 - PCB STRAIGHT**



**TYPE 30 - PCB SNAP-IN**



**TYPE 50 - PCB RIGHT SIDE**

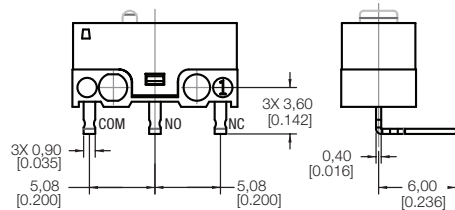

**TYPE 60 - PCB LEFT SIDE**

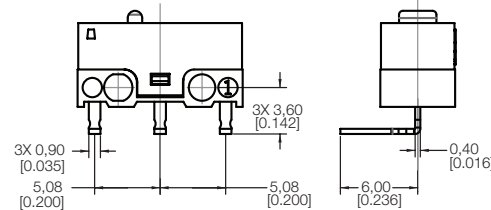

**TYPE A  
PIN PLUNGER**

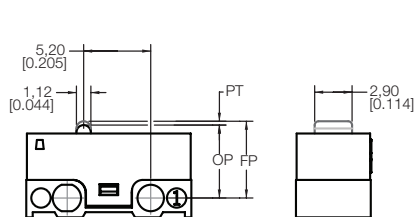

**TYPE B  
SHORT STRAIGHT LEVER (10,0 mm)**

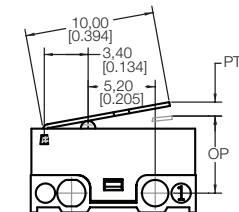

**TYPE C  
STANDARD STRAIGHT LEVER (13,0 mm)**

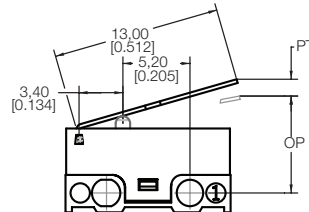

**TYPE E  
SIMULATED ROLLER LEVER (11,8 mm; R2.5)**

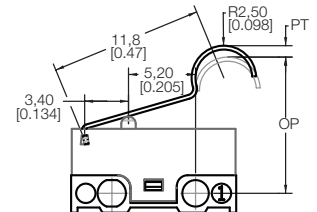

**TYPE F  
ROLLER LEVER (10,7 mm, ROLLER Ø4,8)**

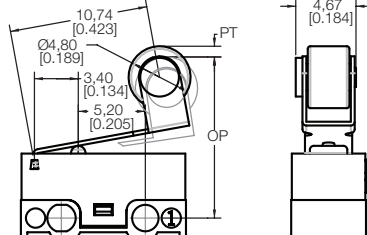

**TYPE G  
SIMULATED ROLLER LEVER (10,0 mm, R1.3)**

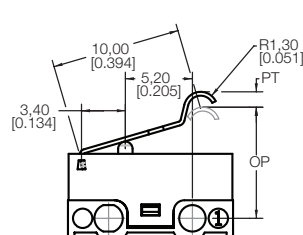

**TYPE H  
SIMULATED ROLLER LEVER (15,0 mm; R1.3)**

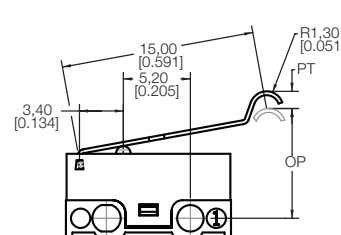

**TYPE J  
LONG STRAIGHT LEVER (30,0 mm)**

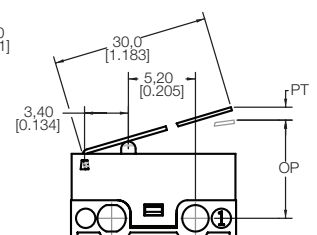

ABOVE OP FROM MOUNTING HOLE

**Notes:**

1. Unless otherwise specified, tolerance of  $\pm 0,4$  mm [0.016 in] applies to all dimensions.
2. All terminal thickness tolerances  $\pm 0,05$  mm [0.002 in].

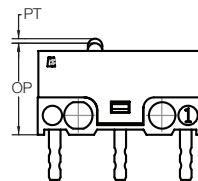

OP FROM BASE  
(FOR TYPE 20 & 30 TERMINAL)

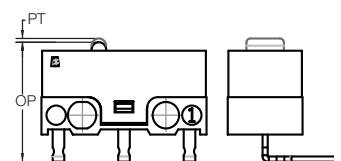

OP FROM TERMINAL  
(FOR TYPE 50 & 60 TERMINAL)



## ADDITIONAL INFORMATION

The following associated literature is available on the Honeywell web site at [sensing.honeywell.com](http://sensing.honeywell.com):

- Product installation instructions
- Product range guide
- Product nomenclature tree
- Product application-specific information
  - Application note: Sensors and switches in chemistry analyzers
  - Application note: Sensors and switches for potential HVAC/R applications
  - Application note: Sensors and switches for potential medical applications
  - Technical bulletin: Applying precision switches
  - Technical bulletin: Low energy switch guide

### Find out more

Honeywell serves its customers through a worldwide network of sales offices, representatives and distributors. For application assistance, current specifications, pricing or name of the nearest Authorized Distributor, contact your local sales office.

To learn more about Honeywell's sensing and switching products, call **+1-815-235-6847** or **1-800-537-6945**, visit **[sensing.honeywell.com](http://sensing.honeywell.com)**, or e-mail inquiries to **[info.sc@honeywell.com](mailto:info.sc@honeywell.com)**

Sensing and Productivity Solutions  
Honeywell  
1985 Douglas Drive North  
Golden Valley, MN 55422  
**[honeywell.com](http://honeywell.com)**

### **WARNING** **PERSONAL INJURY**

**DO NOT USE** these products as safety or emergency stop devices or in any other application where failure of the product could result in personal injury.

**Failure to comply with these instructions could result in death or serious injury.**

### **WARNING** **MISUSE OF DOCUMENTATION**

- The information presented in this product sheet is for reference only. Do not use this document as a product installation guide.
- Complete installation, operation, and maintenance information is provided in the instructions supplied with each product.

**Failure to comply with these instructions could result in death or serious injury.**

## WARRANTY/REMEDY

Honeywell warrants goods of its manufacture as being free of defective materials and faulty workmanship. Honeywell's standard product warranty applies unless agreed to otherwise by Honeywell in writing; please refer to your order acknowledgement or consult your local sales office for specific warranty details. If warranted goods are returned to Honeywell during the period of coverage, Honeywell will repair or replace, at its option, without charge those items it finds defective. **The foregoing is buyer's sole remedy and is in lieu of all other warranties, expressed or implied, including those of merchantability and fitness for a particular purpose. In no event shall Honeywell be liable for consequential, special, or indirect damages.**

While we provide application assistance personally, through our literature and the Honeywell website, it is up to the customer to determine the suitability of the product in the application.

Specifications may change without notice. The information we supply is believed to be accurate and reliable as of this printing. However, we assume no responsibility for its use.

# Honeywell

Компания «Океан Электроники» предлагает заключение долгосрочных отношений при поставках импортных электронных компонентов на взаимовыгодных условиях!

Наши преимущества:

- Поставка оригинальных импортных электронных компонентов напрямую с производств Америки, Европы и Азии, а так же с крупнейших складов мира;
- Широкая линейка поставок активных и пассивных импортных электронных компонентов (более 30 млн. наименований);
- Поставка сложных, дефицитных, либо снятых с производства позиций;
- Оперативные сроки поставки под заказ (от 5 рабочих дней);
- Экспресс доставка в любую точку России;
- Помощь Конструкторского Отдела и консультации квалифицированных инженеров;
- Техническая поддержка проекта, помощь в подборе аналогов, поставка прототипов;
- Поставка электронных компонентов под контролем ВП;
- Система менеджмента качества сертифицирована по Международному стандарту ISO 9001;
- При необходимости вся продукция военного и аэрокосмического назначения проходит испытания и сертификацию в лаборатории (по согласованию с заказчиком);
- Поставка специализированных компонентов военного и аэрокосмического уровня качества (Xilinx, Altera, Analog Devices, Intersil, Interpoint, Microsemi, Actel, Aeroflex, Peregrine, VPT, Syfer, Eurofarad, Texas Instruments, MS Kennedy, Miteq, Cobham, E2V, MA-COM, Hittite, Mini-Circuits, General Dynamics и др.);

Компания «Океан Электроники» является официальным дистрибьютором и эксклюзивным представителем в России одного из крупнейших производителей разъемов военного и аэрокосмического назначения «JONHON», а так же официальным дистрибьютором и эксклюзивным представителем в России производителя высокотехнологичных и надежных решений для передачи СВЧ сигналов «FORSTAR».



## JONHON

«JONHON» (основан в 1970 г.)

Разъемы специального, военного и аэрокосмического назначения:

(Применяются в военной, авиационной, аэрокосмической, морской, железнодорожной, горно- и нефтедобывающей отраслях промышленности)

«FORSTAR» (основан в 1998 г.)

ВЧ соединители, коаксиальные кабели, кабельные сборки и микроволновые компоненты:

(Применяются в телекоммуникациях гражданского и специального назначения, в средствах связи, РЛС, а так же военной, авиационной и аэрокосмической отраслях промышленности).



Телефон: 8 (812) 309-75-97 (многоканальный)

Факс: 8 (812) 320-03-32

Электронная почта: [ocean@oceanchips.ru](mailto:ocean@oceanchips.ru)

Web: <http://oceanchips.ru/>

Адрес: 198099, г. Санкт-Петербург, ул. Калинина, д. 2, корп. 4, лит. А