



The Future of Analog IC Technology®

MP2016

42V, 30mA, Low Power Adjustable Output Linear Regulator

DESCRIPTION

The MP2016 is a low power linear regulator that supplies power to systems with high voltage batteries. It includes a wide 4V to 42V input range, low dropout voltage and low quiescent supply current.

The MP2016 provides excellent line transient response time and 50dB power supply rejection ratio (PSRR). The MP2016 can be set externally from 1.2V to 40V through a simple resistor divider network.

The MP2016 also includes thermal shutdown and current limiting fault protection. It is available in TSOT23-5 and QFN-8 packages.

FEATURES

- 4V to 42V Input Range
- 12 μ A Quiescent Supply Current
- <1.5 μ A Shutdown Current
- 1.2V to 40V Adjustable Output
- 30mA Output Current with 50mA Peak Current Limit
- \pm 2% Accuracy
- Thermal Shutdown
- Available in Tiny TSOT23-5 and QFN-8 Packages

APPLICATIONS

- Notebook Computers
- Smart-Battery Packs
- PDAs
- Handheld Devices
- Battery-Powered Systems

For MPS green status, please visit MPS website under Quality Assurance. "MPS" and "The Future of Analog IC Technology" are Registered Trademarks of Monolithic Power Systems, Inc.

TYPICAL APPLICATION

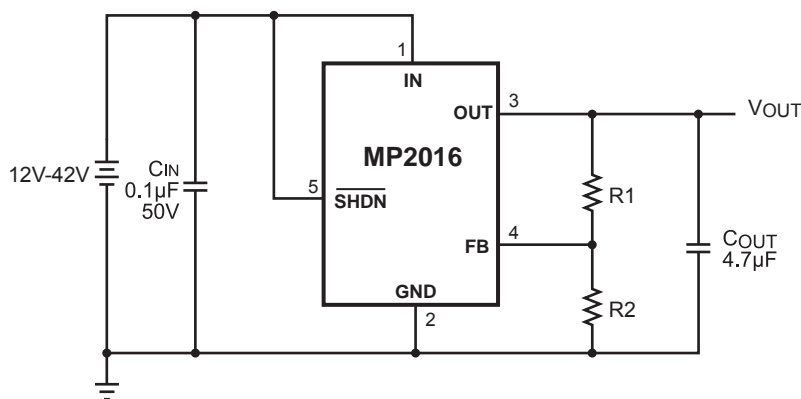

ORDERING INFORMATION

Part Number	Package	Top Marking	Free Air Temperature (T _A)
MP2016DJ*	TSOT23-5	R2	-40°C to +85°C
MP2016DD**	QFN-8 (2 x 3mm)	$\overline{R2}$	-40°C to +85°C

* For Tape & Reel, add suffix -Z (g. MP2016DJ-Z).

For RoHS compliant packaging, add suffix -LF (e.g. MP2016DJ-LF-Z)

** For Tape & Reel, add suffix -Z (g. MP2016DD-Z).

For RoHS compliant packaging, add suffix -LF (e.g. MP2016DD-LF-Z)

PACKAGE REFERENCE

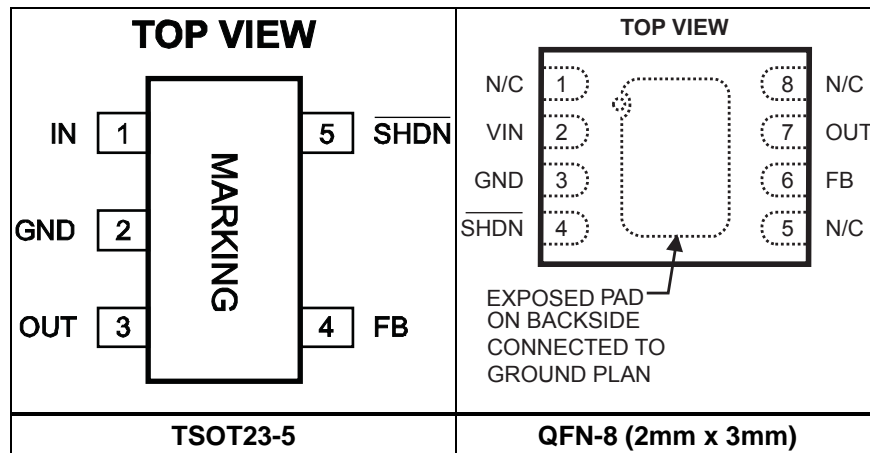

ABSOLUTE MAXIMUM RATINGS ⁽¹⁾

IN, $\overline{\text{SHDN}}$	-0.3V to +45V
GND	-0.3V to V _{IN} + 0.3V
FB	-0.3V to + 1.5V

Continuous Power Dissipation (T_A = +25°C) ⁽²⁾

TSOT23-5.....	0.6.W
QFN8 (2X3mm).....	2.3W
Lead Temperature	260°C
Storage Temperature.....	-65°C to +150°C

Recommended Operating Conditions ⁽³⁾

Supply Voltage V _{IN}	4V to 42V
Output Voltage V _{OUT}	1.2V to 40V
Maximum Junction Temp. (T _J).....	+125°C

Thermal Resistance ⁽⁴⁾

	θ_{JA}	θ_{JC}
TSOT23-5	220	110 .. °C/W
QFN8 (2 x 3mm)	55	12 ... °C/W

Notes:

- Exceeding these ratings may damage the device.
- The maximum allowable power dissipation is a function of the maximum junction temperature T_J (MAX), the junction-to-ambient thermal resistance θ_{JA} , and the ambient temperature T_A. The maximum allowable continuous power dissipation at any ambient temperature is calculated by P_D (MAX) = (T_J (MAX)-T_A)/ θ_{JA} . Exceeding the maximum allowable power dissipation will cause excessive die temperature, and the regulator will go into thermal shutdown. Internal thermal shutdown circuitry protects the device from permanent damage.
- The device is not guaranteed to function outside of its operating conditions.
- Measured on JESD51-7, 4-layer PCB.

ELECTRICAL CHARACTERISTICS

$V_{IN} = 15V$, $I_{LOAD} = 5\mu A$, $T_A = +25^\circ C$, unless otherwise noted.

Parameter	Symbol	Condition	Min	Typ	Max	Units
Input Voltage	V_{IN}		4		42	V
Input Supply Current	I_{IN}	$T_A = +25^\circ C$		12		μA
		$T_A = -40^\circ C$ to $+85^\circ C$			30	
Minimum Load Current					0	μA
Shutdown Supply Current	I_S	Shutdown Mode, $T_A = +25^\circ C$			8	μA
		Shutdown Mode, $T_A = -40^\circ C$ to $+85^\circ C$			10	
FB Threshold	V_{FB}	FB = OUT, $I_{LOAD} = 1mA$	1.205	1.23	1.254	V
		FB = OUT, $I_{LOAD} = 5\mu A$ to $30mA$, $T_A = -40^\circ C$ to $+85^\circ C$	1.181	1.23	1.279	
FB Input Current	I_{FB}	$V_{FB} = 1.3V$	-30	+4	+30	nA
Dropout Voltage ⁽⁶⁾	$V_{DROPOUT}$	$I_{LOAD} = 30mA$		700	900	mV
PSRR		DC, $I_{OUT} = 10mA$		65		dB
Current Limit		$V_{IN} = 6V$		50		mA
Ground current		$I_{OUT} = 35mA$		35		μA
Capacitive Requirements	Load		0.23			$\mu F/mA$
Startup Response Time		$R_L = 500\Omega$, $C_2 = 6.8\mu F$, $V_{OUT} = 5V$			1	ms
Startup Overshoot	V_{OSH}	$R_L = 500\Omega$, $C_2 = 10\mu F$ within 90% of the nominal output voltage		0.58		% V_{OUT}
SHDN Input Threshold Voltage	V_{IL}				0.22	V
	V_{IH}		1.8			
SHDN Input Current		$\overline{SHDN} = 0V$ or $15V$		0.6	1.5	μA
Line Regulation				0.023		%/V
Load Regulation				0.003		%/mA
Thermal Shutdown		$\overline{SHDN} = 0V$ or $15V$, Hysteresis = $+20^\circ C$		150		$^\circ C$

Note:

- 5) 100% production tested at $T_A = 25^\circ C$. Specifications over the temperature range are guaranteed by design and characterization.
 6) Dropout Voltage is defined as the in put to output differential when the output voltage drops 1% below its nominal value.

PIN FUNCTIONS

QFN Pin #	TSOT23 Pin #	Name	Description
2	1	VIN	Input Voltage. Connect a 4V to 42V supply to this pin.
3	2	GND, Exposed Pad	Ground (the exposed pad and GND pin must be connected to the same ground plane for QFN package).
7	3	OUT	Regulator Output.
6	4	FB	Feedback. This is the feedback input pin, regulated to 1.23V nominally.
4	5	$\overline{\text{SHDN}}$	Shutdown. A logic LOW on this pin will shut down the IC; a logic HIGH will start it up. Connect this pin to IN for automatic startup.
1, 5, 8		N/C	No Connect.

TYPICAL PERFORMANCE CHARACTERISTICS

$C_{IN} = 1\mu F$, $C_{OUT} = 4.7\mu F$, $T_A = +25^\circ C$, unless otherwise noted.

Output Voltage vs. Load Current

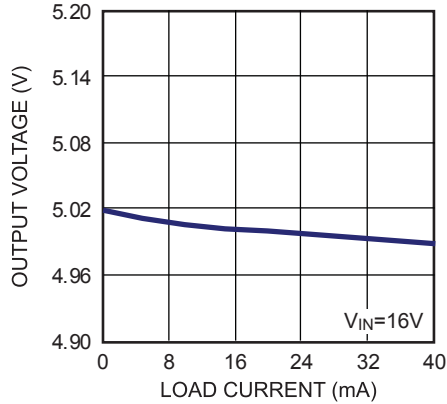

Output Voltage vs. Load Current

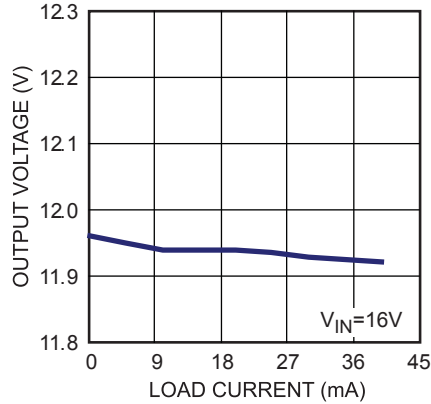

Output Voltage vs. Input Voltage

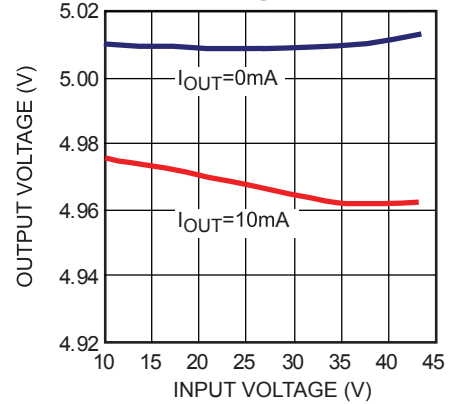

Output Voltage vs. Input Voltage

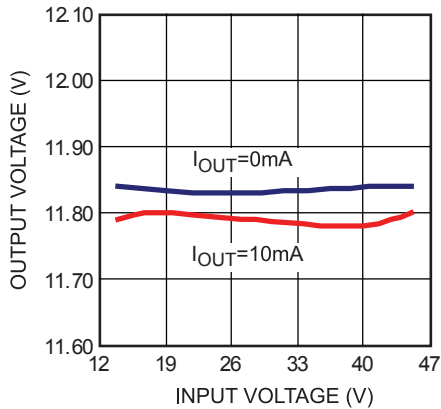

Dropout Voltage

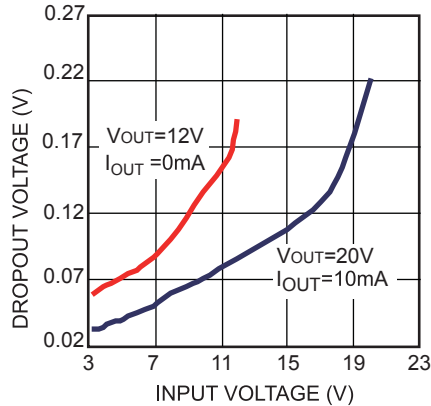

PSRR vs. Frequency

$V_{IN} = V_{SHDN} = 4V$,

$V_{OUT} = 1.8V$, $I_{OUT} = 10mA$,

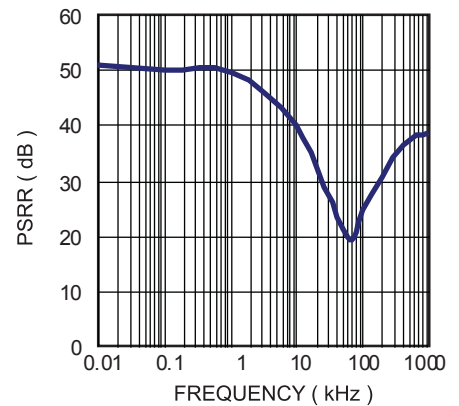

VOUT vs. Temperature

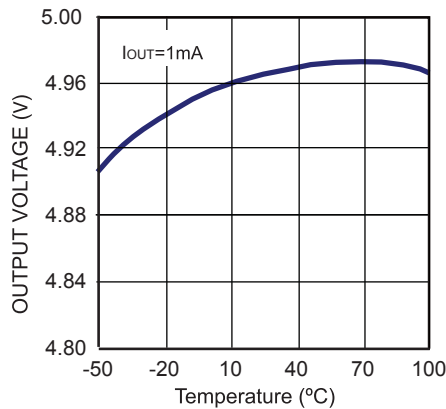

VFB vs. Temperature

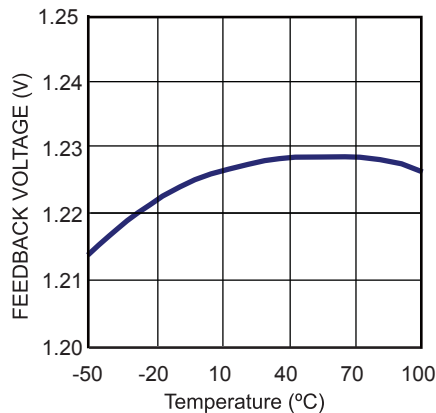

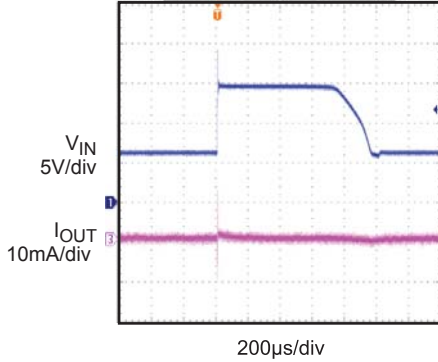
TYPICAL PERFORMANCE CHARACTERISTICS (continued)
 $C_{IN} = 1\mu F$, $C_{OUT} = 4.7\mu F$, $T_A = +25^\circ C$, unless otherwise noted.
Line Transient
 $V_{IN} = V_{SHDN} = 7V$ to $12V$, $V_{OUT} = 5V$,
 $I_{OUT} = 20mA$

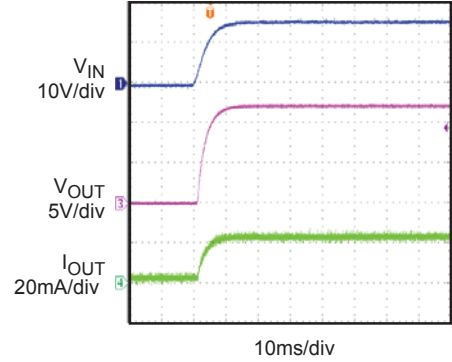
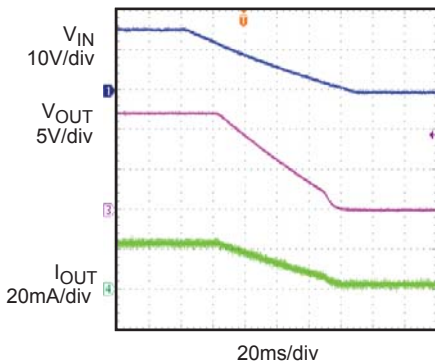
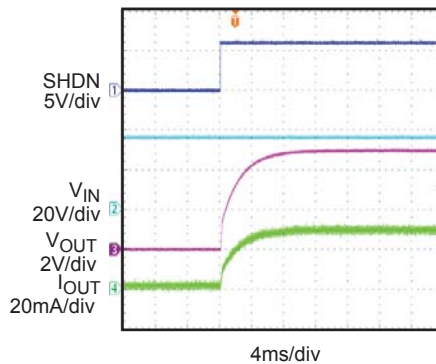
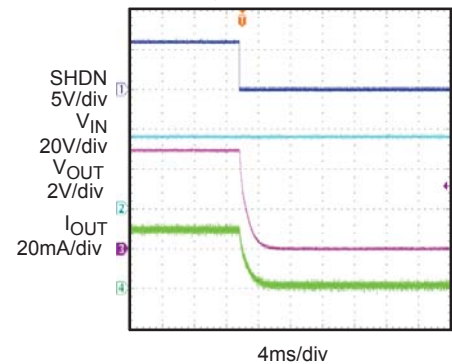
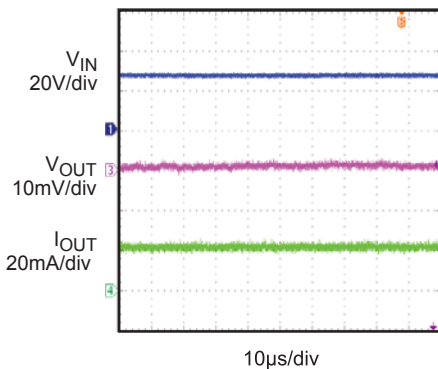
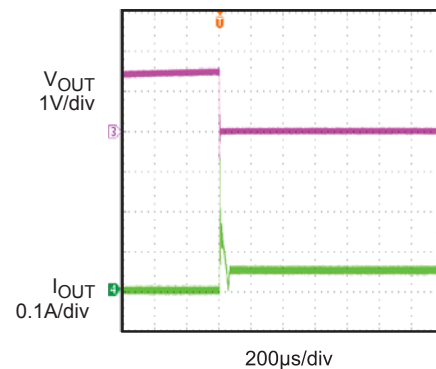
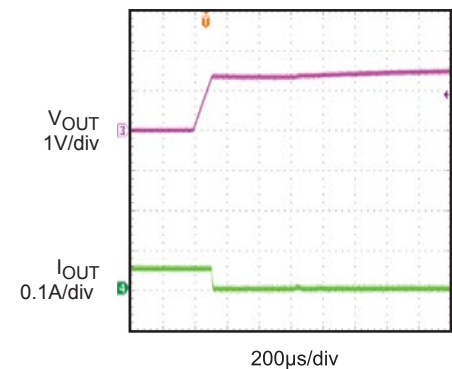
Load Transient
 $V_{IN} = V_{SHDN} = 15V$, $V_{OUT} = 12V$,
 $I_{OUT} = 10mA$ to $30mA$

VIN Ramp Up
 $V_{IN} = V_{SHDN} = 16V$,
 $V_{OUT} = 12V$, $I_{IN} = 20mA$

VIN Ramp Down
 $V_{IN} = V_{SHDN} = 16V$,
 $V_{OUT} = 12V$, $I_{IN} = 20mA$

Enable Response
 $V_{IN} = 35V$, $V_{SHDN} = 6V$,
 $V_{OUT} = 5V$, $I_{OUT} = 30mA$

Shutdown Response
 $V_{IN} = 35V$, $V_{SHDN} = 6V$,
 $V_{OUT} = 5V$, $I_{OUT} = 30mA$

Load Ripple
 $V_{IN} = V_{SHDN} = 28V$, $V_{OUT} = 24V$
 $I_{OUT} = 20mA$

Short Circuit
 $V_{IN} = V_{SHDN} = 5V$,
 $V_{OUT} = 1.8V$

Short Circuit Recovery
 $V_{IN} = V_{SHDN} = 5V$,
 $V_{OUT} = 1.8V$

OPERATION

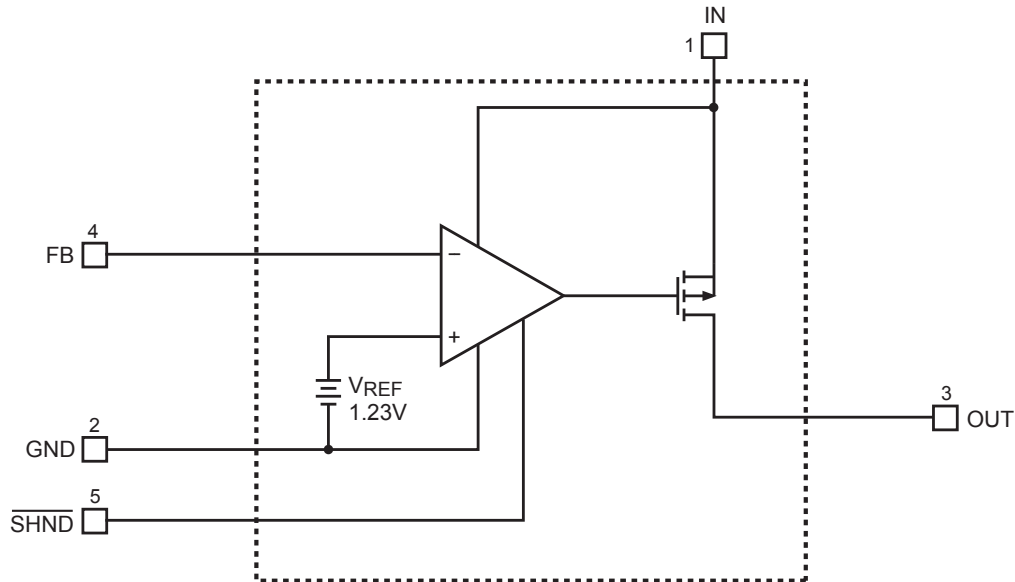

Figure 1—Functional Block Diagram

The MP2016 is a linear regulator designed primarily for high input voltage applications. The MP2016 has an output that is adjustable from 1.2V to 40V with a simple resistor divider. The maximum power output current is a function of the package's maximum power dissipation for a given temperature.

The MP2016 uses external feedback, allowing the user to set the output voltage with an external resistor divider. The typical FB pin threshold is 1.23V.

The IC enters shutdown mode when $\overline{\text{SHDN}}$ is low. In shutdown mode, the pass transistor, control circuitry, reference and all biases turn off, reducing the supply current to $<2\mu\text{A}$. Connect $\overline{\text{SHDN}}$ to IN for automatic startup.

The peak output current is limited to 50mA, which exceeds the 30mA recommended continuous output current. The output can be shorted to ground for 30 seconds without damaging the part.

When the junction temperature is too high, the thermal sensor sends a signal to the control logic that will shutdown the IC. The IC will restart when the temperature has sufficiently cooled.

The maximum power dissipation is dependent on the thermal resistance of the case and the circuit board, the temperature difference between the die junction and the ambient air, and the rate of air flow. The GND pin and Exposed Pad must be connected to the ground plane for proper dissipation.

APPLICATION INFORMATION

COMPONENT SELECTION

Setting the Output Voltage

Set the output voltage of the MP2016 by using a resistor divider as shown:

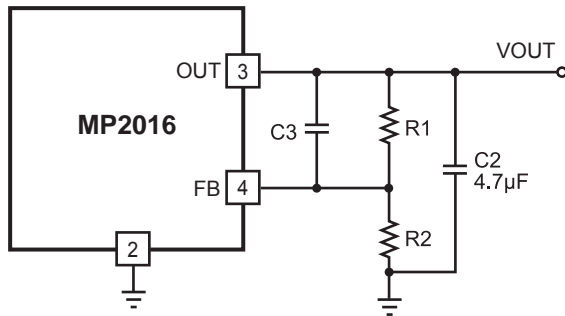

Figure 2—MP2016 with External Resistor Divider

Choose $R2=250k\Omega$ to maintain a $5\mu A$ minimum load. Calculate the value for $R1$ using the following equation:

$$R1 = R2 \times \left(\frac{V_{OUT}}{1.23V} - 1 \right)$$

Input Capacitor

For proper operation, place a ceramic capacitor ($C1$) between $1\mu F$ and $10\mu F$ of dielectric type X5R or X7R between the input pin and ground. Larger values in this range will help improve line transient response.

Output Capacitor

For stable operation, use a ceramic capacitor ($C2$) of type X5R or X7R between $1\mu F$ and $10\mu F$. Larger values in this range will help improve load transient response and reduce noise. Output capacitors of other dielectric types may be used, but are not recommended as their capacitance can deviate greatly from their rated value over temperature.

To improve load transient response, add a small ceramic (X5R, X7R or Y5V dielectric) $22nF$ feed forward capacitor in parallel with $R1$. The feed forward capacitor is not required for stable operation.

Output Noise

The MP2016 will exhibit noise on the output during normal operation. This noise is negligible for most applications. However, in applications that include analog-to-digital converters (ADCs) of more than 12 bits, one needs to consider the ADC's power supply rejection specifications.

The feed forward capacitor $C3$ across $R1$ will significantly reduce the output noise.

TSOT23-5

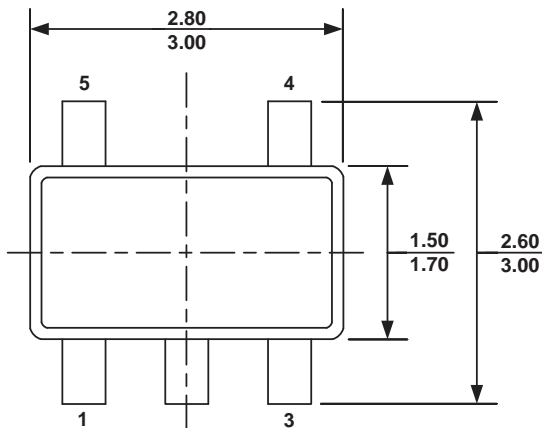

TOP VIEW

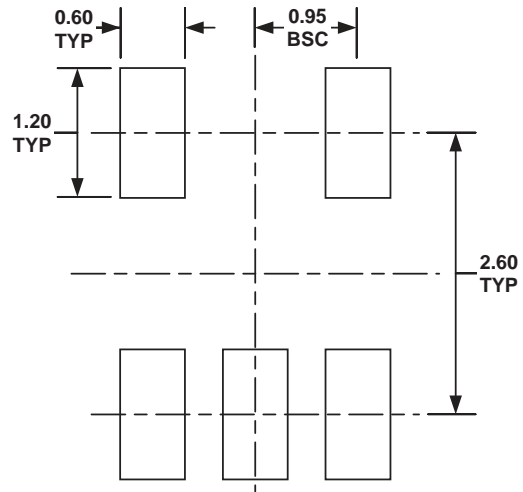

RECOMMENDED LAND PATTERN

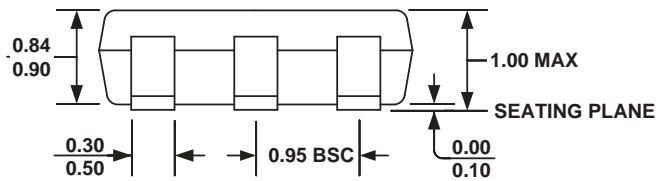

FRONT VIEW

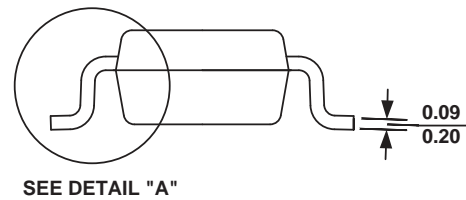

SIDE VIEW

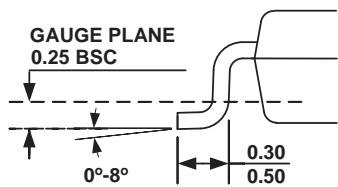

DETAIL A

NOTE:

- 1) ALL DIMENSIONS ARE IN MILLIMETERS.
- 2) PACKAGE LENGTH DOES NOT INCLUDE MOLD FLASH, PROTRUSION OR GATE BURR.
- 3) PACKAGE WIDTH DOES NOT INCLUDE INTERLEAD FLASH OR PROTRUSION.
- 4) LEAD COPLANARITY (BOTTOM OF LEADS AFTER FORMING) SHALL BE 0.10 MILLIMETERS MAX.
- 5) DRAWING CONFORMS TO JEDEC MO-193, VARIATION AA.
- 6) DRAWING IS NOT TO SCALE.

NOTICE: The information in this document is subject to change without notice. Users should warrant and guarantee that third party Intellectual Property rights are not infringed upon when integrating MPS products into any application. MPS will not assume any legal responsibility for any said applications.

Компания «Океан Электроники» предлагает заключение долгосрочных отношений при поставках импортных электронных компонентов на взаимовыгодных условиях!

Наши преимущества:

- Поставка оригинальных импортных электронных компонентов напрямую с производств Америки, Европы и Азии, а так же с крупнейших складов мира;
- Широкая линейка поставок активных и пассивных импортных электронных компонентов (более 30 млн. наименований);
- Поставка сложных, дефицитных, либо снятых с производства позиций;
- Оперативные сроки поставки под заказ (от 5 рабочих дней);
- Экспресс доставка в любую точку России;
- Помощь Конструкторского Отдела и консультации квалифицированных инженеров;
- Техническая поддержка проекта, помощь в подборе аналогов, поставка прототипов;
- Поставка электронных компонентов под контролем ВП;
- Система менеджмента качества сертифицирована по Международному стандарту ISO 9001;
- При необходимости вся продукция военного и аэрокосмического назначения проходит испытания и сертификацию в лаборатории (по согласованию с заказчиком);
- Поставка специализированных компонентов военного и аэрокосмического уровня качества (Xilinx, Altera, Analog Devices, Intersil, Interpoint, Microsemi, Actel, Aeroflex, Peregrine, VPT, Syfer, Eurofarad, Texas Instruments, MS Kennedy, Miteq, Cobham, E2V, MA-COM, Hittite, Mini-Circuits, General Dynamics и др.);

Компания «Океан Электроники» является официальным дистрибьютором и эксклюзивным представителем в России одного из крупнейших производителей разъемов военного и аэрокосмического назначения «JONHON», а так же официальным дистрибьютором и эксклюзивным представителем в России производителя высокотехнологичных и надежных решений для передачи СВЧ сигналов «FORSTAR».



JONHON

«JONHON» (основан в 1970 г.)

Разъемы специального, военного и аэрокосмического назначения:

(Применяются в военной, авиационной, аэрокосмической, морской, железнодорожной, горно- и нефтедобывающей отраслях промышленности)

«FORSTAR» (основан в 1998 г.)

ВЧ соединители, коаксиальные кабели,
кабельные сборки и микроволновые компоненты:

(Применяются в телекоммуникациях гражданского и специального назначения, в средствах связи, РЛС, а так же военной, авиационной и аэрокосмической отраслях промышленности).



Телефон: 8 (812) 309-75-97 (многоканальный)

Факс: 8 (812) 320-03-32

Электронная почта: ocean@oceanchips.ru

Web: <http://oceanchips.ru/>

Адрес: 198099, г. Санкт-Петербург, ул. Калинина, д. 2, корп. 4, лит. А