

FEATURES

- Optimized for dc to 3.75 Gbps data
- Programmable input equalization
 - Up to 22 dB boost at 1.875 GHz
 - Compensates up to 30 meters of CX4 cable up to 3.75 Gbps
 - Compensates up to 40 inches of FR4 up to 3.75 Gbps
- Programmable output pre-emphasis/de-emphasis
 - Up to 12 dB boost at 1.875 GHz (3.75 Gbps)
 - Compensates up to 15 meters of CX4 cable up to 3.75 Gbps
 - Compensates up to 40 inches of FR4 up to 3.75 Gbps
- Flexible 1.8 V to 3.3 V core supply
- Per lane P/N pair inversion for routing ease
- Low power: 125 mW/channel up to 3.75 Gbps
- DC- or ac-coupled differential CML inputs
- Programmable CML output levels
- 50 Ω on-chip termination
- Loss-of-signal detection
- Temperature range operation: -40°C to $+85^{\circ}\text{C}$
- Supports 8b10b, scrambled, or uncoded NRZ data
- I²C control interface
- 64-lead LFCSP (QFN) package

APPLICATIONS

- 10GBase-CX4
- HiGig™
- InfiniBand®
- 1 \times , 2 \times Fibre Channel
- XAUI™
- Gigabit Ethernet over backplane or cable
- CPRI™
- 50 Ω cables

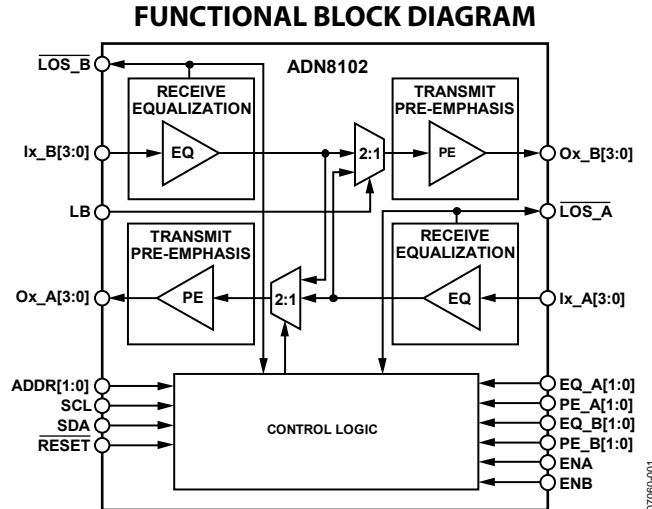

Figure 1.

GENERAL DESCRIPTION

The ADN8102 is a quad, bidirectional, CX4 cable/backplane equalizer with eight differential PECL-/CML-compatible inputs with programmable equalization and eight differential CML outputs with programmable output levels and pre-emphasis or de-emphasis. The operation of this device is optimized for NRZ data at rates up to 3.75 Gbps.

The receive inputs provide programmable equalization to compensate for up to 30 meters of CX4 cable (24 AWG) or 40 inches of FR4, and programmable pre-emphasis to compensate for up to 15 meters of CX4 cable (24 AWG) or 40 inches of FR4 at 3.75 Gbps. Each channel also provides programmable loss-of-signal detection and loopback capability for system testing and debugging.

The ADN8102 is controlled through toggle pins, an I²C® control interface that provides more flexible control, or a combination of both. Every channel implements an asynchronous path supporting dc to 3.75 Gbps NRZ data, fully independent of other channels. The ADN8102 has low latency and very low channel-to-channel skew.

The main application for the ADN8102 is to support switching in chassis-to-chassis applications over CX4 or InfiniBand cables.

The ADN8102 is packaged in a 9 mm \times 9 mm 64-lead LFCSP (QFN) package and operates from -40°C to $+85^{\circ}\text{C}$.

Rev. B

Information furnished by Analog Devices is believed to be accurate and reliable. However, no responsibility is assumed by Analog Devices for its use, nor for any infringements of patents or other rights of third parties that may result from its use. Specifications subject to change without notice. No license is granted by implication or otherwise under any patent or patent rights of Analog Devices. Trademarks and registered trademarks are the property of their respective owners.

TABLE OF CONTENTS

Features	1	Lane Inversion	18
Applications.....	1	Loopback	20
Functional Block Diagram	1	Transmitters	21
General Description	1	Selective Squelch and Disable.....	24
Revision History	2	I ² C Control Interface.....	25
Specifications.....	3	Serial Interface General Functionality.....	25
Timing Specifications	5	I ² C Interface Data Transfers—Data Write	25
Absolute Maximum Ratings.....	6	I ² C Interface Data Transfers—Data Read	26
ESD Caution.....	6	Applications Information	27
Pin Configuration and Function Descriptions.....	7	Output Compliance	27
Typical Performance Characteristics	9	Printed Circuit Board (PCB) Layout Guidelines	29
Theory of Operation	16	Register Map	31
Introduction	16	Outline Dimensions	33
Receivers	17	Ordering Guide	33
Equalization Settings.....	17		

REVISION HISTORY

10/10—Rev. A to Rev. B

Changes to Power Supply/Supply Current Parameter, Table 1 ...	4	Moved TxHeadroom and Figure 44.....	27
Added t _{RESET} Parameter and Note 1, Table 2 and Figure 3;		Changes to TxHeadroom and Figure 44	27
Renumbered Sequentially.....	5	Added Table 20	27
Added Junction Temperature Parameter, Table 3	6	Added Table 21	28
Changes to Introduction Section.....	16	Deleted Transmission Lines Section and Soldering Guidelines for Chip Scale Package Section.....	28
Added Table 5; Renumbered Sequentially	16	Changes to Printed Circuit Board (PCB) Layout Guidelines Section.....	29
Changes to Equalization Settings Section	17	Added Figure 45, Supply Sequencing Section, Thermal Paddle Design Section, and Figure 46	29
Added Table 7 and Advanced Equalization Settings Section ...	17	Added Stencil Design for the Thermal Paddle, Figure 47, and Figure 48	30
Changes to Table 8.....	18		
Added Table 12	20	8/08—Rev. 0 to Rev. A	
Changes to Loopback Section and Changes to Table 13	20	Changes to Features Section	1
Added Table 14	21	Changes to Loss of Signal/Signal Detect Section	18
Changes to Table 15.....	21	Added Recommended LOS Settings Section.....	18
Changes to Table 17.....	22	Deleted Figure 39; Renumbered Sequentially	18
Deleted High Current Setting and Output Level Shift Section.....	23	Exposed Paddle Notation Added to Outline Dimensions	31
Deleted Table 14; Renumbered Sequentially	24		
Changes to Table 18.....	24	5/08—Revision 0: Initial Version	
Added Table 19	24		
Deleted Table 15.....	25		
Added Applications Information Section and Output Compliance Section	27		

SPECIFICATIONS

$V_{CC} = 1.8\text{ V}$, $V_{EE} = 0\text{ V}$, $V_{TTI} = V_{TTO} = V_{CC}$, $R_L = 50\ \Omega$, differential output swing = 800 mV p-p differential, 3.75 Gbps, PRBS $2^7 - 1$, $T_A = 25^\circ\text{C}$, unless otherwise noted.

Table 1.

Parameter	Test Conditions/Comments	Min	Typ	Max	Unit
DYNAMIC PERFORMANCE					
Maximum Data Rate/Channel (NRZ)		3.75			Gbps
Deterministic Jitter	Data rate < 3.75 Gbps; BER = 1×10^{-12}		33		ps p-p
Random Jitter	$V_{CC} = 1.8\text{ V}$		1.5		ps rms
Residual Deterministic Jitter					
With Input Equalization	Data rate < 3.25 Gbps; 0 inches to 40 inches FR4		0.20		UI
	Data rate < 3.25 Gbps; 0 meters to 30 meters CX4		0.19		UI
	Data rate < 3.75 Gbps; 0 inches to 40 inches FR4		0.24		UI
	Data rate < 3.75 Gbps; 0 meters to 30 meters CX4		0.21		UI
With Output Pre-Emphasis	Data rate < 3.25 Gbps; 0 inches to 40 inches FR4		0.13		UI
	Data rate < 3.25 Gbps; 0 meters to 15 meters CX4		0.37		UI
	Data rate < 3.75 Gbps; 0 inches to 40 inches FR4		0.14		UI
	Data rate < 3.75 Gbps; 0 meters to 15 meters CX4		0.41		UI
Output Rise/Fall Time	20% to 80%		75		ps
Propagation Delay			1		ns
Channel-to-Channel Skew			50		ps
OUTPUT PRE-EMPHASIS					
Equalization Method	1-tap programmable pre-emphasis				
Maximum Boost	800 mV p-p output swing		6		dB
	200 mV p-p output swing		12		dB
Pre-Emphasis Tap Range	Minimum		2		mA
	Maximum		12		mA
INPUT EQUALIZATION					
Minimum Boost	EQBY = 1		1.5		dB
Maximum Boost	Maximum boost occurs at 1.875 GHz		22		dB
Number of Equalization Settings			8		
Gain Step Size			2.5		dB
INPUT CHARACTERISTICS					
Input Voltage Swing	Differential, $V_{ICM}^1 = V_{CC} - 0.6\text{ V}$	300		2000	mV p-p
Input Voltage Range	Single-ended absolute voltage level, V_L minimum		$V_{EE} + 0.4$		V p-p
	Single-ended absolute voltage level, V_H maximum		$V_{CC} + 0.5$		V p-p
Input Resistance	Single-ended	45	50	55	Ω
Input Return Loss	Measured at 2.5 GHz		5		dB
OUTPUT CHARACTERISTICS					
Output Voltage Swing	DC, differential, PE = 0, default, $V_{CC} = 1.8\text{ V}$	635	740	870	mV p-p
	DC, differential, PE = 0, default, $V_{CC} = 3.3\text{ V}$		800		mV p-p
	DC, differential, PE = 0, minimum output level, ² $V_{CC} = 1.8\text{ V}$		100		mV p-p
	DC, differential, PE = 0, minimum output level, ² $V_{CC} = 3.3\text{ V}$		100		mV p-p
	DC, differential, PE = 0, maximum output level, ² $V_{CC} = 1.8\text{ V}$		1300		mV p-p
	DC, differential, PE = 0, maximum output level, ² $V_{CC} = 3.3\text{ V}$		1800		mV p-p

ADN8102

Parameter	Test Conditions/Comments	Min	Typ	Max	Unit
Output Voltage Range	Single-ended absolute voltage level, TxHeadroom = 0; V_L minimum		$V_{CC} - 1.1$		V
	Single-ended absolute voltage level, TxHeadroom = 0; V_H maximum		$V_{CC} + 0.6$		V
	Single-ended absolute voltage level, TxHeadroom = 1; V_L minimum		$V_{CC} - 1.2$		V
	Single-ended absolute voltage level, TxHeadroom = 1; V_H maximum		$V_{CC} + 0.6$		V
Output Current	Minimum output current per channel		2		mA
	Maximum output current per channel, $V_{CC} = 1.8$ V		21		mA
Output Resistance	Single-ended	43	50	57	Ω
Output Return Loss	Measured at 2.5 GHz		5		dB
LOS CHARACTERISTICS					
Assert Level	IN_A/IN_B LOS threshold = 0x0C		20		mV diff
Deassert Level	IN_A/IN_B LOS hysteresis = 0x0D		225		mV diff
POWER SUPPLY					
Operating Range					
V_{CC}	$V_{EE} = 0$ V	1.7	1.8	3.6	V
DV_{CC}	$V_{EE} = 0$ V, $DV_{CC} \leq (V_{CC} + 1.3$ V)	3.0	3.3	3.6	V
V_{TTI}	$(V_{EE} + 0.4$ V + $0.5 \times V_{ID}) < V_{TTI} < (V_{CC} + 0.5$ V)	$V_{EE} + 0.4$	1.8	3.6	V
V_{TTO}	$(V_{CC} - 1.1$ V + $0.5 \times V_{OD}) < V_{TTO} < (V_{CC} + 0.5$ V)	$V_{CC} - 1.1$	1.8	3.6	V
Supply Current					
I_{TTO}	$V_{TTO} = 1.8$ V, all outputs enabled		63	69	mA
I_{CC}	$V_{CC} = 1.8$ V, all outputs enabled		460	565	mA
LOGIC CHARACTERISTICS					
Input High, V_{IH}	$DV_{CC} = 3.3$ V	2.5			V
Input Low, V_{IL}				1.0	V
Output High, V_{OH}		2.5			V
Output Low, V_{OL}				1.0	V
THERMAL CHARACTERISTICS					
Operating Temperature Range		-40		+85	$^{\circ}$ C
θ_{JA}			22		$^{\circ}$ C/W

¹ V_{ICM} is the input common-mode voltage.

² Programmable via I²C.

TIMING SPECIFICATIONS

Table 2. I²C Timing Parameters

Parameter	Min	Max	Unit	Description
f _{SCL}	0	400	kHz	SCL clock frequency
t _{HD:STA}	0.6	Not applicable	μs	Hold time for a start condition
t _{SU:STA}	0.6	Not applicable	μs	Setup time for a repeated start condition
t _{LOW}	1.3	Not applicable	μs	Low period of the SCL clock
t _{HIGH}	0.6	Not applicable	μs	High period of the SCL clock
t _{HD:DAT}	0	Not applicable	μs	Data hold time
t _{SU:DAT}	10	Not applicable	ns	Data setup time
t _R	1	300	ns	Rise time for both SDA and SCL
t _F	1	300	ns	Fall time for both SDA and SCL
t _{SU:STO}	0.6	Not applicable	μs	Setup time for a stop condition
t _{BUF}	1	Not applicable	ns	Bus free time between a stop and a start condition
C _{IO}	5	7	pF	Capacitance for each I/O pin
t _{RESET}	10	Not applicable	ns	Reset pulse width ¹

¹ Reset pulse width is defined as the time $\overline{\text{RESET}}$ is held below the logic low threshold (V_{IL}) listed in Table 1 while the DV_{CC} supply is within the operating range in Table 1.

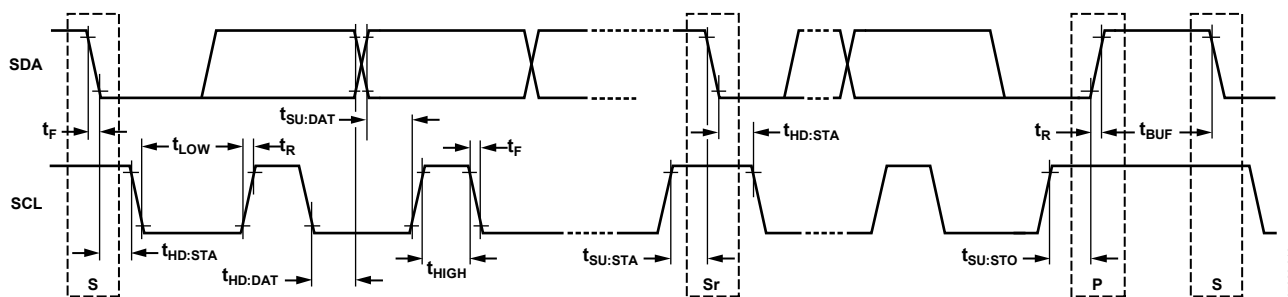

Figure 2. I²C Timing Diagram

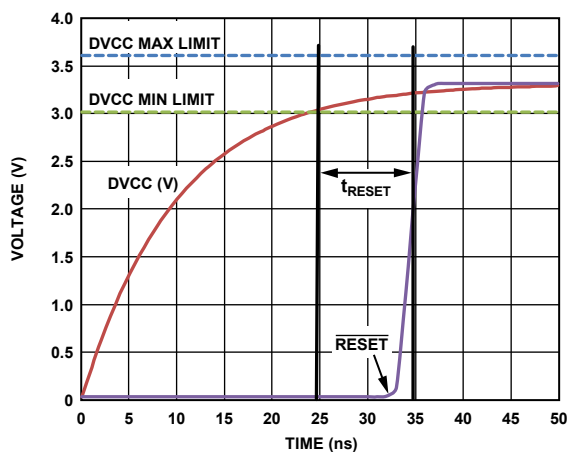

Figure 3. Reset Timing Diagram

ABSOLUTE MAXIMUM RATINGS

Table 3.

Parameter	Rating
V_{CC} to V_{EE}	3.7 V
V_{TI}	$V_{CC} + 0.6 V$
V_{TO}	$V_{CC} + 0.6 V$
Internal Power Dissipation	4.26 W
Differential Input Voltage	2.0 V
Logic Input Voltage	$V_{EE} - 0.3 V < V_{IN} < V_{CC} + 0.6 V$
Storage Temperature Range	-65°C to +125°C
Lead Temperature	300°C
Junction Temperature	125°C

Stresses above those listed under Absolute Maximum Ratings may cause permanent damage to the device. This is a stress rating only; functional operation of the device at these or any other conditions above those indicated in the operational section of this specification is not implied. Exposure to absolute maximum rating conditions for extended periods may affect device reliability.

ESD CAUTION



ESD (electrostatic discharge) sensitive device. Charged devices and circuit boards can discharge without detection. Although this product features patented or proprietary protection circuitry, damage may occur on devices subjected to high energy ESD. Therefore, proper ESD precautions should be taken to avoid performance degradation or loss of functionality.

PIN CONFIGURATION AND FUNCTION DESCRIPTIONS

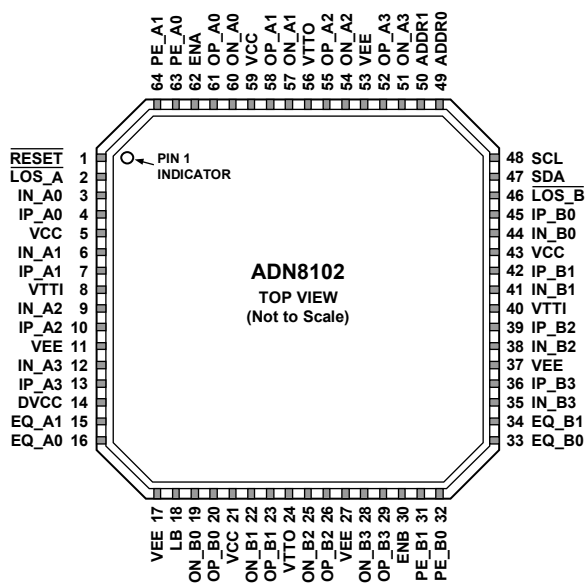

NOTES
1. EXPOSED PAD MUST BE CONNECTED TO VEE.

Figure 4. Pin Configuration

Table 4. Pin Function Descriptions

Pin No.	Mnemonic	Type	Description
1	RESET	Control	Reset Input, Active Low
2	LOS_A	Digital I/O	Port A Loss of Signal Status, Active Low
3	IN_A0	I/O	High Speed Input Complement
4	IP_A0	I/O	High Speed Input
5	VCC	Power	Positive Supply
6	IN_A1	I/O	High Speed Input Complement
7	IP_A1	I/O	High Speed Input
8	VTTI	Power	Input Termination Supply
9	IN_A2	I/O	High Speed Input Complement
10	IP_A2	I/O	High Speed Input
11	VEE	Power	Negative Supply
12	IN_A3	I/O	High Speed Input Complement
13	IP_A3	I/O	High Speed Input
14	DVCC	Power	Digital Power Supply
15	EQ_A1	Control	Port A Input Equalization MSB
16	EQ_A0	Control	Port A Input Equalization LSB
17	VEE	Power	Negative Supply
18	LB	Control	Loopback Control
19	ON_B0	I/O	High Speed Output Complement
20	OP_B0	I/O	High Speed Output
21	VCC	Power	Positive Supply
22	ON_B1	I/O	High Speed Output Complement
23	OP_B1	I/O	High Speed Output
24	VTTO	Power	Output Termination Supply
25	ON_B2	I/O	High Speed Output Complement
26	OP_B2	I/O	High Speed Output
27	VEE	Power	Negative Supply

ADN8102

Pin No.	Mnemonic	Type	Description
28	ON_B3	I/O	High Speed Output Complement
29	OP_B3	I/O	High Speed Output
30	ENB	Control	Port B Enable
31	PE_B1	Control	Port B Output Pre-Emphasis MSB
32	PE_B0	Control	Port B Output Pre-Emphasis LSB
33	EQ_B0	Control	Port B Input Equalization LSB
34	EQ_B1	Control	Port B Input Equalization MSB
35	IN_B3	I/O	High Speed Input Complement
36	IP_B3	I/O	High Speed Input
37	VEE	Power	Negative Supply
38	IN_B2	I/O	High Speed Input Complement
39	IP_B2	I/O	High Speed Input
40	VTTI	Power	Input Termination Supply
41	IN_B1	I/O	High Speed Input Complement
42	IP_B1	I/O	High Speed Input
43	VCC	Power	Positive Supply
44	IN_B0	I/O	High Speed Input Complement
45	IP_B0	I/O	High Speed Input
46	$\overline{\text{LOS}}_B$	Digital I/O	Port B Loss of Signal Status, Active Low
47	SDA	Control	I ² C Control Interface Data Input/Output
48	SCL	Control	I ² C Control Interface Clock Input
49	ADDR0	Control	I ² C Control Interface Address LSB
50	ADDR1	Control	I ² C Control Interface Address MSB
51	ON_A3	I/O	High Speed Output Complement
52	OP_A3	I/O	High Speed Output
53	VEE	Power	Negative Supply
54	ON_A2	I/O	High Speed Output Complement
55	OP_A2	I/O	High Speed Output
56	V TTO	Power	Output Termination Supply
57	ON_A1	I/O	High Speed Output Complement
58	OP_A1	I/O	High Speed Output
59	VCC	Power	Positive Supply
60	ON_A0	I/O	High Speed Output Complement
61	OP_A0	I/O	High Speed Output
62	ENA	Control	Port A Enable
63	PE_A0	Control	Port A Output Pre-Emphasis LSB
64	PE_A1	Control	Port A Output Pre-Emphasis MSB
EP	EPAD	Power	EPAD Must Be Connected to VEE

TYPICAL PERFORMANCE CHARACTERISTICS

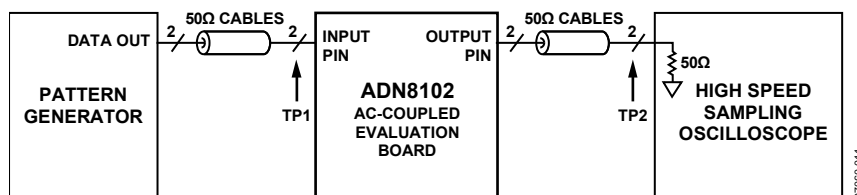

Figure 5. Standard Test Circuit (No Channel)

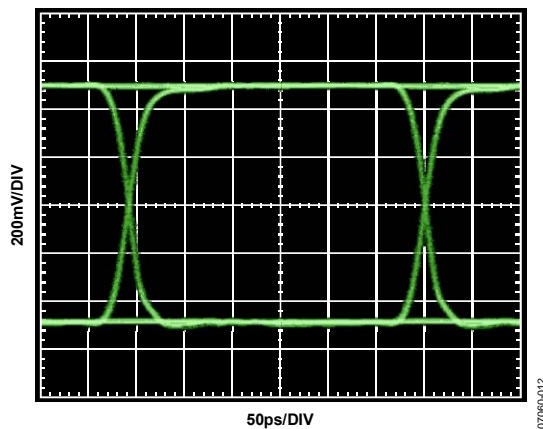

Figure 6. 3.25 Gbps Input Eye (TP1 from Figure 5)

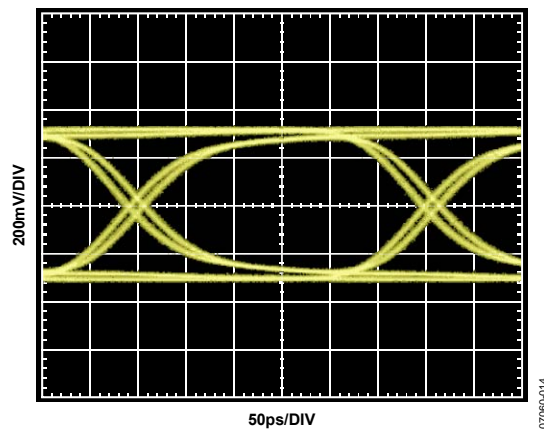

Figure 8. 3.25 Gbps Output Eye, No Channel (TP2 from Figure 5)

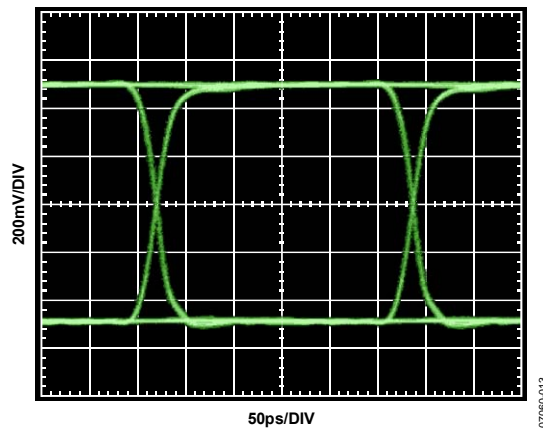

Figure 7. 3.75 Gbps Input Eye (TP1 from Figure 5)

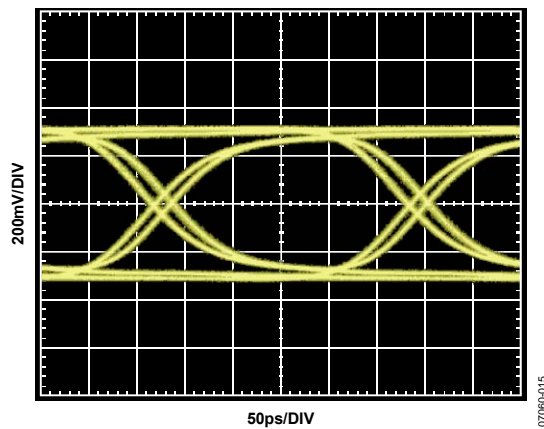

Figure 9. 3.75 Gbps Output Eye, No Channel (TP2 from Figure 5)

ADN8102

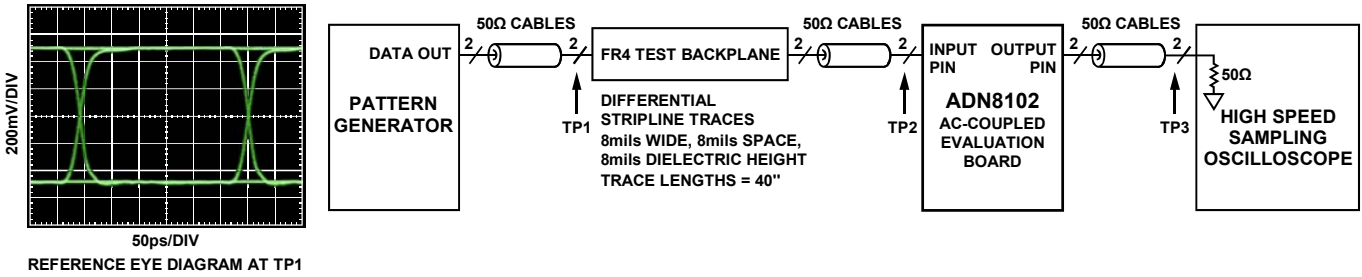

Figure 10. Input Equalization Test Circuit, FR4

07060-016

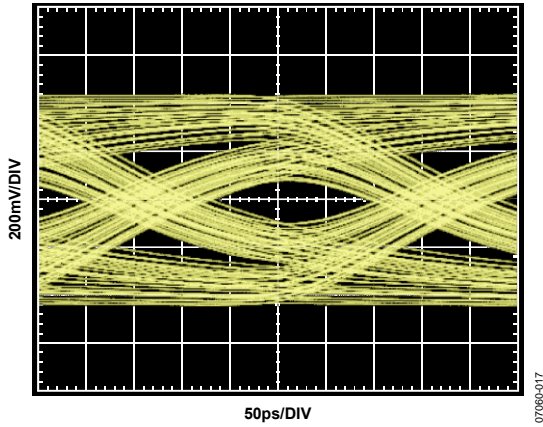

Figure 11. 3.25 Gbps Input Eye, 40 Inch FR4 Input Channel (TP2 from Figure 10)

07060-017

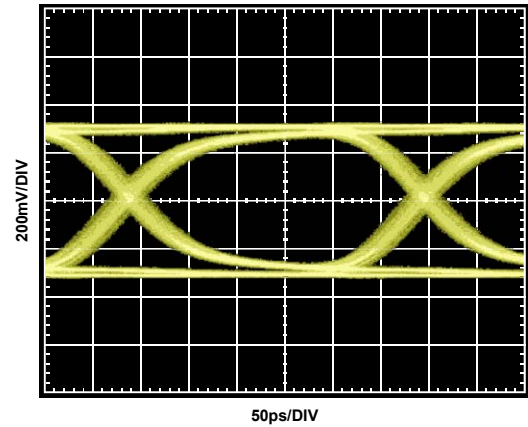

Figure 13. 3.25 Gbps Output Eye, 40 Inch FR4 Input Channel, Best EQ Setting (TP3 from Figure 10)

07060-019

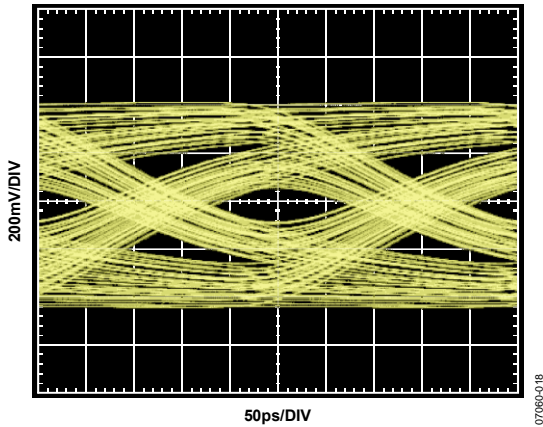

Figure 12. 3.75 Gbps Input Eye, 40 Inch FR4 Input Channel (TP2 from Figure 10)

07060-018

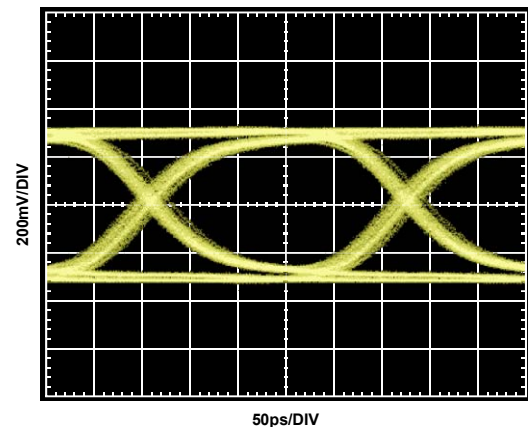

Figure 14. 3.75 Gbps Output Eye, 40 Inch FR4 Input Channel, Best EQ Setting (TP3 from Figure 10)

07060-020

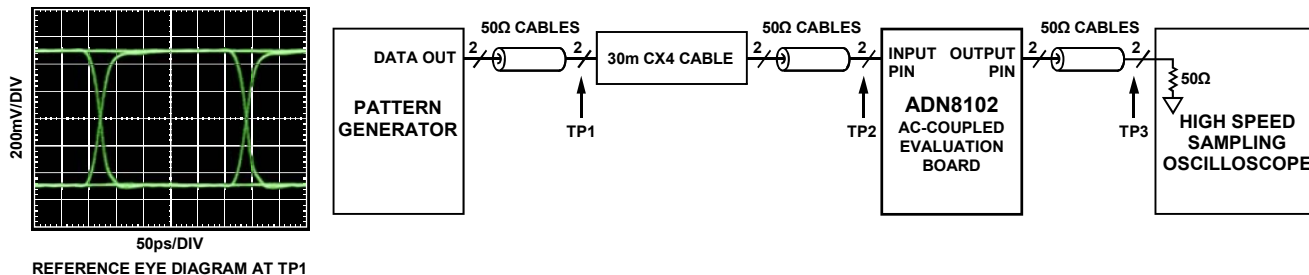

Figure 15. Input Equalization Test Circuit, CX4

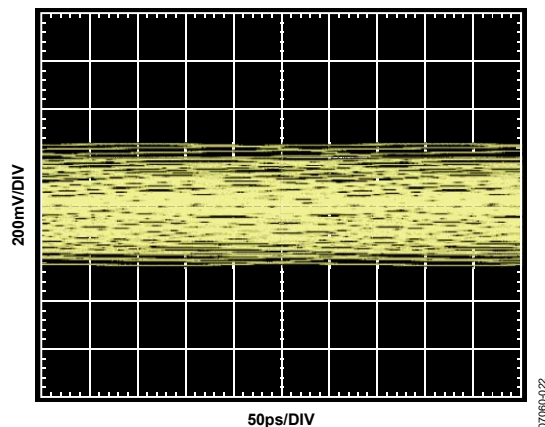

Figure 16. 3.25 Gbps Input Eye, 30 Meters CX4 Cable (TP2 from Figure 15)

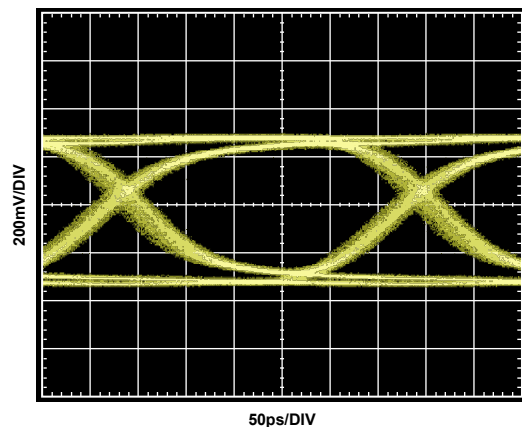

Figure 18. 3.25 Gbps Output Eye, 30 Meters CX4 Cable, Best EQ Setting (TP3 from Figure 15)

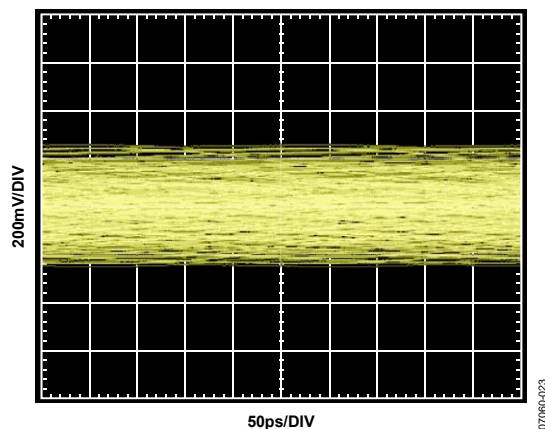

Figure 17. 3.75 Gbps Input Eye, 30 Meters CX4 Cable (TP2 from Figure 15)

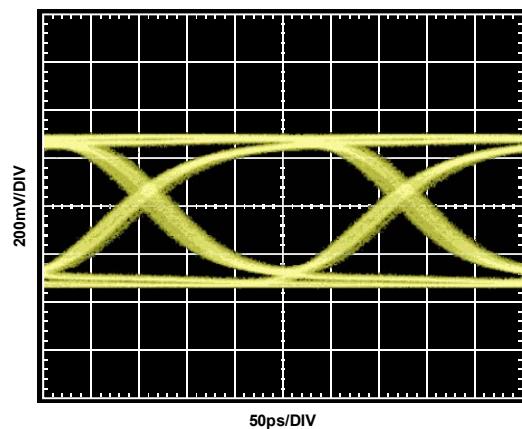

Figure 19. 3.75 Gbps Output Eye, 30 Meters CX4 Cable, Best EQ Setting (TP3 from Figure 15)

ADN8102

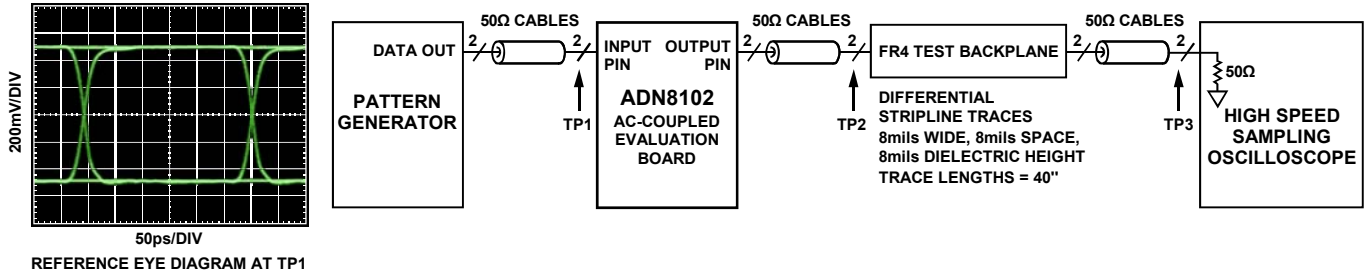

Figure 20. Output Pre-Emphasis Test Circuit, FR4

07060-026

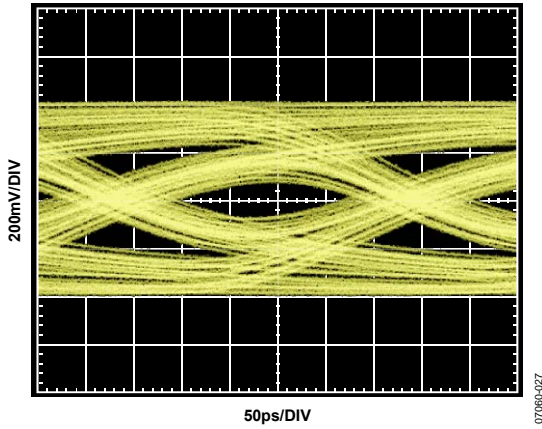

Figure 21. 3.25 Gbps Output Eye, 40 Inch FR4 Output Channel, PE = 0 (TP3 from Figure 20)

07060-027

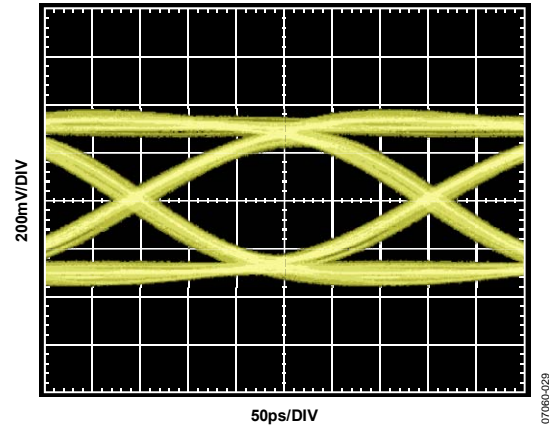

Figure 23. 3.25 Gbps Output Eye, 40 Inch FR4 Output Channel, PE = Best Setting (TP3 from Figure 20)

07060-029

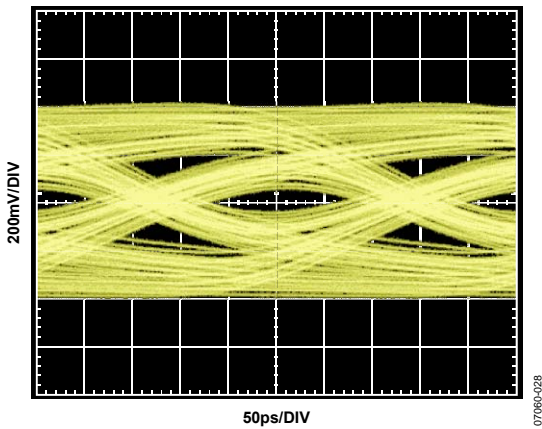

Figure 22. 3.75 Gbps Output Eye, 40 Inch FR4 Output Channel, PE = 0 (TP3 from Figure 20)

07060-028

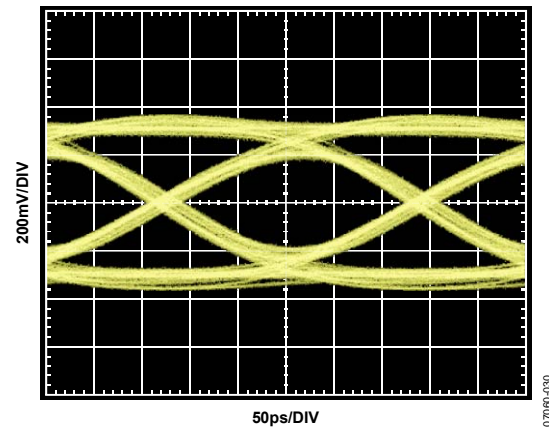

Figure 24. 3.75 Gbps Output Eye, 40 Inch FR4 Output Channel, PE = Best Setting (TP3 from Figure 20)

07060-030

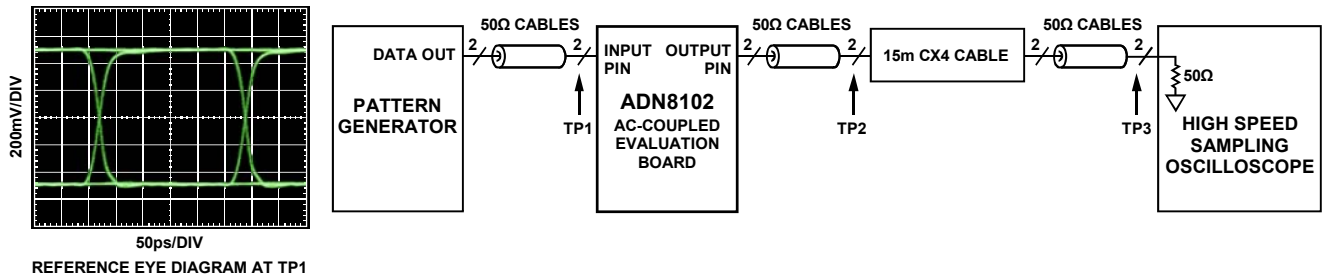

Figure 25. Output Pre-Emphasis Test Circuit, CX4

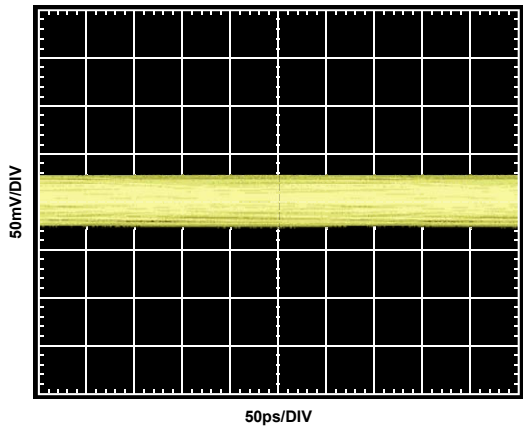

Figure 26. 3.25 Gbps Output Eye, 15 Meters CX4 Cable, PE = 0 (TP3 from Figure 25)

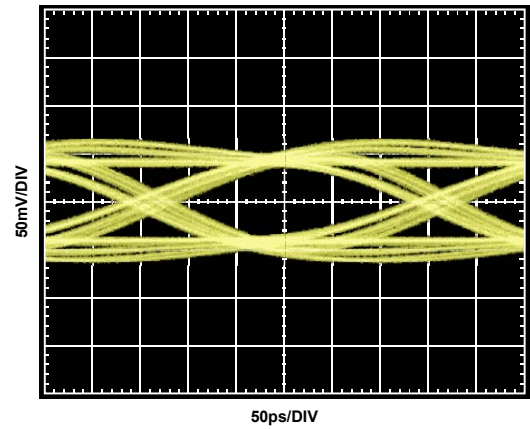

Figure 28. 3.25 Gbps Output Eye, 15 Meters CX4 Cable, PE = Best Setting (TP3 from Figure 25)

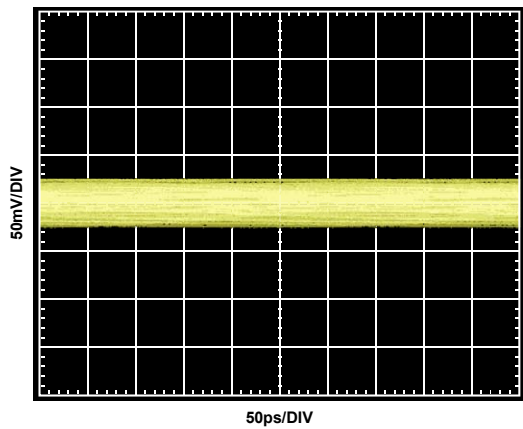

Figure 27. 3.75 Gbps Output Eye, 15 Meters CX4 Cable, PE = 0 (TP3 from Figure 25)

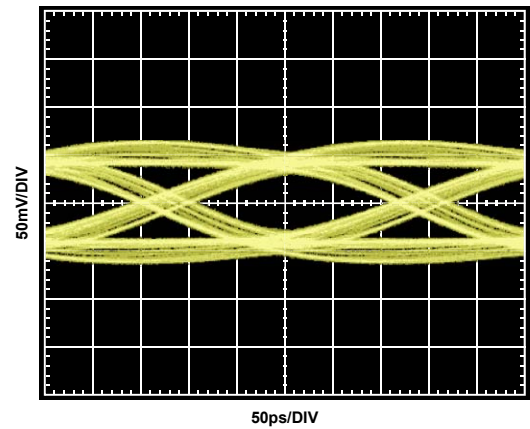

Figure 29. 3.75 Gbps Output Eye, 15 Meters CX4 Cable, PE = Best Setting (TP3 from Figure 25)

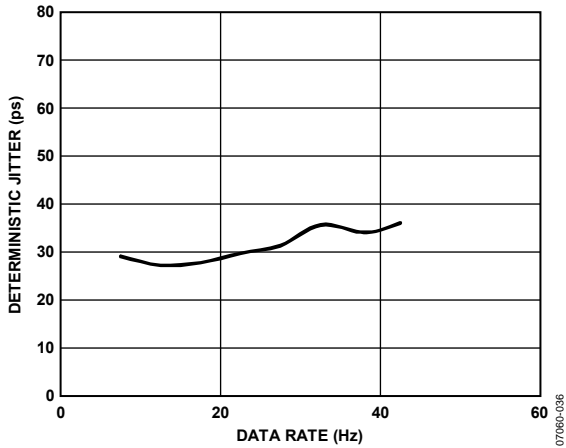

Figure 30. Deterministic Jitter vs. Data Rate

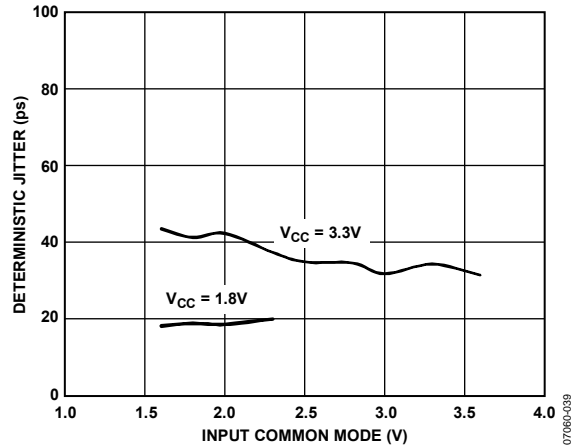

Figure 33. Deterministic Jitter vs. Input Common Mode

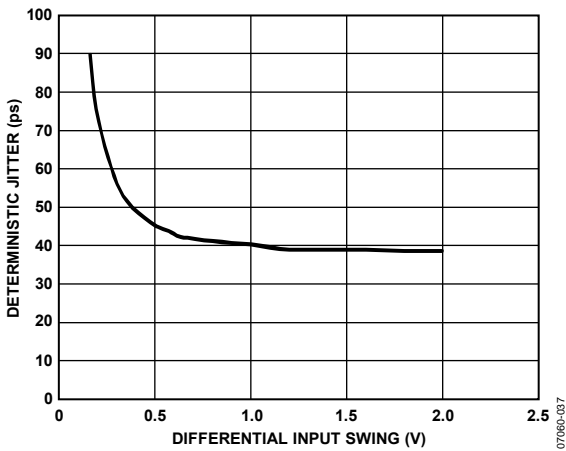

Figure 31. Deterministic Jitter vs. Differential Input Swing

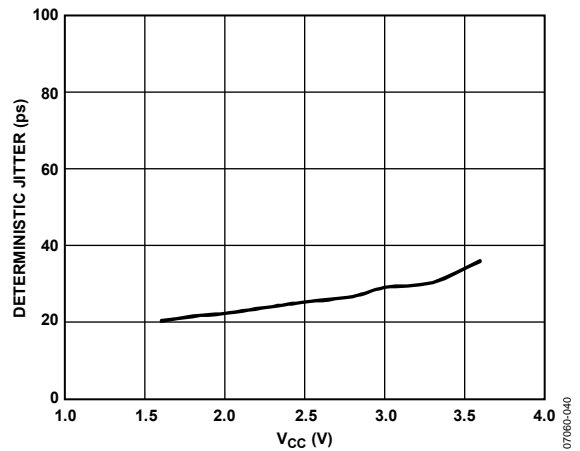

Figure 34. Deterministic Jitter vs. Supply Voltage (V_{CC})

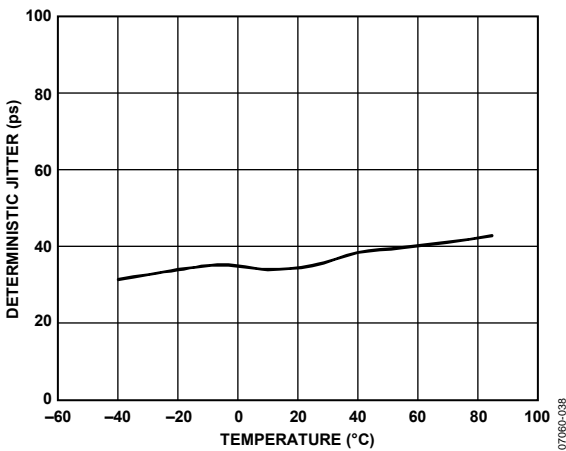

Figure 32. Deterministic Jitter vs. Temperature

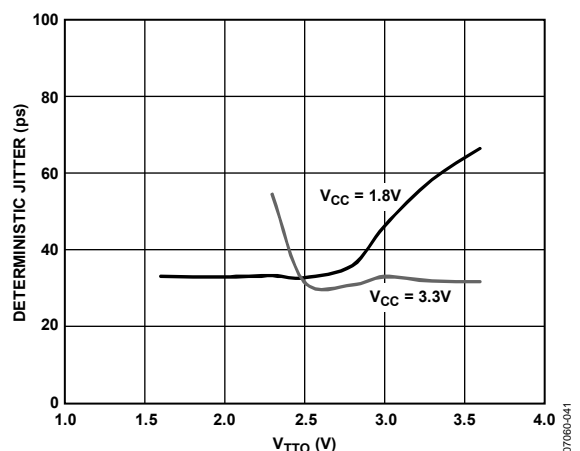

Figure 35. Deterministic Jitter vs. Output Termination Voltage (V_{TT0})

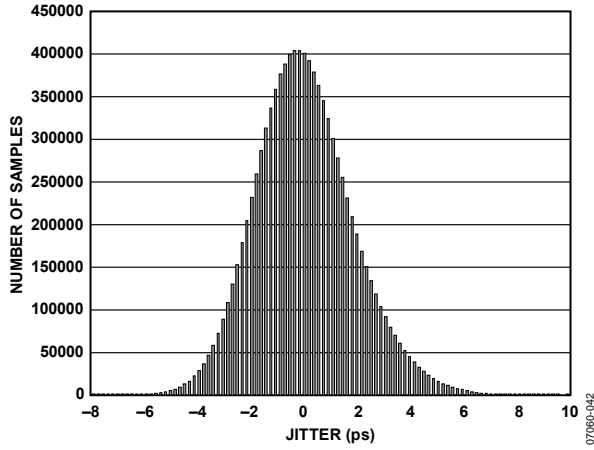

Figure 36. Random Jitter Histogram

07060-042

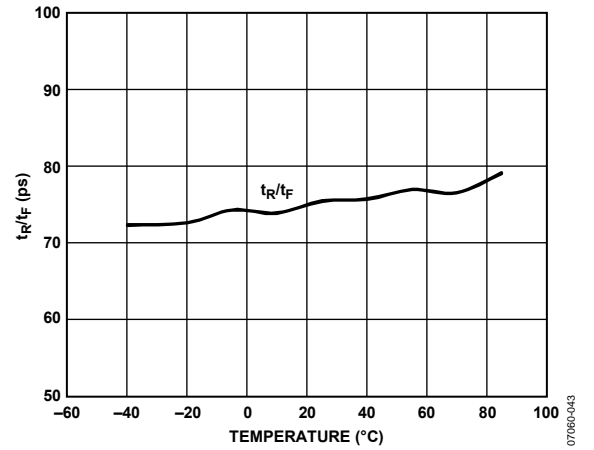

Figure 37. Rise Time (t_R)/Fall Time (t_F) vs. Temperature

07060-043

ADN8102

THEORY OF OPERATION

INTRODUCTION

The ADN8102 is a quad, bidirectional cable and backplane equalizer that provides both input equalization and output pre-emphasis on both the line card and cable sides of the device. The device supports full loopback and through connectivity of the two unidirectional half-links, each consisting of four differential signal pairs.

The ADN8102 offers extensively programmable output levels and pre-emphasis as well as the ability to disable the output current. The receivers integrate a programmable, multizero equalizer transfer function that is optimized to compensate either typical backplane or typical cable losses.

The I/O on-chip termination resistors are terminated to user-settable supplies to support dc coupling in a wide range of logic styles. The ADN8102 supports a wide core supply range; V_{CC} can be set from 1.8 V to 3.3 V. These features, together with programmable output levels, allow for a wide range of dc- and ac-coupled I/O configurations.

The ADN8102 supports several control and configuration modes, as shown in Table 5. The pin control mode offers access to a subset of the total feature list but allows for a much simplified control scheme. The primary advantage of using the serial control interface is that it allows finer resolution in setting receive equalization, transmitter preemphasis, loss-of-signal (LOS) behavior, and output levels.

By default, the ADN8102 starts in pin control mode. Strobing the **RESET** pin sets all on-chip registers to their default values and uses pins to configure loopback, PE, and EQ levels. In

mixed mode, loopback is still controlled through the external pin. The user can override PE and EQ settings in mixed mode. In serial mode, all functions are accessed through registers, and the control pin inputs are ignored, except **RESET**.

The ADN8102 register set is controlled through a 2-wire, I²C interface. The ADN8102 acts only as an I²C slave device. The 7-bit slave address for the ADN8102 I²C interface contains the static value b10010 for the upper four bits. The lower two bits are controlled by the input pins, ADDR[1:0]

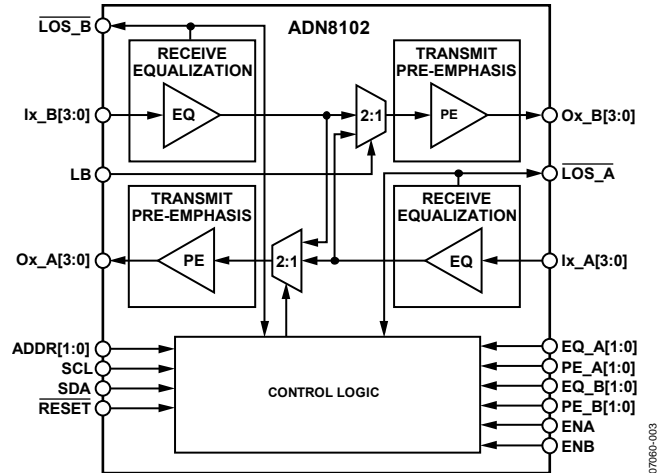

Figure 38. Simplified Functional Block Diagram

Table 5. Control Interface Mode Register

Address	Default	Register Name	Bit	Bit Name	Functionality Description
0x0F	0x00	Control interface mode	7:2 1:0	Reserved MODE[1:0]	Set to 0. 00 = toggle pin control. Asynchronous control through toggle pins only. 01 = Loopback control via toggle pins, equalization, and preemphasis via register-based control through the I ² C serial interface. 10 = Equalization and preemphasis via toggle pins and loopback control via register-based control through the I ² C serial interface. 11 = serial control. Register-based control through the I ² C serial interface.

RECEIVERS

Input Structure and Input Levels

The ADN8102 receiver inputs incorporate 50 Ω termination resistors, ESD protection, and a multizero transfer function equalizer that can be optimized for backplane or cable operation. Each channel also provides a programmable LOS function that provides an interrupt that can be used to squelch or disable the associated output when the differential input voltage falls below the programmed threshold value. Each receive channel also provides a P/N inversion function that allows the user to swap the sign of the input signal path to eliminate the need for board-level crossovers in the receiver channel.

Table 6 illustrates some, but not all, possible combinations of input supply voltages.

Table 6. Common Input Voltage Levels

Configuration	V _{CC} (V)	V _{TTI} (V)
Low V _{TTI} , ac-coupled input	1.8	1.6
Single 1.8 V supply	1.8	1.8
3.3 V core	3.3	1.8
Single 3.3 V supply	3.3	3.3

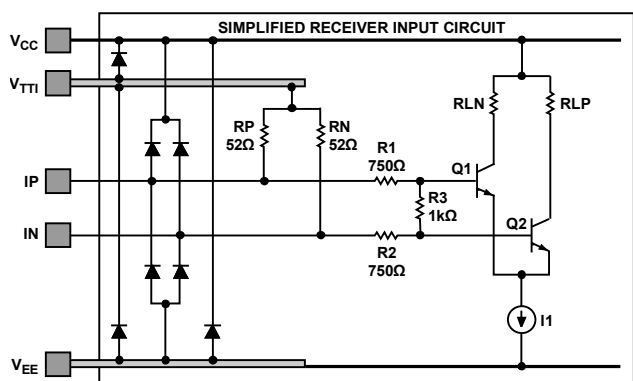

Figure 39. Simplified Input Structure

EQUALIZATION SETTINGS

The ADN8102 receiver incorporates a multizero transfer function, continuous time equalizer that provides up to 22 dB of high frequency boost at 1.875 GHz to compensate up to 30 meters of CX4 cable or 40 inches of FR4 at 3.75 Gbps. The ADN8102 allows joint control of the equalizer transfer function of the four equalizer channels in a single port through the I²C control interface. Port A and Port B equalizer transfer functions are controlled via Register 0x80 and Register 0xA0, respectively. The equalizer transfer function allows independent control of the boost in two different frequency ranges for optimal matching with the loss shape of the user’s channel (for example, skin-effect loss dominated or dielectric loss dominated). By default, the equalizer control is simplified to two independent look up tables (LUT) of basic settings that provide nine settings, each optimized for CX4 cable and FR4 to ease programming for

typical channels. The default state of the part selects the CX4 optimized equalization map for the IN_A[3:0] channels that interface with the cable and the FR4 optimized equalization map for the IN_B[3:0] channels that interface with the board. Full control of the equalizer is available via the I²C control interface by writing MODE[0] = 1 at Address 0x0F. Table 8 summarizes the high frequency boost for each of the basic control settings and the typical length of CX4 cable and FR4 trace that each setting compensates. Setting the EQBY bit of the IN_A/IN_B configuration registers high sets the equalization to 1.5 dB of boost, which compensates 0 meters to 2 meters of CX4 or 0 inches to 5 inches of FR4.

Setting the LUT SELECT bit = 1 (Bit 1 in the IN_Ax/IN_Bx FR4 control registers) allows the default map selection (CX4 or FR4 optimized) to be overwritten via the LUT FR4/CX4 bit (Bit 0) in the IN_Ax/IN_Bx FR4 control registers. Setting this bit high selects the FR4 optimized map, and setting it low selects the CX4 optimized map. These settings are set on a per channel basis (see Table 9 and Table 22).

Table 7.

LUT SELECT	LUT FR4/CX4	Description
0 (default)	X ¹	Port A eq optimized for CX4 cable Port B eq optimized for FR4 PCB trace
1	0	Eq optimized for CX4 cable
1	1	Eq optimized for FR4 PCB trace

¹ X = don't care.

Advanced Equalization Settings

The user can also specify the boost in the midfrequency and high frequency ranges independently. This is done by writing to the IN_A/IN_B EQ1 control and IN_A/IN_B EQ2 control registers for the channel of interest. Each of these registers provides 32 settings of boost, with IN_A/IN_B EQ1 control setting the midfrequency boost and IN_A/IN_B EQ2 control setting the high frequency boost. The IN_A/IN_B EQx control registers are ordered such that Bit 5 is a sign bit, and midlevel boost is centered on 0x00; setting Bit 5 low and increasing the LSBs results in decreasing boost, while setting Bit 5 high and increasing the LSBs results in increasing boost. The EQ CTL SRC bit (Bit 6) in the IN_A/IN_B EQ1 control registers determines whether the equalization control for the channel of interest is selected from the optimized map or directly from the IN_A/IN_B EQx control registers (per port). Setting this bit high selects equalization control directly from the IN_A/IN_B EQx control registers, and setting it low selects equalization control from the selected optimized map.

Table 8. Receive Equalizer Boost vs. Setting (CX4 and FR4 Optimized Maps)

EQ_A[1:0] and EQ_B[1:0] Pins	IN_Ax/IN_Bx Configuration, EQ[2:0]	EQBY	Cable Optimized		FR4 Optimized	
			Boost (dB)	Typical CX4 Cable Length (Meters)	Boost (dB)	Typical FR4 Trace Length (Inches)
0	X ¹	1	1.5	< 2	1.5	< 5
	0	0	10	2 to 6	3.5	5 to 10
	1	0	12	8 to 10	3.9	10 to 15
1	2	0	14	12 to 14	4.25	15 to 20
	3	0	17	16 to 18	4.5	20 to 25
	4	0	19	20 to 22	4.75	25 to 30
2	5	0	20	24 to 26	5.0	30 to 35
	6	0	21	28 to 30	5.3	35 to 40
3	7	0	22	30 to 32	5.5	35 to 40

¹ X = Don't care

Table 9. Receive Configuration and Equalization Registers

Name	Address	Bit 7	Bit 6	Bit 5	Bit 4	Bit 3	Bit 2	Bit 1	Bit 0	Default
IN_A/IN_B configuration	0x80, 0xA0		PNSWAP	EQBY	EN		EQ[2]	EQ[1]	EQ[0]	0x30
IN_A/IN_B EQ1 control	0x83, 0xA3		EQ CTL SRC	EQ1[5]	EQ1[4]	EQ1[3]	EQ1[2]	EQ1[1]	EQ1[0]	0x00
IN_A/IN_B EQ2 control	0x84, 0xA4			EQ2[5]	EQ2[4]	EQ2[3]	EQ2[2]	EQ2[1]	EQ2[0]	0x00
IN_Ax/IN_Bx FR4 control	0x85, 0x8D, 0x95, 0x9D, 0xA5, 0xAD, 0xB5, 0xBD							LUT SELECT	LUT FR4/CX4	0x00

Loss of Signal/Signal Detect

An independent signal detect output is provided for all eight input ports of the device. The signal-detect function measures the low frequency amplitude of the signal at the receiver input and compares this measurement with a defined threshold level. If the measurement indicates that the input signal swing is smaller than the threshold for 250 μ s, the channel indicates a loss-of-signal event. Assertion and deassertion of the LOS signal occurs within 100 μ s of the event.

The LOS-assert and LOS-deassert levels are set on a per channel basis through the I²C control interface, by writing to the IN_A/IN_B LOS threshold and IN_A/IN_B LOS hysteresis registers, respectively. The recommended settings are IN_A/IN_B LOS threshold = 0x0C and IN_A/IN_B LOS hysteresis = 0x0D. All ports are factory tested with these settings to ensure that an LOS event is asserted for single-ended dc input swings less than 20 mV and is deasserted for single-ended dc input swings greater than 225 mV.

The LOS status for each individual channel can be accessed through the I²C control interface. The independent channel LOS status can be read from the IN_A/IN_B LOS status registers (Address 0x1F and Address 0x3F). The four LSBs of each register represent the current LOS status of each channel, with high representing an ongoing LOS event. The four MSBs of each

register represent the historical LOS status of each channel, with high representing a LOS event at any time on a specific channel. The MSBs are sticky and remain high once asserted until cleared by the user by overwriting the bits to 0.

Recommended LOS Settings

Recommended settings for LOS are as follows:

- Set IN_A/IN_B LOS threshold to 0x0C for an assert voltage of 20 mV differential (40 mV p-p differential).
- Set IN_A/IN_B LOS hysteresis to 0x0D for a deassert voltage of 225 mV differential (450 mV p-p differential).

LANE INVERSION

The input P/N inversion is a feature intended to allow the user to implement the equivalent of a board-level crossover in a much smaller area and without additional via impedance discontinuities that degrade the high frequency integrity of the signal path. The P/N inversion is available on a per port basis and is controlled through the I²C control interface. The P/N inversion is accomplished by writing to the PNSWAP bit (Bit 6) of the IN_A/IN_B configuration register (see Table 9) with low representing a noninverting configuration and high representing an inverting configuration. Note that using this feature to account for signal inversions downstream of the receiver requires additional attention when switching connectivity.

Table 10. LOS Threshold and Hysteresis Control Registers

Name	Address	Bit 7	Bit 6	Bit 5	Bit 4	Bit 3	Bit 2	Bit 1	Bit 0	Default
IN_A/IN_B LOS threshold	0x81, 0xA1		THRESH[6]	THRESH[5]	THRESH[4]	THRESH[3]	THRESH[2]	THRESH[1]	THRESH[0]	0x04
IN_A/IN_B LOS hysteresis	0x82, 0xA2		HYST[6]	HYST[5]	HYST[4]	HYST[3]	HYST[2]	HYST[1]	HYST[0]	0x12

Table 11. LOS Status Registers

Name	Address	Bit 7	Bit 6	Bit 5	Bit 4	Bit 3	Bit 2	Bit 1	Bit 0
IN_A/IN_B LOS status	0x1F, 0x3F	STICKY LOS[3]	STICKY LOS[2]	STICKY LOS[1]	STICKY LOS[0]	REAL-TIME LOS[3]	REAL-TIME LOS[2]	REAL-TIME LOS[1]	REAL-TIME LOS[0]

ADN8102

LOOPBACK

The ADN8102 provides loopback on both input ports (Port A: cable interface input, and Port B: line card interface input). The external loopback toggle pin, LB, controls the loopback of the Port B input only (board side loopback). When loopback is asserted, valid data continues to pass through the Port B link, but the Port B input signals are also shunted to the Port A output to allow testing and debugging without disrupting valid data. This loopback, as well as loopback of the Port A input (cable side loopback), can be programmed through the I²C interface. The loopbacks are controlled through the I²C interface by writing to Bit 0 and Bit 1 of the loopback control register (Register 0x02).

Bit 0 represents loopback of the Port A inputs to the Port B outputs (cable side loopback). Bit 1 represents loopback of the Port B inputs to the Port A outputs (board side loopback), with high representing loopback for both bits. Bit 1 can be overridden by the LB pin if the pin mode register is set to enable loopback via external pin as shown in Table 5. Both input ports can be looped back simultaneously (full loopback) by writing high to both Bit 0 and Bit 1, but in this case, valid data is disrupted on each channel. Figure 40 illustrates the three loopback modes.

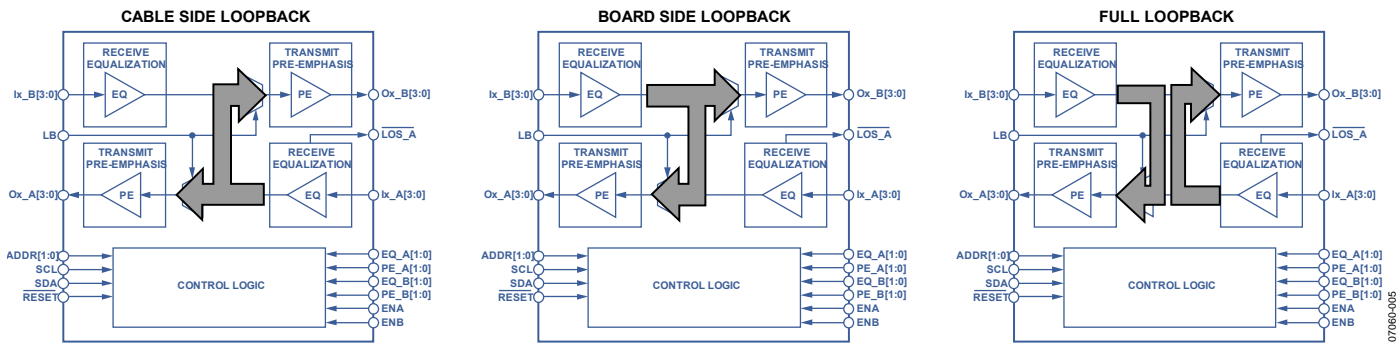

Table 12. Loopback Control Functionality

Control Mode ¹	LB Pin	LB[1]	LB[0]	Description
Pin Control (00 or 01)	0	X ²	X	Loopback disabled
	1	X	X	Board side loopback enabled
Serial Control (10 or 11)	X	0	0	Loopback disabled
	X	0	1	Cable side loopback enabled
	X	1	0	Board side loopback enabled
	X	1	1	Full loopback enabled

¹ Refer to Table 5 for additional information regarding control mode settings.

² X = don't care.

Table 13. Loopback Control Register

Name	Address	Bit 7	Bit 6	Bit 5	Bit 4	Bit 3	Bit 2	Bit 1	Bit 0	Default
Loopback control	0x02							LB[1]	LB[0]	0x00

TRANSMITTERS

Output Structure and Output Levels

The ADN8102 transmitter outputs incorporate 50 Ω termination resistors, ESD protection, and an output current switch. Each port provides control of both the absolute output level and the pre-emphasis output level. It should be noted that the choice of output level affects the output common-mode level. A 600 mV peak-to-peak differential output level with full pre-emphasis range requires an output termination voltage of 2.5 V or greater ($V_{TTO}, V_{CC} \geq 2.5\text{ V}$).

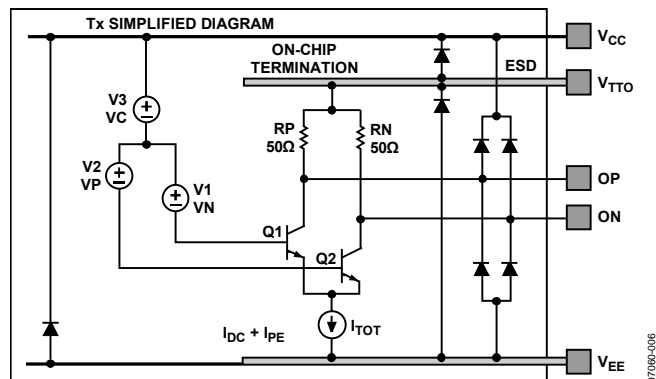

Figure 41. Simplified Output Structure

Pre-Emphasis

The total output amplitude and pre-emphasis setting space is reduced to a single map of basic settings that provide seven settings of output equalization to ease programming for typical channels. The PE_A/PE_B[1:0] pins provide selections 0, 2, 4, and 6 of the seven pre-emphasis settings through toggle pin control, covering the entire range of settings at lower resolution. The full resolution of seven settings is available through the I²C interface by writing to Bits[2:0] (PE[2:0] of the OUT_A/OUT_B configuration registers) with I²C settings overriding the toggle

pin control. Similar to the receiver settings, the ADN8102 allows joint control of all four channels in a transmit port. Table 15 summarizes the absolute output level, pre-emphasis level, and high frequency boost for each of the basic control settings and the typical length of the CX4 cable and FR4 trace that each setting compensates.

Full control of the transmit output levels is available through the I²C control interface. This full control is achieved by writing to the OUT_A/OUT_B Output Level Control[1:0] registers for the channel of interest. Table 17 shows the supported output level settings of the OUT_A/OUT_B Output Level Control[1:0] registers. Register settings not listed in Table 17 are not supported by the ADN8102.

The output equalization is optimized for less than 1.75 Gbps operation but can be optimized for higher speed applications at up to 3.75 Gbps through the I²C control interface by writing to the DATA RATE bit (Bit 4) of the OUT_A/OUT_B configuration registers, with high representing 3.75 Gbps and low representing 1.75 Gbps. The PE CTL SRC bit (Bit 7) in the OUT_A/OUT_B Output Level Control 1 register determines whether the pre-emphasis and output current controls for the channel of interest are selected from the optimized map or directly from the OUT_A/OUT_B Output Level Control[1:0] registers (per channel). Setting this bit high selects pre-emphasis control directly from the OUT_A/OUT_B Output Level Control[1:0] registers, and setting it low selects pre-emphasis control from the optimized map.

Table 14. Data Rate Select

OUT_A/OUT_B Configuration Bit 4	Supported Data Rates
0 (default)	0 Gbps to 1.75 Gbps
1	1.75 Gbps to 3.75 Gbps

Table 15. Transmit Pre-Emphasis Boost and Overshoot vs. Setting

PE[2:0] Register	PE[1:0] Pins	Boost (dB)	Overshoot (%)	DC Swing (mV p-p diff)	Typical CX4 Cable Length (Meters)	Typical FR4 Trace Length (Inches)
0	0	0	0	800	0 to 2.5	0 to 5
1	Not applicable	2	25	800	2.5 to 5	0 to 5
2	1	3.5	50	800	5 to 7.5	10 to 15
3	Not applicable	4.9	75	800	7.5 to 10	10 to 15
4	2	6	100	800	10 to 12.5	15 to 20
5	Not applicable	7.4	133	600	15 to 17.5	20 to 25
6	4	9.5	200	400	20 to 22.5	25 to 30

Table 16. Output Configuration Registers

Name	Address	Bit 7	Bit 6	Bit 5	Bit 4	Bit 3	Bit 2	Bit 1	Bit 0	Default	
OUT_A/OUT_B configuration	0xC0, 0xE0			EN	DATA RATE		PE[2]	PE[1]	PE[0]	0x20	
OUT_A/OUT_B Output Level Control 1	0xC1, 0xE1	PE CTL SRC	OUTx_OLEV1[6:0]								0x40
OUT_A/OUT_B Output Level Control 0	0xC2, 0xE2	OUTx_OLEV0[6:0]								0x40	

ADN8102

Table 17. Output Level Settings

V _{SW-DC} (mV)	V _{SW-PE} (mV)	V _{DPP-DC} (mV)	V _{DPP-PE} (mV)	PE (dB)	I _{TOT} (mA)	OUT_A/OUT_B OLEV 0	OUT_A/OUT_B OLEV 1
50	50	100	100	0.00	2	0x00	0x81
50	150	100	300	9.54	6	0x11	0x81
50	250	100	500	13.98	10	0x22	0x81
50	350	100	700	16.90	14	0x33	0x81
50	450	100	900	19.08	18	0x44	0x81
50	550	100	1100	20.83	22	0x55	0x81
50	650	100	1300	22.28	26	0x66	0x81
100	100	200	200	0.00	4	0x00	0x91
100	200	200	400	6.02	8	0x11	0x91
100	300	200	600	9.54	12	0x22	0x91
100	400	200	800	12.04	16	0x33	0x91
100	500	200	1000	13.98	20	0x44	0x91
100	600	200	1200	15.56	24	0x55	0x91
100	700	200	1400	16.90	28	0x66	0x91
150	150	300	300	0.00	6	0x00	0x92
150	250	300	500	4.44	10	0x11	0x92
150	350	300	700	7.36	14	0x22	0x92
150	450	300	900	9.54	18	0x33	0x92
150	550	300	1100	11.29	22	0x44	0x92
150	650	300	1300	12.74	26	0x55	0x92
150	750	300	1500	13.98	30	0x66	0x92
200	200	400	400	0.00	8	0x00	0xA2
200	300	400	600	3.52	12	0x11	0xA2
200	400	400	800	6.02	16	0x22	0xA2
200	500	400	1000	7.96	20	0x33	0xA2
200	600	400	1200	9.54	24	0x44	0xA2
200	700	400	1400	10.88	28	0x55	0xA2
200	800	400	1600	12.04	32	0x66	0xA2
250	250	500	500	0.00	10	0x00	0xA3
250	350	500	700	2.92	14	0x11	0xA3
250	450	500	900	5.11	18	0x22	0xA3
250	550	500	1100	6.85	22	0x33	0xA3
250	650	500	1300	8.30	26	0x44	0xA3
250	750	500	1500	9.54	30	0x55	0xA3
250	850	500	1700	10.63	34	0x66	0xA3
300	300	600	600	0.00	12	0x00	0xB3
300	400	600	800	2.50	16	0x11	0xB3
300	500	600	1000	4.44	20	0x22	0xB3
300	600	600	1200	6.02	24	0x33	0xB3
300	700	600	1400	7.36	28	0x44	0xB3
300	800	600	1600	8.52	32	0x55	0xB3
300	900	600	1800	9.54	36	0x66	0xB3
350	350	700	700	0.00	14	0x00	0xB4
350	450	700	900	2.18	18	0x11	0xB4
350	550	700	1100	3.93	22	0x22	0xB4
350	650	700	1300	5.38	26	0x33	0xB4
350	750	700	1400	6.62	30	0x44	0xB4
350	850	700	1700	7.71	34	0x55	0xB4
350	950	700	1900	8.67	38	0x66	0xB4
400	400	800	800	0.00	16	0x00	0xC4
400	500	800	1000	1.94	20	0x11	0xC4
400	600	800	1200	3.52	24	0x22	0xC4
400	700	800	1400	4.86	28	0x33	0xC4
400	800	800	1600	6.02	32	0x44	0xC4
400	900	800	1800	7.04	36	0x55	0xC4
400	1000	800	2000	7.96	40	0x66	0xC4

V _{SW-DC} (mV)	V _{SW-PE} (mV)	V _{DPP-DC} (mV)	V _{DPP-PE} (mV)	PE (dB)	I _{TOT} (mA)	OUT_A/OUT_B OLEV 0	OUT_A/OUT_B OLEV 1
450	450	900	900	0.00	18	0x00	0xC5
450	550	900	1100	1.74	22	0x11	0xC5
450	650	900	1300	3.19	26	0x22	0xC5
450	750	900	1500	4.44	30	0x33	0xC5
450	850	900	1700	5.52	34	0x44	0xC5
450	950	900	1900	6.49	38	0x55	0xC5
450	1050	900	2100	7.36	42	0x66	0xC5
500	500	1000	1000	0.00	20	0x00	0xD5
500	600	1000	1200	1.58	24	0x11	0xD5
500	700	1000	1400	2.92	28	0x22	0xD5
500	800	1000	1600	4.08	32	0x33	0xD5
500	900	1000	1800	5.11	36	0x44	0xD5
500	1000	1000	2000	6.02	40	0x55	0xD5
500	1100	1000	2200	6.85	44	0x66	0xD5
550	550	1100	1100	0.00	22	0x00	0xD6
550	650	1100	1300	1.45	26	0x11	0xD6
550	750	1100	1500	2.69	30	0x22	0xD6
550	850	1100	1700	3.78	34	0x33	0xD6
550	950	1100	1900	4.75	38	0x44	0xD6
550	1050	1100	2100	5.62	42	0x55	0xD6
550	1150	1100	2300	6.41	46	0x66	0xD6
600	600	1200	1200	0.00	24	0x00	0xE6
600	700	1200	1400	1.34	28	0x11	0xE6
600	800	1200	1600	2.50	32	0x22	0xE6
600	900	1200	1800	3.52	36	0x33	0xE6
600	1000	1200	2000	4.44	40	0x44	0xE6
600	1100	1200	2200	5.26	44	0x55	0xE6
600	1200	1200	2400	6.02	48	0x66	0xE6
650	650	1300	1300	0.00	26	0x01	0xE6
650	750	1300	1500	1.24	30	0x12	0xE6
650	850	1300	1700	2.33	34	0x23	0xE6
650	950	1300	1900	3.30	38	0x34	0xE6
650	1050	1300	2100	4.17	42	0x45	0xE6
650	1150	1300	2300	4.96	46	0x56	0xE6
700	700	1400	1400	0.00	28	0x02	0xE6
700	800	1400	1600	1.16	32	0x13	0xE6
700	900	1400	1800	2.18	36	0x24	0xE6
700	1000	1400	2000	3.10	40	0x35	0xE6
700	1100	1400	2300	3.93	44	0x46	0xE6
750	750	1500	1500	0.00	30	0x03	0xE6
750	850	1500	1700	1.09	34	0x14	0xE6
750	950	1500	1900	2.05	38	0x25	0xE6
750	1050	1500	2100	2.92	42	0x36	0xE6
800	800	1600	1600	0.00	32	0x04	0xE6
800	900	1600	1800	1.02	36	0x15	0xE6
800	1000	1600	2000	1.94	40	0x26	0xE6
850	850	1700	1700	0.00	34	0x05	0xE6
850	950	1700	1900	0.97	38	0x16	0xE6
900	900	1800	1800	0.00	36	0x06	0xE6

SELECTIVE SQUELCH AND DISABLE

Each transmitter is equipped with output disable and output squelch controls. Disable is a full power-down state: the transmitter current is reduced to zero, and the output pins pull up to V_{TTO} , but there is a delay of approximately 1 μ s associated with re-enabling the transmitter. The output disable control is accessed through the EN bit (Bit 4) of the OUT_A/OUT_B configuration registers through the I²C control interface.

Squelch is not a full power-down state but a state in which only the output current is reduced to zero and the output pins pull up to V_{TTO} , and there is a much smaller delay to bring back the output current. The output squelch and the output disable control can both be accessed through the OUT_A/OUT_B squelch control registers, with the top nibble representing the squelch control for one entire output port, and the bottom nibble representing the output disable for one entire output port. The ports are disabled or squelched by writing 0s to the corresponding nibbles. The ports are enabled by writing all 1s, which is the

default setting. For example, to squelch Port A, Register 0xC3 must be set to 0x0F. The entire nibble must be written to all 0s for this functionality.

Table 18. Squelch and Disable Control Registers

Name	Address	Data		Default
OUT_A/ OUT_B squelch control	0xC3, 0xE3	SQUELCH[3:0]	DISABLE[3:0]	0xFF

Table 19. Squelch and Disable Functionality

SQUELCH[3:0]	DISABLE[3:0]	Output State
1111	1111	Enabled (default)
xxxx ¹	0000	Disabled
0000	1111	Squelched

¹ xxxx = don't care

I²C CONTROL INTERFACE

SERIAL INTERFACE GENERAL FUNCTIONALITY

The ADN8102 register set is controlled through a 2-wire I²C interface. The ADN8102 acts only as an I²C slave device. Therefore, the I²C bus in the system needs to include an I²C master to configure the ADN8102 and other I²C devices that may be on the bus. Data transfers are controlled using the two I²C wires: the SCL input clock pin and the SDA bidirectional data pin.

The ADN8102 I²C interface can be run in the standard (100 kHz) and fast (400 kHz) modes. The SDA line only changes value when the SCL pin is low with two exceptions. To indicate the beginning or continuation of a transfer, the SDA pin is driven low while the SCL pin is high, and to indicate the end of a transfer, the SDA line is driven high while the SCL line is high. Therefore, it is important to control the SCL clock to toggle only when the SDA line is stable, unless indicating a start, repeated start, or stop condition.

I²C INTERFACE DATA TRANSFERS—DATA WRITE

To write data to the ADN8102 register set, a microcontroller, or any other I²C master, needs to send the appropriate control signals to the ADN8102 slave device. The steps that need to be completed are listed as follows, where the signals are controlled by the I²C master, unless otherwise specified. A diagram of the procedure can be seen in Figure 42.

1. Send a start condition (while holding the SCL line high, pull the SDA line low).
2. Send the ADN8102 part address (seven bits) whose upper five bits are the static value 10010b and whose lower two bits are controlled by the ADDR[1:0] input pins. This transfer should be MSB first.
3. Send the write indicator bit (0).
4. Wait for the ADN8102 to acknowledge the request.
5. Send the register address (eight bits) to which data is to be written. This transfer should be MSB first.
6. Wait for the ADN8102 to acknowledge the request.

7. Send the data (eight bits) to be written to the register whose address was set in Step 5. This transfer should be MSB first.
8. Wait for the ADN8102 to acknowledge the request.
- 9a. Send a stop condition (while holding the SCL line high, pull the SDA line high) and release control of the bus.
- 9b. Send a repeated start condition (while holding the SCL line high, pull the SDA line low) and continue with Step 2 in this procedure to perform another write.
- 9c. Send a repeated start condition (while holding the SCL line high, pull the SDA line low) and continue with Step 2 of the read procedure (in the I²C Interface Data Transfers—Data Read section) to perform a read from another address.
- 9d. Send a repeated start condition (while holding the SCL line high, pull the SDA line low) and continue with Step 8 of the read procedure (in the I²C Interface Data Transfers—Data Read section) to perform a read from the same address set in Step 5.

Figure 42 shows the ADN8102 write process. The SCL signal is shown along with a general write operation and a specific example. In the example, Data 0x92 is written to Address 0x6D of an ADN8102 part with a part address of 0x4B. The part address is seven bits wide. The upper five bits of the ADN8102 are internally set to 10010b. The lower two bits are controlled by the ADDR[1:0] pins. In this example, the bits controlled by the ADDR[1:0] pins are set to 11b. In Figure 42, the corresponding step number is visible in the circle under the waveform. The SCL line is driven by the I²C master and never by the ADN8102 slave. As for the SDA line, the data in the shaded polygons is driven by the ADN8102, whereas the data in the nonshaded polygons is driven by the I²C master. The end phase case shown is that of Step 9a.

Note that the SDA line only changes when the SCL line is low, except for the case of sending a start, stop, or repeated start condition, Step 1 and Step 9 in this case.

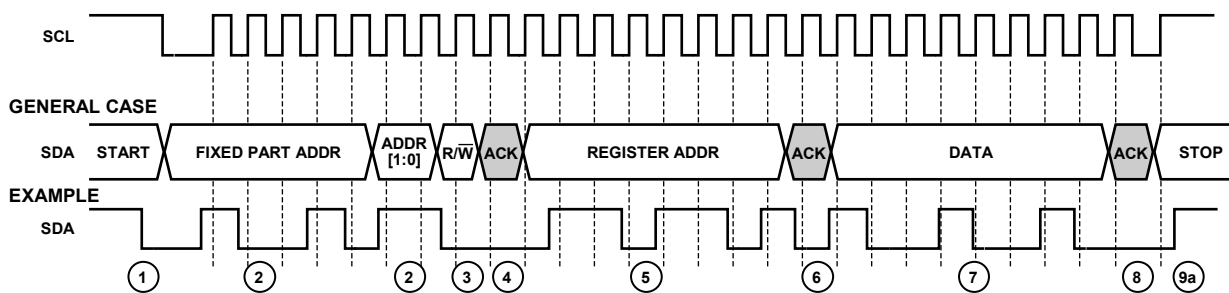

Figure 42. I²C Write Diagram

07060-008

ADN8102

I²C INTERFACE DATA TRANSFERS—DATA READ

To read data from the ADN8102 register set, a microcontroller, or any other I²C master, needs to send the appropriate control signals to the ADN8102 slave device. The steps that need to be completed are listed as follows, where the signals are controlled by the I²C master, unless otherwise specified. A diagram of the procedure can be seen in Figure 43.

1. Send a start condition (while holding the SCL line high, pull the SDA line low).
2. Send the ADN8102 part address (seven bits) whose upper five bits are the static value 10010b and whose lower two bits are controlled by the input pins ADDR[1:0]. This transfer should be MSB first.
3. Send the write indicator bit (0).
4. Wait for the ADN8102 to acknowledge the request.
5. Send the register address (eight bits) from which data is to be read. This transfer should be MSB first. The register address is kept in memory in the ADN8102 until the part is reset or the register address is written over with the same procedure (Step 1 to Step 6).
6. Wait for the ADN8102 to acknowledge the request.
7. Send a repeated start condition (while holding the SCL line high, pull the SDA line low).
8. Send the ADN8102 part address (seven bits) whose upper five bits are the static value 10010b and whose lower two bits are controlled by the input pins ADDR[1:0]. This transfer should be MSB first.
9. Send the read indicator bit (1).
10. Wait for the ADN8102 to acknowledge the request.
11. The ADN8102 then serially transfers the data (eight bits) held in the register indicated by the address set in Step 5.
12. Acknowledge the data.

- 13a. Send a stop condition (while holding the SCL line high, pull the SDA line high) and release control of the bus.
- 13b. Send a repeated start condition (while holding the SCL line high, pull the SDA line low) and continue with Step 2 of the write procedure (in the I²C Interface Data Transfers—Data Write section) to perform a write.
- 13c. Send a repeated start condition (while holding the SCL line high, pull the SDA line low) and continue with Step 2 of this procedure to perform a read from a another address.
- 13d. Send a repeated start condition (while holding the SCL line high, pull the SDA line low) and continue with Step 8 of this procedure to perform a read from the same address.

Figure 43 shows the ADN8102 read process. The SCL signal is shown along with a general read operation and a specific example. In the example, Data 0x49 is read from Address 0x6D of an ADN8102 part with a part address of 0x4B. The part address is seven bits wide. The upper five bits of the ADN8102 are internally set to 10010b. The lower two bits are controlled by the ADDR[1:0] pins. In this example, the bits controlled by the ADDR[1:0] pins are set to 11b. In Figure 43, the corresponding step number is visible in the circle under the waveform. The SCL line is driven by the I²C master and never by the ADN8102 slave. As for the SDA line, the data in the shaded polygons is driven by the ADN8102, whereas the data in the nonshaded polygons is driven by the I²C master. The end phase case shown is that of Step 13a.

Note that the SDA line changes only when the SCL line is low, except for the case of sending a start, stop, or repeated start condition, as in Step 1, Step 7, and Step 13. In Figure 43, A is the same as ACK in Figure 42. Equally, Sr represents a repeated start where the SDA line is brought high before SCL is raised. SDA is then dropped while SCL is still high.

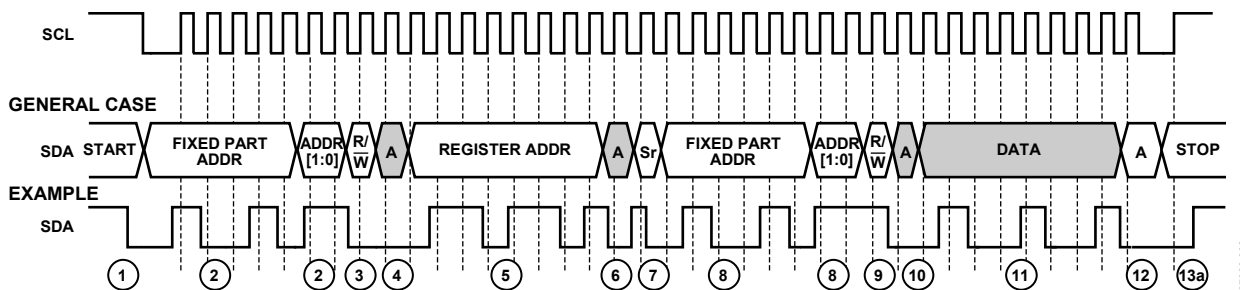

Figure 43. I²C Read Diagram

APPLICATIONS INFORMATION

OUTPUT COMPLIANCE

In low voltage applications, users must pay careful attention to both the differential and common-mode signal levels. The choice of output voltage swing, preemphasis setting, supply voltages (V_{CC} and V_{TTO}), and output coupling (ac or dc) affect peak and settled single-ended voltage swings and the common-mode shift measured across the output termination resistors. These choices also affect output current and, consequently, power consumption. For ac-coupled applications, certain combinations of supply voltage, output voltage swing, and preemphasis settings may violate the single-ended absolute output low voltage, as specified in Table 1. Under these conditions, the performance is degraded; therefore, these settings are not recommended. Table 21 includes annotations that identify these settings. In dc-coupled applications, the far-end termination voltage should be equal to V_{TTO} to allow the full list of output swing and preemphasis settings listed in Table 17.

TxHeadroom

The TxHeadroom register (Register 0x23) allows configuration of the individual transmitters for extra headroom at the output for high current applications. The bits in this register are active high (default) and are one per output (see Table 22). Setting a bit high puts the respective transmitter in a configuration for extra headroom, and setting a bit low does not provide extra headroom. The TxHeadroom bits should only be set high when required for a given output swing as listed in Table 21. Note that TxHeadroom is not available for $V_{CC} < 2.5$ V.

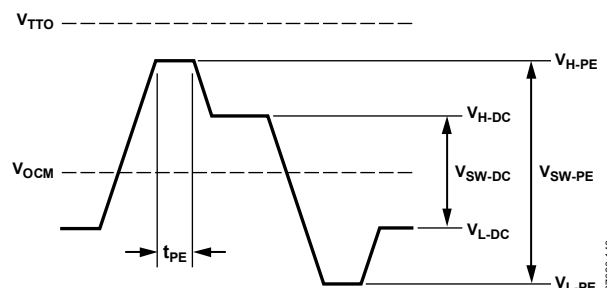

Figure 44. Simplified Output Voltage Levels Diagram

Table 20. Symbol Definitions

Symbol	Formula	Definition
I_{DC}	Programmable	Output current that sets output level
I_{PE}	Programmable	Output current for PE delayed tap
I_{TTO}	$I_{DC} + I_{PE}$	Total transmitter output current
V_{DPP-DC}	$25 \Omega \times I_{DC} \times 2$	Peak-to-peak differential voltage swing of nonpreemphasized waveform
V_{DPP-PE}	$25 \Omega \times I_{TTO} \times 2$	Peak-to-peak differential voltage swing of preemphasized waveform
V_{SW-DC}	$V_{DPP-DC}/2 = V_{H-DC} - V_{L-DC}$	DC single-ended voltage swing
V_{SW-PE}	$V_{DPP-PE}/2 = V_{H-PE} - V_{L-PE}$	Preemphasized single-ended voltage swing
$\Delta V_{OCM_DC-COUPLED}$	$25 \Omega \times I_{TTO}/2$	Output common-mode shift, dc-coupled outputs
$\Delta V_{OCM_AC-COUPLED}$	$50 \Omega \times I_{TTO}/2$	Output common-mode shift, ac-coupled outputs
V_{OCM}	$V_{TTO} - \Delta V_{OCM} = (V_{H-DC} + V_{L-DC})/2$	Output common-mode voltage
V_{H-DC}	$V_{TTO} - \Delta V_{OCM} + V_{DPP-DC}/2$	DC single-ended output high voltage
V_{L-DC}	$V_{TTO} - \Delta V_{OCM} - V_{DPP-DC}/2$	DC single-ended output low voltage
V_{H-PE}	$V_{TTO} - \Delta V_{OCM} + V_{DPP-PE}/2$	Maximum single-ended output voltage
V_{L-PE}	$V_{TTO} - \Delta V_{OCM} - V_{DPP-PE}/2$	Minimum single-ended output voltage

ADN8102

Table 21. Output Compliance for AC-Coupled Outputs

V _{SW-DC} (mV)	V _{SW-PE} (mV)	PE (dB)	I _{TOT} (mA)	OLEV 0	OLEV1	V _{CC} =V _{TTO} =3.3V	V _{CC} =V _{TTO} =2.5V	V _{CC} =V _{TTO} =1.8V
200	200	0.00	8	0x00	0xA2	Supported	Supported	Supported
200	300	3.52	12	0x11	0xA2	Supported	Supported	Supported
200	400	6.02	16	0x22	0xA2	Supported	Supported	Supported
200	500	7.96	20	0x33	0xA2	Supported	Supported	Supported
200	600	9.54	24	0x44	0xA2	Supported	Supported	Supported
200	700	10.88	28	0x55	0xA2	Supported	Supported	Not Supported
200	800	12.04	32	0x66	0xA2	Use TX_HDRM = 1	Use TX_HDRM = 1	Not Supported
300	300	0.00	12	0x00	0xB3	Supported	Supported	Supported
300	400	2.50	16	0x11	0xB3	Supported	Supported	Supported
300	500	4.44	20	0x22	0xB3	Supported	Supported	Supported
300	600	6.02	24	0x33	0xB3	Supported	Supported	Supported
300	700	7.36	28	0x44	0xB3	Supported	Supported	Supported
300	800	8.52	32	0x55	0xB3	Use TX_HDRM = 1	Use TX_HDRM = 1	Not Supported
300	900	9.54	36	0x66	0xB3	Not Supported	Not Supported	Not Supported
400	400	0.00	16	0x00	0xC4	Supported	Supported	Supported
400	500	1.94	20	0x11	0xC4	Supported	Supported	Supported
400	600	3.52	24	0x22	0xC4	Supported	Supported	Supported
400	700	4.86	28	0x33	0xC4	Supported	Supported	Supported
400	800	6.02	32	0x44	0xC4	Use TX_HDRM = 1	Use TX_HDRM = 1	Not Supported
400	900	7.04	36	0x55	0xC4	Not Supported	Not Supported	Not Supported
400	1000	7.96	40	0x66	0xC4	Not Supported	Not Supported	Not Supported
600	600	0.00	24	0x00	0xE6	Supported	Supported	Supported
600	700	1.34	28	0x11	0xE6	Supported	Supported	Supported
600	800	2.50	32	0x22	0xE6	Use TX_HDRM = 1	Use TX_HDRM = 1	Not Supported
600	900	3.52	36	0x33	0xE6	Not Supported	Not Supported	Not Supported
600	1000	4.44	40	0x44	0xE6	Not Supported	Not Supported	Not Supported
600	1100	5.26	44	0x55	0xE6	Not Supported	Not Supported	Not Supported
600	1200	6.02	48	0x66	0xE6	Not Supported	Not Supported	Not Supported

PRINTED CIRCUIT BOARD (PCB) LAYOUT GUIDELINES

The high speed differential inputs and outputs should be routed with $100\ \Omega$ controlled impedance, differential transmission lines. The transmission lines, either microstrip or stripline, should be referenced to a solid low impedance reference plane. An example of a PCB cross-section is shown in Figure 45. The trace width (W), differential spacing (S), height above reference plane (H), and dielectric constant of the PCB material determine the characteristic impedance. Adjacent channels should be kept apart by a distance greater than $3W$ to minimize crosstalk.

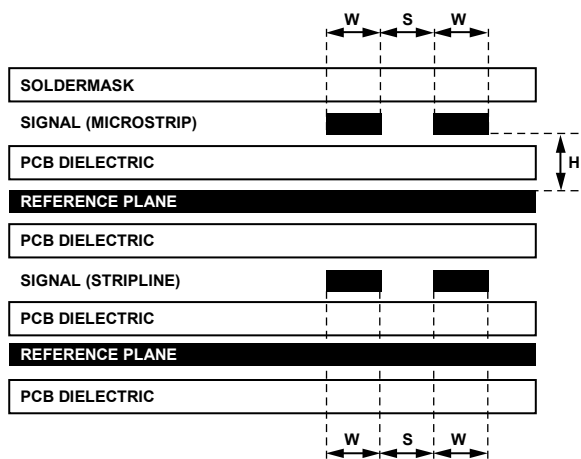

Figure 45. Example of a PCB Cross-Section

Power Supply Connections and Ground Planes

Use of one low impedance ground plane is recommended. The VEE pins should be soldered directly to the ground plane to reduce series inductance. If the ground plane is an internal plane and connections to the ground plane are made through vias, multiple vias can be used in parallel to reduce the series inductance. The exposed pad should be connected to the VEE plane using plugged vias so that solder does not leak through the vias during reflow.

Use of a $10\ \mu\text{F}$ electrolytic capacitor between VCC and VEE is recommended at the location where the $3.3\ \text{V}$ supply enters the printed circuit board (PCB). It is recommended that $0.1\ \mu\text{F}$ and $1\ \text{nF}$ ceramic chip capacitors be placed in parallel at each supply pin for high frequency, power supply decoupling. When using $0.1\ \mu\text{F}$ and $1\ \text{nF}$ ceramic chip capacitors, they should be placed between the IC power supply pins (VCC, VTTI, and VTTO) and VEE, as close as possible to the supply pins.

By using adjacent power supply and GND planes, excellent high frequency decoupling can be realized by using close spacing between the planes. This capacitance is given by

$$C_{\text{PLANE}} = 0.88\epsilon_r \times A/d \text{ (pF)}$$

where:

ϵ_r is the dielectric constant of the PCB material.

A is the area of the overlap of power and GND planes (cm^2).

d is the separation between planes (mm).

For FR4, $\epsilon_r = 4.4$ and $0.25\ \text{mm}$ spacing, $C \approx 15\ \text{pF}/\text{cm}^2$.

Supply Sequencing

Ideally, all power supplies should be brought up to the appropriate levels simultaneously (power supply requirements are set by the supply limits in Table 1 and the absolute maximum ratings listed in Table 3). In the event that the power supplies to the ADN8102 are brought up separately, the supply power-up sequence is as follows: DV_{CC} is powered first, followed by V_{CC} , and lastly V_{TTI} and V_{TTO} . The power-down sequence is reversed, with V_{TTI} and V_{TTO} being powered off first.

V_{TTI} and V_{TTO} contain ESD protection diodes to the V_{CC} power domain (see Figure 39 and Figure 41). To avoid a sustained high current condition in these devices ($I_{\text{SUSTAINED}} < 64\ \text{mA}$), the V_{TTI} and V_{TTO} supplies should be powered on after V_{CC} and should be powered off before V_{CC} .

If the system power supplies have a high impedance in the powered off state, then supply sequencing is not required provided the following limits are observed:

- Peak current from V_{TTI} or V_{TTO} to $V_{\text{CC}} < 200\ \text{mA}$.
- Sustained current from V_{TTI} or V_{TTO} to $V_{\text{CC}} < 64\ \text{mA}$.

Thermal Paddle Design

The LFCSP is designed with an exposed thermal paddle to conduct heat away from the package and into the PCB. By incorporating thermal vias into the PCB thermal paddle, heat is dissipated more effectively into the inner metal layers of the PCB. To ensure device performance at elevated temperatures, it is important to have a sufficient number of thermal vias incorporated into the design. An insufficient number of thermal vias results in a θ_{JA} value larger than specified in Table 1. Additional PCB footprint and assembly guidelines are described in the AN-772 Application Note, *A Design and Manufacturing Guide for the Lead Frame Chip Scale Package (LFCSP)*.

It is recommended that a via array of 4×4 or 5×5 with a diameter of $0.3\ \text{mm}$ to $0.33\ \text{mm}$ be used to set a pitch between $1.0\ \text{mm}$ and $1.2\ \text{mm}$. A representative of these arrays is shown in Figure 46.

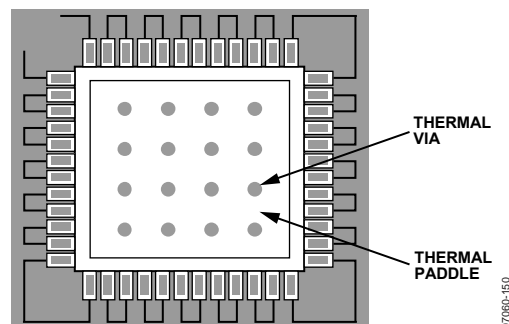

Figure 46. PCB Thermal Paddle and Via

Stencil Design for the Thermal Paddle

To effectively remove heat from the package and to enhance electrical performance, the thermal paddle must be soldered (bonded) to the PCB thermal paddle, preferably with minimum voids. However, eliminating voids may not be possible because of the presence of thermal vias and the large size of the thermal paddle for larger size packages. Also, outgassing during the reflow process may cause defects (splatter, solder balling) if the solder paste coverage is too big. It is recommended that smaller multiple openings in the stencil be used instead of one big opening for printing solder paste on the thermal paddle region. This typically results in 50% to 80% solder paste coverage. Figure 47 shows how to achieve these levels of coverage.

Voids within solder joints under the exposed paddle can have an adverse affect on high speed and RF applications, as well as on thermal performance. Because the LFCSP package incorporates a large center paddle, controlling solder voiding within this region can be difficult. Voids within this ground plane can increase the current path of the circuit. The maximum size for a void should be less than via pitch within the plane. This assures that any one via is not rendered ineffectual when any void increases the current path beyond the distance to the next available via.

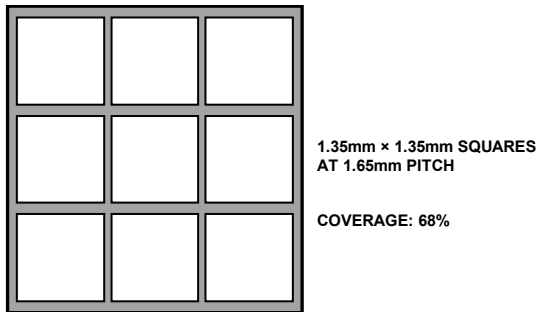

Figure 47. Typical Thermal Paddle Stencil Design

Large voids in the thermal paddle area should be avoided. To control voids in the thermal paddle area, solder masking may be required for thermal vias to prevent solder wicking inside the via during reflow, thus displacing the solder away from the interface between the package thermal paddle and thermal paddle land on the PCB. There are several methods employed for this purpose, such as via tenting (top or bottom side), using dry film solder mask; via plugging with liquid photo-imageable (LPI) solder mask from the bottom side; or via encroaching. These options are depicted in Figure 48. In case of via tenting, the solder mask diameter should be 100 microns larger than the via diameter.

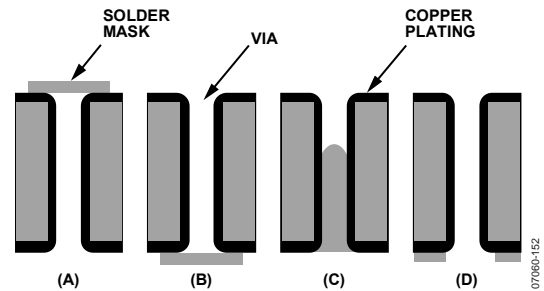

Figure 48. Solder Mask Options for Thermal Vias: (a) Via Tenting from the Top; (b) Via Tenting from the Bottom; (c) Via Plugging, Bottom; and (d) Via Encroaching, Bottom

A stencil thickness of 0.125 mm is recommended for 0.4 mm and 0.5 mm pitch parts. The stencil thickness can be increased to 0.15 mm to 0.2 mm for coarser pitch parts. A laser-cut, stainless steel stencil is recommended with electropolished trapezoidal walls to improve the paste release. Because not enough space is available underneath the part after reflow, it is recommended that no clean Type 3 paste be used for mounting the LFCSP. Inert atmosphere is also recommended during reflow.

REGISTER MAP

Table 22. I²C Register Definitions

Name	Address	Bit 7	Bit 6	Bit 5	Bit 4	Bit 3	Bit 2	Bit 1	Bit 0	Default
Reset	0x00								RESET	
Loopback control	0x02							LB[1]	LB[0]	0x00
Control interface mode	0x0F							MODE[1]	MODE[0]	0x00
TxHeadroom	0x23	TxH_B3	TxH_B2	TxH_B1	TxH_B0	TxH_A3	TxH_A2	TxH_A1	TxH_A0	0x00
IN_A configuration	0x80		PNSWAP	EQBY	EN		EQ[2]	EQ[1]	EQ[0]	0x30
IN_A LOS threshold	0x81		THRESH[6]	THRESH[5]	THRESH[4]	THRESH[3]	THRESH[2]	THRESH[1]	THRESH[0]	0x04
IN_A LOS hysteresis	0x82		HYST[6]	HYST[5]	HYST[4]	HYST[3]	HYST[2]	HYST[1]	HYST[0]	0x12
IN_A LOS status ¹	0x1F	STICKY LOS[3]	STICKY LOS[2]	STICKY LOS[1]	STICKY LOS[0]	REAL-TIME LOS[3]	REAL-TIME LOS[2]	REAL-TIME LOS[1]	REAL-TIME LOS[0]	
IN_A EQ1 control	0x83		EQ CTL SRC	EQ1[5]	EQ1[4]	EQ1[3]	EQ1[2]	EQ1[1]	EQ1[0]	0x00
IN_A EQ2 control	0x84			EQ2[5]	EQ2[4]	EQ2[3]	EQ2[2]	EQ2[1]	EQ2[0]	0x00
IN_A0 FR4 control	0x85							LUT SELECT	LUT FR4/CX4	0x00
IN_A1 FR4 control	0x8D							LUT SELECT	LUT FR4/CX4	0x00
IN_A2 FR4 control	0x95							LUT SELECT	LUT FR4/CX4	0x00
IN_A3 FR4 control	0x9D							LUT SELECT	LUT FR4/CX4	0x00
IN_B configuration	0xA0		PNSWAP	EQBY	EN		EQ[2]	EQ[1]	EQ[0]	0x30
IN_B LOS threshold	0xA1		THRESH[6]	THRESH[5]	THRESH[4]	THRESH[3]	THRESH[2]	THRESH[1]	THRESH[0]	0x04
IN_B LOS hysteresis	0xA2		HYST[6]	HYST[5]	HYST[4]	HYST[3]	HYST[2]	HYST[1]	HYST[0]	0x12
IN_B LOS Status ¹	0x3F	STICKY LOS[3]	STICKY LOS[2]	STICKY LOS[1]	STICKY LOS[0]	REAL-TIME LOS[3]	REAL-TIME LOS[2]	REAL-TIME LOS[1]	REAL-TIME LOS[0]	
IN_B EQ1 control	0xA3		EQ CTL SRC	EQ1[5]	EQ1[4]	EQ1[3]	EQ1[2]	EQ1[1]	EQ1[0]	0x00
IN_B EQ2 control	0xA4			EQ2[5]	EQ2[4]	EQ2[3]	EQ2[2]	EQ2[1]	EQ2[0]	0x00
IN_B3 FR4 control	0xA5							LUT SELECT	LUT FR4/CX4	0x00
IN_B2 FR4 Control	0xAD							LUT SELECT	LUT FR4/CX4	0x00
IN_B1 FR4 control	0xB5							LUT SELECT	LUT FR4/CX4	0x00
IN_B0 FR4 control	0xBD							LUT SELECT	LUT FR4/CX4	0x00

ADN8102

Name	Address	Bit 7	Bit 6	Bit 5	Bit 4	Bit 3	Bit 2	Bit 1	Bit 0	Default
OUT_A configuration	0xC0			EN	DATA RATE		PE[2]	PE[1]	PE[0]	0x20
OUT_A Output Level Control 1	0xC1	PE CTL SRC	OUTA_OLEV1[6:0]							0x40
OUT_A Output Level Control 0	0xC2		OUTA_OLEV0[6:0]							0x40
OUT_A squelch control	0xC3	SQUELCH[3:0]				DISABLE[3:0]				0xFF
OUT_B configuration	0xE0			EN	DATA RATE		PE[2]	PE[1]	PE[0]	0x20
OUT_B Output Level Control 1	0xE1	PE CTL SRC	OUTB_OLEV1[6:0]							0x40
OUT_B Output Level Control 0	0xE2		OUTB_OLEV0[6:0]							0x40
OUT_B squelch control	0xE3	SQUELCH[3:0]				DISABLE[3:0]				0xFF

¹ Read-only register.

OUTLINE DIMENSIONS

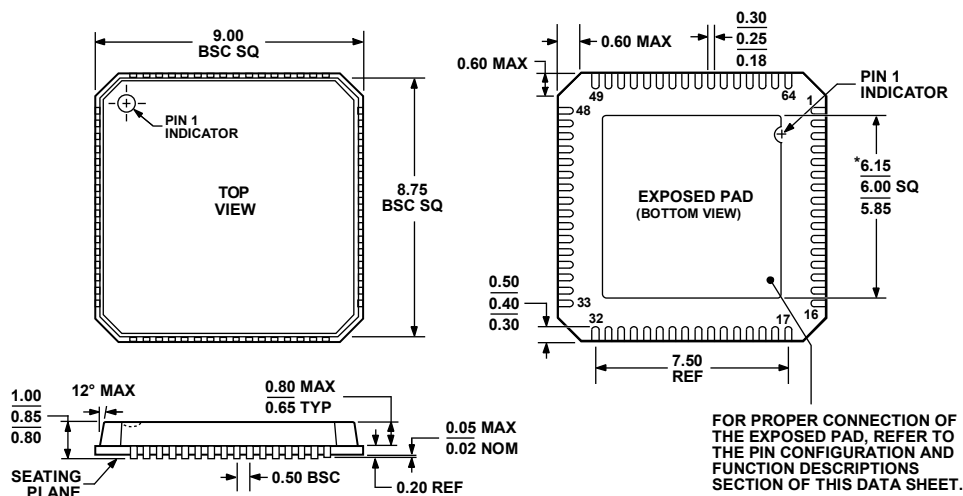

*COMPLIANT TO JEDEC STANDARDS MO-220-VMM4-4 EXCEPT FOR EXPOSED PAD DIMENSION

Figure 49. 64-Lead Lead Frame Chip Scale Package [LFCSP_VQ]
 9 mm × 9 mm Body, Very Thin Quad
 (CP-64-2)
 Dimensions shown in millimeters

08P108-B

ORDERING GUIDE

Model ¹	Temperature Range	Package Description	Package Option
ADN8102ACPZ	-40°C to +85°C	64-Lead Lead Frame Chip Scale Package [LFCSP_VQ]	CP-64-2
ADN8102ACPZ-R7	-40°C to +85°C	64-Lead Lead Frame Chip Scale Package [LFCSP_VQ]	CP-64-2
ADN8102-EVALZ		Evaluation Board	

¹ Z = RoHS Compliant Part.

ADN8102

NOTES

NOTES

NOTES

I²C refers to a communications protocol originally developed by Philips Semiconductors (now NXP Semiconductors).

Компания «Океан Электроники» предлагает заключение долгосрочных отношений при поставках импортных электронных компонентов на взаимовыгодных условиях!

Наши преимущества:

- Поставка оригинальных импортных электронных компонентов напрямую с производств Америки, Европы и Азии, а так же с крупнейших складов мира;
- Широкая линейка поставок активных и пассивных импортных электронных компонентов (более 30 млн. наименований);
- Поставка сложных, дефицитных, либо снятых с производства позиций;
- Оперативные сроки поставки под заказ (от 5 рабочих дней);
- Экспресс доставка в любую точку России;
- Помощь Конструкторского Отдела и консультации квалифицированных инженеров;
- Техническая поддержка проекта, помощь в подборе аналогов, поставка прототипов;
- Поставка электронных компонентов под контролем ВП;
- Система менеджмента качества сертифицирована по Международному стандарту ISO 9001;
- При необходимости вся продукция военного и аэрокосмического назначения проходит испытания и сертификацию в лаборатории (по согласованию с заказчиком);
- Поставка специализированных компонентов военного и аэрокосмического уровня качества (Xilinx, Altera, Analog Devices, Intersil, Interpoint, Microsemi, Actel, Aeroflex, Peregrine, VPT, Syfer, Eurofarad, Texas Instruments, MS Kennedy, Miteq, Cobham, E2V, MA-COM, Hittite, Mini-Circuits, General Dynamics и др.);

Компания «Океан Электроники» является официальным дистрибьютором и эксклюзивным представителем в России одного из крупнейших производителей разъемов военного и аэрокосмического назначения «**JONHON**», а так же официальным дистрибьютором и эксклюзивным представителем в России производителя высокотехнологичных и надежных решений для передачи СВЧ сигналов «**FORSTAR**».



JONHON

«**JONHON**» (основан в 1970 г.)

Разъемы специального, военного и аэрокосмического назначения:

(Применяются в военной, авиационной, аэрокосмической, морской, железнодорожной, горно- и нефтедобывающей отраслях промышленности)

«**FORSTAR**» (основан в 1998 г.)

ВЧ соединители, коаксиальные кабели,
кабельные сборки и микроволновые компоненты:

(Применяются в телекоммуникациях гражданского и специального назначения, в средствах связи, РЛС, а так же военной, авиационной и аэрокосмической отраслях промышленности).



Телефон: 8 (812) 309-75-97 (многоканальный)

Факс: 8 (812) 320-03-32

Электронная почта: ocean@oceanchips.ru

Web: <http://oceanchips.ru/>

Адрес: 198099, г. Санкт-Петербург, ул. Калинина, д. 2, корп. 4, лит. А