

# MBR140ESF, NRVB140ESF

## Surface Mount Schottky Power Rectifier

### Plastic SOD-123 Package

This device uses the Schottky Barrier principle with a large area metal-to-silicon power diode. Ideally suited for low voltage, high frequency rectification or as free wheeling and polarity protection diodes in surface mount applications where compact size and weight are critical to the system. This package also provides an easy to work with alternative to leadless 34 package style. Because of its small size, it is ideal for use in portable and battery powered products such as cellular and cordless phones, chargers, notebook computers, printers, PDAs and PCMCIA cards. Typical applications are AC-DC and DC-DC converters, reverse battery protection, and “Oring” of multiple supply voltages and any other application where performance and size are critical.

#### Features

- Guardring for Stress Protection
- Low Reverse Leakage
- 175°C Operating Junction Temperature
- Epoxy Meets UL 94 V-0 @ 0.125 in
- Package Designed for Optimal Automated Board Assembly
- ESD Rating:
  - ◆ Human Body Model = 3B
  - ◆ Machine Model = M4
- NRVB Prefix for Automotive and Other Applications Requiring Unique Site and Control Change Requirements; AEC-Q101 Qualified and PPAP Capable
- These Devices are Pb-Free and are RoHS Compliant\*

#### Mechanical Characteristics

- Device Marking: E4F
- Polarity Designator: Cathode Band
- Weight: 11.7 mg (approximately)
- Case: Epoxy, Molded
- Finish: All External Surfaces Corrosion Resistant and Terminal Leads are Readily Solderable
- Lead and Mounting Surface Temperature for Soldering Purposes: 260°C Max. for 10 Seconds

\*For additional information on our Pb-Free strategy and soldering details, please download the ON Semiconductor Soldering and Mounting Techniques Reference Manual, SOLDERRM/D.



ON Semiconductor®

<http://onsemi.com>

**SCHOTTKY BARRIER  
RECTIFIER  
1.0 AMPERES  
40 VOLTS**

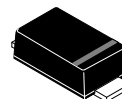

SOD-123FL  
CASE 498

#### MARKING DIAGRAM

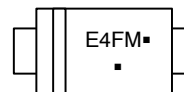

E4F = Specific Device Code  
M = Date Code  
▪ = Pb-Free Package

(Note: Microdot may be in either location)

#### ORDERING INFORMATION

| Device        | Package                | Shipping†                   |
|---------------|------------------------|-----------------------------|
| MBR140ESFT1G  | SOD-123FL<br>(Pb-Free) | 3,000 /<br>Tape & Reel **   |
| MBR140ESFT3G  | SOD-123FL<br>(Pb-Free) | 10,000 /<br>Tape & Reel *** |
| NRVB140ESFT1G | SOD-123FL<br>(Pb-Free) | 3,000 /<br>Tape & Reel **   |
| NRVB140ESFT3G | SOD-123FL<br>(Pb-Free) | 10,000 /<br>Tape & Reel *** |

†For information on tape and reel specifications, including part orientation and tape sizes, please refer to our Tape and Reel Packaging Specifications Brochure, BRD8011/D.

\*\* 8 mm Tape, 7" Reel

\*\*\* 8 mm Tape, 13" Reel

# MBR140ESF, NRVB140ESF

## MAXIMUM RATINGS

| Rating  | Symbol                          | Value      | Unit |
|---|---------------------------------|------------|------|
| Peak Repetitive Reverse Voltage<br>Working Peak Reverse Voltage<br>DC Blocking Voltage                  | $V_{RRM}$<br>$V_{RWM}$<br>$V_R$ | 40         | V    |
| Average Rectified Forward Current   | $I_O$                           | 1.0        | A    |
| Peak Repetitive Forward Current   | $I_{FRM}$                       | 2.0        | A    |
| Non-Repetitive Peak Surge Current<br>(Non-Repetitive peak surge current, halfwave, single phase, 60 Hz) | $I_{FSM}$                       | 30         | A    |
| Storage Temperature   | $T_{stg}$                       | -55 to 175 | °C   |
| Operating Junction Temperature  | $T_J$                           | -55 to 175 | °C   |

Stresses exceeding those listed in the Maximum Ratings table may damage the device. If any of these limits are exceeded, device functionality should not be assumed, damage may occur and reliability may be affected.

## THERMAL CHARACTERISTICS

| Characteristic                                   | Symbol    | Value | Unit |
|--|-----------|-------|------|
| Thermal Resistance, Junction-to-Lead (Note 1)    | $R_{tjl}$ | 26    | °C/W |
| Thermal Resistance, Junction-to-Lead (Note 2)    | $R_{tjl}$ | 21    |      |
| Thermal Resistance, Junction-to-Ambient (Note 1) | $R_{tja}$ | 325   |      |
| Thermal Resistance, Junction-to-Ambient (Note 2) | $R_{tja}$ | 82    |      |

1. Mounted with minimum recommended pad size, PC Board FR4.
2. Mounted with 1 in. copper pad (Cu area 700 mm<sup>2</sup>).

## ELECTRICAL CHARACTERISTICS

| Characteristic   | Symbol | Value                    | Unit |
|--|--------|--------------------------|------|
| Maximum Instantaneous Forward Voltage (Note 3)<br>( $I_F = 1.0$ A) | $V_F$  | $T_J = 25^\circ\text{C}$ | V    |
|  |        | 0.56                     |      |
| Maximum Instantaneous Reverse Current (Note 3)<br>( $V_R = 40$ V)  | $I_R$  | $T_J = 25^\circ\text{C}$ | μA   |
|  |        | 30                       |      |

3. Pulse Test: Pulse Width ≤ 250 μs, Duty Cycle ≤ 2%.

# MBR140ESF, NRVB140ESF

## TYPICAL CHARACTERISTICS

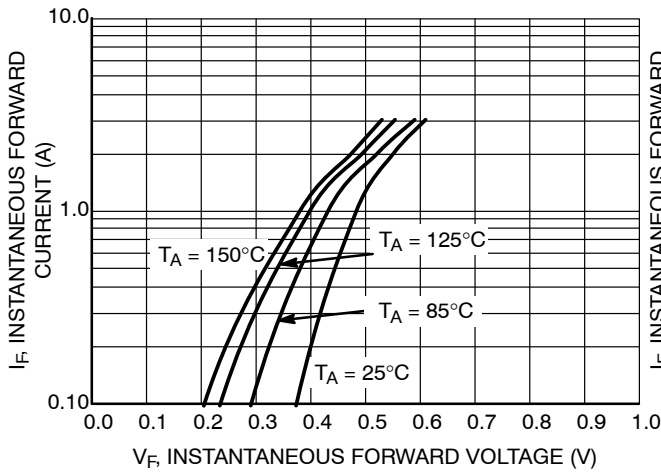

**Figure 1. Typical Instantaneous Forward Characteristics**

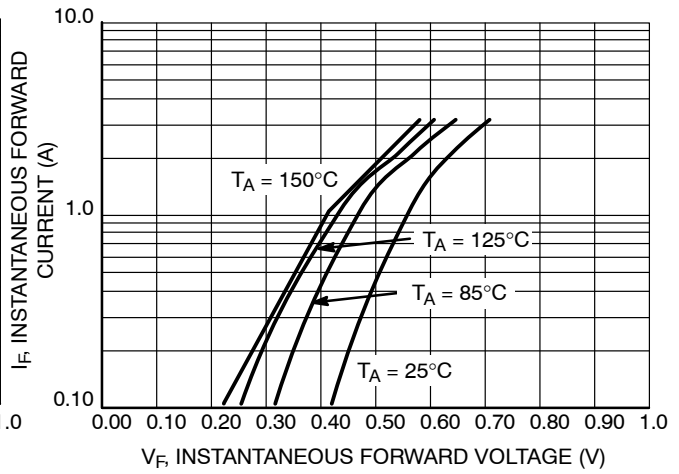

**Figure 2. Maximum Instantaneous Forward Characteristics**

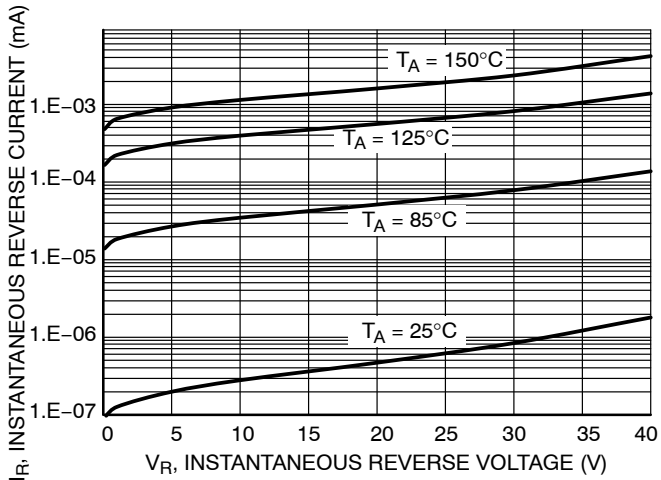

**Figure 3. Typical Reverse Characteristics**

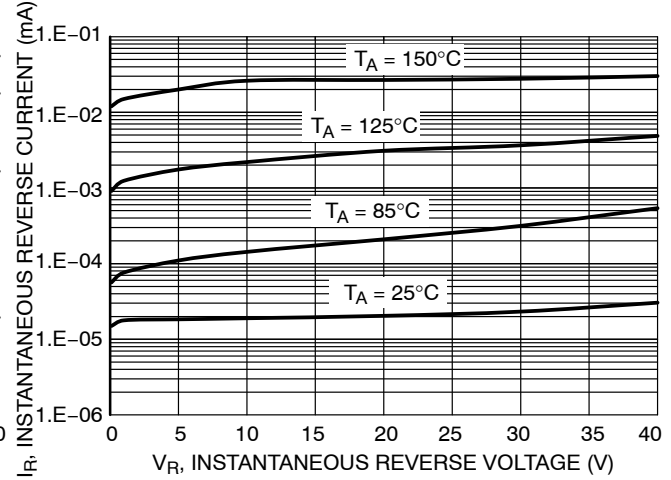

**Figure 4. Maximum Reverse Characteristics**

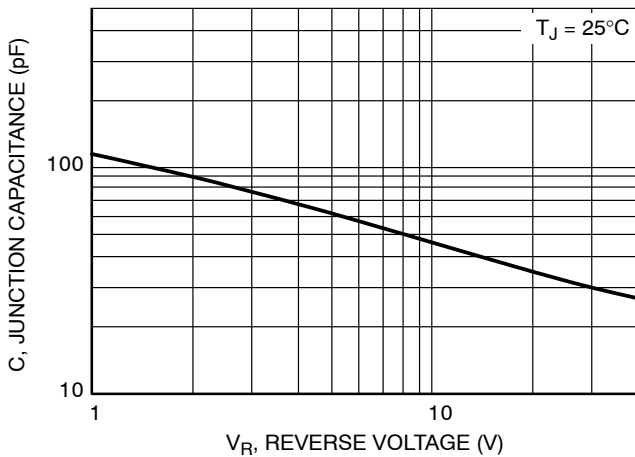

**Figure 5. Typical Junction Capacitance**

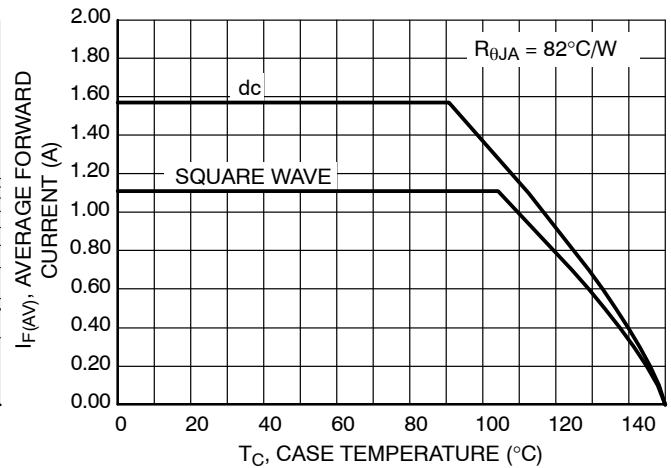

**Figure 6. Current Derating, Case**

# MBR140ESF, NRVB140ESF

## TYPICAL CHARACTERISTICS

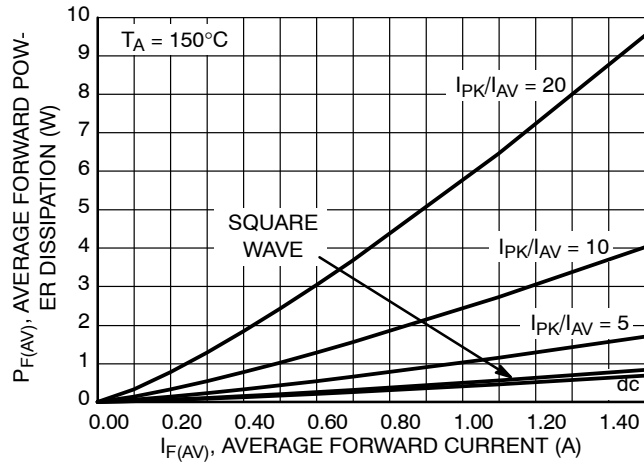

Figure 7. Forward Power Dissipation

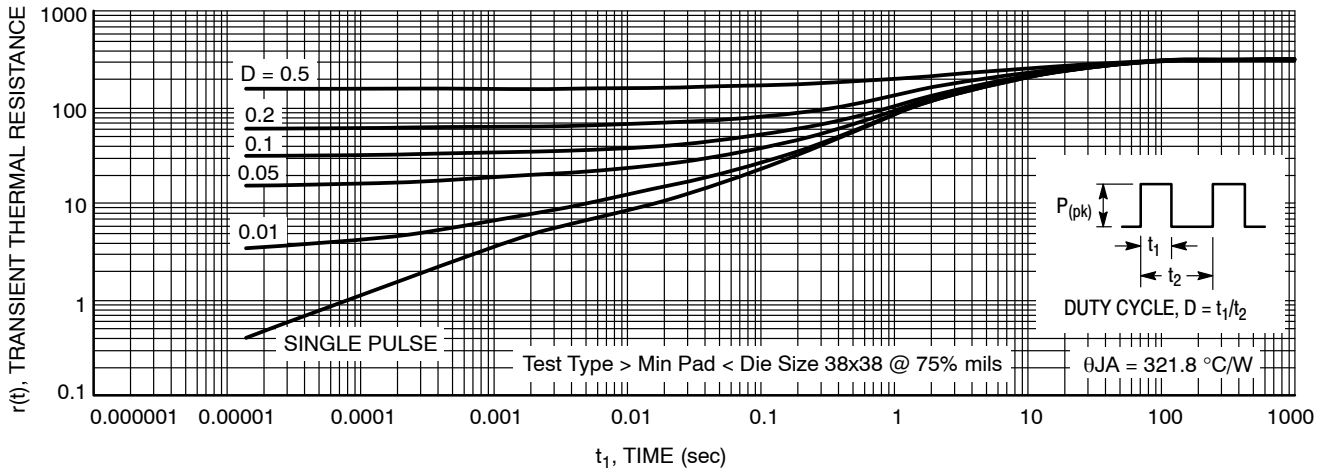
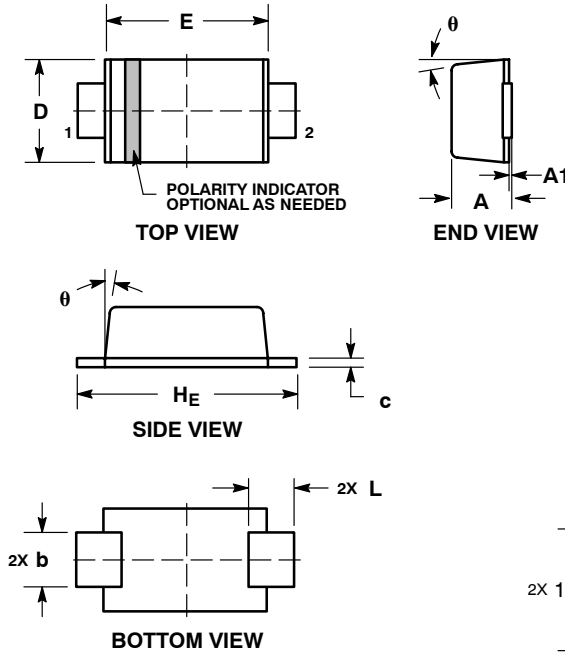

Figure 8. Thermal Response

# MBR140ESF, NRVB140ESF

## PACKAGE DIMENSIONS

SOD-123FL  
CASE 498  
ISSUE D



NOTES:

1. DIMENSIONING AND TOLERANCING PER ANSI Y14.5M, 1982.
2. CONTROLLING DIMENSION: MILLIMETER.
3. DIMENSIONS A AND B DO NOT INCLUDE MOLD FLASH.
4. DIMENSIONS D AND J ARE TO BE MEASURED ON FLAT SECTION OF THE LEAD: BETWEEN 0.10 AND 0.25 MM FROM THE LEAD TIP.

| DIM            | MILLIMETERS |      |      | INCHES |       |       |
|----------------|-------------|------|------|--------|-------|-------|
|                | MIN         | NOM  | MAX  | MIN    | NOM   | MAX   |
| A              | 0.90        | 0.95 | 0.98 | 0.035  | 0.037 | 0.039 |
| A1             | 0.00        | 0.05 | 0.10 | 0.000  | 0.002 | 0.004 |
| b              | 0.70        | 0.90 | 1.10 | 0.028  | 0.035 | 0.043 |
| c              | 0.10        | 0.15 | 0.20 | 0.004  | 0.006 | 0.008 |
| D              | 1.50        | 1.65 | 1.80 | 0.059  | 0.065 | 0.071 |
| E              | 2.50        | 2.70 | 2.90 | 0.098  | 0.106 | 0.114 |
| L              | 0.55        | 0.75 | 0.95 | 0.022  | 0.030 | 0.037 |
| H <sub>E</sub> | 3.40        | 3.60 | 3.80 | 0.134  | 0.142 | 0.150 |
| $\theta$       | 0°          | -    | 8°   | 0°     | -     | 8°    |

### RECOMMENDED SOLDERING FOOTPRINT\*

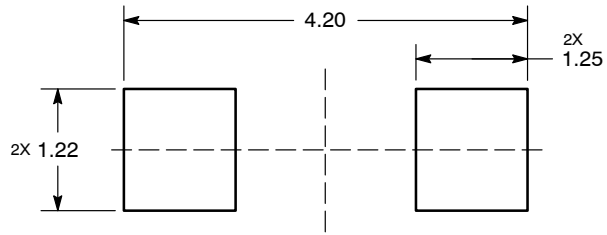

DIMENSIONS: MILLIMETERS

\*For additional information on our Pb-Free strategy and soldering details, please download the ON Semiconductor Soldering and Mounting Techniques Reference Manual, SOLDERRM/D.

ON Semiconductor and are registered trademarks of Semiconductor Components Industries, LLC (SCILLC). SCILLC owns the rights to a number of patents, trademarks, copyrights, trade secrets, and other intellectual property. A listing of SCILLC's product/patent coverage may be accessed at [www.onsemi.com/site/pdf/Patent-Marking.pdf](http://www.onsemi.com/site/pdf/Patent-Marking.pdf). SCILLC reserves the right to make changes without further notice to any products herein. SCILLC makes no warranty, representation or guarantee regarding the suitability of its products for any particular purpose, nor does SCILLC assume any liability arising out of the application or use of any product or circuit, and specifically disclaims any and all liability, including without limitation special, consequential or incidental damages. "Typical" parameters which may be provided in SCILLC data sheets and/or specifications can and do vary in different applications and actual performance may vary over time. All operating parameters, including "Typicals" must be validated for each customer application by customer's technical experts. SCILLC does not convey any license under its patent rights nor the rights of others. SCILLC products are not designed, intended, or authorized for use as components in systems intended for surgical implant into the body, or other applications intended to support or sustain life, or for any other application in which the failure of the SCILLC product could create a situation where personal injury or death may occur. Should Buyer purchase or use SCILLC products for any such unintended or unauthorized application, Buyer shall indemnify and hold SCILLC and its officers, employees, subsidiaries, affiliates, and distributors harmless against all claims, costs, damages, and expenses, and reasonable attorney fees arising out of, directly or indirectly, any claim of personal injury or death associated with such unintended or unauthorized use, even if such claim alleges that SCILLC was negligent regarding the design or manufacture of the part. SCILLC is an Equal Opportunity/Affirmative Action Employer. This literature is subject to all applicable copyright laws and is not for resale in any manner.

### PUBLICATION ORDERING INFORMATION

**LITERATURE FULFILLMENT:**  
Literature Distribution Center for ON Semiconductor  
P.O. Box 5163, Denver, Colorado 80217 USA  
**Phone:** 303-675-2175 or 800-344-3860 Toll Free USA/Canada  
**Fax:** 303-675-2176 or 800-344-3867 Toll Free USA/Canada  
**Email:** [orderlit@onsemi.com](mailto:orderlit@onsemi.com)

**N. American Technical Support:** 800-282-9855 Toll Free  
USA/Canada  
**Europe, Middle East and Africa Technical Support:**  
Phone: 421 33 790 2910  
**Japan Customer Focus Center**  
Phone: 81-3-5817-1050

**ON Semiconductor Website:** [www.onsemi.com](http://www.onsemi.com)  
**Order Literature:** <http://www.onsemi.com/orderlit>  
For additional information, please contact your local Sales Representative

Компания «Океан Электроники» предлагает заключение долгосрочных отношений при поставках импортных электронных компонентов на взаимовыгодных условиях!

Наши преимущества:

- Поставка оригинальных импортных электронных компонентов напрямую с производств Америки, Европы и Азии, а так же с крупнейших складов мира;
- Широкая линейка поставок активных и пассивных импортных электронных компонентов (более 30 млн. наименований);
- Поставка сложных, дефицитных, либо снятых с производства позиций;
- Оперативные сроки поставки под заказ (от 5 рабочих дней);
- Экспресс доставка в любую точку России;
- Помощь Конструкторского Отдела и консультации квалифицированных инженеров;
- Техническая поддержка проекта, помощь в подборе аналогов, поставка прототипов;
- Поставка электронных компонентов под контролем ВП;
- Система менеджмента качества сертифицирована по Международному стандарту ISO 9001;
- При необходимости вся продукция военного и аэрокосмического назначения проходит испытания и сертификацию в лаборатории (по согласованию с заказчиком);
- Поставка специализированных компонентов военного и аэрокосмического уровня качества (Xilinx, Altera, Analog Devices, Intersil, Interpoint, Microsemi, Actel, Aeroflex, Peregrine, VPT, Syfer, Eurofarad, Texas Instruments, MS Kennedy, Miteq, Cobham, E2V, MA-COM, Hittite, Mini-Circuits, General Dynamics и др.);

Компания «Океан Электроники» является официальным дистрибьютором и эксклюзивным представителем в России одного из крупнейших производителей разъемов военного и аэрокосмического назначения «JONHON», а так же официальным дистрибьютором и эксклюзивным представителем в России производителя высокотехнологичных и надежных решений для передачи СВЧ сигналов «FORSTAR».



## JONHON

«JONHON» (основан в 1970 г.)

Разъемы специального, военного и аэрокосмического назначения:

(Применяются в военной, авиационной, аэрокосмической, морской, железнодорожной, горно- и нефтедобывающей отраслях промышленности)

«FORSTAR» (основан в 1998 г.)

ВЧ соединители, коаксиальные кабели, кабельные сборки и микроволновые компоненты:

(Применяются в телекоммуникациях гражданского и специального назначения, в средствах связи, РЛС, а так же военной, авиационной и аэрокосмической отраслях промышленности).



Телефон: 8 (812) 309-75-97 (многоканальный)

Факс: 8 (812) 320-03-32

Электронная почта: [ocean@oceanchips.ru](mailto:ocean@oceanchips.ru)

Web: <http://oceanchips.ru/>

Адрес: 198099, г. Санкт-Петербург, ул. Калинина, д. 2, корп. 4, лит. А