

A large, light blue decorative graphic consisting of a thick, curved line that forms a partial circle, with a small circle at its top end.

LED Driver

BCR320U / BCR321U

Datasheet

Revision 2.0, 2012-05-04

Power Management & Multimarket

**Edition 2012-05-04**

**Published by  
Infineon Technologies AG  
81726 Munich, Germany**

**© 2012 Infineon Technologies AG  
All Rights Reserved.**

### **Legal Disclaimer**

The information given in this document shall in no event be regarded as a guarantee of conditions or characteristics. With respect to any examples or hints given herein, any typical values stated herein and/or any information regarding the application of the device, Infineon Technologies hereby disclaims any and all warranties and liabilities of any kind, including without limitation, warranties of non-infringement of intellectual property rights of any third party.

### **Information**

For further information on technology, delivery terms and conditions and prices, please contact the nearest Infineon Technologies Office ([www.infineon.com](http://www.infineon.com)).

### **Warnings**

Due to technical requirements, components may contain dangerous substances. For information on the types in question, please contact the nearest Infineon Technologies Office.

Infineon Technologies components may be used in life-support devices or systems only with the express written approval of Infineon Technologies, if a failure of such components can reasonably be expected to cause the failure of that life-support device or system or to affect the safety or effectiveness of that device or system. Life support devices or systems are intended to be implanted in the human body or to support and/or maintain and sustain and/or protect human life. If they fail, it is reasonable to assume that the health of the user or other persons may be endangered.

**Revision History**

| Page or Item                    | Subjects (major changes since previous revision) |
|---------------------------------|--|
| <b>Revision 2.0, 2012-05-04</b> |  |
| All                             | Datasheet layout updated                         |
| <b>Table 2-3</b>                | $R_{int}$ limits tightened                       |
| <b>Table 2-3</b>                | $I_{out}$ limits tightened                       |

**Trademarks of Infineon Technologies AG**

AURIX™, C166™, CanPAK™, CIPOS™, CIPURSE™, EconoPACK™, CoolMOS™, CoolSET™, CORECONTROL™, CROSSAVE™, DAVE™, DI-POL™, EasyPIM™, EconoBRIDGE™, EconoDUAL™, EconoPIM™, EconoPACK™, EiceDRIVER™, eupec™, FCOS™, HITFET™, HybridPACK™, I<sup>2</sup>RF™, ISOFACE™, IsoPACK™, MIPAQ™, ModSTACK™, my-d™, NovalithIC™, OptiMOS™, ORIGA™, POWERCODE™, PRIMARION™, PrimePACK™, PrimeSTACK™, PRO-SIL™, PROFET™, RASIC™, ReverSave™, SatRIC™, SIEGET™, SINDRION™, SIPMOS™, SmartLEWIS™, SOLID FLASH™, TEMPFET™, thinQ!™, TRENCHSTOP™, TriCore™.

**Other Trademarks**

Advance Design System™ (ADS) of Agilent Technologies, AMBA™, ARM™, MULTI-ICE™, KEIL™, PRIMECELL™, REALVIEW™, THUMB™,  $\mu$ Vision™ of ARM Limited, UK. AUTOSAR™ is licensed by AUTOSAR development partnership. Bluetooth™ of Bluetooth SIG Inc. CAT-iq™ of DECT Forum. COLOSSUS™, FirstGPS™ of Trimble Navigation Ltd. EMV™ of EMVCo, LLC (Visa Holdings Inc.). EPCOS™ of Epcos AG. FLEXGO™ of Microsoft Corporation. FlexRay™ is licensed by FlexRay Consortium. HYPERTERMINAL™ of Hilgraeve Incorporated. IEC™ of Commission Electrotechnique Internationale. IrDA™ of Infrared Data Association Corporation. ISO™ of INTERNATIONAL ORGANIZATION FOR STANDARDIZATION. MATLAB™ of MathWorks, Inc. MAXIM™ of Maxim Integrated Products, Inc. MICROTEC™, NUCLEUS™ of Mentor Graphics Corporation. MIPI™ of MIPI Alliance, Inc. MIPS™ of MIPS Technologies, Inc., USA. muRata™ of MURATA MANUFACTURING CO., MICROWAVE OFFICE™ (MWO) of Applied Wave Research Inc., OmniVision™ of OmniVision Technologies, Inc. Openwave™ Openwave Systems Inc. RED HAT™ Red Hat, Inc. RFMD™ RF Micro Devices, Inc. SIRIUS™ of Sirius Satellite Radio Inc. SOLARIS™ of Sun Microsystems, Inc. SPANSION™ of Spansion LLC Ltd. Symbian™ of Symbian Software Limited. TAIYO YUDEN™ of Taiyo Yuden Co. TEAKLITE™ of CEVA, Inc. TEKTRONIX™ of Tektronix Inc. TOKO™ of TOKO KABUSHIKI KAISHA TA. UNIX™ of X/Open Company Limited. VERILOG™, PALLADIUM™ of Cadence Design Systems, Inc. VLYNQ™ of Texas Instruments Incorporated. VXWORKS™, WIND RIVER™ of WIND RIVER SYSTEMS, INC. ZETEX™ of Diodes Zetex Limited.

Last Trademarks Update 2011-11-11

## Table of Contents

|          |   |    |
|----------|---|----|
|          | <b>Table of Contents</b> .....          | 4  |
|          | <b>List of Figures</b> .....            | 5  |
|          | <b>List of Tables</b> .....             | 6  |
| <b>1</b> | <b>LED Driver</b> .....                 | 7  |
| 1.1      | Features .....                          | 7  |
| 1.2      | Applications .....                      | 7  |
| 1.3      | General Description .....               | 7  |
| <b>2</b> | <b>Electrical Characteristics</b> ..... | 9  |
| <b>3</b> | <b>Typical characteristics</b> .....    | 11 |
| <b>4</b> | <b>Application hints</b> .....          | 23 |
| <b>5</b> | <b>Package</b> .....                    | 24 |
|          | <b>Terminology</b> .....                | 25 |

## List of Figures

|             |  |    |
|-------------|--|----|
| Figure 1-1  | Pin configuration and typical application. . . . .   | 8  |
| Figure 3-1  | Total Power Dissipation $P_{tot} = f(T_S)$ . . . . .   | 11 |
| Figure 3-2  | Permissible Pulse Load $R_{thJS} = f(t_p)$ . . . . .   | 11 |
| Figure 3-3  | Permissible Pulse Load $P_{totmax} / P_{totDC} = f(t_p)$ . . . . .   | 12 |
| Figure 3-4  | BCR320U: Output Current versus $V_{out} I_{out} = f(V_{out})$ , $V_{EN} = 12\text{ V}$ , $R_{ext} = \text{Parameter}$ . . . . .                        | 13 |
| Figure 3-5  | BCR320U: Output Current versus $R_{ext} I_{out} = f(R_{ext})$ , $V_{EN} = 12\text{ V}$ , $V_{out} = \text{Parameter}$ . . . . .                        | 13 |
| Figure 3-6  | BCR320U: Output Current versus $V_{out} I_{out} = f(V_{out})$ , $V_{EN} = 12\text{ V}$ , $R_{ext} = \text{open}$ , $T_A = \text{Parameter}$ . . . . .  | 14 |
| Figure 3-7  | BCR320U: Output Current versus $V_{out} I_{out} = f(V_{out})$ , $V_{EN} = 12\text{ V}$ , $R_{ext} = 20\ \Omega$ , $T_A = \text{Parameter}$ . . . . .   | 14 |
| Figure 3-8  | BCR320U: Output Current versus $V_{out} I_{out} = f(V_{out})$ , $V_{EN} = 12\text{ V}$ , $R_{ext} = 3\ \Omega$ , $T_A = \text{Parameter}$ . . . . .    | 15 |
| Figure 3-9  | BCR320U: Output Current versus $V_{EN} I_{out} = f(V_{EN})$ , $V_{out} = 2\text{ V}$ , $R_{ext} = \text{open}$ , $T_A = \text{Parameter}$ . . . . .    | 15 |
| Figure 3-10 | BCR320U: Output Current versus $V_{EN} I_{out} = f(V_{EN})$ , $V_{out} = 2\text{ V}$ , $R_{ext} = 20\ \Omega$ , $T_A = \text{Parameter}$ . . . . .     | 16 |
| Figure 3-11 | BCR320U: Output Current versus $V_{EN} I_{out} = f(V_{EN})$ , $V_{out} = 2\text{ V}$ , $R_{ext} = 3\ \Omega$ , $T_A = \text{Parameter}$ . . . . .      | 16 |
| Figure 3-12 | BCR320U: Output Current versus $V_{EN} I_{out} = f(V_{EN})$ , $V_{out} = 2\text{ V}$ , $R_{ext} = \text{Parameter}$ . . . . .                          | 17 |
| Figure 3-13 | BCR320U: Enable Current versus $V_{EN} I_{EN} = f(V_{EN})$ , $R_{ext} = \text{open}$ , $I_{out} = 0\text{ A}$ , $T_A = \text{Parameter}$ . . . . .     | 17 |
| Figure 3-14 | BCR321U: Output Current versus $V_{out} I_{out} = f(V_{out})$ , $V_{EN} = 3.3\text{ V}$ , $R_{ext} = \text{Parameter}$ . . . . .                       | 18 |
| Figure 3-15 | BCR321U: Output Current versus $R_{ext} I_{out} = f(R_{ext})$ , $V_{EN} = 3.3\text{ V}$ , $V_{out} = \text{Parameter}$ . . . . .                       | 18 |
| Figure 3-16 | BCR321U: Output Current versus $V_{out} I_{out} = f(V_{out})$ , $V_{EN} = 3.3\text{ V}$ , $R_{ext} = \text{open}$ , $T_A = \text{Parameter}$ . . . . . | 19 |
| Figure 3-17 | BCR321U: Output Current versus $V_{out} I_{out} = f(V_{out})$ , $V_{EN} = 3.3\text{ V}$ , $R_{ext} = 20\ \Omega$ , $T_A = \text{Parameter}$ . . . . .  | 19 |
| Figure 3-18 | BCR321U: Output Current versus $V_{out} I_{out} = f(V_{out})$ , $V_{EN} = 3.3\text{ V}$ , $R_{ext} = 3\ \Omega$ , $T_A = \text{Parameter}$ . . . . .   | 20 |
| Figure 3-19 | BCR321U: Output Current versus $V_{EN} I_{out} = f(V_{EN})$ , $V_{out} = 2\text{ V}$ , $R_{ext} = \text{open}$ , $T_A = \text{Parameter}$ . . . . .    | 20 |
| Figure 3-20 | BCR321U: Output Current versus $V_{EN} I_{out} = f(V_{EN})$ , $V_{out} = 2\text{ V}$ , $R_{ext} = 20\ \Omega$ , $T_A = \text{Parameter}$ . . . . .     | 21 |
| Figure 3-21 | BCR321U: Output Current versus $V_{EN} I_{out} = f(V_{EN})$ , $V_{out} = 2\text{ V}$ , $R_{ext} = 3\ \Omega$ , $T_A = \text{Parameter}$ . . . . .      | 21 |
| Figure 3-22 | BCR321U: Output Current versus $V_{EN} I_{out} = f(V_{EN})$ , $V_{out} = 2\text{ V}$ , $R_{ext} = \text{Parameter}$ . . . . .                          | 22 |
| Figure 3-23 | BCR321U: Enable Current versus $V_{EN} I_{EN} = f(V_{EN})$ , $R_{ext} = \text{open}$ , $I_{out} = 0\text{ A}$ , $T_A = \text{Parameter}$ . . . . .     | 22 |
| Figure 4-1  | Application Circuit: Enabling / PWM by Micro Controller . . . . .  | 23 |
| Figure 4-2  | Application Circuit: Enabling by Connecting to $V_S$ . . . . .   | 23 |
| Figure 5-1  | Package Outline for SC74 (dimensions in mm) . . . . .  | 24 |
| Figure 5-2  | Package Footprint for SC74 (dimensions in mm) . . . . .  | 24 |
| Figure 5-3  | Tape and Reel Information for SC74 (dimensions in mm) . . . . .  | 24 |

## List of Tables

|           |  |    |
|-----------|--|----|
| Table 2-1 | Maximum Ratings at $T_A = 25\text{ °C}$ , unless otherwise specified                             | 9  |
| Table 2-2 | Thermal Resistance at $T_A = 25\text{ °C}$ , unless otherwise specified                          | 9  |
| Table 2-3 | Electrical Characteristics at $T_A = 25\text{ °C}$ , unless otherwise specified                  | 9  |
| Table 2-4 | DC Characteristics with stabilized LED load at $T_A = 25\text{ °C}$ , unless otherwise specified | 10 |

## 1 LED Driver

### 1.1 Features

- LED drive current preset to 10 mA
- Continuous output current up to 250 mA with an external resistor
- Easy paralleling of drivers to increase current
- Supply voltage up to 25 V
- Low side current control
- Digital PWM input up to 10 kHz frequency (BCR321U)
- Up to 1 W power dissipation in a small SC74 package
- Negative thermal coefficient of -0.2 %/K reduces output current at higher temperatures
- RoHS compliant (Pb-free) package
- Automotive qualified according AEC Q101



SC74-3D



### 1.2 Applications

- Architectural LED lighting
- Channel letters for advertising, LED strips for decorative lighting
- Retail lighting in fridge, freezer case and vending machines
- Emergency lighting (e.g. steps lighting, exit way signs etc.)

### 1.3 General Description

The BCR320U / BCR321U provides a low-cost solution for driving 0.5 W LEDs with a typical LED current of 150 mA to 200 mA. Internal breakdown voltage is higher than 16 V which is the maximum voltage the LED driver can sustain when the output is directly connected to supply voltage.

The BCR320U / BCR321U can be operated with a supply voltage of more than 16 V considering the voltage drop of the LED load which reduces the output voltage to the maximum rating of the driver.

The enable pin of BCR320U can withstand a maximum voltage of 25 V which can be increased adding a series resistor in front of the enable pin reducing the voltage at the enable pin below 25 V.

The digital input pin of BCR321U allows dimming via a micro controller with frequencies up to 10 kHz.

A reduction of the output current at higher temperatures is the result of the negative temperature coefficient of -0.2 %/K of the LED driver.

With no need for additional external components like inductors, capacitors and free wheeling diodes, the BCR320U / BCR321U LED drivers are a cost-efficient and PCB-area saving solution for driving 0.5 W LEDs.

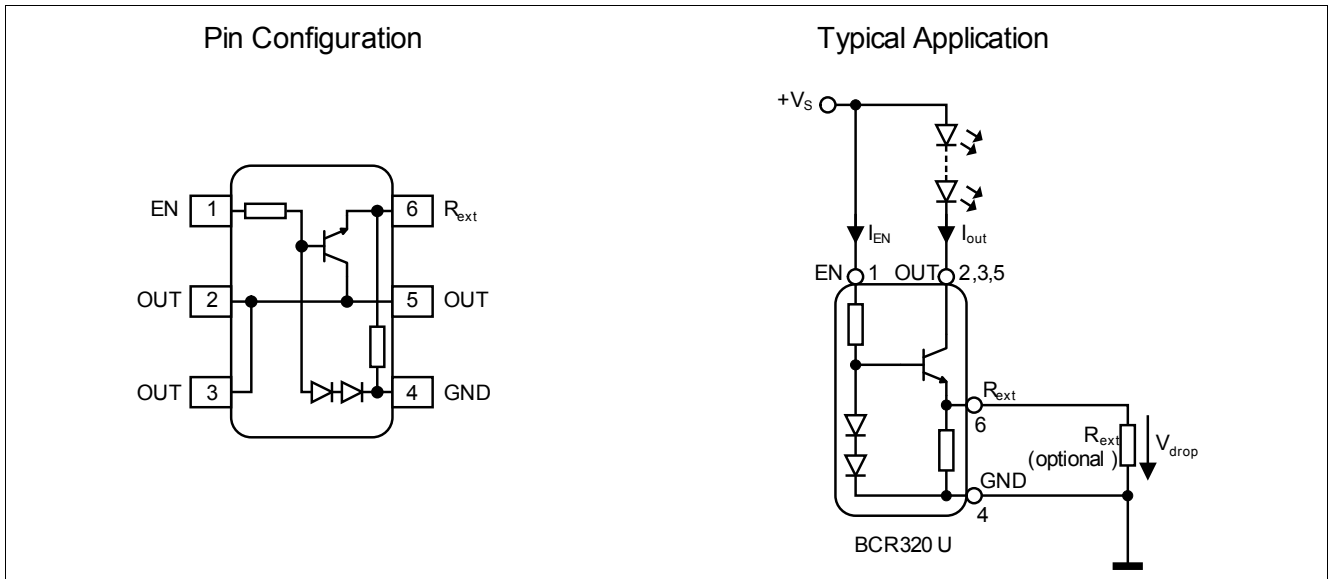

Figure 1-1 Pin configuration and typical application

| Type    | Marking | Pin Configuration |               |         |                      | Package |
|---------|---------|-------------------|---------------|---------|----------------------|---------|
|         |         | 1 = EN            | 2; 3; 5 = OUT | 4 = GND | 6 = R <sub>ext</sub> |         |
| BCR320U | 30      | 1 = EN            | 2; 3; 5 = OUT | 4 = GND | 6 = R <sub>ext</sub> | SC74    |
| BCR321U | 31      | 1 = EN            | 2; 3; 5 = OUT | 4 = GND | 6 = R <sub>ext</sub> | SC74    |



## 2 Electrical Characteristics

**Table 2-1 Maximum Ratings at  $T_A = 25\text{ °C}$ , unless otherwise specified**

| Parameter                             | Symbol    | Values |      |           | Unit | Note / Test Condition    |
|---------------------------------------|-----------|--------|------|-----------|------|--------------------------|
|                                       |           | Min.   | Typ. | Max.      |      |                          |
| Enable voltage<br>BCR320U<br>BCR321U  | $V_{EN}$  | -      | -    | 25<br>4.5 | V    |                          |
| Output current                        | $I_{out}$ | -      | -    | 300       | mA   |                          |
| Output voltage                        | $V_{out}$ | -      | -    | 16        | V    |                          |
| Reverse voltage between all terminals | $V_R$     | -      | -    | 0.5       | V    |                          |
| Total power dissipation               | $P_{tot}$ | -      | -    | 1000      | mW   | $T_S \leq 100\text{ °C}$ |
| Junction temperature                  | $T_J$     | -      | -    | 150       | °C   |                          |
| Storage temperature range             | $T_{STG}$ | -65    | -    | 150       | °C   |                          |

**Attention: Stresses above the max. values listed here may cause permanent damage to the device. Exposure to absolute maximum rating conditions for extended periods may affect device reliability. Maximum ratings are absolute ratings; exceeding only one of these values may cause irreversible damage to the integrated circuit.**

**Table 2-2 Thermal Resistance at  $T_A = 25\text{ °C}$ , unless otherwise specified**

| Parameter                                | Symbol     | Values |      |      | Unit | Note / Test Condition |
|--|------------|--------|------|------|------|-----------------------|
|  |            | Min.   | Typ. | Max. |      |                       |
| Junction - soldering point <sup>1)</sup> | $R_{thJS}$ | -      | -    | 50   | K/W  |                       |

1) For calculation of  $R_{thJA}$  please refer to Application Note AN077 (Thermal Resistance Calculation)

**Table 2-3 Electrical Characteristics at  $T_A = 25\text{ °C}$ , unless otherwise specified**

| Parameter                            | Symbol        | Values |            |      | Unit       | Note / Test Condition                             |
|--------------------------------------|---------------|--------|------------|------|------------|---|
|                                      |               | Min.   | Typ.       | Max. |            |   |
| Collector-emitter breakdown voltage  | $V_{BR(CEO)}$ | 16     | -          | -    | V          | $I_C = 1\text{ mA}, I_B = 0$                      |
| Enable current<br>BCR320U<br>BCR321U | $I_{EN}$      | -      | 1.2<br>1.2 | -    | mA         | $V_{EN} = 12\text{ V}$<br>$V_{EN} = 3.3\text{ V}$ |
| DC current gain                      | $h_{FE}$      | 200    | 350        | 500  | -          | $I_C = 50\text{ mA}, V_{CE} = 1\text{ V}$         |
| Internal resistor                    | $R_{int}$     | 85     | 95         | 105  | $\Omega$   | $I_{Rint} = 10\text{ mA}$                         |
| Bias resistor<br>BCR320U<br>BCR321U  | $R_B$         | -      | 10<br>1.5  | -    | k $\Omega$ |   |

**Electrical Characteristics**
**Table 2-3 Electrical Characteristics at  $T_A = 25\text{ °C}$ , unless otherwise specified (cont'd)**

| Parameter   | Symbol     | Values |      |      | Unit | Note / Test Condition   |
|---|------------|--------|------|------|------|---|
|   |            | Min.   | Typ. | Max. |      |   |
| Output current<br>BCR320U<br>BCR321U                          | $I_{out}$  | 9      | 10   | 11   | mA   | $V_{out} = 1.4\text{ V}$<br>$V_{EN} = 12\text{ V}$<br>$V_{EN} = 3.3\text{ V}$ |
| Output current at $R_{ext} = 3\ \Omega$<br>BCR320U<br>BCR321U |            | -      | 250  | -    |      | $V_{out} > 1.4\text{ V}$<br>$V_{EN} = 12\text{ V}$<br>$V_{EN} = 3.3\text{ V}$ |
| Voltage drop ( $V_{Rext}$ )                                   | $V_{drop}$ | 0.85   | 0.95 | 1.05 | V    | $I_{out} = 10\text{ mA}$  |

**Table 2-4 DC Characteristics with stabilized LED load at  $T_A = 25\text{ °C}$ , unless otherwise specified**

| Parameter  | Symbol                   | Values |      |      | Unit | Note / Test Condition   |
|--|--------------------------|--------|------|------|------|---|
|  |                          | Min.   | Typ. | Max. |      |   |
| Lowest sufficient supply voltage overhead                | $V_{Smin}$               | -      | 1.4  | -    | V    | $I_{out} > 18\text{ mA}$  |
| Output current change versus $T_A$<br>BCR320U<br>BCR321U | $\Delta I_{out}/I_{out}$ | -      | -0.2 | -    | %K   | $V_{out} > 2.0\text{ V}$<br>$V_{EN} = 12\text{ V}$<br>$V_{EN} = 3.3\text{ V}$ |
| Output current change versus $V_S$<br>BCR320U<br>BCR321U |                          | -      | 1    | -    |      | %V  |

### 3 Typical characteristics

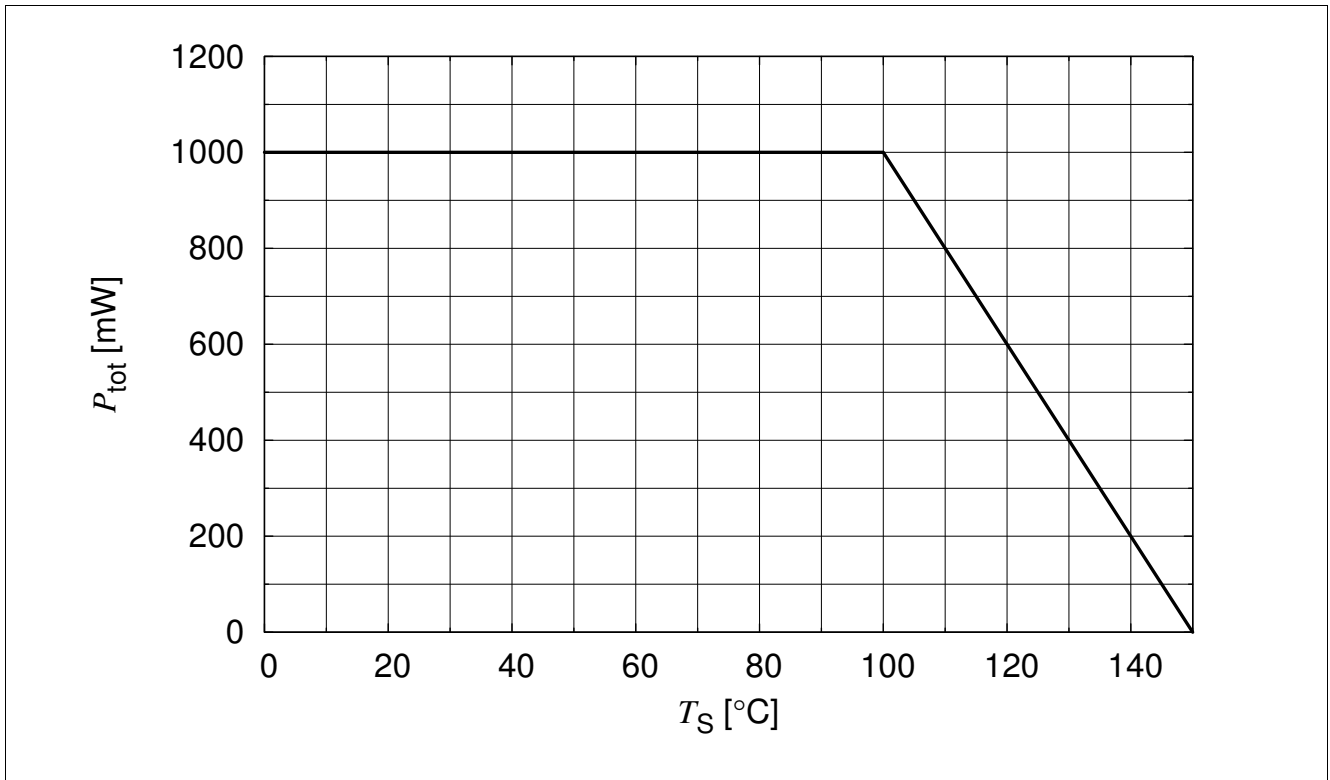

Figure 3-1 Total Power Dissipation  $P_{tot} = f(T_S)$

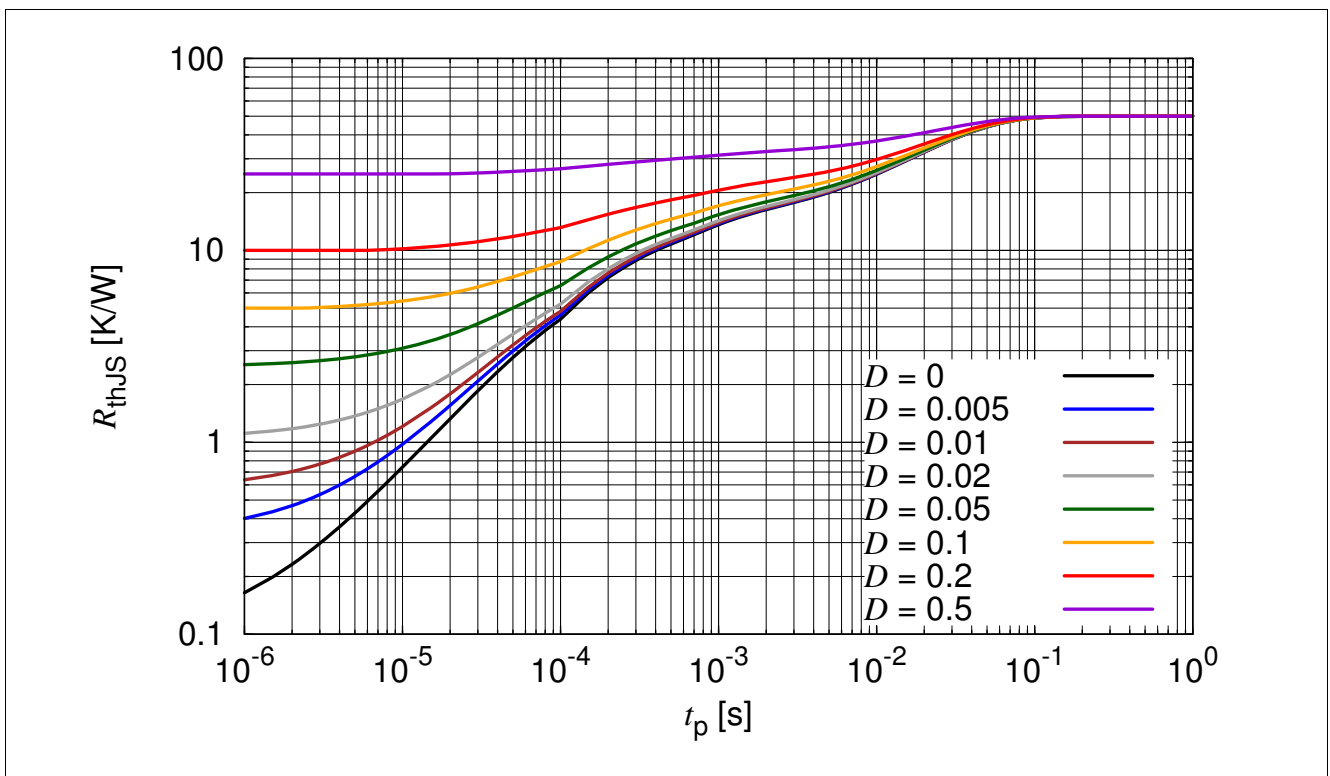

Figure 3-2 Permissible Pulse Load  $R_{thJS} = f(t_p)$



Figure 3-3 Permissible Pulse Load  $P_{totmax} / P_{totDC} = f(t_p)$



Figure 3-4 BCR320U: Output Current versus  $V_{out}$   $I_{out} = f(V_{out})$ ,  $V_{EN} = 12$  V,  $R_{ext} =$  Parameter



Figure 3-5 BCR320U: Output Current versus  $R_{ext}$   $I_{out} = f(R_{ext})$ ,  $V_{EN} = 12$  V,  $V_{out} =$  Parameter



Figure 3-6 BCR320U: Output Current versus  $V_{out}$   $I_{out} = f(V_{out})$ ,  $V_{EN} = 12\text{ V}$ ,  $R_{ext} = \text{open}$ ,  $T_A = \text{Parameter}$



Figure 3-7 BCR320U: Output Current versus  $V_{out}$   $I_{out} = f(V_{out})$ ,  $V_{EN} = 12\text{ V}$ ,  $R_{ext} = 20\ \Omega$ ,  $T_A = \text{Parameter}$



Figure 3-8 BCR320U: Output Current versus  $V_{out}$   $I_{out} = f(V_{out})$ ,  $V_{EN} = 12\text{ V}$ ,  $R_{ext} = 3\ \Omega$ ,  $T_A = \text{Parameter}$



Figure 3-9 BCR320U: Output Current versus  $V_{EN}$   $I_{out} = f(V_{EN})$ ,  $V_{out} = 2\text{ V}$ ,  $R_{ext} = \text{open}$ ,  $T_A = \text{Parameter}$

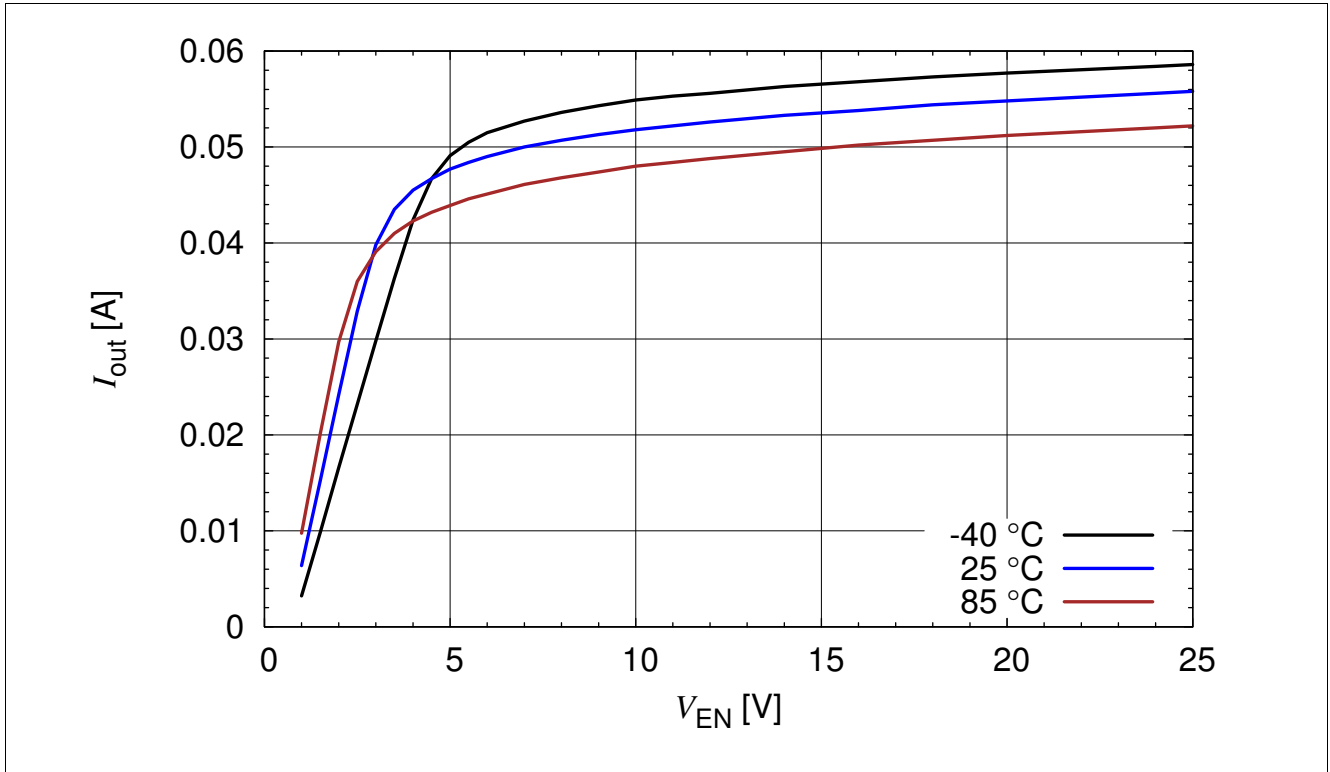

Figure 3-10 BCR320U: Output Current versus  $V_{EN}$   $I_{out} = f(V_{EN})$ ,  $V_{out} = 2\text{ V}$ ,  $R_{ext} = 20\ \Omega$ ,  $T_A = \text{Parameter}$

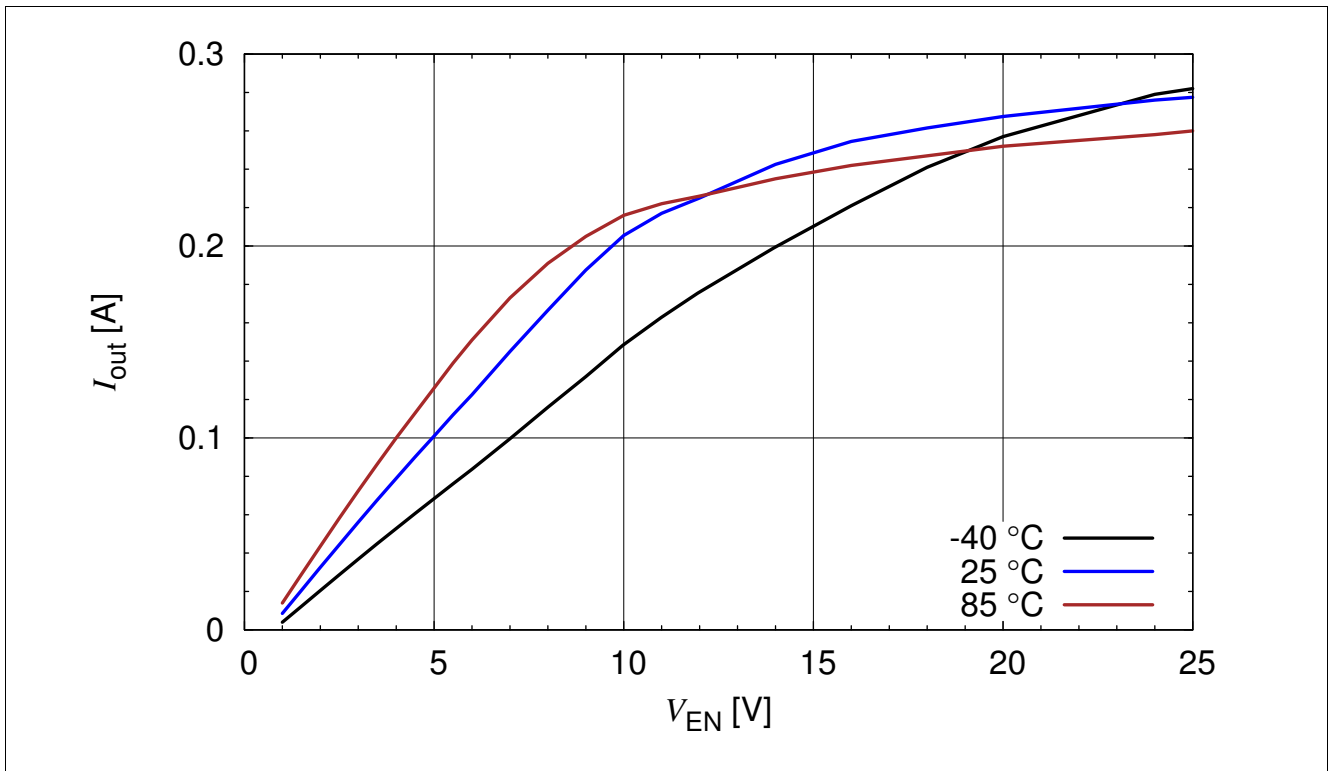

Figure 3-11 BCR320U: Output Current versus  $V_{EN}$   $I_{out} = f(V_{EN})$ ,  $V_{out} = 2\text{ V}$ ,  $R_{ext} = 3\ \Omega$ ,  $T_A = \text{Parameter}$



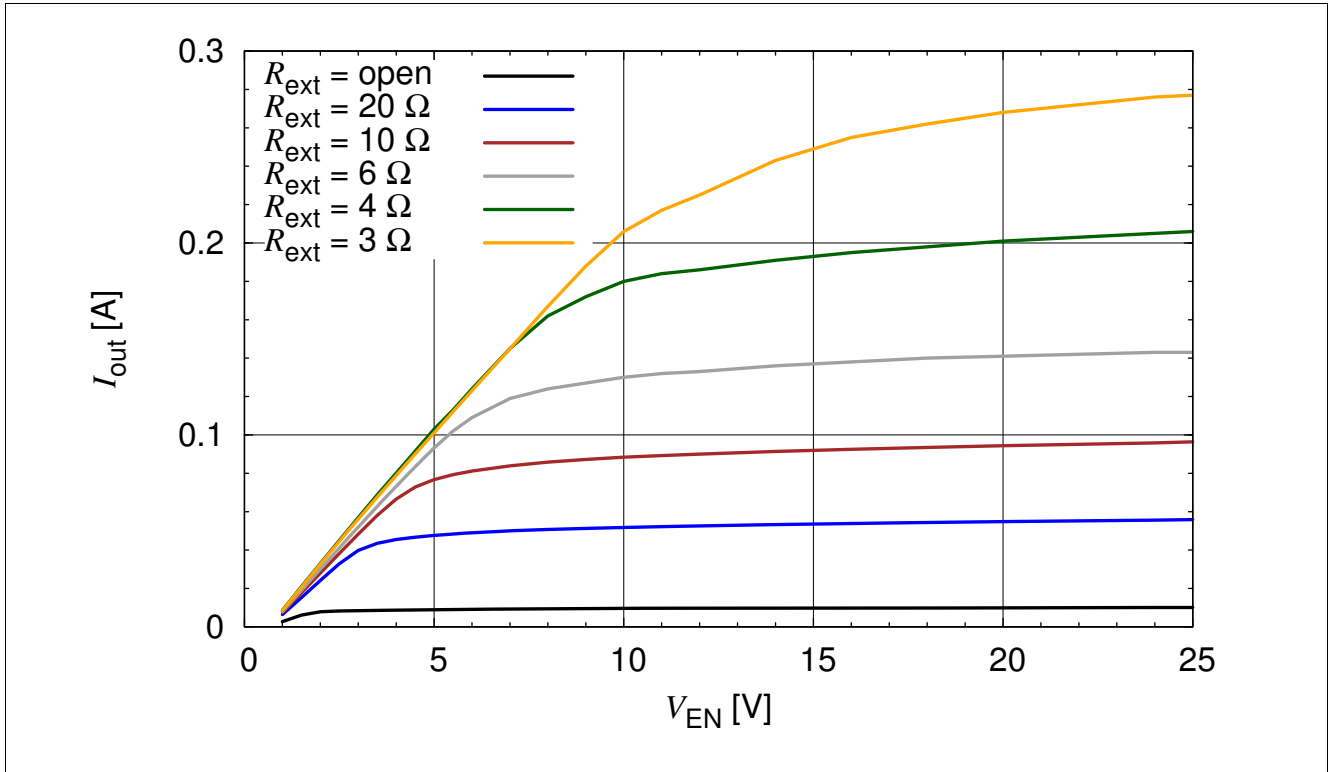

Figure 3-12 BCR320U: Output Current versus  $V_{EN}$   $I_{out} = f(V_{EN})$ ,  $V_{out} = 2\text{ V}$ ,  $R_{ext} = \text{Parameter}$

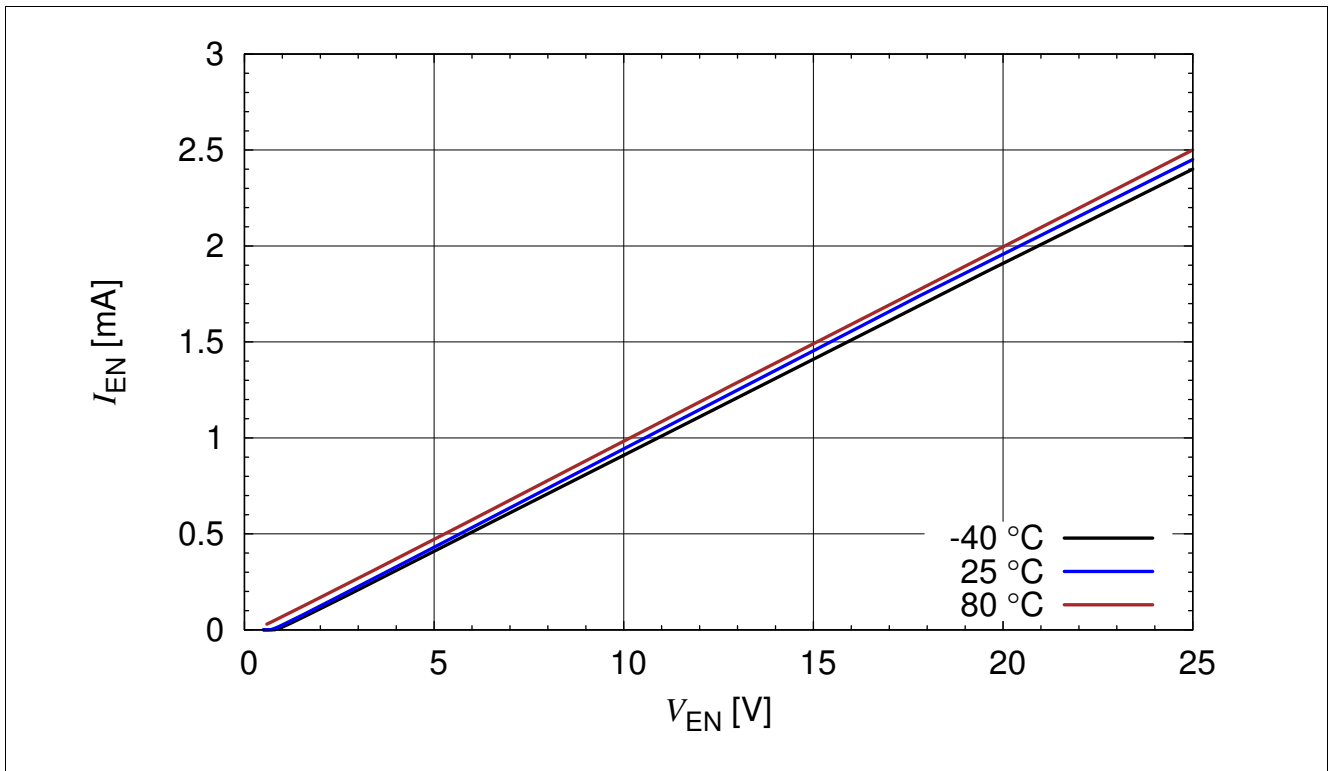

Figure 3-13 BCR320U: Enable Current versus  $V_{EN}$   $I_{EN} = f(V_{EN})$ ,  $R_{ext} = \text{open}$ ,  $I_{out} = 0\text{ A}$ ,  $T_A = \text{Parameter}$

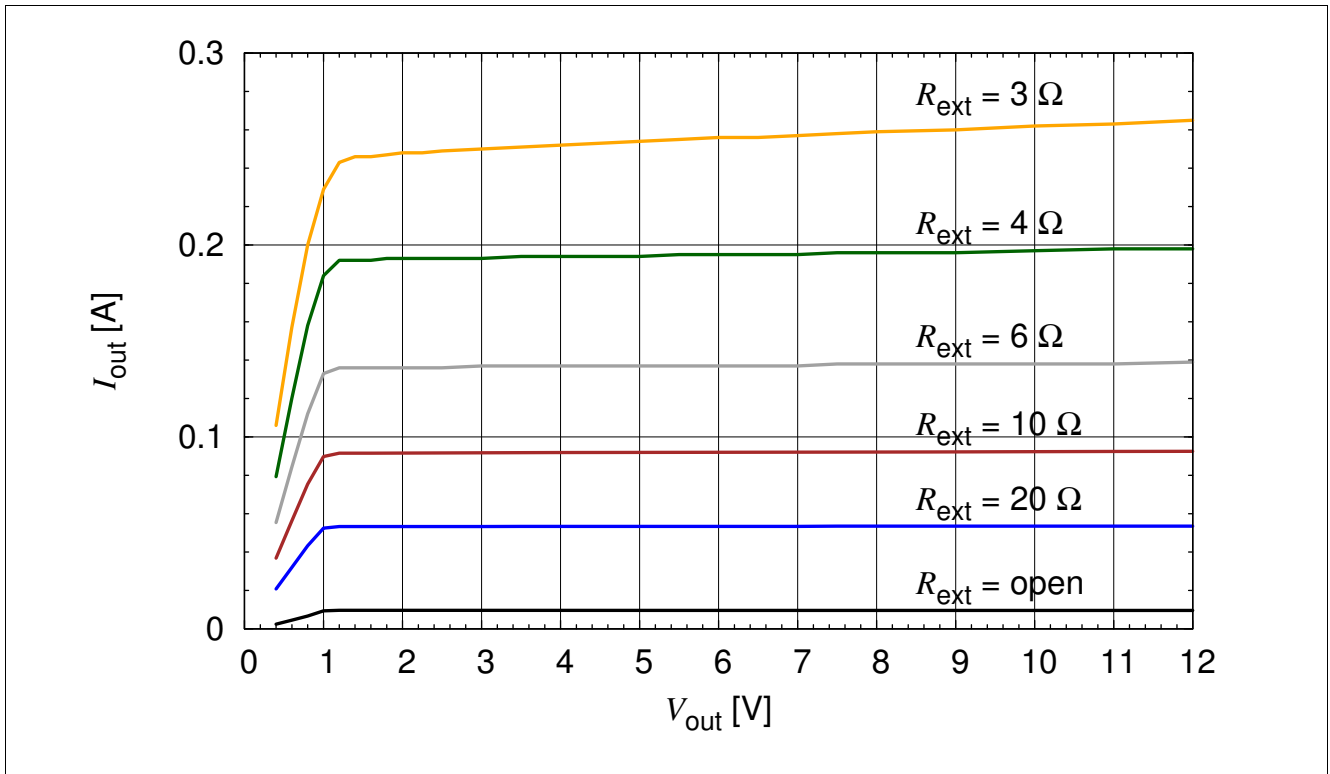

Figure 3-14 BCR321U: Output Current versus  $V_{out}$   $I_{out} = f(V_{out})$ ,  $V_{EN} = 3.3$  V,  $R_{ext} =$  Parameter

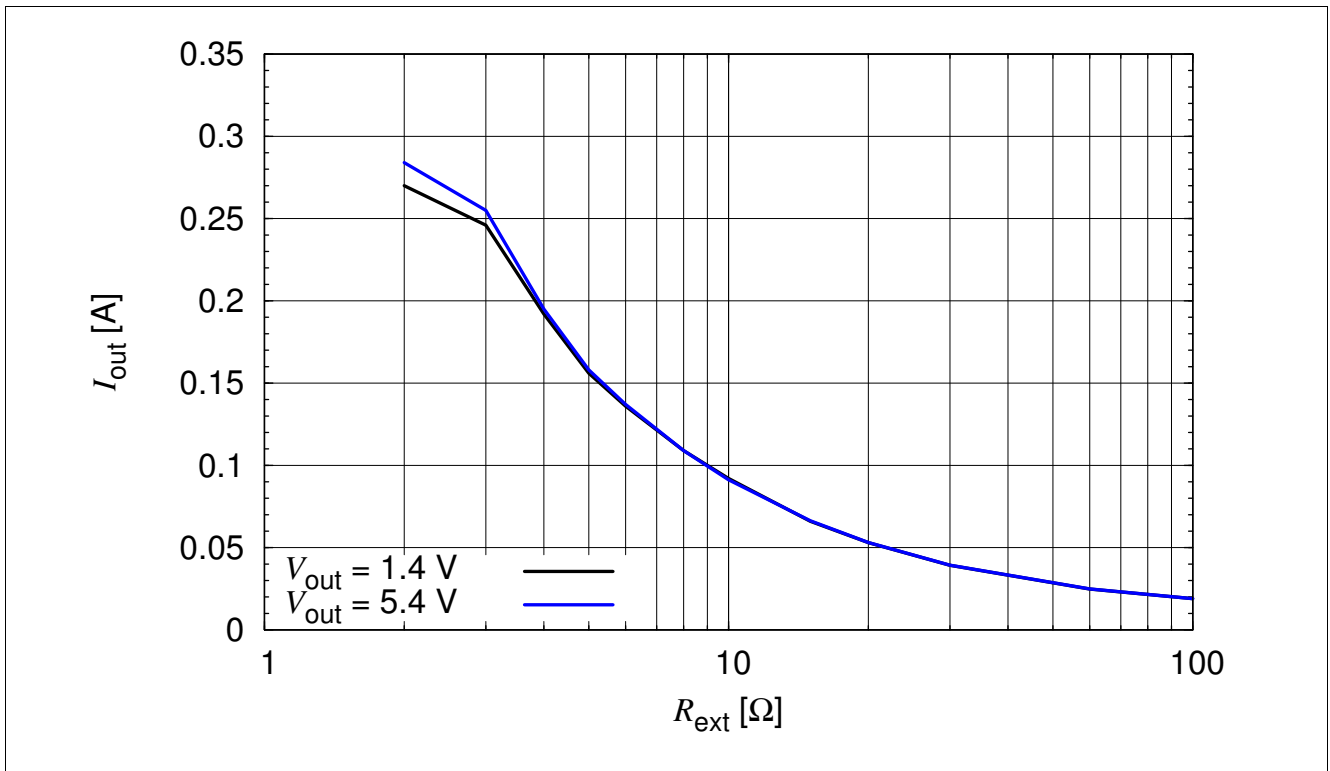

Figure 3-15 BCR321U: Output Current versus  $R_{ext}$   $I_{out} = f(R_{ext})$ ,  $V_{EN} = 3.3$  V,  $V_{out} =$  Parameter

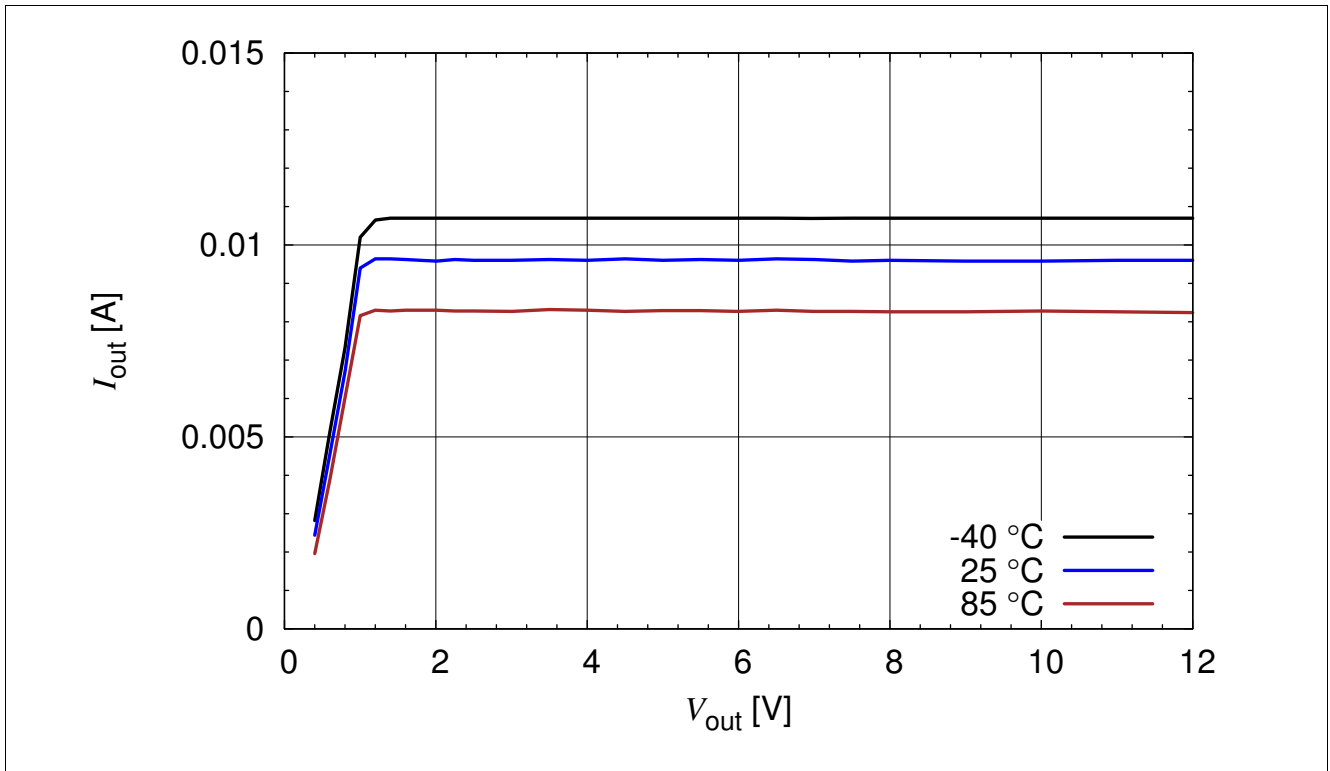

Figure 3-16 BCR321U: Output Current versus  $V_{out}$   $I_{out} = f(V_{out})$ ,  $V_{EN} = 3.3$  V,  $R_{ext} = open$ ,  $T_A = Parameter$

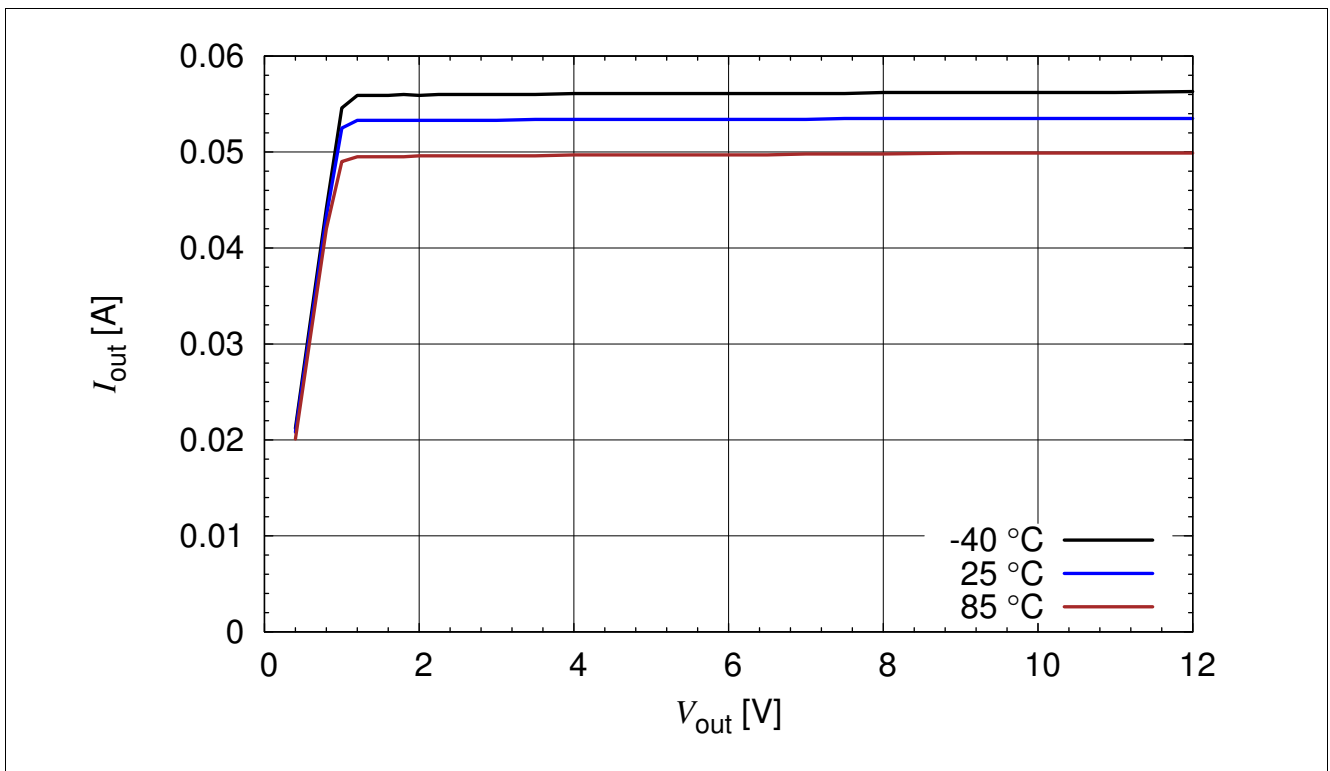

Figure 3-17 BCR321U: Output Current versus  $V_{out}$   $I_{out} = f(V_{out})$ ,  $V_{EN} = 3.3$  V,  $R_{ext} = 20 \Omega$ ,  $T_A = Parameter$

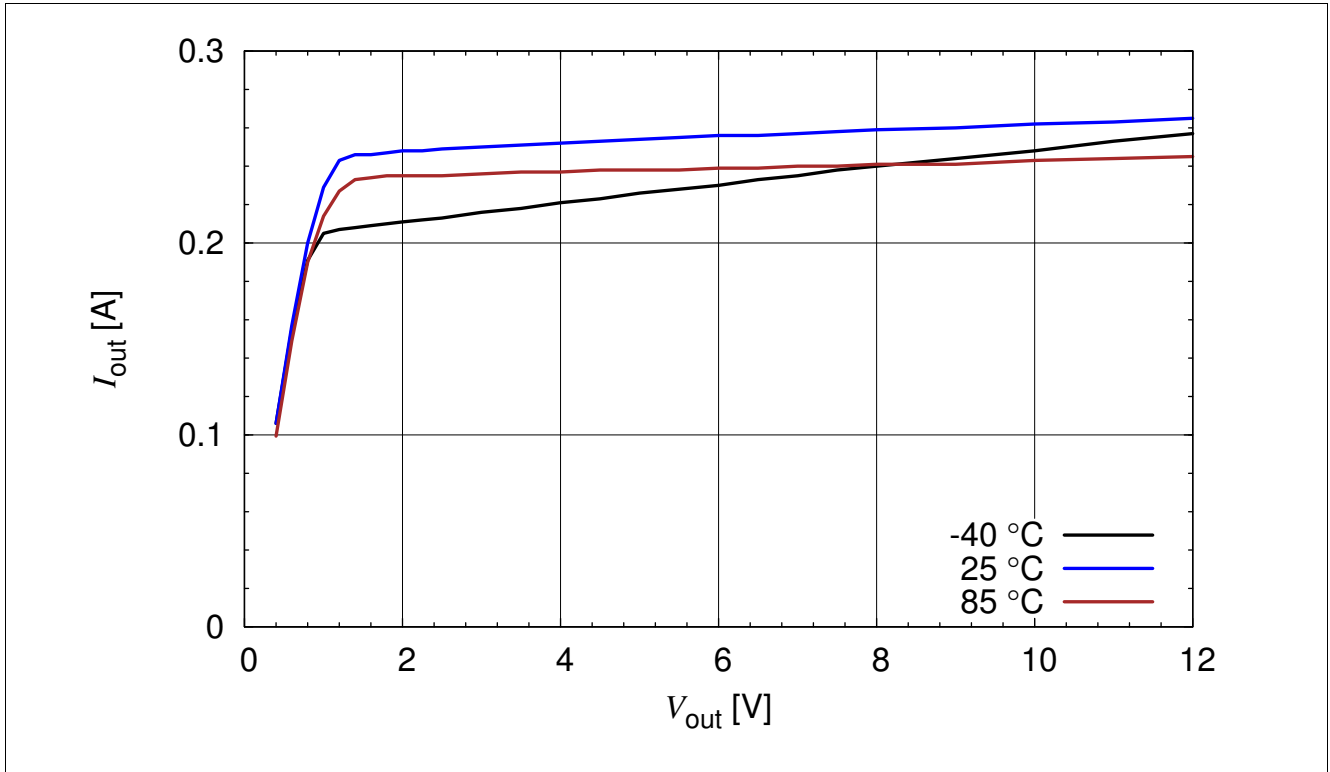

Figure 3-18 BCR321U: Output Current versus  $V_{out}$   $I_{out} = f(V_{out})$ ,  $V_{EN} = 3.3$  V,  $R_{ext} = 3 \Omega$ ,  $T_A =$  Parameter

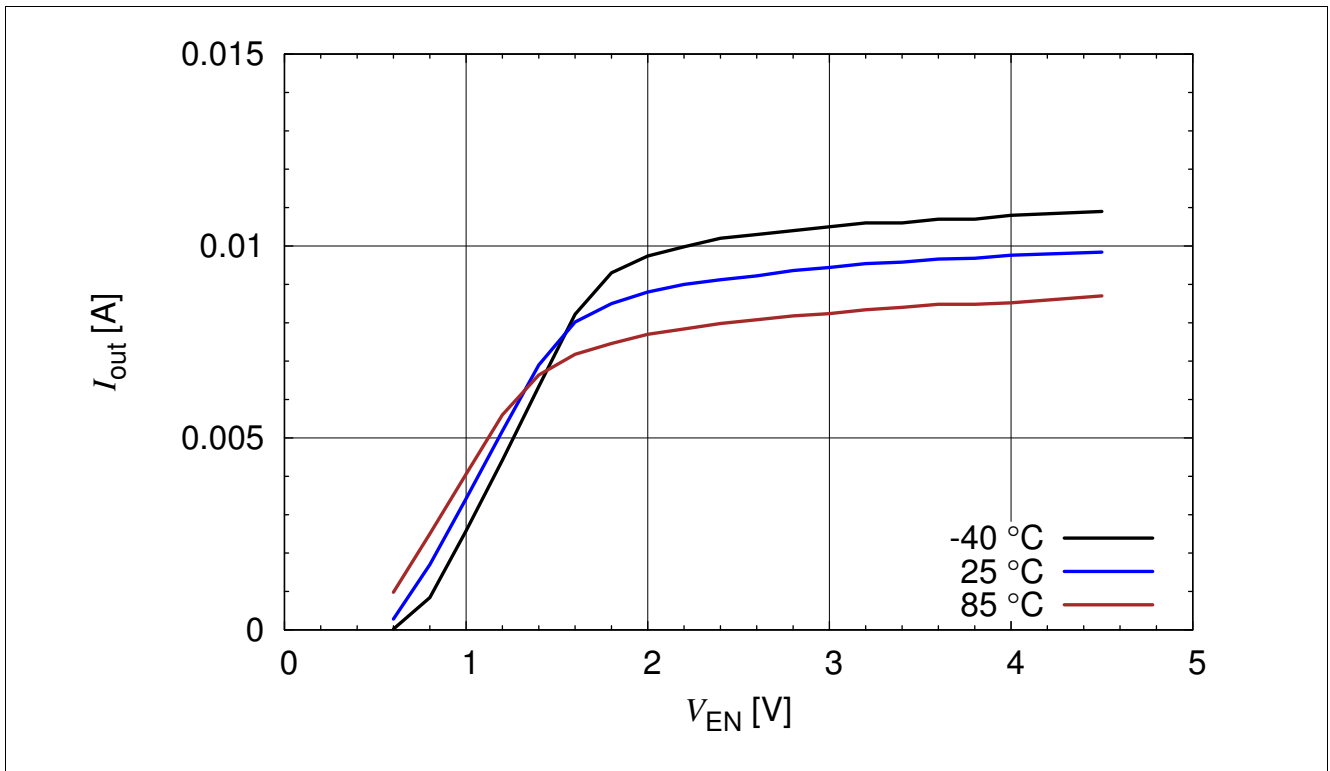

Figure 3-19 BCR321U: Output Current versus  $V_{EN}$   $I_{out} = f(V_{EN})$ ,  $V_{out} = 2$  V,  $R_{ext} =$  open,  $T_A =$  Parameter

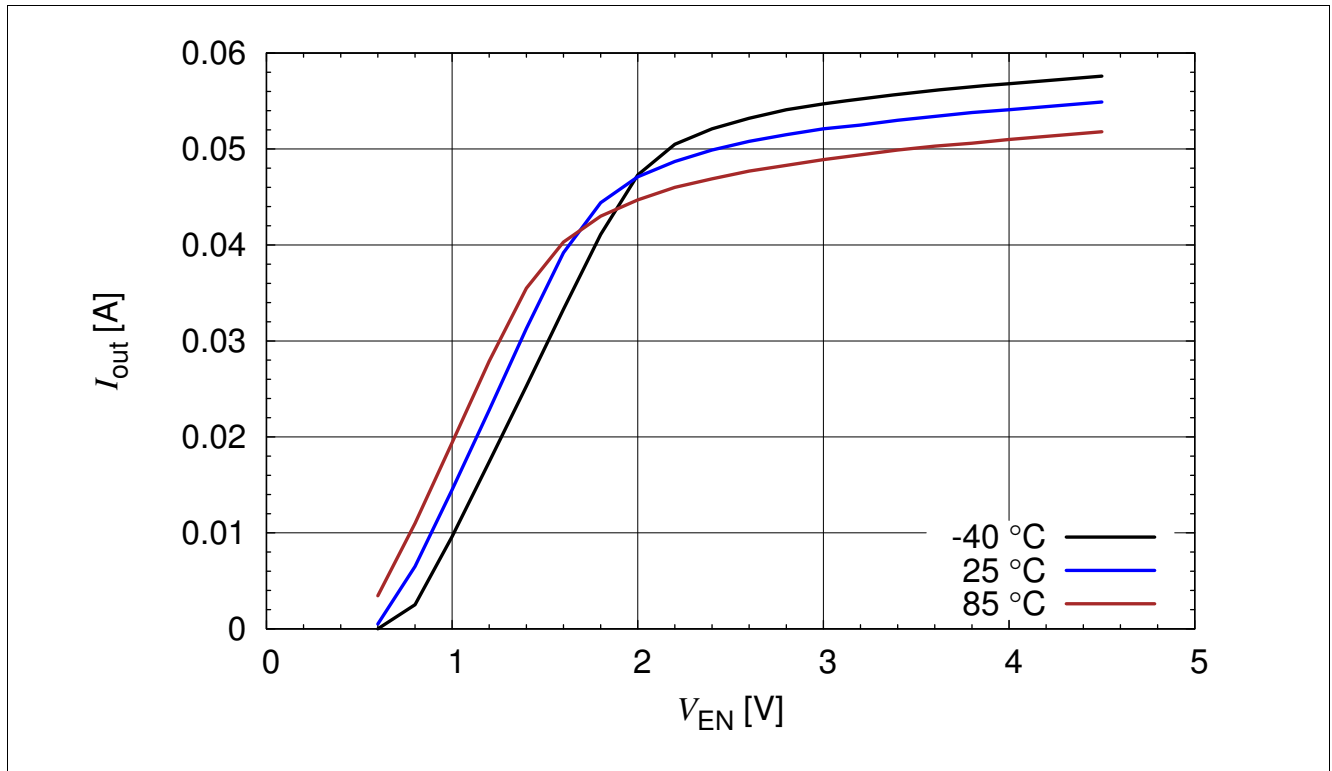

Figure 3-20 BCR321U: Output Current versus  $V_{EN}$   $I_{out} = f(V_{EN})$ ,  $V_{out} = 2\text{ V}$ ,  $R_{ext} = 20\ \Omega$ ,  $T_A = \text{Parameter}$

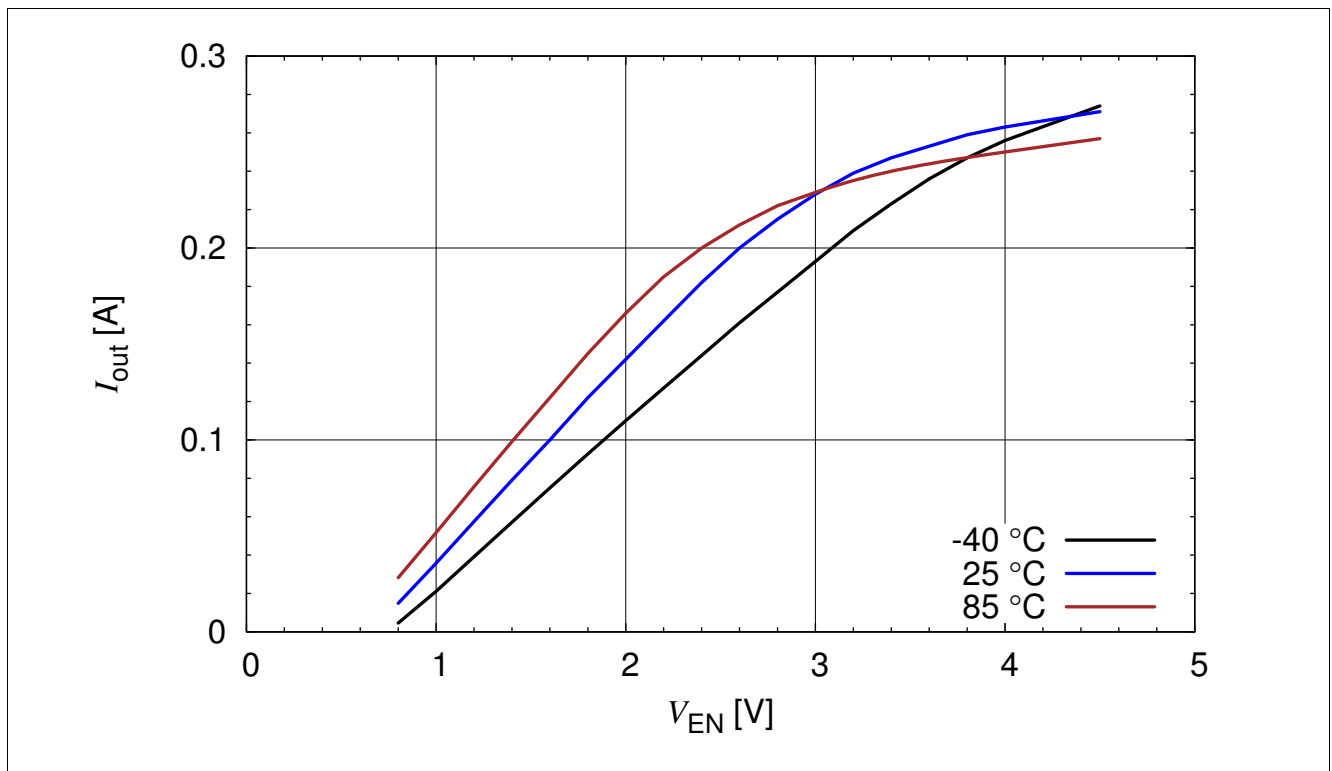

Figure 3-21 BCR321U: Output Current versus  $V_{EN}$   $I_{out} = f(V_{EN})$ ,  $V_{out} = 2\text{ V}$ ,  $R_{ext} = 3\ \Omega$ ,  $T_A = \text{Parameter}$

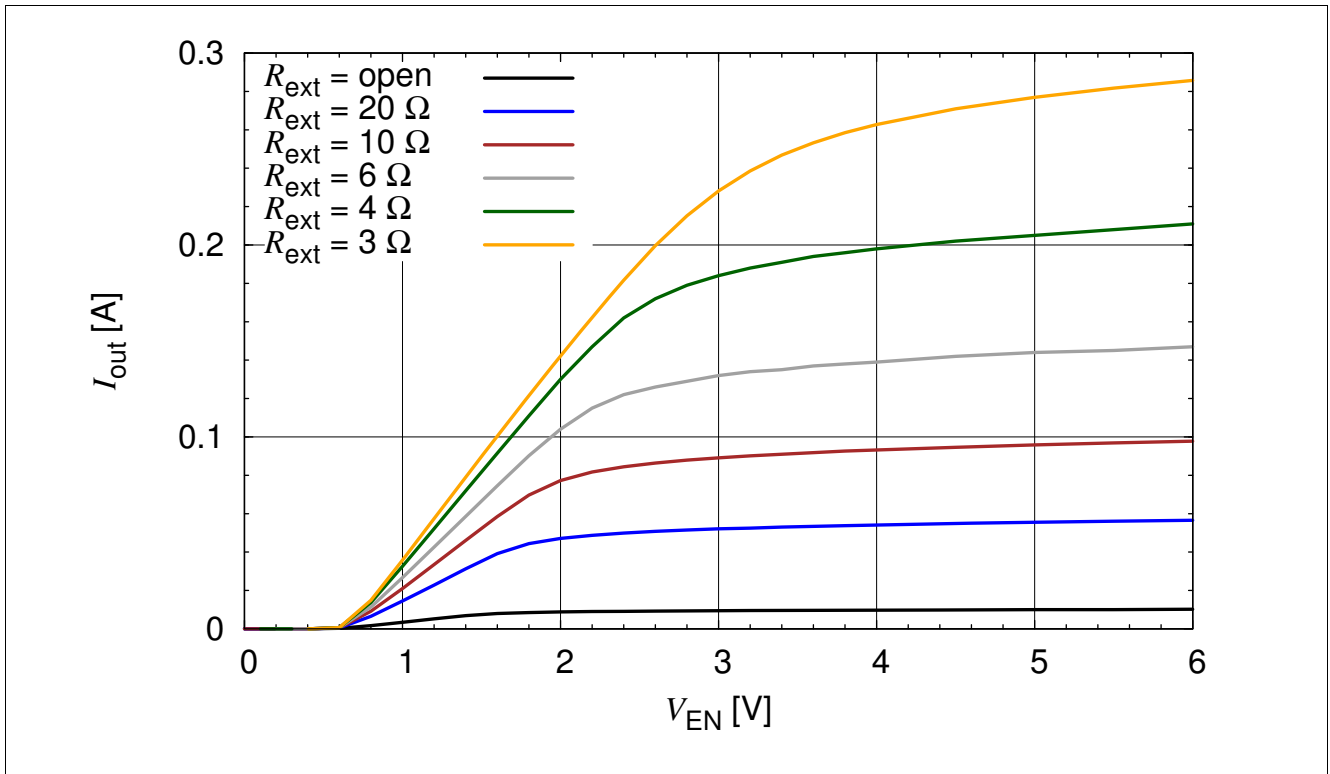

Figure 3-22 BCR321U: Output Current versus  $V_{EN}$   $I_{out} = f(V_{EN})$ ,  $V_{out} = 2\text{ V}$ ,  $R_{ext} = \text{Parameter}$

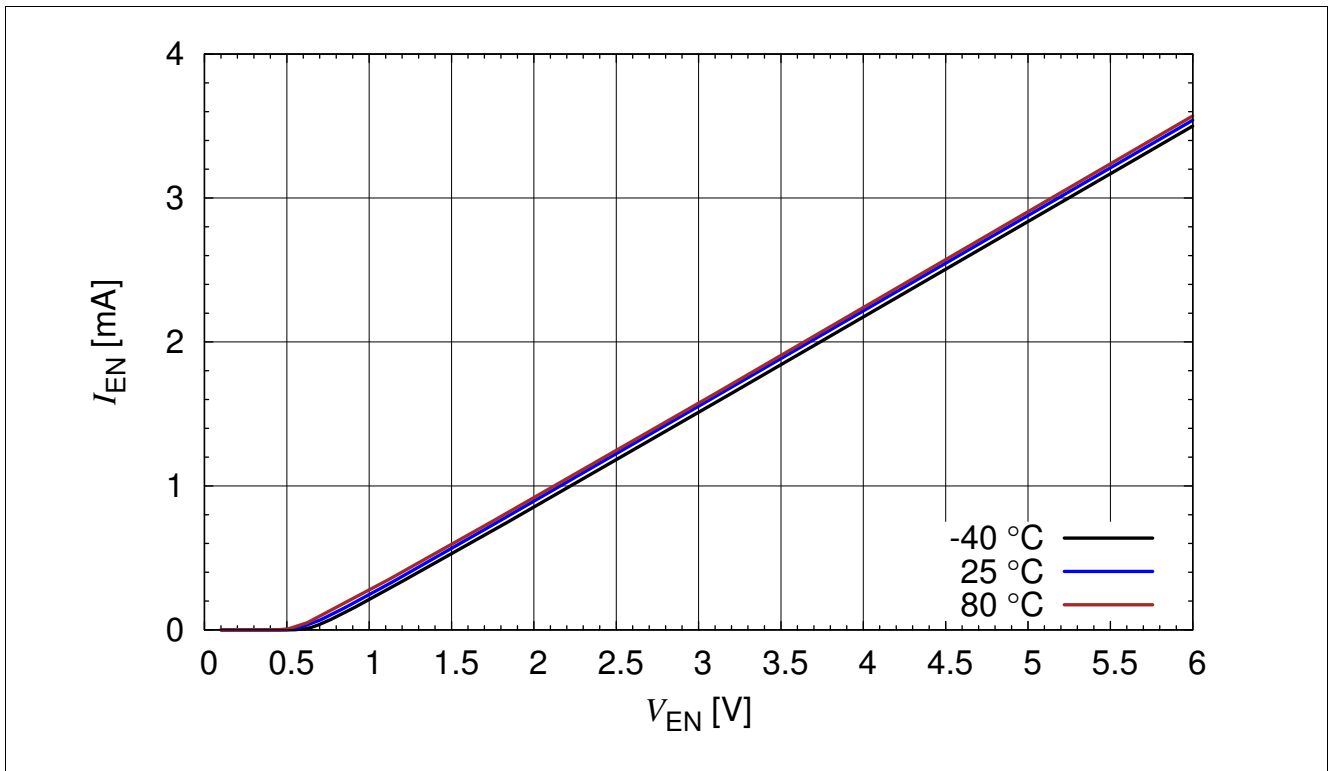

Figure 3-23 BCR321U: Enable Current versus  $V_{EN}$   $I_{EN} = f(V_{EN})$ ,  $R_{ext} = \text{open}$ ,  $I_{out} = 0\text{ A}$ ,  $T_A = \text{Parameter}$

## 4 Application hints

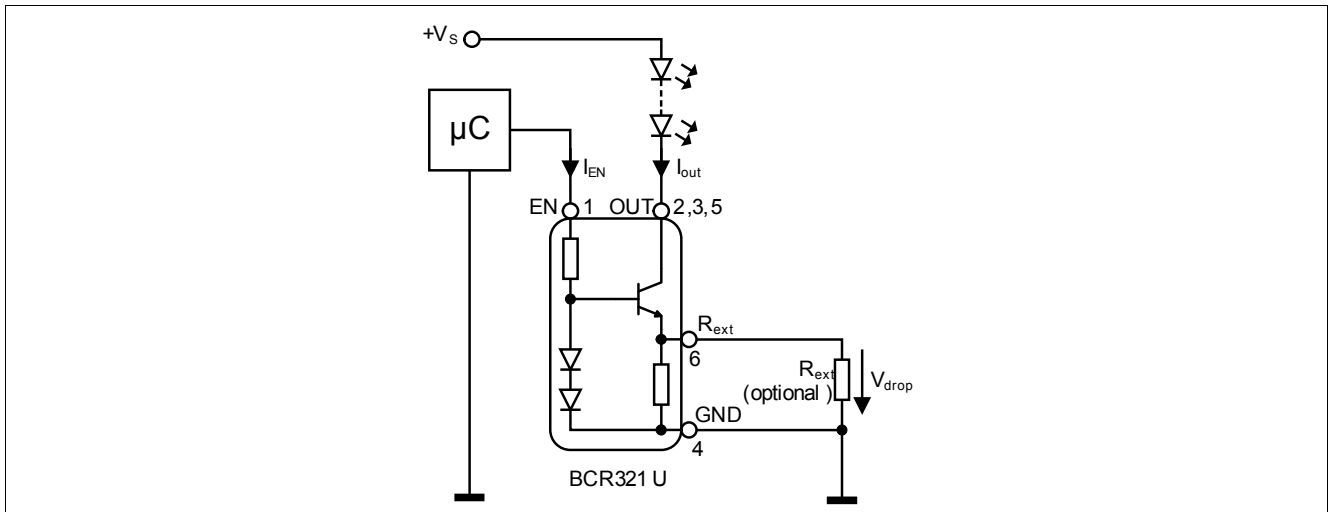

Figure 4-1 Application Circuit: Enabling / PWM by Micro Controller

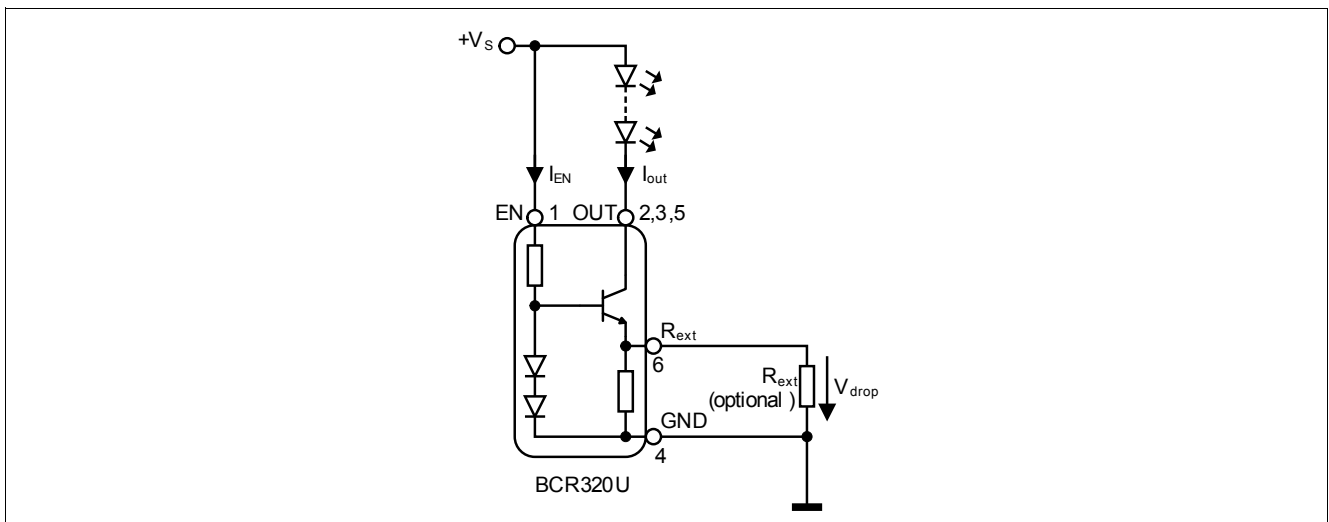

Figure 4-2 Application Circuit: Enabling by Connecting to  $V_S$

### Application hints

BCR320U / BCR321U serve as an easy to use constant current sources for LEDs. In stand alone application an external resistor can be connected to adjust the current from 10 mA to 250 mA.  $R_{ext}$  can be determined by using [Figure 3-5](#) or [Figure 3-15](#). Connecting a low tolerance resistor  $R_{ext}$  will improve the overall accuracy of the current sense resistance formed by the parallel connection of  $R_{int}$  and  $R_{ext}$  leading to an improved current accuracy. Please take into account that the resulting output currents will be slightly lower due to the self heating of the component and the negative thermal coefficient.

Please visit our web site [www.infineon.com/lowcostleddriver](http://www.infineon.com/lowcostleddriver) for application notes and for up-to-date application information.

## 5 Package

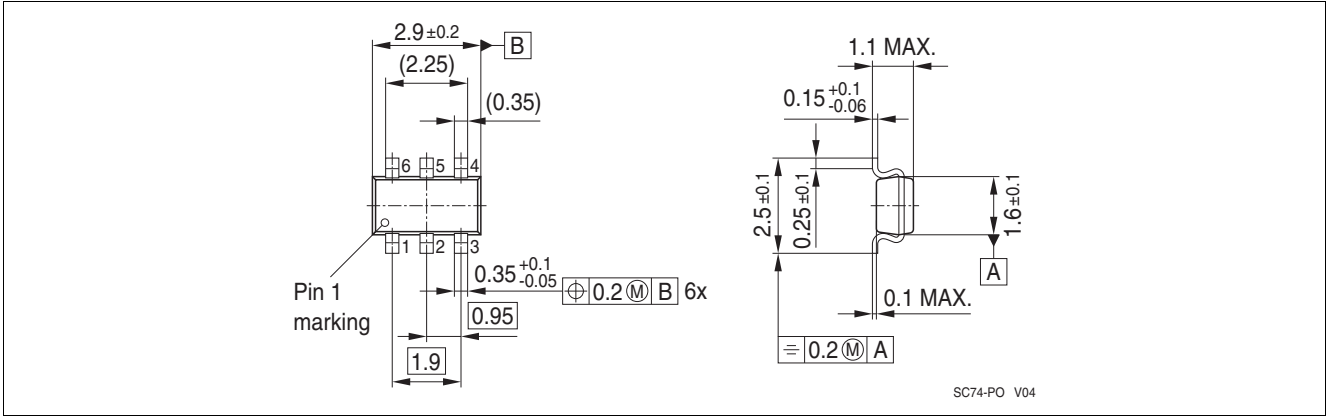

Figure 5-1 Package Outline for SC74 (dimensions in mm)

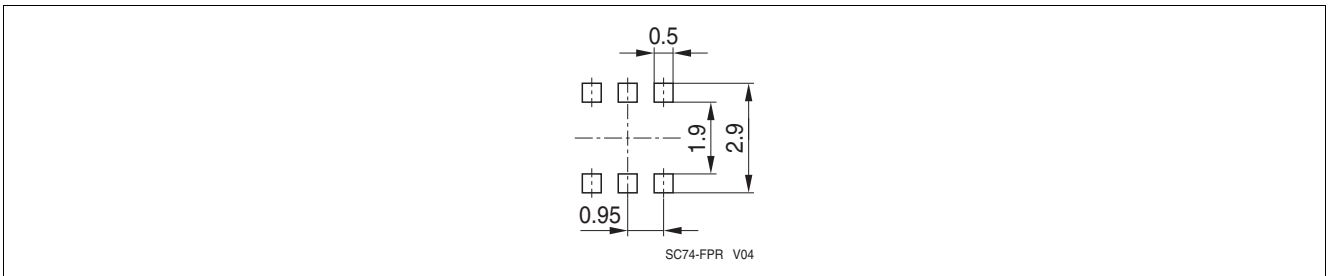

Figure 5-2 Package Footprint for SC74 (dimensions in mm)

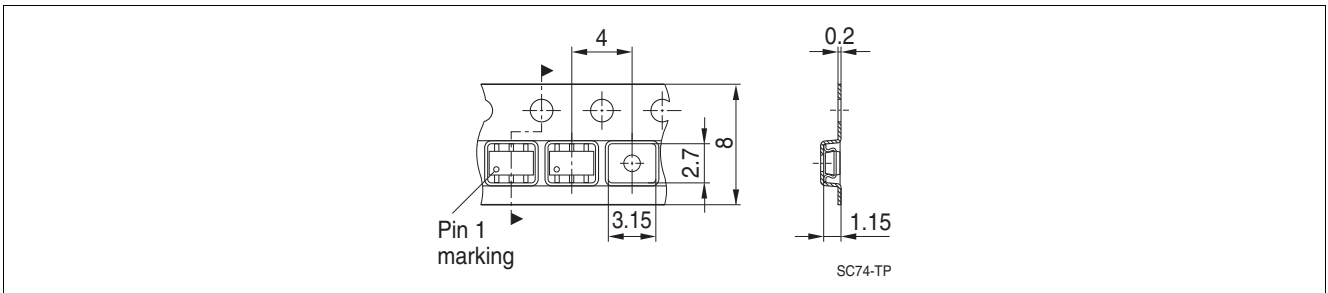

Figure 5-3 Tape and Reel Information for SC74 (dimensions in mm)



## Terminology

|                          |  |
|--------------------------|--|
| $\Delta I_{out}/I_{out}$ | Output current change                          |
| $h_{FE}$                 | DC current gain                                |
| $I_{EN}$                 | Enable current                                 |
| $I_{out}$                | Output current                                 |
| $I_R$                    | Reverse current                                |
| LED                      | Light Emitting Diode                           |
| PCB                      | Printed Circuit Board                          |
| $P_{tot}$                | Total power dissipation                        |
| PWM                      | Pulse Width Modulation                         |
| $R_B$                    | Bias resistor                                  |
| $R_{ext}$                | External resistor                              |
| $R_{int}$                | Internal resistor                              |
| RoHs                     | Restriction of Hazardous Substance directive   |
| $R_{thJS}$               | Thermal resistance junction to soldering point |
| $T_A$                    | Ambient temperature                            |
| $T_J$                    | Junction temperature                           |
| $T_S$                    | Soldering point temperature                    |
| $T_{stg}$                | Storage temperature                            |
| $V_{BR(CEO)}$            | Collector-emitter breakdown voltage            |
| $V_{BR}$                 | Breakdown voltage                              |
| $V_{drop}$               | Voltage drop                                   |
| $V_{EN}$                 | Enable voltage                                 |
| $V_{out}$                | Output voltage                                 |
| $V_R$                    | Reverse voltage                                |
| $V_S$                    | Supply voltage                                 |
| $V_{Smin}$               | Lowest sufficient supply voltage overhead      |

[www.infineon.com](http://www.infineon.com)

Published by Infineon Technologies AG

Компания «Океан Электроники» предлагает заключение долгосрочных отношений при поставках импортных электронных компонентов на взаимовыгодных условиях!

Наши преимущества:

- Поставка оригинальных импортных электронных компонентов напрямую с производств Америки, Европы и Азии, а так же с крупнейших складов мира;
- Широкая линейка поставок активных и пассивных импортных электронных компонентов (более 30 млн. наименований);
- Поставка сложных, дефицитных, либо снятых с производства позиций;
- Оперативные сроки поставки под заказ (от 5 рабочих дней);
- Экспресс доставка в любую точку России;
- Помощь Конструкторского Отдела и консультации квалифицированных инженеров;
- Техническая поддержка проекта, помощь в подборе аналогов, поставка прототипов;
- Поставка электронных компонентов под контролем ВП;
- Система менеджмента качества сертифицирована по Международному стандарту ISO 9001;
- При необходимости вся продукция военного и аэрокосмического назначения проходит испытания и сертификацию в лаборатории (по согласованию с заказчиком);
- Поставка специализированных компонентов военного и аэрокосмического уровня качества (Xilinx, Altera, Analog Devices, Intersil, Interpoint, Microsemi, Actel, Aeroflex, Peregrine, VPT, Syfer, Eurofarad, Texas Instruments, MS Kennedy, Miteq, Cobham, E2V, MA-COM, Hittite, Mini-Circuits, General Dynamics и др.);

Компания «Океан Электроники» является официальным дистрибьютором и эксклюзивным представителем в России одного из крупнейших производителей разъемов военного и аэрокосмического назначения «JONHON», а так же официальным дистрибьютором и эксклюзивным представителем в России производителя высокотехнологичных и надежных решений для передачи СВЧ сигналов «FORSTAR».



## JONHON

«JONHON» (основан в 1970 г.)

Разъемы специального, военного и аэрокосмического назначения:

(Применяются в военной, авиационной, аэрокосмической, морской, железнодорожной, горно- и нефтедобывающей отраслях промышленности)

«FORSTAR» (основан в 1998 г.)

ВЧ соединители, коаксиальные кабели, кабельные сборки и микроволновые компоненты:

(Применяются в телекоммуникациях гражданского и специального назначения, в средствах связи, РЛС, а так же военной, авиационной и аэрокосмической отраслях промышленности).



Телефон: 8 (812) 309-75-97 (многоканальный)

Факс: 8 (812) 320-03-32

Электронная почта: [ocean@oceanchips.ru](mailto:ocean@oceanchips.ru)

Web: <http://oceanchips.ru/>

Адрес: 198099, г. Санкт-Петербург, ул. Калинина, д. 2, корп. 4, лит. А