

High Speed Optocoupler, 1 MBd, Phtodiode with Transistor Output



DESCRIPTION

The 6N135 and 6N136 are optocouplers with a GaAlAs infrared emitting diode, optically coupled with an integrated photo detector which consists of a photo diode and a high-speed transistor in a DIP-8 plastic package. Signals can be transmitted between two electrically separated circuits up to frequencies of 2.0 MHz. The potential difference between the circuits to be coupled should not exceed the maximum permissible reference voltages.

FEATURES

- Isolation test voltages: 5300 V_{RMS}
- TTL compatible
- High bit rates: 1.0 Mbit/s
- High common-mode interference immunity
- Bandwidth 2.0 MHz
- Open-collector output
- External base wiring possible
- Lead (Pb)-free component
- Component in accordance to RoHS 2002/95/EC and WEEE 2002/96/EC



RoHS COMPLIANT

AGENCY APPROVALS

- UL1577, file no. E52744 system code H or J, double protection
- DIN EN 60747-5-5 available with option 1
- CSA 93751

ORDER INFORMATION	
PART	REMARKS
6N135	CTR ≥ 7 %, DIP-8
6N136	CTR ≥ 19 %, DIP-8
6N135-X007	CTR ≥ 7 %, SMD-8 (option 7)
6N136-X006	CTR ≥ 19 %, DIP-8 400 mil (option 6)
6N136-X007	CTR ≥ 19 %, SMD-8 (option 7)
6N136-X009	CTR ≥ 19 %, SMD-8 (option 9)

Note
For additional information on the available options refer to option information.

ABSOLUTE MAXIMUM RATINGS (1)				
PARAMETER	TEST CONDITION	SYMBOL	VALUE	UNIT
INPUT				
Reverse voltage		V _R	5.0	V
Forward current		I _F	25	mA
Peak forward current	t = 1.0 ms, duty cycle 50 %	I _{FSM}	50	mA
Maximum surge forward current	t ≤ 1.0 μs, 300 pulses/s		1.0	A
Thermal resistance		R _{th}	700	K/W
Power dissipation	T _{amb} = 70 °C	P _{diss}	45	mW
OUTPUT				
Supply voltage		V _S	- 0.5 to 15	V
Output voltage		V _O	- 0.5 to 15	V
Emitter base voltage		V _{EBO}	5.0	V
Output current		I _O	8.0	mA
Maximum Output current			16	mA
Base current		I _B	5.0	mA
Thermal resistance			300	K/W
Power dissipation	T _{amb} = 70 °C	P _{diss}	100	mW



ABSOLUTE MAXIMUM RATINGS ⁽¹⁾				
PARAMETER	TEST CONDITION	SYMBOL	VALUE	UNIT
COUPLER				
Isolation test voltage (between emitter and detector climate per DIN 50014 part 2, Nov. 74)	t = 1.0 s	V _{ISO}	5300	V _{RMS}
Pollution degree (DIN VDE 0109)			2.0	
Isolation resistance	V _{IO} = 500 V, T _{amb} = 25 °C	R _{IO}	≥ 10 ¹²	Ω
	V _{IO} = 500 V, T _{amb} = 100 °C	R _{IO}	≥ 10 ¹¹	Ω
Storage temperature range		T _{stg}	- 55 to + 125	°C
Ambient temperature range		T _{amb}	- 55 to + 100	°C
Soldering temperature ⁽²⁾	max. ≤ 10 s, dip soldering ≥ 0.5 mm from case bottom	T _{sld}	260	°C

Notes

- ⁽¹⁾ T_{amb} = 25 °C, unless otherwise specified. Stresses in excess of the absolute maximum ratings can cause permanent damage to the device. Functional operation of the device is not implied at these or any other conditions in excess of those given in the operational sections of this document. Exposure to absolute maximum ratings for extended periods of the time can adversely affect reliability.
- ⁽²⁾ Refer to reflow profile for soldering conditions for surface mounted devices (SMD). Refer to wave profile for soldering conditions for through hole devices (DIP).

ELECTRICAL CHARACTERISTICS ⁽¹⁾							
PARAMETER	TEST CONDITION	PART	SYMBOL	MIN.	TYP.	MAX.	UNIT
INPUT							
Forward voltage	I _F = 1.6 mA		V _F		1.6	1.9	V
Breakdown voltage	I _R = 10 μA		V _{BR}	5.0			V
Reverse current	V _R = 5.0 V		I _R		0.5	10	μA
Capacitance	V _R = 0 V, f = 1.0 MHz		C _O		125		pF
Temperature coefficient, forward voltage	I _F = 1.6 mA		ΔV _F /ΔT _A		- 1.7		mV/°C
OUTPUT							
Logic low supply current	I _F = 1.6 mA, V _O = open, V _{CC} = 15 V		I _{CCL}		150		μA
Logic high supply current	I _F = 0 mA, V _O = open, V _{CC} = 15 V		I _{CCH}		0.01	1	μA
Output voltage, output low	I _F = 16 mA, I _O = 1.1 mA, V _{CC} = 4.5 V	6N135	V _{OL}		0.1	0.4	V
	I _F = 16 mA, I _O = 2.4 mA, V _{CC} = 4.5 V	6N136	V _{OL}		0.1	0.4	V
Output current, output high	I _F = 0 mA, V _O = V _{CC} = 5.5 V		I _{OH}		3.0	500	nA
	I _F = 0 mA, V _O = V _{CC} = 15 V		I _{OH}		0.01	1	μA
COUPLER							
Capacitance (input to output)	f = 1.0 MHz		C _{IO}		0.6		pF

Note

T_{amb} = 25 °C, unless otherwise specified. Minimum and maximum values are testing requirements. Typical values are characteristics of the device and are the result of engineering evaluation. Typical values are for information only and are not part of the testing requirements.

CURRENT TRANSFER RATIO							
PARAMETER	TEST CONDITION	PART	SYMBOL	MIN.	TYP.	MAX.	UNIT
Current transfer ratio	$I_F = 16 \text{ mA}$, $V_O = 0.4 \text{ V}$, $V_{CC} = 4.5 \text{ V}$	6N135	CTR	7	16		%
		6N136	CTR	19	35		%
	$I_F = 16 \text{ mA}$, $V_O = 0.5 \text{ V}$, $V_{CC} = 4.5 \text{ V}$	6N135	CTR	5			%
		6N136	CTR	15			%

SWITCHING CHARACTERISTICS							
PARAMETER	TEST CONDITION	PART	SYMBOL	MIN.	TYP.	MAX.	UNIT
High to low	$I_F = 16 \text{ mA}$, $V_{CC} = 5.0 \text{ V}$, $R_L = 4.1 \text{ k}\Omega$	6N135	t_{PHL}		0.3	1.5	μs
	$I_F = 16 \text{ mA}$, $V_{CC} = 5.0 \text{ V}$, $R_L = 1.9 \text{ k}\Omega$	6N136	t_{PHL}		0.2	0.8	μs
Low to high	$I_F = 16 \text{ mA}$, $V_{CC} = 5.0 \text{ V}$, $R_L = 4.1 \text{ k}\Omega$	6N135	t_{PLH}		0.3	1.5	μs
	$I_F = 16 \text{ mA}$, $V_{CC} = 5.0 \text{ V}$, $R_L = 1.9 \text{ k}\Omega$	6N136	t_{PLH}		0.2	0.8	μs

COMMON MODE TRANSIENT IMMUNITY							
PARAMETER	TEST CONDITION	PART	SYMBOL	MIN.	TYP.	MAX.	UNIT
High	$I_F = 0 \text{ mA}$, $V_{CM} = 10 \text{ V}_{P-P}$, $V_{CC} = 5.0 \text{ V}$, $R_L = 4.1 \text{ k}\Omega$	6N135	$ CM_H $		1000		$\text{V}/\mu\text{s}$
	$I_F = 0 \text{ mA}$, $V_{CM} = 10 \text{ V}_{P-P}$, $V_{CC} = 5.0 \text{ V}$, $R_L = 1.9 \text{ k}\Omega$	6N136	$ CM_H $		1000		$\text{V}/\mu\text{s}$
Low	$I_F = 16 \text{ mA}$, $V_{CM} = 10 \text{ V}_{P-P}$, $V_{CC} = 5.0 \text{ V}$, $R_L = 4.1 \text{ k}\Omega$	6N135	$ CM_L $		1000		$\text{V}/\mu\text{s}$
	$I_F = 16 \text{ mA}$, $V_{CM} = 10 \text{ V}_{P-P}$, $V_{CC} = 5.0 \text{ V}$, $R_L = 1.9 \text{ k}\Omega$	6N136	$ CM_L $		1000		$\text{V}/\mu\text{s}$

SAFETY AND INSULATION RATINGS							
PARAMETER	TEST CONDITION	SYMBOL	MIN.	TYP.	MAX.	UNIT	
Climatic classification (according to IEC 68 part 1)				55/100/21			
Comparative tracking index		CTI	175		399		
V_{IOTM}			8000				V
V_{IORM}			890				V
P_{SO}					500		mW
I_{SI}					300		mA
T_{SI}					175		$^{\circ}\text{C}$
Creepage distance	standard DIP-8		7				mm
Clearance distance	standard DIP-8		7				mm
Creepage distance	400 mil DIP-8		8				mm
Clearance distance	400 mil DIP-8		8				mm

Note

As per IEC 60747-5-2, § 7.4.3.8.1, this optocoupler is suitable for "safe electrical insulation" only within the safety ratings. Compliance with the safety ratings shall be ensured by means of protective circuits.

TYPICAL CHARACTERISTICS
 $T_{amb} = 25\text{ }^{\circ}\text{C}$, unless otherwise specified

Fig. 1 - LED Forward Current vs. Forward Voltage



Fig. 4 - Output Current vs. Output Voltage

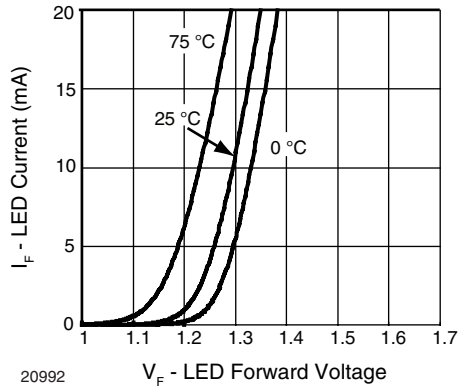

Fig. 2 - Permissible Forward LED Current vs. Temperature



Fig. 5 - Output Current vs. Temperature

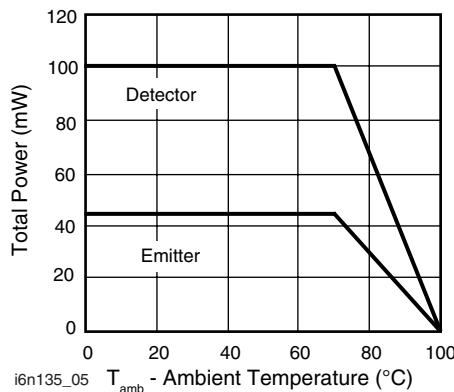

Fig. 3 - Permissible Power Dissipation vs. Temperature



Fig. 6 - Propagation Delay vs. Ambient Temperature



Fig. 7 - Propagation Delay vs. Ambient Temperature



Fig. 9 - Small Signal Current Transfer Ratio vs. Quiescent Input Current



Fig. 8 - Logic High Output Current vs. Temperature



Fig. 10 - Switching Times





i6n135_02



Fig. 11 - Common-Mode Interference Immunity

PACKAGE DIMENSIONS in inches (millimeters)



i178006



Option 6

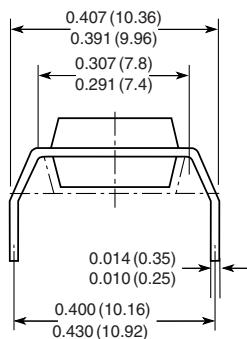

Option 7

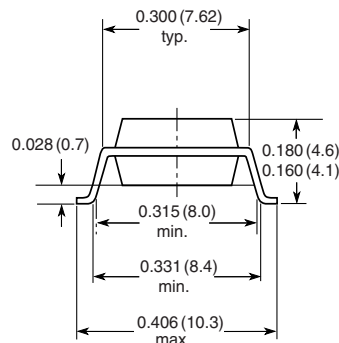

Option 9

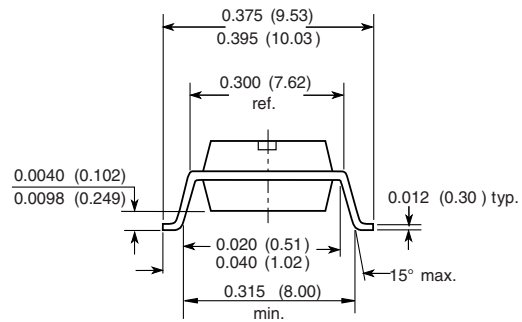

18450

OZONE DEPLETING SUBSTANCES POLICY STATEMENT

It is the policy of Vishay Semiconductor GmbH to

1. Meet all present and future national and international statutory requirements.
2. Regularly and continuously improve the performance of our products, processes, distribution and operating systems with respect to their impact on the health and safety of our employees and the public, as well as their impact on the environment.

It is particular concern to control or eliminate releases of those substances into the atmosphere which are known as ozone depleting substances (ODSs).

The Montreal Protocol (1987) and its London Amendments (1990) intend to severely restrict the use of ODSs and forbid their use within the next ten years. Various national and international initiatives are pressing for an earlier ban on these substances.

Vishay Semiconductor GmbH has been able to use its policy of continuous improvements to eliminate the use of ODSs listed in the following documents.

1. Annex A, B and list of transitional substances of the Montreal Protocol and the London Amendments respectively.
2. Class I and II ozone depleting substances in the Clean Air Act Amendments of 1990 by the Environmental Protection Agency (EPA) in the USA.
3. Council Decision 88/540/EEC and 91/690/EEC Annex A, B and C (transitional substances) respectively.

Vishay Semiconductor GmbH can certify that our semiconductors are not manufactured with ozone depleting substances and do not contain such substances.

We reserve the right to make changes to improve technical design
and may do so without further notice.

Parameters can vary in different applications. All operating parameters must be validated for each customer application by the customer. Should the buyer use Vishay Semiconductors products for any unintended or unauthorized application, the buyer shall indemnify Vishay Semiconductors against all claims, costs, damages, and expenses, arising out of, directly or indirectly, any claim of personal damage, injury or death associated with such unintended or unauthorized use.

Vishay Semiconductor GmbH, P.O.B. 3535, D-74025 Heilbronn, Germany



Notice

Specifications of the products displayed herein are subject to change without notice. Vishay Intertechnology, Inc., or anyone on its behalf, assumes no responsibility or liability for any errors or inaccuracies.

Information contained herein is intended to provide a product description only. No license, express or implied, by estoppel or otherwise, to any intellectual property rights is granted by this document. Except as provided in Vishay's terms and conditions of sale for such products, Vishay assumes no liability whatsoever, and disclaims any express or implied warranty, relating to sale and/or use of Vishay products including liability or warranties relating to fitness for a particular purpose, merchantability, or infringement of any patent, copyright, or other intellectual property right.

The products shown herein are not designed for use in medical, life-saving, or life-sustaining applications. Customers using or selling these products for use in such applications do so at their own risk and agree to fully indemnify Vishay for any damages resulting from such improper use or sale.

Компания «Океан Электроники» предлагает заключение долгосрочных отношений при поставках импортных электронных компонентов на взаимовыгодных условиях!

Наши преимущества:

- Поставка оригинальных импортных электронных компонентов напрямую с производств Америки, Европы и Азии, а так же с крупнейших складов мира;
- Широкая линейка поставок активных и пассивных импортных электронных компонентов (более 30 млн. наименований);
- Поставка сложных, дефицитных, либо снятых с производства позиций;
- Оперативные сроки поставки под заказ (от 5 рабочих дней);
- Экспресс доставка в любую точку России;
- Помощь Конструкторского Отдела и консультации квалифицированных инженеров;
- Техническая поддержка проекта, помощь в подборе аналогов, поставка прототипов;
- Поставка электронных компонентов под контролем ВП;
- Система менеджмента качества сертифицирована по Международному стандарту ISO 9001;
- При необходимости вся продукция военного и аэрокосмического назначения проходит испытания и сертификацию в лаборатории (по согласованию с заказчиком);
- Поставка специализированных компонентов военного и аэрокосмического уровня качества (Xilinx, Altera, Analog Devices, Intersil, Interpoint, Microsemi, Actel, Aeroflex, Peregrine, VPT, Syfer, Eurofarad, Texas Instruments, MS Kennedy, Miteq, Cobham, E2V, MA-COM, Hittite, Mini-Circuits, General Dynamics и др.);

Компания «Океан Электроники» является официальным дистрибьютором и эксклюзивным представителем в России одного из крупнейших производителей разъемов военного и аэрокосмического назначения «JONHON», а так же официальным дистрибьютором и эксклюзивным представителем в России производителя высокотехнологичных и надежных решений для передачи СВЧ сигналов «FORSTAR».



JONHON

«JONHON» (основан в 1970 г.)

Разъемы специального, военного и аэрокосмического назначения:

(Применяются в военной, авиационной, аэрокосмической, морской, железнодорожной, горно- и нефтедобывающей отраслях промышленности)

«FORSTAR» (основан в 1998 г.)

ВЧ соединители, коаксиальные кабели, кабельные сборки и микроволновые компоненты:

(Применяются в телекоммуникациях гражданского и специального назначения, в средствах связи, РЛС, а так же военной, авиационной и аэрокосмической отраслях промышленности).



Телефон: 8 (812) 309-75-97 (многоканальный)

Факс: 8 (812) 320-03-32

Электронная почта: ocean@oceanchips.ru

Web: <http://oceanchips.ru/>

Адрес: 198099, г. Санкт-Петербург, ул. Калинина, д. 2, корп. 4, лит. А