



## Features

- Surface mount devices
- High voltage surge capabilities
- Binned and sorted resistance ranges
- Assists in meeting ITU K.20/K.21 specifications
- RoHS compliant\*
- Agency recognition:   

## Applications

Used as a secondary overcurrent protection device in:

- Customer Premise Equipment (CPE)
- Central Office (CO)
- Subscriber Line Interface Cards (SLIC)

# MF-SM013/250 - Telecom PTC Resettable Fuses

## Electrical Characteristics

Model	Max. Operating Voltage	Max. Interrupt Ratings		Hold Current	Initial Resistance		One Hour Post-Trip Resistance	Tripped Power Dissipation
	Volts (V)	Volts (V)	Amps (A)	Amps at 23 °C	Ohms at 23 °C	Ohms at 23 °C	Ohms at 23 °C	Watts at 23 °C
		Max.	Max.	I <sub>H</sub>	Min.	Max.	Max.	Typ.
MF-SM013/250-2	60	250	3.0	0.13	6.5	12.0	20.0	3.3
MF-SM013/250-A-2	60	250	3.0	0.13	6.5	9.0	20.0	3.3
MF-SM013/250-B-2	60	250	3.0	0.13	9.0	12.0	20.0	3.3
MF-SM013/250-C-2	60	250	3.0	0.13	7.0	10.0	20.0	3.3

## Environmental Characteristics

Operating Temperature.....	-45 °C to +85 °C
Maximum Device Surface Temperature in Tripped State .....	125 °C
Passive Aging .....	+85 °C, 1000 hours..... ±2 % typical resistance change
	+60 °C, 1000 hours..... ±3 % typical resistance change
Humidity Aging.....	+85 °C, 85 % R.H. 500 hours ..... ±3 % typical resistance change
Thermal Shock .....	MIL-STD-202F, Method 107G..... ±10 % typical resistance change
	+125 °C to -55 °C, 10 times..... ±15 % typical resistance change
Solvent Resistance.....	MIL-STD-202, Method 215B..... No change
Lead Solderability.....	ANSI/J-STD-002
Flammability .....	IEC 695-2-2 ..... No Flame for 60 secs.
Vibration .....	MIL-STD-883C, Method 2007.1, Condition A ..... No change

## Test Procedures And Requirements For Model MF-SM013/250 Series

Test	Test Conditions	Accept/Reject Criteria
Visual/Mech.....	Verify dimensions and materials.....	Per MF physical description
Resistance.....	In still air @ 23 °C.....	R <sub>min</sub> ≤ R ≤ R <sub>max</sub>
Time to Trip.....	At specified current, V <sub>max</sub> , 23 °C.....	T ≤ max. time to trip (seconds)
Hold Current.....	30 min. at I <sub>hold</sub> .....	No trip
Trip Cycle Life.....	V <sub>max</sub> , I <sub>max</sub> , 100 cycles.....	No arcing or burning
Trip Endurance.....	V <sub>max</sub> , 48 hours.....	No arcing or burning
Solderability.....	MIL-STD-202F, Method 208F.....	95 % min. coverage

UL File Number .....	E 174545S
CSA File Number.....	CA 110338
TUV File Number.....	R2057213

## Thermal Derating Chart - I<sub>hold</sub>/ I<sub>trip</sub> (Amps)

Model	Ambient Operating Temperature								
	-40 °C	-20 °C	0 °C	23 °C	40 °C	50 °C	60 °C	70 °C	85 °C
MF-SM013/250-2	0.21 / 0.42	0.18 / 0.37	0.16 / 0.31	0.13 / 0.26	0.10 / 0.23	0.09 / 0.18	0.08 / 0.15	0.07 / 0.12	0.05 / 0.10
MF-SM013/250-A-2	0.21 / 0.42	0.18 / 0.37	0.16 / 0.31	0.13 / 0.26	0.10 / 0.23	0.09 / 0.18	0.08 / 0.15	0.07 / 0.12	0.05 / 0.10
MF-SM013/250-B-2	0.21 / 0.42	0.18 / 0.37	0.16 / 0.31	0.13 / 0.26	0.10 / 0.23	0.09 / 0.18	0.08 / 0.15	0.07 / 0.12	0.05 / 0.10
MF-SM013/250-C-2	0.21 / 0.42	0.18 / 0.37	0.16 / 0.31	0.13 / 0.26	0.10 / 0.23	0.09 / 0.18	0.08 / 0.15	0.07 / 0.12	0.05 / 0.10

\*RoHS Directive 2002/95/EC Jan. 27, 2003 including annex and RoHS Recast 2011/65/EU June 8, 2011.  
 Specifications are subject to change without notice.  
 Customers should verify actual device performance in their specific applications.

## Additional Features

- Withstands lightning power induction

# MF-SM013/250 - Telecom PTC Resettable Fuses

**BOURNS®**

### Product Dimensions

Model	A Max.	B Max.	C Max.	D Nom.	E Nom.	G Nom.	H Nom.	I Nom.
MF-SM013/250-2	$\frac{9.4}{(0.370)}$	$\frac{3.7}{(0.146)}$	$\frac{7.4}{(0.291)}$	$\frac{0.3}{(0.012)}$	$\frac{3.8}{(0.149)}$	$\frac{9.7}{(0.383)}$	$\frac{4.6}{(0.18)}$	$\frac{1.8}{(0.071)}$
MF-SM013/250-A-2	$\frac{9.4}{(0.370)}$	$\frac{3.7}{(0.146)}$	$\frac{7.4}{(0.291)}$	$\frac{0.3}{(0.012)}$	$\frac{3.8}{(0.149)}$	$\frac{9.7}{(0.383)}$	$\frac{4.6}{(0.18)}$	$\frac{1.8}{(0.071)}$
MF-SM013/250-B-2	$\frac{9.4}{(0.370)}$	$\frac{3.7}{(0.146)}$	$\frac{7.4}{(0.291)}$	$\frac{0.3}{(0.012)}$	$\frac{3.8}{(0.149)}$	$\frac{9.7}{(0.383)}$	$\frac{4.6}{(0.18)}$	$\frac{1.8}{(0.071)}$
MF-SM013/250-C-2	$\frac{9.4}{(0.370)}$	$\frac{3.7}{(0.146)}$	$\frac{7.4}{(0.291)}$	$\frac{0.3}{(0.012)}$	$\frac{3.8}{(0.149)}$	$\frac{9.7}{(0.383)}$	$\frac{4.6}{(0.18)}$	$\frac{1.8}{(0.071)}$

Packaging:  
TAPE & REEL: 1500 pcs. per reel

DIMENSIONS:  $\frac{\text{MM}}{\text{(INCHES)}}$

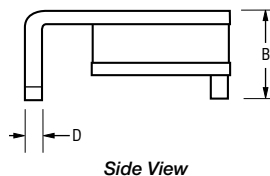
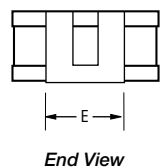
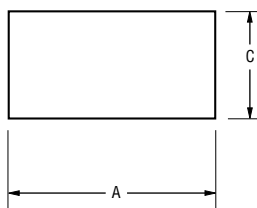

Terminal material:  
Tin-plated brass

### Recommended Pad Layout

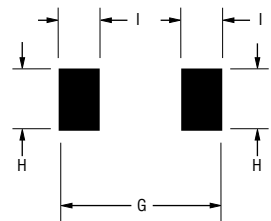

### Solder Reflow Recommendations

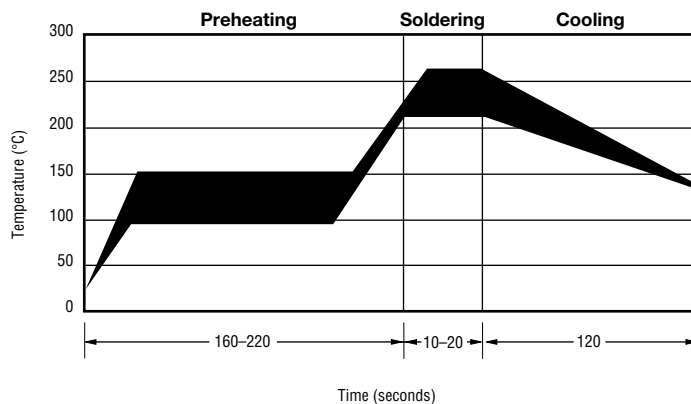

#### Solder reflow

- Recommended reflow methods: IR, vapor phase oven, hot air oven.
- Devices are not designed to be wave soldered to the bottom side of the board.
- Gluing the devices is not recommended.
- Recommended maximum paste thickness is 0.25 mm (.010 inch).
- Devices can be cleaned using standard industry methods and solvents.

#### Note:

- If reflow temperatures exceed the recommended profile, devices may not meet the performance requirements.

#### Rework

- A device should not be reworked.

### Storage Recommendations

The recommended long term storage conditions for Multifuse® Polymer PTC devices are 40 °C maximum and 70 % RH maximum. All devices should remain in the original sealed packaging prior to use. Devices may not conform with data sheet specifications if these storage recommendations are exceeded. Devices stored in this manner have an indefinite shelf life.

# MF-SM013/250 - Telecom PTC Resettable Fuses



## Typical Time to Trip at 23 °C

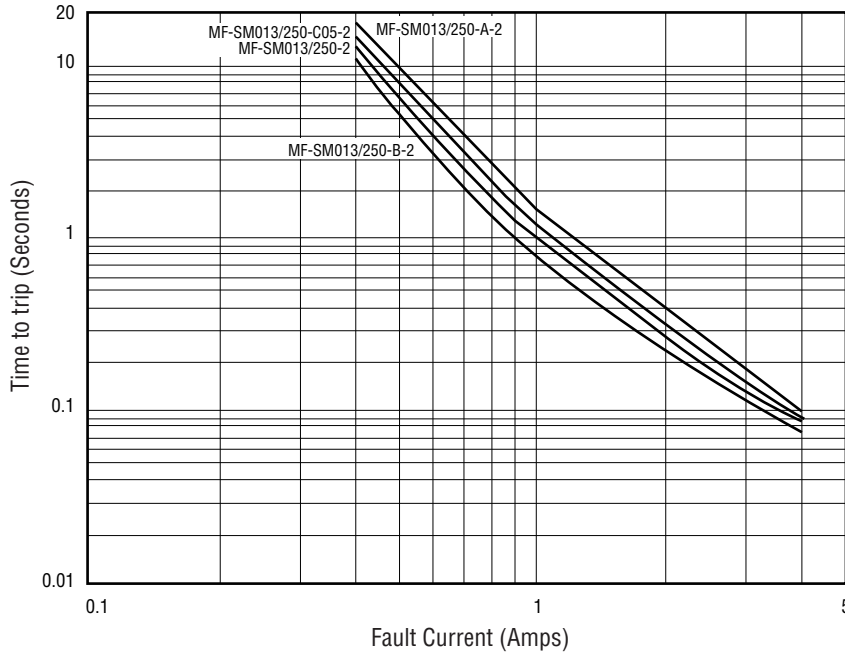

## Typical Part Marking

Represents total content. Layout may vary.

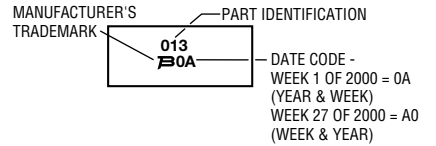

## How to Order

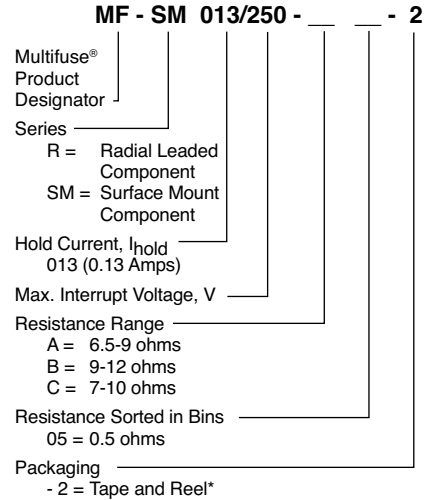

\*Packaged per EIA486-B

NOTE: All parts are also available "binned". All parts within a package will be within 0.5 ohms of each other within the initial resistance range.

**MF-SM, MF-SM/33, MF-SM/60 & MF-SM/250 Series Tape and Reel Specifications**



NOTE: Effective December 1, 2010 (product date code V0), the cover tape will be changed to the new 3M™ Universal Cover Tape (UCT).

Tape Dimensions	MF-SM030, 050, 075, 100, 125, 260, 300; MF-SM075/60; MF-SM-100/33	MF-SM150, 200, 250; MF-SM-150/33, MF-SM-185/33; MF-SM013/250 per EIA 481-2
	per EIA-481-2	per EIA 481-2
W	$16.0 \pm 0.3$ (0.630 ± 0.012)	$16.0 \pm 0.3$ (0.630 ± 0.012)
P <sub>0</sub>	$4.0 \pm 0.1$ (0.157 ± 0.004)	$4.0 \pm 0.1$ (0.157 ± 0.004)
P <sub>1</sub>	$8.0 \pm 0.1$ (0.315 ± 0.004)	$12.0 \pm 0.1$ (0.472 ± 0.004)
P <sub>2</sub>	$2.0 \pm 0.1$ (0.079 ± 0.004)	$2.0 \pm 0.1$ (0.079 ± 0.004)
A <sub>0</sub>	$5.7 \pm 0.1$ (0.224 ± 0.004)	$6.9 \pm 0.1$ (0.272 ± 0.004)
B <sub>0</sub>	$8.1 \pm 0.1$ (0.319 ± 0.004)	$9.6 \pm 0.1$ (0.378 ± 0.004)
B <sub>1</sub> max.	$12.1$ (0.476)	$12.1$ (0.476)
D <sub>0</sub>	$1.5 + 0.1/-0.0$ (0.059 + 0.004/-0)	$1.5 + 0.1/-0.0$ (0.059 + 0.004/-0)
F	$7.5 \pm 0.1$ (0.295 ± 0.004)	$7.5 \pm 0.1$ (0.295 ± 0.004)
E <sub>1</sub>	$1.75 \pm 0.1$ (0.069 ± 0.004)	$1.75 \pm 0.1$ (0.069 ± 0.004)
E <sub>2</sub> min.	$14.25$ (0.561)	$14.25$ (0.561)
T max.	$0.6$ (0.024)	$0.6$ (0.024)
T <sub>1</sub> max.	$0.1$ (0.004)	$0.1$ (0.004)
K <sub>0</sub>	$3.4 \pm 0.1$ (0.134 ± 0.004)	$3.4 \pm 0.1^*$ (0.134 ± 0.004)*
Leader min.	$390$ (15.35)	$390$ (15.35)
Trailer min.	$160$ (6.30)	$160$ (6.30)
<b>Reel Dimensions</b>		
A max.	$360$ (14.17)	$360$ (14.17)
N min.	$50$ (1.97)	$50$ (1.97)
W <sub>1</sub>	$16.4 + 2.0/-0.0$ (0.646 + 0.079/-0)	$16.4 + 2.0/-0.0$ (0.646 + 0.079/-0)
W <sub>2</sub> max.	$22.4$ (0.882)	$22.4$ (0.882)

\* Model MF-SM013/250 =  $\frac{3.8 \pm 0.1}{(0.150 \pm 0.004)}$

DIMENSIONS:  $\frac{\text{MM}}{\text{(INCHES)}}$

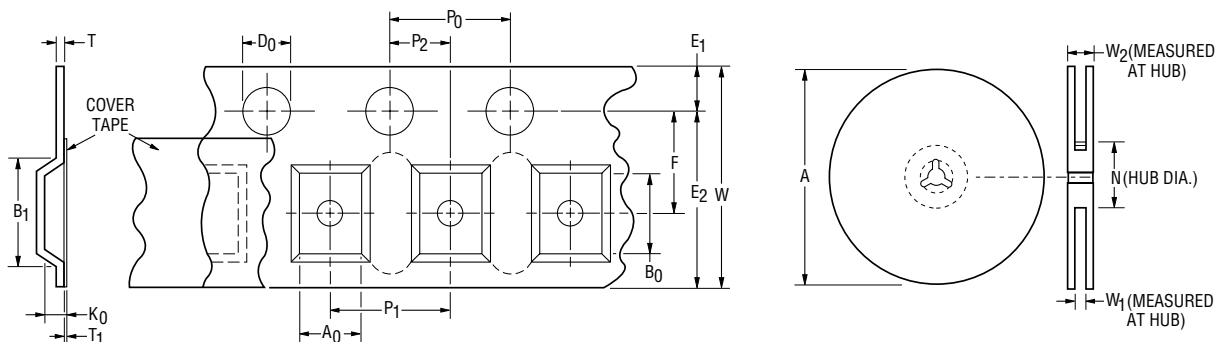

Specifications are subject to change without notice.  
Customers should verify actual device performance in their specific applications.

Компания «Океан Электроники» предлагает заключение долгосрочных отношений при поставках импортных электронных компонентов на взаимовыгодных условиях!

Наши преимущества:

- Поставка оригинальных импортных электронных компонентов напрямую с производств Америки, Европы и Азии, а так же с крупнейших складов мира;
- Широкая линейка поставок активных и пассивных импортных электронных компонентов (более 30 млн. наименований);
- Поставка сложных, дефицитных, либо снятых с производства позиций;
- Оперативные сроки поставки под заказ (от 5 рабочих дней);
- Экспресс доставка в любую точку России;
- Помощь Конструкторского Отдела и консультации квалифицированных инженеров;
- Техническая поддержка проекта, помощь в подборе аналогов, поставка прототипов;
- Поставка электронных компонентов под контролем ВП;
- Система менеджмента качества сертифицирована по Международному стандарту ISO 9001;
- При необходимости вся продукция военного и аэрокосмического назначения проходит испытания и сертификацию в лаборатории (по согласованию с заказчиком);
- Поставка специализированных компонентов военного и аэрокосмического уровня качества (Xilinx, Altera, Analog Devices, Intersil, Interpoint, Microsemi, Actel, Aeroflex, Peregrine, VPT, Syfer, Eurofarad, Texas Instruments, MS Kennedy, Miteq, Cobham, E2V, MA-COM, Hittite, Mini-Circuits, General Dynamics и др.);

Компания «Океан Электроники» является официальным дистрибьютором и эксклюзивным представителем в России одного из крупнейших производителей разъемов военного и аэрокосмического назначения «**JONHON**», а так же официальным дистрибьютором и эксклюзивным представителем в России производителя высокотехнологичных и надежных решений для передачи СВЧ сигналов «**FORSTAR**».



## JONHON

«**JONHON**» (основан в 1970 г.)

Разъемы специального, военного и аэрокосмического назначения:

(Применяются в военной, авиационной, аэрокосмической, морской, железнодорожной, горно- и нефтедобывающей отраслях промышленности)

«**FORSTAR**» (основан в 1998 г.)

ВЧ соединители, коаксиальные кабели, кабельные сборки и микроволновые компоненты:

(Применяются в телекоммуникациях гражданского и специального назначения, в средствах связи, РЛС, а так же военной, авиационной и аэрокосмической отраслях промышленности).



Телефон: 8 (812) 309-75-97 (многоканальный)

Факс: 8 (812) 320-03-32

Электронная почта: [ocean@oceanchips.ru](mailto:ocean@oceanchips.ru)

Web: <http://oceanchips.ru/>

Адрес: 198099, г. Санкт-Петербург, ул. Калинина, д. 2, корп. 4, лит. А