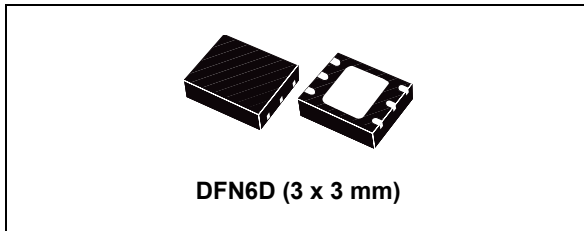

1.5 A, 1.5 MHz adjustable, step-down switching regulator

Datasheet - production data

Features

- Step-down current mode PWM (1.5 MHz) DC-DC converter
- 2% DC output voltage tolerance
- Internal soft-start for STARTUP current limitation and power on delay of 50 - 100 μ s
- Typical efficiency: > 70% over all operating conditions
- 1.5 A output current capability
- Not switching quiescent current: max 2.5 mA over temperature range
- Switch V_{DS} : max. 350 mV at $I_{SW} = 750$ mA
- Uses tiny capacitors and inductors
- Available in DFN6D 3 x 3 mm package with exposed pad

Description

The ST1S03 is a step-down DC-DC converter optimized for powering a low voltage digital core in HDD applications and, generally, to replace the high current linear solution when the power dissipation may cause a high heating of the application environment. It provides up to 1.5 A over an input voltage range of 3 V to 16 V. A high switching frequency (1.5 MHz) allows the use of tiny surface-mount components: as well as the resistor divider to set the output voltage value, only an inductor, a Schottky diode and two capacitors are required. Besides, a low output ripple is guaranteed by the current mode PWM topology and by the use of low ESR SMD ceramic capacitors. The device is thermal protected and current limited to prevent damages due to an accidental short-circuit. The ST1S03 device is available in a DFN6D package.

Table 1. Device summary

Order code	Package	Packaging
ST1S03PUR	DFN6D (3 x 3 mm)	Tape and reel

Contents

1	Diagram	3
2	Pin configuration	4
3	Maximum ratings	5
4	Electrical characteristics	6
5	Application notes	7
6	Typical application	8
7	Typical performance characteristics	9
8	Package information	12
9	Revision history	15

1 Diagram

Figure 1. Schematic diagram

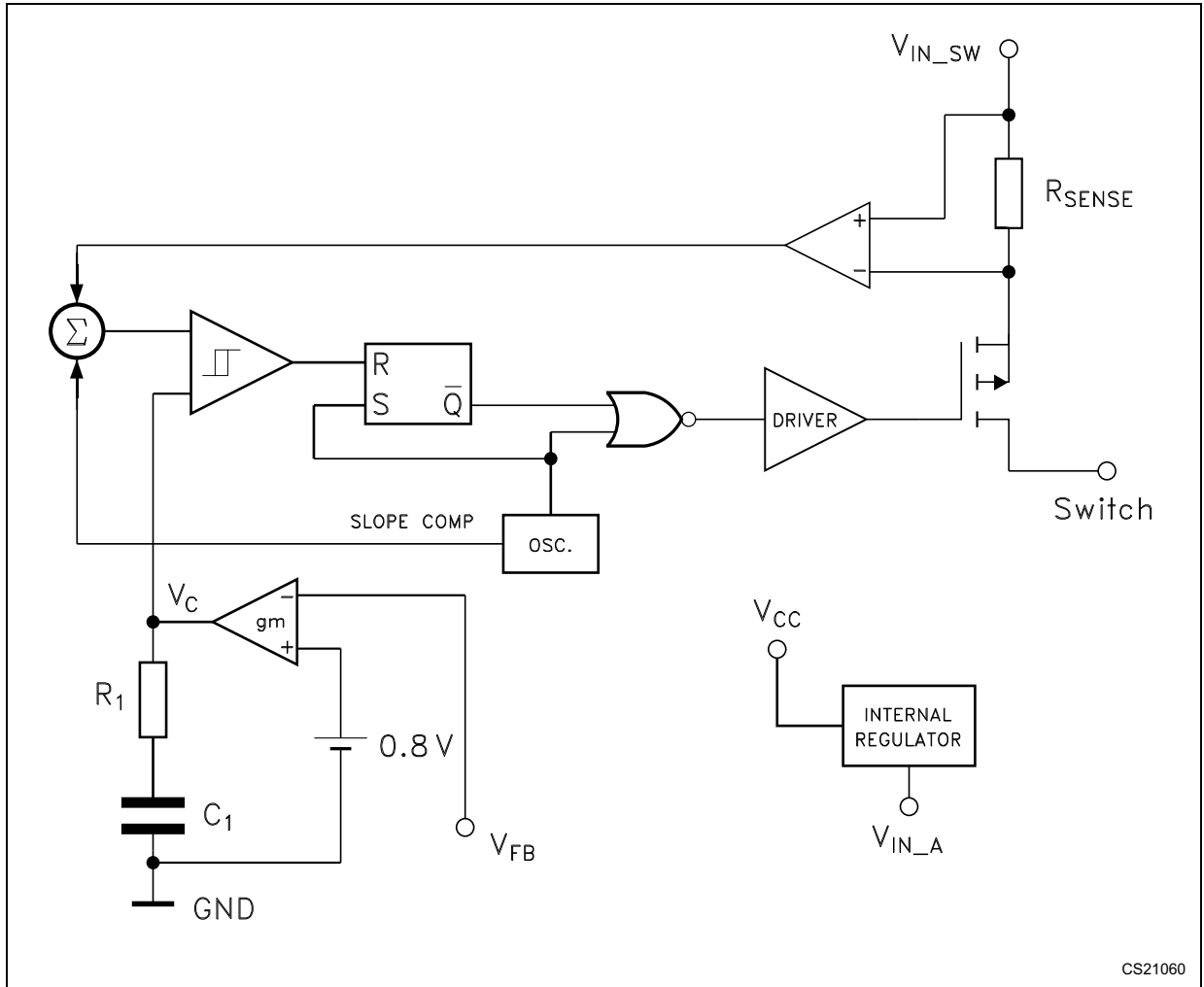

CS21060

2 Pin configuration

Figure 2. Pin connections (top view)

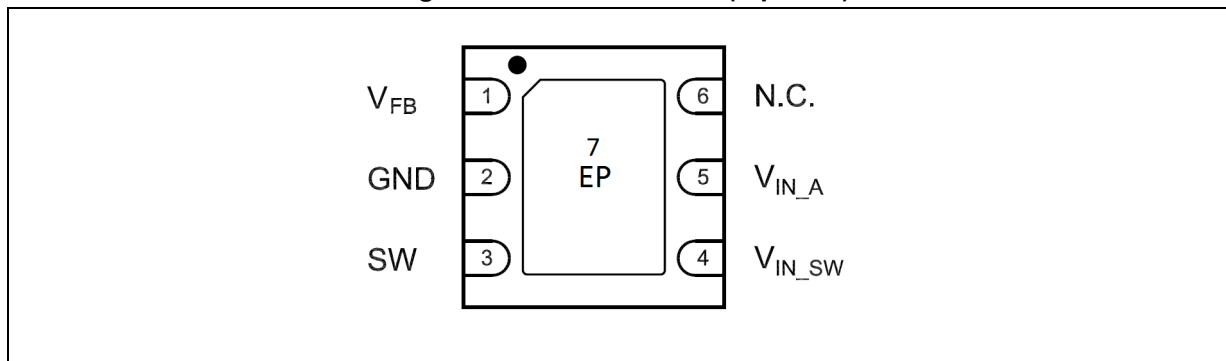

Table 2. Pin description

Pin no.	Symbol	Name and function
1	V_{FB}	Voltage of feedback
2	GND	System ground
3	SW	Output of the internal power switch
4	V_{IN_SW}	Power supply for the MOSFET switch
5	V_{IN_A}	Power supply for the analog circuit
6	N.C.	Not connected
7	EP	Exposed pad should be connected to GND

3 Maximum ratings

Table 3. Absolute maximum ratings

Symbol	Parameter	Value	Unit
V_{IN_SW}	Positive power supply voltage	-0.3 to 16	V
V_{IN_A}	Positive power supply voltage	-0.3 to 16	V
SWITCH voltage	Max voltage of output pin	-0.3 to 16	V
V_{FB}	Feedback voltage	2.5	V
I_{VFB}	Common mode input voltage	± 1	mA
T_J	Max junction temperature	150	$^{\circ}\text{C}$
T_{STG}	Storage temperature range	-25 to 150	$^{\circ}\text{C}$
T_{LEAD}	Lead temperature (soldering) 10 s	300	$^{\circ}\text{C}$

Note: Absolute maximum ratings are those values beyond which damage to the device may occur. Functional operation under these conditions is not implied.

Table 4. Thermal data

Symbol	Parameter	Value	Unit
R_{thJC}	Thermal resistance junction case	10	$^{\circ}\text{C}/\text{W}$
R_{thJA}	Thermal resistance junction ambient	55	$^{\circ}\text{C}/\text{W}$

4 Electrical characteristics

Table 5. Electrical characteristics ($V_{IN_SW} = V_{IN_A} = 5\text{ V}$, $C_I = 4.7\ \mu\text{F}$, $C_O = 22\ \mu\text{F}$, $L1 = 3.3\ \mu\text{H}$, $T_J = 0\text{ to }125\text{ }^\circ\text{C}$, unless otherwise specified. Typical values are referred to $25\text{ }^\circ\text{C}$)

Symbol	Parameter	Test conditions	Min.	Typ.	Max.	Unit
FB	Feedback voltage	$I_O = 100\text{ mA}$	784	800	816	mV
I_{FB}	V_{FB} pin bias current				600	nA
I_Q	Quiescent current	No switching			2.5	mA
I_O	Output current	$V_{IN} = 3\text{ V to }16\text{ V}$	1.5			A
I_{MIN}	Minimum output current		1			mA
$\%V_O/\Delta V_{IN}$	Reference line regulation	$V_{IN} = 3\text{ V to }16\text{ V}$		0.032	0.06	$\% V_O/\Delta V_{IN}$
$\%V_O/\Delta I_O$	Reference load regulation	$I_O = 10\text{ mA to }1.2\text{ A}$		0.0014	0.003	$\% V_O/\text{mA}$
PWM f_S	PWM switching frequency ⁽¹⁾	$V_{FB} = 0.8\text{ V}$, $T_A = 25\text{ }^\circ\text{C}$	1.2	1.5	1.8	MHz
D_{MAX}	Maximum duty cycle			87		%
I_{SWL}	Switching current limitation		1.65			A
V_{DS}	Switch V_{DS}	$I_{SW} = 750\text{ mA}$		200	350	mV
E	Efficiency	$I_O = 10\text{ mA to }1.2\text{ A}$	70			%
T_{SHDN}	Thermal shutdown ⁽¹⁾		130	150		$^\circ\text{C}$
T_{HYS}	Thermal shutdown hysteresis ⁽¹⁾			15		$^\circ\text{C}$
$\Delta V_O/\Delta I_O$	Load transient response ⁽¹⁾	$I_O = 100\text{ mA to }700\text{ mA}$ $t_R = t_F \geq 100\text{ ns}$, $T_A = 25\text{ }^\circ\text{C}$	-5		+5	$\% V_O$
$\Delta V_O/\Delta I_O$ at $I_O = \text{short}$	Short-circuit removal response ⁽¹⁾	$I_O = 10\text{ mA to short}$, $T_A = 25\text{ }^\circ\text{C}$			+5	$\% V_O$

1. Guaranteed by design, but not tested in production.

5 Application notes

The ST1S03 is an adjustable current mode PWM step-down DC-DC converter with an internal 1.5 A power switch, housed in a 6-lead DFN 3 x 3 mm package.

It's a complete 1.5 A switching regulator with its internal compensation eliminating an additional component.

The constant frequency, current mode, PWM architecture and stable operation with ceramic capacitors results in a low, predictable output ripple. However, in order to keep the output regulated, the device goes in pulse skipping mode when a very light load is required.

To clamp the error amplifier reference voltage, a soft-start control block generating a voltage ramp has been implemented. Besides an on-chip power on reset of 50 = 100 μ s ensures the proper operation when switching on the power supply. Other circuits fitted to the device protection are the thermal shutdown blocks which turn off the regulator when the junction temperature exceeds 150 °C typically and the cycle-by-cycle current limiting that provides protection against shorted outputs.

Being the ST1S03 an adjustable regulator, the output voltage is determined by an external resistor divider. The desired value is given by the following equation:

$$V_O = V_{FB} [1 + R1 / R2]$$

To make the device working, only other four external components are required: a Schottky diode, an inductor and two capacitors. The chosen inductor must be able to not saturate at the peak current level. Besides, its value can be selected keeping in account that a large inductor value increases the efficiency at a low output current and reduces an output voltage ripple, while a smaller inductor can be chosen when it is important to reduce the package size and the total cost of the application. Finally, the ST1S03 device has been designed to work properly with the X5R or X7R SMD ceramic capacitors both at the input and at the output. This kind of capacitors, thanks to their very low series resistance (ESR), minimize the output voltage ripple. Other low ESR capacitors can be used according to the need of the application without invalidating the right functioning of the device. Due to the high switching frequency and peak current, it is important to optimize the application environment reducing the length of the PCB traces and placing all the external components near the device.

6 Typical application

Figure 3. Application circuits

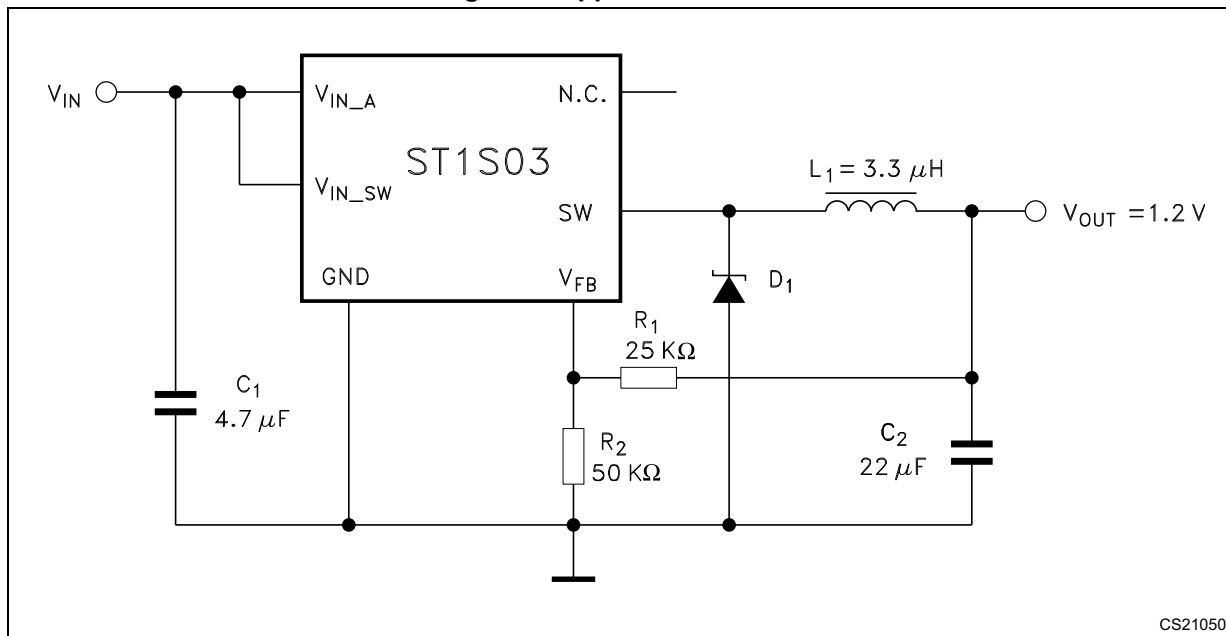

CS21050

7 Typical performance characteristics

($L_1 = 3.3 \mu\text{H}$, $C_1 = 4.7 \mu\text{F}$, $C_O = 22 \mu\text{F}$, unless otherwise specified).

Figure 4. Load voltage feedback vs. temp.

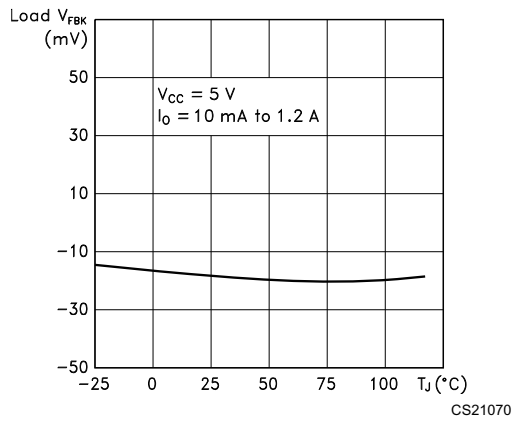

Figure 5. Voltage feedback vs. temperature

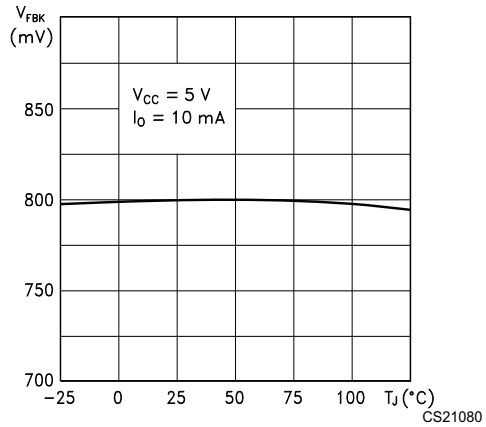

Figure 6. Line output voltage regulation vs. temperature

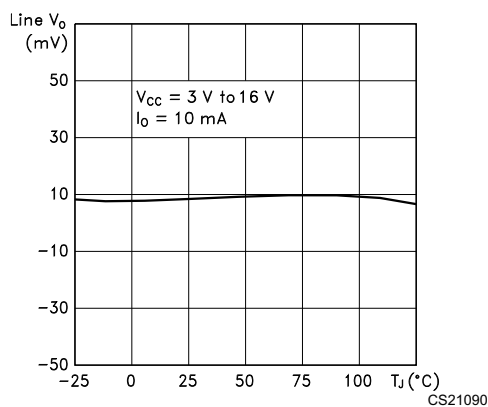

Figure 7. Line voltage feedback vs. temperature

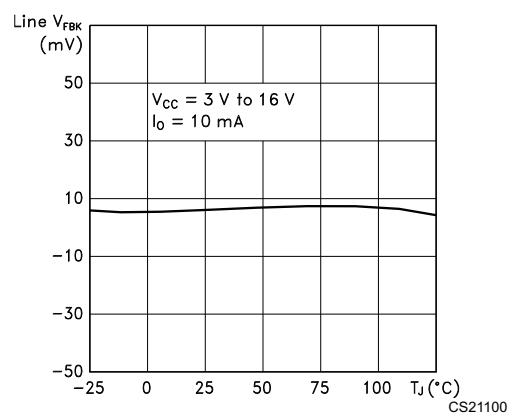

Figure 8. Voltage feedback vs. output current

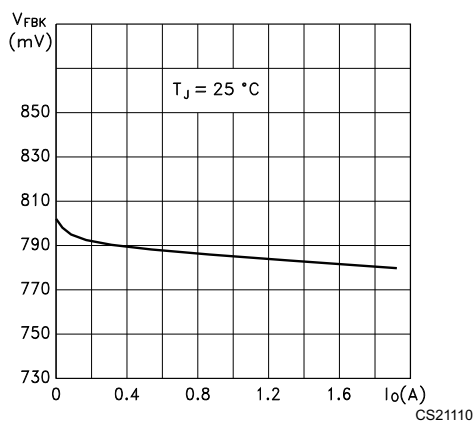

Figure 9. PWM Switching frequency vs. temp.

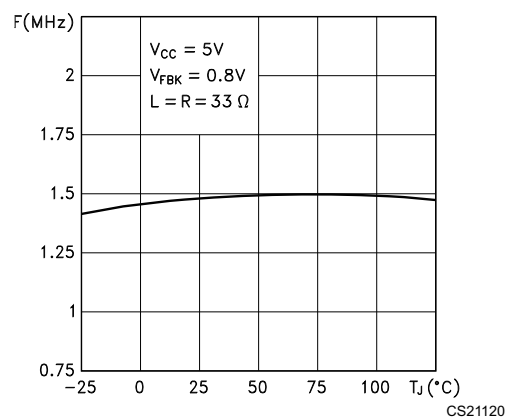

Figure 10. Quiescent current vs. temperature

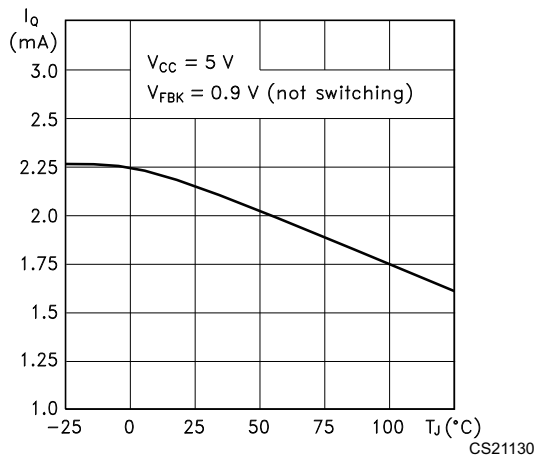

Figure 11. Quiescent current vs. input voltage

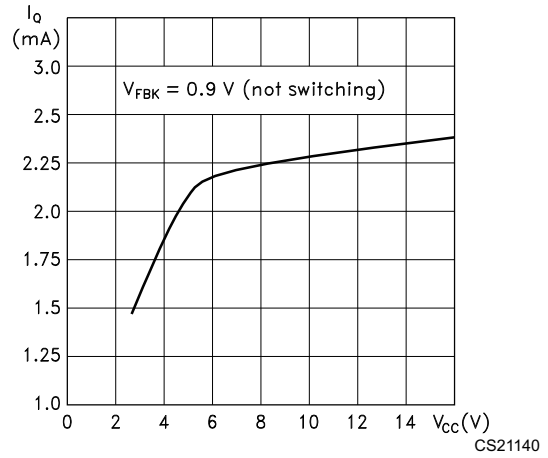

Figure 12. Minimum operating voltage vs. output voltage

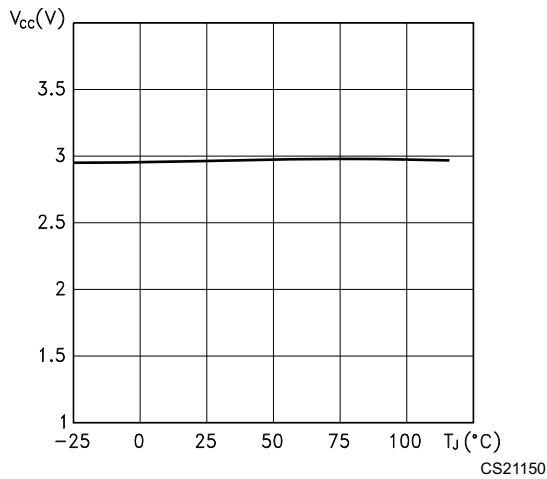

Figure 13. Efficiency vs. temperature

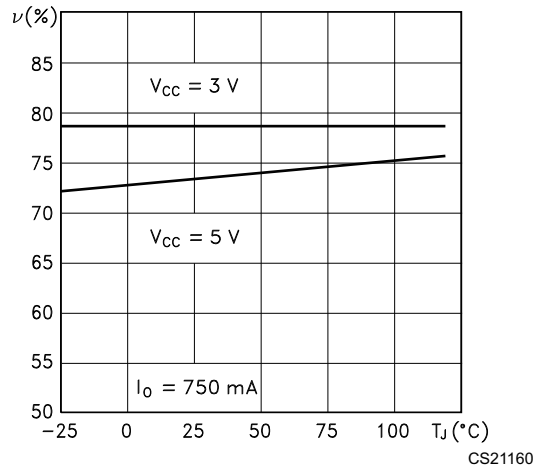

Figure 14. Efficiency vs. output current

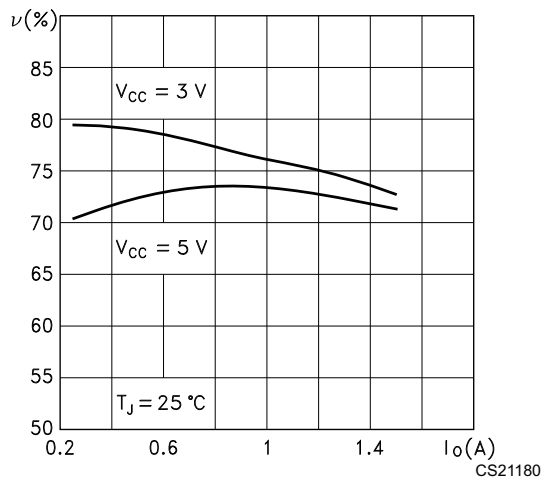

Figure 15. Switch V_{DS} vs. temperature

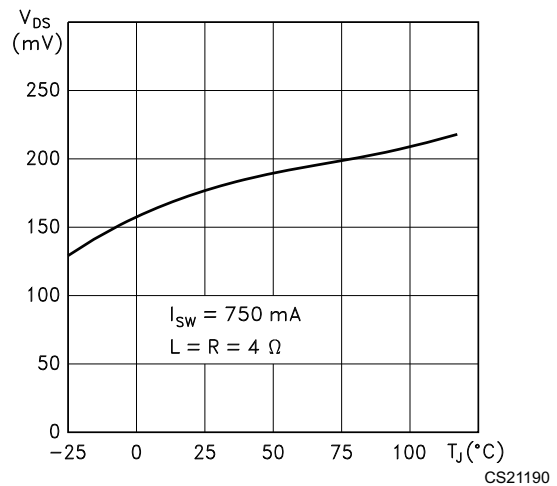

Figure 16. Switch RDS-ON vs. temperature

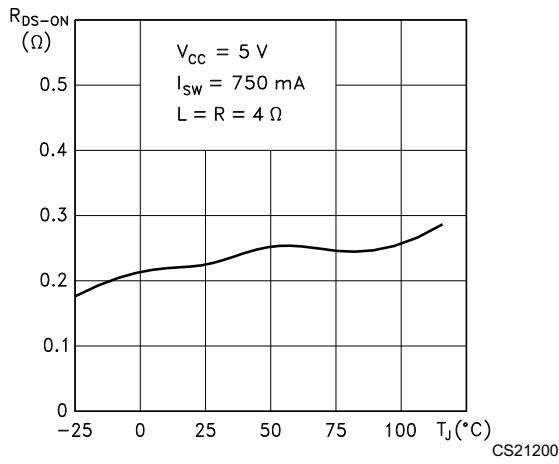

Figure 17. Switch current limitation vs. temperature

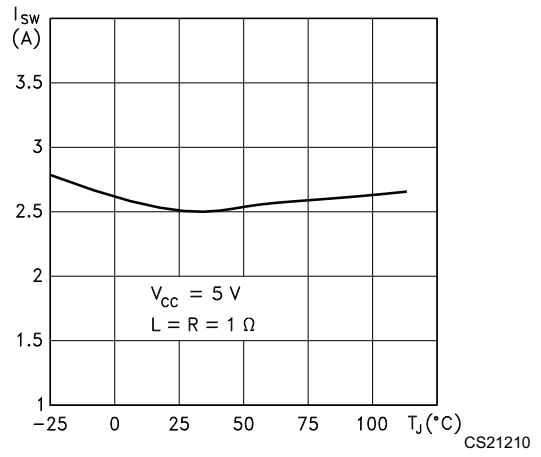

Figure 18. Load transient response

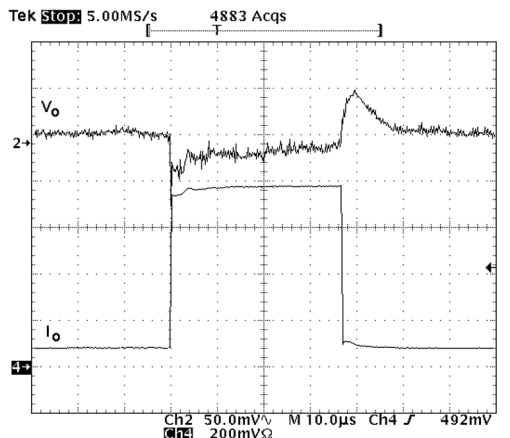

Figure 19. Load transient response

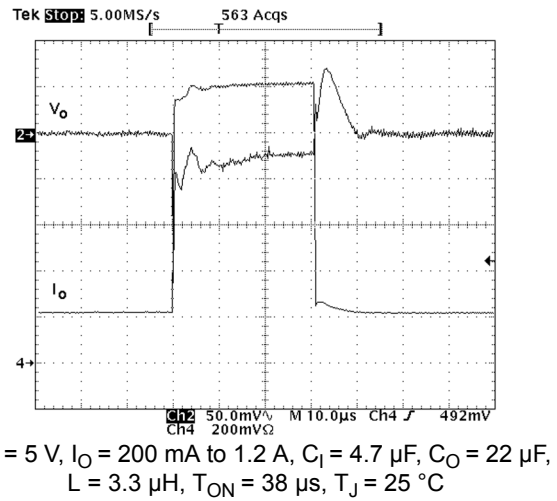

Figure 20. Startup transient

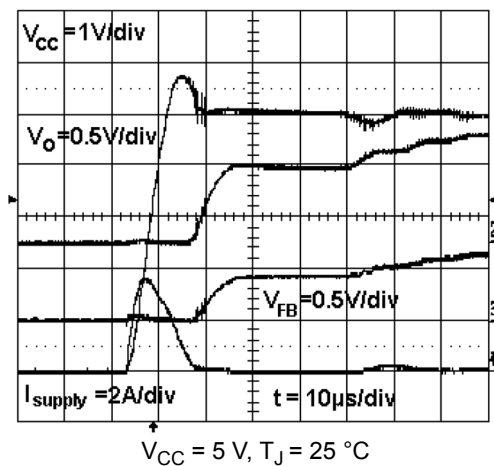
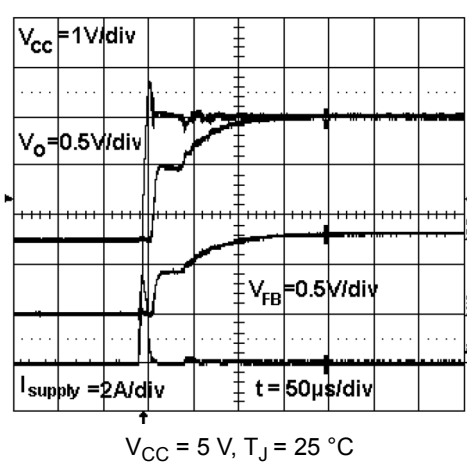

Figure 21. Startup transient



8 Package information

In order to meet environmental requirements, ST offers these devices in different grades of ECOPACK[®] packages, depending on their level of environmental compliance. ECOPACK specifications, grade definitions and product status are available at: www.st.com. ECOPACK is an ST trademark.

Figure 23. Tape and reel QFNxx/DFNxx (3 x 3 mm) package outline⁽¹⁾

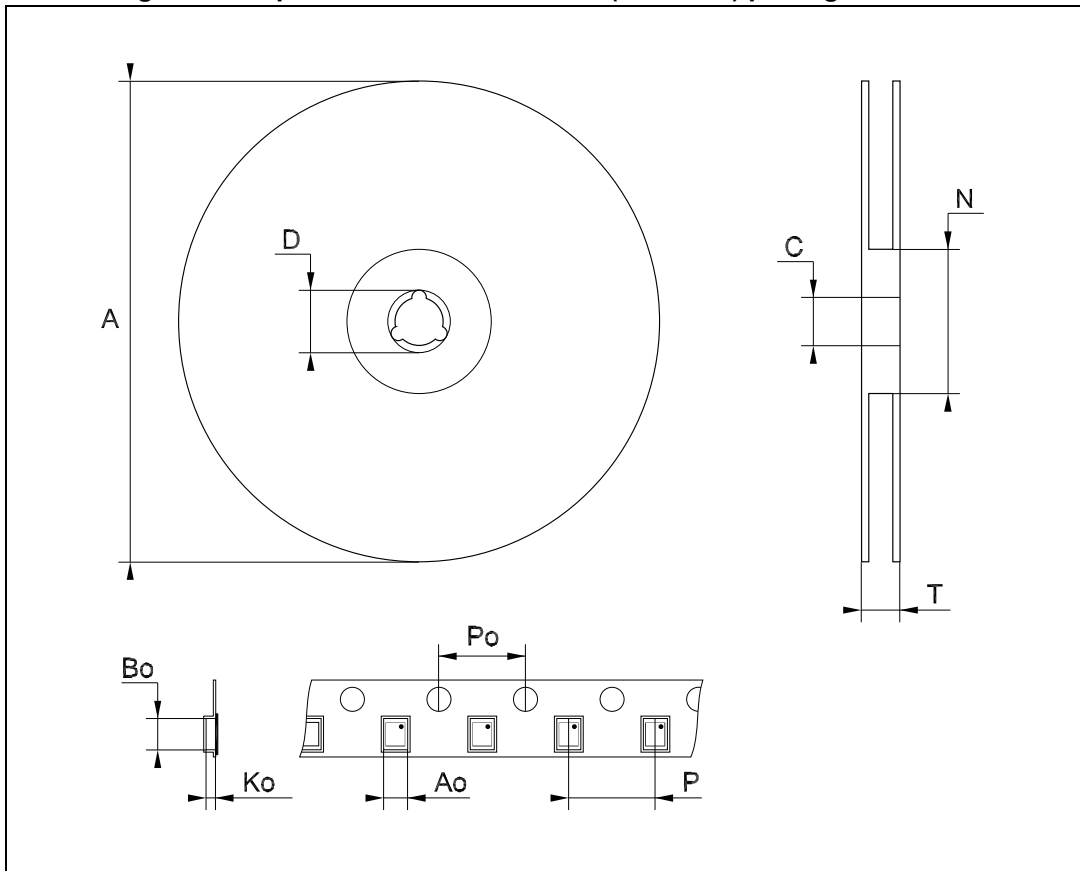

1. Drawing is not in scale.

Table 7. Tape and reel QFNxx/DFNxx (3 x 3 mm) package mechanical data

Symbol	Dimensions (mm)			Dimensions (inch)		
	Min.	Typ.	Max.	Min.	Typ.	Max.
A			330			12.992
C	12.8		13.2	0.504		0.519
D	20.2			0.795		
N	60			2.362		
T			18.4			0.724
Ao		3.3			0.130	
Bo		3.3			0.130	
Ko		1.1			0.043	
Po		4			0.157	
P		8			0.315	

9 Revision history

Table 8. Document revision history

Date	Revision	Changes
11-Nov-2004	1	First Release.
08-Feb-2005	2	Maturity Change.
03-Mar-2005	3	Mistake on Figure 1, T _J is changed 125 ==> 150°C on Table 3.
13-Jul-2005	4	Add new package SO-8 exposed pad.
29-Mar-2007	5	Package SO-8 removed.
07-Mar-2008	6	Removed: package mechanical data DFN6.
14-Nov-2014	7	<p>Updated Table 1: Device summary on page 1 (updated Packaging).</p> <p>Updated Figure 2: Pin connections (top view) on page 4 (replaced by new figure).</p> <p>Updated Table 2: Pin description on page 4 (added row 7).</p> <p>Updated Section 8: Package information on page 12 (updated and added titles, updated ECOPACK text, reversed order of Figure 22 and Table 6, Figure 23 and Table 7, updated headings of Table 6 and Table 7).</p> <p>Minor modifications throughout document.</p>

IMPORTANT NOTICE – PLEASE READ CAREFULLY

STMicroelectronics NV and its subsidiaries ("ST") reserve the right to make changes, corrections, enhancements, modifications, and improvements to ST products and/or to this document at any time without notice. Purchasers should obtain the latest relevant information on ST products before placing orders. ST products are sold pursuant to ST's terms and conditions of sale in place at the time of order acknowledgement.

Purchasers are solely responsible for the choice, selection, and use of ST products and ST assumes no liability for application assistance or the design of Purchasers' products.

No license, express or implied, to any intellectual property right is granted by ST herein.

Resale of ST products with provisions different from the information set forth herein shall void any warranty granted by ST for such product.

ST and the ST logo are trademarks of ST. All other product or service names are the property of their respective owners.

Information in this document supersedes and replaces information previously supplied in any prior versions of this document.

© 2014 STMicroelectronics – All rights reserved

Компания «Океан Электроники» предлагает заключение долгосрочных отношений при поставках импортных электронных компонентов на взаимовыгодных условиях!

Наши преимущества:

- Поставка оригинальных импортных электронных компонентов напрямую с производств Америки, Европы и Азии, а так же с крупнейших складов мира;
- Широкая линейка поставок активных и пассивных импортных электронных компонентов (более 30 млн. наименований);
- Поставка сложных, дефицитных, либо снятых с производства позиций;
- Оперативные сроки поставки под заказ (от 5 рабочих дней);
- Экспресс доставка в любую точку России;
- Помощь Конструкторского Отдела и консультации квалифицированных инженеров;
- Техническая поддержка проекта, помощь в подборе аналогов, поставка прототипов;
- Поставка электронных компонентов под контролем ВП;
- Система менеджмента качества сертифицирована по Международному стандарту ISO 9001;
- При необходимости вся продукция военного и аэрокосмического назначения проходит испытания и сертификацию в лаборатории (по согласованию с заказчиком);
- Поставка специализированных компонентов военного и аэрокосмического уровня качества (Xilinx, Altera, Analog Devices, Intersil, Interpoint, Microsemi, Actel, Aeroflex, Peregrine, VPT, Syfer, Eurofarad, Texas Instruments, MS Kennedy, Miteq, Cobham, E2V, MA-COM, Hittite, Mini-Circuits, General Dynamics и др.);

Компания «Океан Электроники» является официальным дистрибьютором и эксклюзивным представителем в России одного из крупнейших производителей разъемов военного и аэрокосмического назначения «**JONHON**», а так же официальным дистрибьютором и эксклюзивным представителем в России производителя высокотехнологичных и надежных решений для передачи СВЧ сигналов «**FORSTAR**».



JONHON

«**JONHON**» (основан в 1970 г.)

Разъемы специального, военного и аэрокосмического назначения:

(Применяются в военной, авиационной, аэрокосмической, морской, железнодорожной, горно- и нефтедобывающей отраслях промышленности)

«**FORSTAR**» (основан в 1998 г.)

ВЧ соединители, коаксиальные кабели, кабельные сборки и микроволновые компоненты:

(Применяются в телекоммуникациях гражданского и специального назначения, в средствах связи, РЛС, а так же военной, авиационной и аэрокосмической отраслях промышленности).



Телефон: 8 (812) 309-75-97 (многоканальный)

Факс: 8 (812) 320-03-32

Электронная почта: ocean@oceanchips.ru

Web: <http://oceanchips.ru/>

Адрес: 198099, г. Санкт-Петербург, ул. Калинина, д. 2, корп. 4, лит. А