

The S-8355/56/57/58 Series is a CMOS step-up switching regulator controller which mainly consists of a reference voltage source, an oscillation circuit, an error amplifier, a phase compensation circuit, a PWM control circuit (S-8355/57 Series) and a PWM/PFM switching control circuit (S-8356/58 Series).

With an external low-ON-resistance Nch Power MOS, this product is ideal for applications requiring high efficiency and a high output current.

The S-8355/57 Series realizes low ripple, high efficiency, and excellent transient characteristics due to its PWM control circuit whose duty ratio can be varied linearly from 0 to 83% (from 0 to 78% for 250 kHz, 300 kHz, and 600 kHz models), an excellently designed error amplifier and a phase compensation circuits.

S-8356/58 Series features a PWM/PFM switching controller that can switch the operation to a PFM controller with a duty ratio is 15% under a light load to prevent a decline in the efficiency due to the IC operating current.

## ■ Features

- Low voltage operation : Startup at 0.9 V min. ( $I_{OUT} = 1$  mA) guaranteed
- Low current consumption : During operation 25.9  $\mu$ A (3.3 V, 100 kHz, typ.)  
During shutdown 0.5  $\mu$ A (max.)
- Duty ratio : Built-in PWM/PFM switching control circuit (S-8356/58 Series)  
15 to 83% (100 kHz models)  
15 to 78% (250 kHz, 300 kHz, and 600 kHz models)
- External parts : Coil, diode, capacitor, and transistor
- Output voltage : Selectable in 0.1 V steps between 1.5 and 6.5 V (for  $V_{DD}$  /  $V_{OUT}$  separate types)  
Selectable in 0.1 V steps between 2.0 and 6.5 V (for other than  $V_{DD}$  /  $V_{OUT}$  separate types)
- Output voltage accuracy :  $\pm 2.4\%$
- Oscillation frequency : 100 kHz, 250 kHz, 300 kHz, 600 kHz selectable
  
- Soft start function : 6 ms (100 kHz, typ.)
- Shutdown function
- Lead-free, Sn 100%, halogen-free<sup>\*1</sup>

\*1. Refer to "■ Product Name Structure" for details.

## ■ Applications

- Power supplies for portable equipment such as digital cameras, electronic notebooks, and PDAs
- Power supplies for audio equipment such as portable CD / MD players
- Constant voltage power supplies for cameras, VCRs, and communications devices
- Power supplies for microcomputers

## ■ Packages

- SOT-23-3
- SOT-23-5
- SOT-89-3

■ **Block Diagrams**

(1) **S-8357/58 Series B, H and F Types**  
 (Without Shutdown Function)



**Figure 1**

(2) **S-8357/58 Series B, H, F and N Types**  
 (With Shutdown Function)



**Figure 2**

(3) **S-8357/58 Series E, J, G and P Types**  
 ( $V_{DD}$  /  $V_{OUT}$  Separate Type)



**Figure 3**

(4) **S-8355/56 Series K, L, M and Q Types**  
 (With Shutdown Function,  $V_{DD}$  /  $V_{OUT}$  Separate Type)



**Figure 4**

■ **Product Name Structure**

The control system, product types, output voltage, and packages for the S-8355/56/57/58 Series can be selected at the user's request. Please refer to the "3. Product Name" for the definition of the product name, "4. Package" regarding the package drawings and "5. Product Name List" for the full product names.

1. **Function List**

(1) **PWM Control Products**

Table 1

| Product Name | Switching Frequency kHz | Shutdown Function | V <sub>DD</sub> / V <sub>OUT</sub> Separate Type | Package  | Application  |
|--------------|-------------------------|-------------------|--|----------|--|
| S-8355KxxMC  | 100                     | Yes               | Yes  | SOT-23-5 | Applications requiring variable output voltage and a shutdown function                   |
| S-8355LxxMC  | 250                     | Yes               | Yes  | SOT-23-5 | Applications requiring variable output voltage, a shutdown function, and a thin coil     |
| S-8355MxxMC  | 300                     | Yes               | Yes  | SOT-23-5 | Applications requiring variable output voltage, a shutdown function, and a thin coil     |
| S-8355QxxMC  | 600                     | Yes               | Yes  | SOT-23-5 | Applications requiring variable output voltage, a shutdown function, and a thin coil     |
| S-8357BxxMC  | 100                     | Yes               | –  | SOT-23-5 | Applications requiring a shutdown function   |
| S-8357BxxMA  | 100                     | –                 | –  | SOT-23-3 | Applications not requiring a shutdown function   |
| S-8357BxxUA  | 100                     | –                 | –  | SOT-89-3 | Applications not requiring a shutdown function   |
| S-8357ExxMC  | 100                     | –                 | Yes  | SOT-23-5 | Applications in which output voltage is adjusted by external resistor                    |
| S-8357FxxMC  | 300                     | Yes               | –  | SOT-23-5 | Applications requiring a shutdown function and a thin coil                               |
| S-8357GxxMC  | 300                     | –                 | Yes  | SOT-23-5 | Applications requiring variable output voltage and a thin coil                           |
| S-8357HxxMC  | 250                     | Yes               | –  | SOT-23-5 | Applications requiring a shutdown function and a thin coil                               |
| S-8357JxxMC  | 250                     | –                 | Yes  | SOT-23-5 | Applications requiring variable output voltage with an external resistor and a thin coil |
| S-8357NxxMC  | 600                     | Yes               | –  | SOT-23-5 | Applications requiring a shutdown function and a thin coil                               |
| S-8357PxxMC  | 600                     | –                 | Yes  | SOT-23-5 | Applications requiring variable output voltage with an external resistor and a thin coil |

(2) PWM / PFM Switching Control Products

Table 2

| Product Name | Switching Frequency kHz | Shutdown Function | V <sub>DD</sub> / V <sub>OUT</sub> Separate Type | Package  | Application  |
|--------------|-------------------------|-------------------|--|----------|--|
| S-8356KxxMC  | 100                     | Yes               | Yes  | SOT-23-5 | Applications requiring variable output voltage and a shutdown function                   |
| S-8356LxxMC  | 250                     | Yes               | Yes  | SOT-23-5 | Applications requiring variable output voltage, a shutdown function, and a thin coil     |
| S-8356MxxMC  | 300                     | Yes               | Yes  | SOT-23-5 | Applications requiring variable output voltage, a shutdown function, and a thin coil     |
| S-8356QxxMC  | 600                     | Yes               | Yes  | SOT-23-5 | Applications requiring variable output voltage, a shutdown function, and a thin coil     |
| S-8358BxxMC  | 100                     | Yes               | –  | SOT-23-5 | Applications requiring a shutdown function   |
| S-8358BxxMA  | 100                     | –                 | –  | SOT-23-3 | Applications not requiring a shutdown function   |
| S-8358BxxUA  | 100                     | –                 | –  | SOT-89-3 | Applications not requiring a shutdown function   |
| S-8358ExxMC  | 100                     | –                 | Yes  | SOT-23-5 | Applications in which output voltage is adjusted by external resistor                    |
| S-8358FxxMC  | 300                     | Yes               | –  | SOT-23-5 | Applications requiring a shutdown function and a thin coil                               |
| S-8358GxxMC  | 300                     | –                 | Yes  | SOT-23-5 | Applications requiring variable output voltage and a thin coil                           |
| S-8358HxxMC  | 250                     | Yes               | –  | SOT-23-5 | Applications requiring a shutdown function and a thin coil                               |
| S-8358JxxMC  | 250                     | –                 | Yes  | SOT-23-5 | Applications requiring variable output voltage with an external resistor and a thin coil |
| S-8358NxxMC  | 600                     | Yes               | –  | SOT-23-5 | Applications requiring a shutdown function and a thin coil                               |
| S-8358PxxMC  | 600                     | –                 | Yes  | SOT-23-5 | Applications requiring variable output voltage with an external resistor and a thin coil |

2. Package and Function List by Product Type

Table 3

| Series Name                  | Type  | Package Name (Abbreviation) | Shutdown Function Yes / No | V <sub>DD</sub> / V <sub>OUT</sub> Separate Type Yes / No |
|------------------------------|---|-----------------------------|----------------------------|---|
| S-8355 Series, S-8356 Series | K, L, M, Q (Shutdown function + V <sub>DD</sub> / V <sub>OUT</sub> separate type)<br>K = 100 kHz, L = 250 kHz, M = 300 kHz, Q = 600 kHz | MC                          | Yes                        | Yes   |
| S-8357 Series                | B, H, F (Normal product)<br>B = 100 kHz, H = 250 kHz, F = 300 kHz   | MA / UA                     | No                         | No  |
|                              |   | MC                          | Yes                        |   |
|                              | N (Normal product)<br>N = 600 kHz   | MC                          | Yes                        | No  |
|                              | E, J, G, P (V <sub>DD</sub> / V <sub>OUT</sub> separate type)<br>E = 100 kHz, J = 250 kHz, G = 300 kHz, P = 600 kHz                     | MC                          | No                         | Yes   |
| S-8358 Series                | B, H, F (Normal product)<br>B = 100 kHz, H = 250 kHz, F = 300 kHz   | MA / UA                     | No                         | No  |
|                              |   | MC                          | Yes                        |   |
|                              | N (Normal product)<br>N = 600 kHz   | MC                          | Yes                        | No  |
|                              | E, J, G, P (V <sub>DD</sub> / V <sub>OUT</sub> separate type)<br>E = 100 kHz, J = 250 kHz, G = 300 kHz, P = 600 kHz                     | MC                          | No                         | Yes   |

3. Product Name

(1) SOT-23-3 Packages

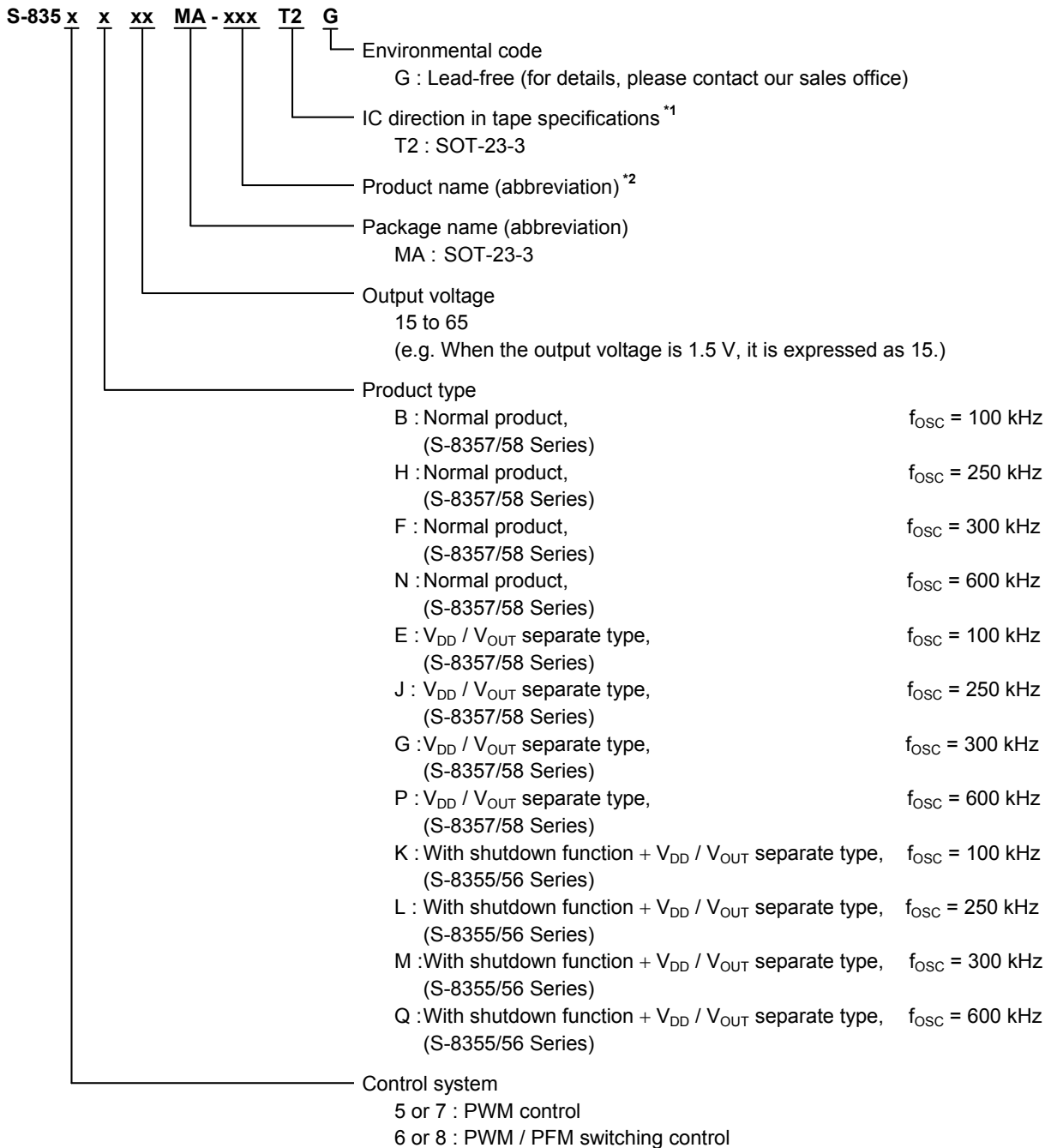

\*1. Refer to the tape specifications.

\*2. Refer to the **Table 4** to **Table 11** in the “**5. Product Name List**”.

(2) SOT-23-5, SOT-89-3 Packages



\*1. Refer to the tape specifications.

\*2. Refer to the Table 4 to Table 11 in the "5. Product Name List".

4. Package

| Package Name | Drawing Code |              |              |
|--------------|--------------|--------------|--------------|
|              | Package      | Tape         | Reel         |
| SOT-23-3     | MP003-A-P-SD | MP003-A-C-SD | MP003-A-R-SD |
| SOT-23-5     | MP005-A-P-SD | MP005-A-C-SD | MP005-A-R-SD |
| SOT-89-3     | UP003-A-P-SD | UP003-A-C-SD | UP003-A-R-SD |

**5. Product Name List**

**(1) S-8355 Series**

**Table 4**

| Output voltage | S-8355KxxMC Series | S-8355LxxMC Series | S-8355MxxMC Series | S-8355QxxMC Series |
|----------------|--------------------|--------------------|--------------------|--------------------|
| 1.5 V          | –                  | S-8355L15MC-NCAT2x | –                  | S-8355Q15MC-OWAT2x |
| 1.8 V          | S-8355K18MC-NADT2x | –                  | S-8355M18MC-MCDT2x | S-8355Q18MC-OWDT2x |
| 2.0 V          | S-8355K20MC-NAFT2x | S-8355L20MC-NCFT2x | S-8355M20MC-MCFT2x | S-8355Q20MC-OWFT2x |
| 2.4 V          | S-8355K24MC-NAJT2x | –                  | –                  | S-8355Q24MC-OWJT2x |
| 2.8 V          | –                  | –                  | –                  | S-8355Q28MC-OWNT2x |
| 3.0 V          | S-8355K30MC-NAPT2x | –                  | S-8355M30MC-MCPT2x | S-8355Q30MC-OWPT2x |
| 3.1 V          | S-8355K31MC-NAQT2x | –                  | S-8355M31MC-MCQT2x | S-8355Q31MC-OWQT2x |
| 3.2 V          | –                  | –                  | S-8355M32MC-MCRT2x | –                  |
| 3.3 V          | S-8355K33MC-NAST2x | –                  | –                  | S-8355Q33MC-OWST2x |
| 3.4 V          | –                  | –                  | S-8355M34MC-MCTT2x | S-8355Q34MC-OWTT2x |
| 4.5 V          | –                  | –                  | –                  | S-8355Q45MC-OXET2x |
| 5.0 V          | S-8355K50MC-NBJT2x | –                  | S-8355M50MC-MDJT2x | S-8355Q50MC-OXJT2x |
| 5.1 V          | –                  | –                  | –                  | S-8355Q51MC-OXKT2x |
| 5.5 V          | –                  | –                  | S-8355M55MC-MDOT2x | –                  |
| 6.0 V          | –                  | –                  | S-8355M60MC-MDTT2x | S-8355Q60MC-OXTT2x |
| 6.5 V          | –                  | –                  | S-8355M65MC-MDYT2x | –                  |

- Remark 1.** Please contact the ABLIC Inc. marketing department for products with an output voltage other than those specified above.
2. x: G or U
  3. Please select products of environmental code = U for Sn 100%, halogen-free products.

**(2) S-8356 Series**

**Table 5**

| Output voltage | S-8356KxxMC Series | S-8356LxxMC Series | S-8356MxxMC Series | S-8356QxxMC Series |
|----------------|--------------------|--------------------|--------------------|--------------------|
| 1.5 V          | –                  | –                  | S-8356M15MC-MEAT2x | –                  |
| 1.8 V          | S-8356K18MC-NEDT2x | –                  | S-8356M18MC-MEDT2x | S-8356Q18MC-OYDT2x |
| 2.8 V          | –                  | –                  | –                  | S-8356Q28MC-OYNT2x |
| 3.0 V          | S-8356K30MC-NEPT2x | S-8356L30MC-NGPT2x | S-8356M30MC-MEPT2x | S-8356Q30MC-OYPT2x |
| 3.1 V          | –                  | –                  | S-8356M31MC-MEQT2x | S-8356Q31MC-OYQT2x |
| 3.3 V          | S-8356K33MC-NEST2x | –                  | S-8356M33MC-MEST2x | S-8356Q33MC-OYST2x |
| 3.5 V          | –                  | –                  | S-8356M35MC-MEUT2x | S-8356Q35MC-OYUT2x |
| 3.6 V          | S-8356K36MC-NEVT2x | –                  | S-8356M36MC-MEVT2x | –                  |
| 4.0 V          | S-8356K40MC-NEZT2x | –                  | –                  | S-8356Q40MC-OYZT2x |
| 5.0 V          | S-8356K50MC-NFJT2x | –                  | S-8356M50MC-MFJT2x | S-8356Q50MC-OVJT2x |
| 5.3 V          | –                  | –                  | –                  | S-8356Q53MC-OVMT2x |

- Remark 1.** Please contact the ABLIC Inc. marketing department for products with an output voltage other than those specified above.
2. x: G or U
  3. Please select products of environmental code = U for Sn 100%, halogen-free products.

(3) S-8357 Series

Table 6

| Output voltage | S-8357BxxMC Series | S-8357BxxMA Series | S-8357BxxUA Series | S-8357ExxMC Series |
|----------------|--------------------|--------------------|--------------------|--------------------|
| 1.5 V          | –                  | –                  | –                  | S-8357E15MC-NKAT2x |
| 2.0 V          | –                  | –                  | –                  | S-8357E20MC-NKFT2x |
| 2.5 V          | S-8357B25MC-NIKT2x | –                  | –                  | –                  |
| 2.6 V          | S-8357B26MC-NILT2x | –                  | –                  | –                  |
| 2.7 V          | S-8357B27MC-NIMT2x | –                  | –                  | –                  |
| 2.8 V          | S-8357B28MC-NINT2x | –                  | –                  | –                  |
| 3.0 V          | S-8357B30MC-NIPT2x | S-8357B30MA-NIPT2G | –                  | S-8357E30MC-NKPT2x |
| 3.3 V          | S-8357B33MC-NIST2x | S-8357B33MA-NIST2G | S-8357B33UA-NIST2x | –                  |
| 3.6 V          | S-8357B36MC-NIVT2x | –                  | –                  | –                  |
| 3.8 V          | –                  | –                  | S-8357B38UA-NIXT2x | –                  |
| 4.0 V          | S-8357B40MC-NIZT2x | –                  | –                  | –                  |
| 4.8 V          | S-8357B48MC-NJHT2x | –                  | S-8357B48UA-NJHT2x | –                  |
| 5.0 V          | S-8357B50MC-NJJT2x | S-8357B50MA-NJJT2G | S-8357B50UA-NJJT2x | S-8357E50MC-NLJT2x |
| 5.2 V          | S-8357B52MC-NJLT2x | –                  | –                  | –                  |
| 5.4 V          | S-8357B54MC-NJNT2x | –                  | –                  | –                  |
| 6.0 V          | S-8357B60MC-NJTT2x | –                  | –                  | –                  |

Table 7

| Output voltage | S-8357FxxMC Series | S-8357GxxMC Series | S-8357HxxMC Series | S-8357JxxMC Series |
|----------------|--------------------|--------------------|--------------------|--------------------|
| 2.0 V          | –                  | –                  | –                  | S-8357J20MC-NOFT2x |
| 2.5 V          | –                  | –                  | –                  | S-8357J25MC-NOKT2x |
| 3.0 V          | S-8357F30MC-MGPT2x | –                  | S-8357H30MC-NMPT2G | –                  |
| 3.1 V          | –                  | –                  | S-8357H31MC-NMQT2G | –                  |
| 3.2 V          | S-8357F32MC-MGRT2x | S-8357G32MC-MIRT2x | –                  | –                  |
| 3.3 V          | S-8357F33MC-MGST2x | S-8357G33MC-MIST2x | –                  | –                  |
| 3.5 V          | –                  | –                  | S-8357H35MC-NMUT2x | –                  |
| 3.6 V          | S-8357F36MC-MGVT2x | –                  | S-8357H36MC-NMVT2x | –                  |
| 4.2 V          | –                  | –                  | S-8357H42MC-NNBT2x | –                  |
| 5.0 V          | S-8357F50MC-MHJT2x | S-8357G50MC-MJJT2x | S-8357H50MC-NNJT2x | S-8357J50MC-NPJT2x |
| 5.2 V          | S-8357F52MC-MHLT2x | –                  | S-8357H52MC-NNLT2x | –                  |
| 6.5 V          | S-8357F65MC-MHYT2x | –                  | –                  | –                  |

Table 8

| Output voltage | S-8357NxxMC Series |
|----------------|--------------------|
| 3.0 V          | S-8357N30MC-O2PT2x |
| 3.3 V          | S-8357N33MC-O2ST2x |
| 5.0 V          | S-8357N50MC-O3JT2x |
| 5.3 V          | S-8357N53MC-O3MT2U |

**Remark 1.** Please contact the ABLIC Inc. marketing department for products with an output voltage other than those specified above.

2. x: G or U

3. Please select products of environmental code = U for Sn 100%, halogen-free products.



(4) S-8358 Series

Table 9

| Output voltage | S-8358BxxMC Series | S-8358BxxMA Series | S-8358BxxUA Series | S-8358ExxMC Series |
|----------------|--------------------|--------------------|--------------------|--------------------|
| 2.0 V          | –                  | –                  | –                  | S-8358E20MC-NSFT2x |
| 2.3 V          | S-8358B23MC-NQIT2x | –                  | –                  | –                  |
| 2.5 V          | S-8358B25MC-NQKT2x | –                  | –                  | –                  |
| 2.6 V          | S-8358B26MC-NQLT2x | –                  | –                  | –                  |
| 2.7 V          | S-8358B27MC-NQMT2x | –                  | –                  | –                  |
| 2.8 V          | S-8358B28MC-NQNT2x | –                  | –                  | –                  |
| 3.0 V          | S-8358B30MC-NQPT2x | S-8358B30MA-NQPT2G | –                  | –                  |
| 3.1 V          | S-8358B31MC-NQQT2x | –                  | –                  | –                  |
| 3.2 V          | S-8358B32MC-NQRT2x | –                  | –                  | –                  |
| 3.3 V          | S-8358B33MC-NQST2x | –                  | S-8358B33UA-NQST2x | –                  |
| 3.5 V          | S-8358B35MC-NQUT2x | –                  | –                  | –                  |
| 3.6 V          | S-8358B36MC-NQVT2x | –                  | –                  | –                  |
| 3.8 V          | S-8358B38MC-NQXT2x | –                  | –                  | –                  |
| 4.0 V          | S-8358B40MC-NQZT2x | –                  | –                  | –                  |
| 5.0 V          | S-8358B50MC-NRJT2x | S-8358B50MA-NRJT2G | S-8358B50UA-NRJT2x | S-8358E50MC-NTJT2x |
| 5.3 V          | S-8358B53MC-NRMT2x | –                  | –                  | –                  |
| 6.0 V          | S-8358B60MC-NRTT2x | –                  | S-8358B60UA-NRTT2x | –                  |

Table 10

| Output voltage | S-8358FxxMC Series | S-8358GxxMC Series | S-8358HxxMC Series | S-8358JxxMC Series |
|----------------|--------------------|--------------------|--------------------|--------------------|
| 2.3 V          | –                  | –                  | S-8358H23MC-NUIT2x | –                  |
| 2.6 V          | S-8358F26MC-MKLT2x | –                  | –                  | –                  |
| 2.7 V          | S-8358F27MC-MKMT2x | –                  | –                  | –                  |
| 3.0 V          | S-8358F30MC-MKPT2x | –                  | S-8358H30MC-NUPT2x | –                  |
| 3.2 V          | –                  | –                  | S-8358H32MC-NURT2x | –                  |
| 3.3 V          | S-8358F33MC-MKST2x | –                  | S-8358H33MC-NUST2x | S-8358J33MC-NWST2x |
| 3.6 V          | S-8358F36MC-MKVT2x | –                  | –                  | –                  |
| 4.0 V          | –                  | –                  | S-8358H40MC-NUZT2x | –                  |
| 5.0 V          | S-8358F50MC-MLJT2x | S-8358G50MC-MNJT2x | S-8358H50MC-NVJT2x | S-8358J50MC-NXJT2x |
| 5.3 V          | S-8358F53MC-MLMT2x | –                  | –                  | –                  |
| 5.7 V          | S-8358F57MC-MLQT2x | –                  | –                  | –                  |
| 6.0 V          | S-8358F60MC-MLTT2x | –                  | –                  | –                  |

Table 11

| Output voltage | S-8358NxxMC Series | S-8358PxxMC Series |
|----------------|--------------------|--------------------|
| 2.0 V          | –                  | S-8358P20MC-O8FT2x |
| 3.0 V          | S-8358N30MC-O6PT2x | –                  |
| 3.3 V          | S-8358N33MC-O6ST2x | –                  |
| 5.0 V          | S-8358N50MC-O7JT2x | –                  |
| 5.2 V          | –                  | S-8358P52MC-O9LT2x |
| 5.3 V          | S-8358N53MC-O7MT2x | –                  |

**Remark 1.** Please contact the ABLIC Inc. marketing department for products with an output voltage other than those specified above.

2. x: G or U

3. Please select products of environmental code = U for Sn 100%, halogen-free products.

■ Pin Configurations

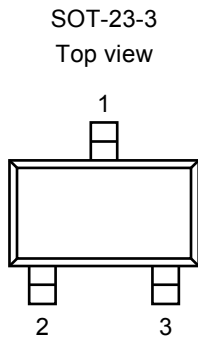

Figure 5

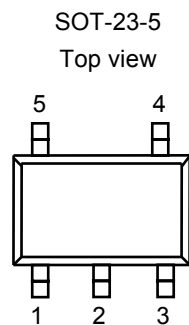

Figure 6

**Table 12 S-8357/58 Series B, H and F Types**  
 (Without shutdown function,  $V_{DD}$  /  $V_{OUT}$  non-separate type)

| Pin No. | Symbol | Pin Description                            |
|---------|--------|--|
| 1       | VOUT   | Output voltage pin and IC power supply pin |
| 2       | VSS    | GND pin                                    |
| 3       | EXT    | External transistor connection pin         |

**Table 13 S-8355/56 Series K, L, M and Q Types**  
 (With shutdown function,  $V_{DD}$  /  $V_{OUT}$  separate type)

| Pin No. | Symbol                      | Pin Description  |
|---------|-----------------------------|--|
| 1       | VOUT                        | Output voltage   |
| 2       | VDD                         | IC power supply pin  |
| 3       | ON/ $\overline{\text{OFF}}$ | Shutdown pin<br>"H": Normal operation (Step-up operating)<br>"L": Step-up stopped (Entire circuit stopped) |
| 4       | VSS                         | GND pin  |
| 5       | EXT                         | External transistor connection pin   |

**Table 14 S-8357/58 Series B, H, F and N Types**  
 (With shutdown function,  $V_{DD}$  /  $V_{OUT}$  non-separate type)

| Pin No. | Symbol                      | Pin Description  |
|---------|-----------------------------|--|
| 1       | ON/ $\overline{\text{OFF}}$ | Shutdown pin<br>"H": Normal operation (Step-up operating)<br>"L": Step-up stopped (Entire circuit stopped) |
| 2       | VOUT                        | Output voltage pin and IC power supply pin   |
| 3       | NC*1                        | No connection  |
| 4       | VSS                         | GND pin  |
| 5       | EXT                         | External transistor connection pin   |

\*1. The NC pin indicates electrically open.

**Table 15 S-8357/58 Series E, J, G and P Types**  
 (Without shutdown function,  $V_{DD}$  /  $V_{OUT}$  separate type)

| Pin No. | Symbol | Pin Description                    |
|---------|--------|------------------------------------|
| 1       | VOUT   | Output voltage pin                 |
| 2       | VDD    | IC power supply pin                |
| 3       | NC*1   | No connection                      |
| 4       | VSS    | GND pin                            |
| 5       | EXT    | External transistor connection pin |

\*1. The NC pin indicates electrically open.

SOT-89-3  
 Top view



Figure 7

**Table 16 S-8357/58 Series B, H and F Types**  
 (Without shutdown function,  $V_{DD}$  /  $V_{OUT}$  non-separate type)

| Pin No. | Symbol | Pin Description                            |
|---------|--------|--|
| 1       | VSS    | GND pin                                    |
| 2       | VOUT   | Output voltage pin and IC power supply pin |
| 3       | EXT    | External transistor connection pin         |

■ **Absolute Maximum Ratings**

Table 17

(Ta = 25°C unless otherwise specified)

| Item                           | Symbol                          | Absolute maximum rating                         | Unit |
|--------------------------------|---------------------------------|---|------|
| V <sub>OUT</sub> pin voltage   | V <sub>OUT</sub>                | V <sub>SS</sub> - 0.3 to V <sub>SS</sub> + 12   | V    |
| ON/OFF pin voltage *1          | V <sub>ON/OFF</sub>             | V <sub>SS</sub> - 0.3 to V <sub>SS</sub> + 12   | V    |
| V <sub>DD</sub> pin voltage *2 | V <sub>DD</sub>                 | V <sub>SS</sub> - 0.3 to V <sub>SS</sub> + 12   | V    |
| EXT pin voltage                | B, H, F, N type                 | V <sub>SS</sub> - 0.3 to V <sub>OUT</sub> + 0.3 | V    |
|                                | Others                          | V <sub>SS</sub> - 0.3 to V <sub>DD</sub> + 0.3  | V    |
| EXT pin current                | I <sub>EXT</sub>                | ±80   | mA   |
| Power dissipation              | SOT-23-3                        | 150 (When not mounted on board)                 | mW   |
|                                |                                 | 430*3   | mW   |
|                                |                                 | 250 (When not mounted on board)                 | mW   |
|                                |                                 | 600*3   | mW   |
| SOT-23-5                       | 500 (When not mounted on board) | mW  |      |
|                                | 1000*3                          | mW  |      |
| SOT-89-3                       |                                 |   |      |
| Operating ambient temperature  | T <sub>opr</sub>                | -40 to +85                                      | °C   |
| Storage temperature            | T <sub>stg</sub>                | -40 to +125                                     | °C   |

\*1. With shutdown function

\*2. For V<sub>DD</sub> / V<sub>OUT</sub> separate type

\*3. When mounted on board

**[Mounted board]**

(1) Board size : 114.3 mm × 76.2 mm × t1.6 mm

(2) Name : JEDEC STANDARD51-7

**Caution** The absolute maximum ratings are rated values exceeding which the product could suffer physical damage. These values must therefore not be exceeded under any conditions.

(1) When mounted on board



(2) When not mounted on board



Figure 8 Power Dissipation of The Package

■ Electrical Characteristics

(1) 100 kHz Product (B, E and K Types)

Table 18 (1 / 2)

(Ta = 25°C unless otherwise specified)

| Item  | Symbol  | Condition   | Min.                        | Typ.                | Max.                        | Unit     | Measurement circuit |   |
|---|---|---|-----------------------------|---------------------|-----------------------------|----------|---------------------|---|
| Output voltage  | V <sub>OUT</sub>                                    | –   | V <sub>OUT(S)</sub> × 0.976 | V <sub>OUT(S)</sub> | V <sub>OUT(S)</sub> × 1.024 | V        | 2                   |   |
| Input voltage   | V <sub>IN</sub>                                     | –   | –                           | –                   | 10                          | V        | 2                   |   |
| Operation start voltage   | V <sub>ST1</sub>                                    | I <sub>OUT</sub> = 1 mA   | –                           | –                   | 0.9                         | V        | 2                   |   |
| Oscillation start voltage                                       | V <sub>ST2</sub>                                    | No external parts, Voltage applied to V <sub>OUT</sub>                          | –                           | –                   | 0.8                         | V        | 1                   |   |
| Operation holding voltage                                       | V <sub>HLD</sub>                                    | I <sub>OUT</sub> = 1 mA, Judged by decreasing V <sub>IN</sub> voltage gradually | 0.7                         | –                   | –                           | V        | 2                   |   |
| Current consumption 1   | I <sub>SS1</sub>                                    | V <sub>OUT</sub> = V <sub>OUT(S)</sub> × 0.95                                   | S-835xx15 to 19             | –                   | 14.0                        | 23.4     | μA                  | 1 |
|   |   |   | S-835xx20 to 29             | –                   | 19.7                        | 32.9     | μA                  | 1 |
|   |   |   | S-835xx30 to 39             | –                   | 25.9                        | 43.2     | μA                  | 1 |
|   |   |   | S-835xx40 to 49             | –                   | 32.6                        | 54.4     | μA                  | 1 |
|   |   |   | S-835xx50 to 59             | –                   | 39.8                        | 66.4     | μA                  | 1 |
| Current consumption 2   | I <sub>SS2</sub>                                    | V <sub>OUT</sub> = V <sub>OUT(S)</sub> + 0.5 V                                  | S-835xx15 to 19             | –                   | 5.6                         | 11.1     | μA                  | 1 |
|   |   |   | S-835xx20 to 29             | –                   | 5.8                         | 11.5     | μA                  | 1 |
|   |   |   | S-835xx30 to 39             | –                   | 5.9                         | 11.8     | μA                  | 1 |
|   |   |   | S-835xx40 to 49             | –                   | 6.1                         | 12.1     | μA                  | 1 |
|   |   |   | S-835xx50 to 59             | –                   | 6.3                         | 12.5     | μA                  | 1 |
| Current consumption during shutdown<br>(With shutdown function) | I <sub>SSS</sub>                                    | V <sub>ON/OFF</sub> = 0 V   | –                           | –                   | 0.5                         | μA       | 1                   |   |
|   |   |   | –                           | –                   | 0.5                         | μA       | 1                   |   |
| EXT pin output current  | I <sub>EXTH</sub>                                   | V <sub>EXT</sub> = V <sub>OUT</sub> – 0.4 V                                     | S-835xx15 to 19             | –4.5                | –8.9                        | –        | mA                  | 1 |
|   |   |   | S-835xx20 to 24             | –6.2                | –12.3                       | –        | mA                  | 1 |
|   |   |   | S-835xx25 to 29             | –7.8                | –15.7                       | –        | mA                  | 1 |
|   |   |   | S-835xx30 to 39             | –10.3               | –20.7                       | –        | mA                  | 1 |
|   |   |   | S-835xx40 to 49             | –13.3               | –26.7                       | –        | mA                  | 1 |
|   |   |   | S-835xx50 to 59             | –16.1               | –32.3                       | –        | mA                  | 1 |
|   | I <sub>EXTL</sub>                                   | V <sub>EXT</sub> = 0.4 V  | S-835xx15 to 19             | 9.5                 | 19.0                        | –        | mA                  | 1 |
|   |   |   | S-835xx20 to 24             | 12.6                | 25.2                        | –        | mA                  | 1 |
|   |   |   | S-835xx25 to 29             | 15.5                | 31.0                        | –        | mA                  | 1 |
|   |   |   | S-835xx30 to 39             | 19.2                | 38.5                        | –        | mA                  | 1 |
|   |   |   | S-835xx40 to 49             | 23.8                | 47.6                        | –        | mA                  | 1 |
|   |   |   | S-835xx50 to 59             | 27.4                | 54.8                        | –        | mA                  | 1 |
|   |   |   | S-835xx60 to 65             | 30.3                | 60.6                        | –        | mA                  | 1 |
| Line regulation   | ΔV <sub>OUT1</sub>                                  | V <sub>IN</sub> = V <sub>OUT(S)</sub> × 0.4 to × 0.6                            | –                           | 30                  | 60                          | mV       | 2                   |   |
| Load regulation   | ΔV <sub>OUT2</sub>                                  | I <sub>OUT</sub> = 10 μA to V <sub>OUT(S)</sub> / 50 × 1.25                     | –                           | 30                  | 60                          | mV       | 2                   |   |
| Output voltage temperature coefficient                          | $\frac{\Delta V_{OUT}}{\Delta T_a \bullet V_{OUT}}$ | Ta = –40 to +85°C   | –                           | ±50                 | –                           | ppm / °C | 2                   |   |
| Oscillation frequency   | f <sub>OSC</sub>                                    | V <sub>OUT</sub> = V <sub>OUT(S)</sub> × 0.95                                   | 85                          | 100                 | 115                         | kHz      | 1                   |   |
| Maximum duty ratio  | MaxDuty   | V <sub>OUT</sub> = V <sub>OUT(S)</sub> × 0.95                                   | 75                          | 83                  | 90                          | %        | 1                   |   |
| PWM / PFM switching duty ratio<br>(For S-8356/58 Series)        | PFMDuty   | V <sub>IN</sub> = V <sub>OUT(S)</sub> – 0.1 V, No-load                          | 10                          | 15                  | 24                          | %        | 1                   |   |
| ON / OFF pin input voltage<br>(With shutdown function)          | V <sub>SH</sub>                                     | Measured oscillation at EXT pin   | 0.75                        | –                   | –                           | V        | 1                   |   |
|   | V <sub>SL1</sub>                                    | Judged oscillation stop at<br>EXT pin   | At V <sub>OUT</sub> ≥ 1.5 V | –                   | –                           | 0.3      | V                   | 1 |
|   |   |   | At V <sub>OUT</sub> < 1.5 V | –                   | –                           | 0.2      | V                   | 1 |

**Table 18 (2 / 2)**

(Ta = 25°C unless otherwise specified)

| Item   | Symbol          | Condition  | Min. | Typ. | Max. | Unit | Measurement circuit |
|--|-----------------|--|------|------|------|------|---------------------|
| ON / OFF pin input current<br>(For with shutdown function) | I <sub>SH</sub> | V <sub>ON/OFF</sub> = V <sub>OUT(S)</sub> × 0.95 | -0.1 | -    | 0.1  | μA   | 1                   |
|  | I <sub>SL</sub> | V <sub>ON/OFF</sub> = 0 V                        | -0.1 | -    | 0.1  | μA   | 1                   |
| Soft start time  | t <sub>SS</sub> | -  | 3.0  | 6.0  | 12.0 | ms   | 2                   |
| Efficiency   | EFFI            | -  | -    | 85   | -    | %    | 2                   |

External parts

Coil: CDRH6D28-470 of Sumida Corporation  
 Diode: RB461F (Schottky type) of Rohm Co., Ltd.  
 Capacitor: F93 (16 V, 47 μF tantalum type) of Nichicon Corporation  
 Transistor: CPH3210 of Sanyo Electric Co., Ltd.  
 Base resistor (R<sub>b</sub>): 1.0 kΩ  
 Base capacitor (C<sub>b</sub>): 2200 pF (ceramic type)

V<sub>IN</sub> = V<sub>OUT(S)</sub> × 0.6 applied, I<sub>OUT</sub> = V<sub>OUT(S)</sub> / 50 Ω

With shutdown function : ON / OFF pin is connected to V<sub>OUT</sub>

For V<sub>DD</sub> / V<sub>OUT</sub> separate type : VDD pin is connected to V<sub>OUT</sub> pin

- Remark**
1. V<sub>OUT(S)</sub> specified above is the set output voltage value, and V<sub>OUT</sub> is the typical value of the actual output voltage.
  2. V<sub>DD</sub> / V<sub>OUT</sub> separate type  
 A step-up operation is performed from V<sub>DD</sub> = 0.8 V. However, 1.8 V ≤ V<sub>DD</sub> ≤ 10 V is recommended stabilizing the output voltage and oscillation frequency. (V<sub>DD</sub> ≥ 1.8 V must be applied for products with a set value of less than 1.9 V.)

(2) 250 kHz Product (H, J and L Types)

Table 19

(Ta = 25°C unless otherwise specified)

| Item   | Symbol  | Condition  | Min.                            | Typ.         | Max.                      | Unit          | Measurement circuit |   |
|--|---|--|---------------------------------|--------------|---------------------------|---------------|---------------------|---|
| Output voltage   | $V_{OUT}$   | –  | $V_{OUT(S)} \times 0.976$       | $V_{OUT(S)}$ | $V_{OUT(S)} \times 1.024$ | V             | 2                   |   |
| Input voltage  | $V_{IN}$  | –  | –                               | –            | 10                        | V             | 2                   |   |
| Operation start voltage                                      | $V_{ST1}$   | $I_{OUT} = 1 \text{ mA}$   | –                               | –            | 0.9                       | V             | 2                   |   |
| Oscillation start voltage                                    | $V_{ST2}$   | No external parts, Voltage applied to $V_{OUT}$                            | –                               | –            | 0.8                       | V             | 1                   |   |
| Operation holding voltage                                    | $V_{HLD}$   | $I_{OUT} = 1 \text{ mA}$ , Judged by decreasing $V_{IN}$ voltage gradually | 0.7                             | –            | –                         | V             | 2                   |   |
| Current consumption 1  | $I_{SS1}$   | $V_{OUT} = V_{OUT(S)} \times 0.95$   | S-835xx15 to 19                 | –            | 28.9                      | 48.2          | $\mu\text{A}$       | 1 |
|  |   |  | S-835xx20 to 29                 | –            | 42.7                      | 71.1          | $\mu\text{A}$       | 1 |
|  |   |  | S-835xx30 to 39                 | –            | 58.0                      | 96.7          | $\mu\text{A}$       | 1 |
|  |   |  | S-835xx40 to 49                 | –            | 74.5                      | 124.1         | $\mu\text{A}$       | 1 |
|  |   |  | S-835xx50 to 59                 | –            | 92.0                      | 153.4         | $\mu\text{A}$       | 1 |
|  |   |  | S-835xx60 to 65                 | –            | 110.5                     | 184.2         | $\mu\text{A}$       | 1 |
| Current consumption 2  | $I_{SS2}$   | $V_{OUT} = V_{OUT(S)} + 0.5 \text{ V}$                                     | S-835xx15 to 19                 | –            | 8.7                       | 17.3          | $\mu\text{A}$       | 1 |
|  |   |  | S-835xx20 to 29                 | –            | 8.8                       | 17.6          | $\mu\text{A}$       | 1 |
|  |   |  | S-835xx30 to 39                 | –            | 9.0                       | 18.0          | $\mu\text{A}$       | 1 |
|  |   |  | S-835xx40 to 49                 | –            | 9.2                       | 18.3          | $\mu\text{A}$       | 1 |
|  |   |  | S-835xx50 to 59                 | –            | 9.3                       | 18.6          | $\mu\text{A}$       | 1 |
|  |   |  | S-835xx60 to 65                 | –            | 9.5                       | 19.0          | $\mu\text{A}$       | 1 |
| Current consumption during shutdown (With shutdown function) | $I_{SS3}$   | $V_{ON/OFF} = 0 \text{ V}$   | –                               | –            | 0.5                       | $\mu\text{A}$ | 1                   |   |
| EXT pin output current                                       | $I_{EXTH}$  | $V_{EXT} = V_{OUT} - 0.4 \text{ V}$  | S-835xx15 to 19                 | –4.5         | –8.9                      | –             | mA                  | 1 |
|  |   |  | S-835xx20 to 24                 | –6.2         | –12.3                     | –             | mA                  | 1 |
|  |   |  | S-835xx25 to 29                 | –7.8         | –15.7                     | –             | mA                  | 1 |
|  |   |  | S-835xx30 to 39                 | –10.3        | –20.7                     | –             | mA                  | 1 |
|  |   |  | S-835xx40 to 49                 | –13.3        | –26.7                     | –             | mA                  | 1 |
|  |   |  | S-835xx50 to 59                 | –16.1        | –32.3                     | –             | mA                  | 1 |
|  |   |  | S-835xx60 to 65                 | –18.9        | –37.7                     | –             | mA                  | 1 |
|  | $I_{EXTL}$  | $V_{EXT} = 0.4 \text{ V}$  | S-835xx15 to 19                 | 9.5          | 19.0                      | –             | mA                  | 1 |
|  |   |  | S-835xx20 to 24                 | 12.6         | 25.2                      | –             | mA                  | 1 |
|  |   |  | S-835xx25 to 29                 | 15.5         | 31.0                      | –             | mA                  | 1 |
|  |   |  | S-835xx30 to 39                 | 19.2         | 38.5                      | –             | mA                  | 1 |
|  |   |  | S-835xx40 to 49                 | 23.8         | 47.6                      | –             | mA                  | 1 |
|  |   |  | S-835xx50 to 59                 | 27.4         | 54.8                      | –             | mA                  | 1 |
|  |   |  | S-835xx60 to 65                 | 30.3         | 60.6                      | –             | mA                  | 1 |
| Line regulation  | $\Delta V_{OUT1}$                                   | $V_{IN} = V_{OUT(S)} \times 0.4 \text{ to } \times 0.6$                    | –                               | 30           | 60                        | mV            | 2                   |   |
| Load regulation  | $\Delta V_{OUT2}$                                   | $I_{OUT} = 10 \mu\text{A to } V_{OUT(S)} / 50 \times 1.25$                 | –                               | 30           | 60                        | mV            | 2                   |   |
| Output voltage temperature coefficient                       | $\frac{\Delta V_{OUT}}{\Delta T_a \bullet V_{OUT}}$ | $T_a = -40 \text{ to } +85^\circ\text{C}$                                  | –                               | $\pm 50$     | –                         | ppm / °C      | 2                   |   |
| Oscillation frequency  | $f_{OSC}$   | $V_{OUT} = V_{OUT(S)} \times 0.95$   | 212.5                           | 250          | 287.5                     | kHz           | 1                   |   |
| Maximum duty ratio   | MaxDuty   | $V_{OUT} = V_{OUT(S)} \times 0.95$   | 70                              | 78           | 85                        | %             | 1                   |   |
| PWM / PFM switching duty ratio (For S-8356/58 Series)        | PFMDuty   | $V_{IN} = V_{OUT(S)} - 0.1 \text{ V}$ , No-load                            | 10                              | 15           | 24                        | %             | 1                   |   |
| ON / OFF pin input voltage (With shutdown function)          | $V_{SH}$  | Measured oscillation at EXT pin  | 0.75                            | –            | –                         | V             | 1                   |   |
|  | $V_{SL1}$   | Judged oscillation stop at EXT pin   | At $V_{OUT} \geq 1.5 \text{ V}$ | –            | –                         | 0.3           | V                   | 1 |
|  | $V_{SL2}$   |  | At $V_{OUT} < 1.5 \text{ V}$    | –            | –                         | 0.2           | V                   | 1 |
| ON / OFF pin input current (With shutdown function)          | $I_{SH}$  | $V_{ON/OFF} = V_{OUT(S)} \times 0.95$                                      | –0.1                            | –            | 0.1                       | $\mu\text{A}$ | 1                   |   |
|  | $I_{SL}$  | $V_{ON/OFF} = 0 \text{ V}$   | –0.1                            | –            | 0.1                       | $\mu\text{A}$ | 1                   |   |
| Soft start time  | $t_{SS}$  | –  | 1.5                             | 3.0          | 6.0                       | ms            | 2                   |   |
| Efficiency   | EFFI  | –  | –                               | 85           | –                         | %             | 2                   |   |

External parts

|                           |  |
|---------------------------|--|
| Coil:                     | CDRH6D28-220 of Sumida Corporation                           |
| Diode:                    | RB461F (Schottky type) of Rohm Co., Ltd.                     |
| Capacitor:                | F93 (16 V, 47 $\mu$ F tantalum type) of Nichicon Corporation |
| Transistor:               | CPH3210 of Sanyo Electric Co., Ltd.                          |
| Base resistor ( $R_b$ ):  | 1.0 k $\Omega$   |
| Base capacitor ( $C_b$ ): | 2200 pF (ceramic type)                                       |

$V_{IN} = V_{OUT(S)} \times 0.6$  applied,  $I_{OUT} = V_{OUT(S)} / 50 \Omega$

With shutdown function : ON/ $\overline{\text{OFF}}$  pin is connected to  $V_{OUT}$

For  $V_{DD} / V_{OUT}$  separate type :  $V_{DD}$  pin is connected to  $V_{OUT}$  pin

- Remark**
1.  $V_{OUT(S)}$  specified above is the set output voltage value, and  $V_{OUT}$  is the typical value of the actual output voltage.
  2.  $V_{DD} / V_{OUT}$  separate type  
A step-up operation is performed from  $V_{DD} = 0.8$  V. However,  $1.8 \text{ V} \leq V_{DD} \leq 10 \text{ V}$  is recommended stabilizing the output voltage and oscillation frequency. ( $V_{DD} \geq 1.8 \text{ V}$  must be applied for products with a set value of less than 1.9 V.)



(3) 300 kHz Product (F, G and M Types)

Table 20

(Ta = 25°C unless otherwise specified)

| Item   | Symbol  | Condition  | Min.                            | Typ.              | Max.  | Unit          | Measurement circuit |    |
|--|---|--|---------------------------------|-------------------|---|---------------|---------------------|----|
| Output voltage   | $V_{OUT}$   | –  | $V_{OUT(S)} \times 0.976$       | $V_{OUT(S)}$      | $V_{OUT(S)} \times 1.024$                               | V             | 2                   |    |
| Input voltage  | $V_{IN}$  | –  | –                               | –                 | 10  | V             | 2                   |    |
| Operation start voltage                                      | $V_{ST1}$   | $I_{OUT} = 1 \text{ mA}$   | –                               | –                 | 0.9   | V             | 2                   |    |
| Oscillation start voltage                                    | $V_{ST2}$   | No external parts, Voltage applied to $V_{OUT}$                            | –                               | –                 | 0.8   | V             | 1                   |    |
| Operation holding voltage                                    | $V_{HLD}$   | $I_{OUT} = 1 \text{ mA}$ , Judged by decreasing $V_{IN}$ voltage gradually | 0.7                             | –                 | –   | V             | 2                   |    |
| Current consumption 1  | $I_{SS1}$   | $V_{OUT} = V_{OUT(S)} \times 0.95$   | S-835xx15 to 19                 | –                 | 33.8  | 56.4          | $\mu\text{A}$       | 1  |
|  |   |  | S-835xx20 to 29                 | –                 | 50.3  | 83.9          | $\mu\text{A}$       | 1  |
|  |   |  | S-835xx30 to 39                 | –                 | 68.6  | 114.4         | $\mu\text{A}$       | 1  |
|  |   |  | S-835xx40 to 49                 | –                 | 88.4  | 147.4         | $\mu\text{A}$       | 1  |
|  |   |  | S-835xx50 to 59                 | –                 | 109.4   | 182.4         | $\mu\text{A}$       | 1  |
|  |   |  | S-835xx60 to 65                 | –                 | 131.6   | 219.3         | $\mu\text{A}$       | 1  |
| Current consumption 2  | $I_{SS2}$   | $V_{OUT} = V_{OUT(S)} + 0.5 \text{ V}$                                     | S-835xx15 to 19                 | –                 | 9.7   | 19.4          | $\mu\text{A}$       | 1  |
|  |   |  | S-835xx20 to 29                 | –                 | 9.9   | 19.7          | $\mu\text{A}$       | 1  |
|  |   |  | S-835xx30 to 39                 | –                 | 10.0  | 20.0          | $\mu\text{A}$       | 1  |
|  |   |  | S-835xx40 to 49                 | –                 | 10.2  | 20.4          | $\mu\text{A}$       | 1  |
|  |   |  | S-835xx50 to 59                 | –                 | 10.4  | 20.7          | $\mu\text{A}$       | 1  |
|  |   |  | S-835xx60 to 65                 | –                 | 10.5  | 21.0          | $\mu\text{A}$       | 1  |
| Current consumption during shutdown (With shutdown function) | $I_{SSS}$   | $V_{ON/OFF} = 0 \text{ V}$   | –                               | –                 | 0.5   | $\mu\text{A}$ | 1                   |    |
| EXT pin output current                                       | $I_{EXTH}$  | $V_{EXT} = V_{OUT} - 0.4 \text{ V}$  | S-835xx15 to 19                 | –4.5              | –8.9  | –             | mA                  | 1  |
|  |   |  | S-835xx20 to 24                 | –6.2              | –12.3   | –             | mA                  | 1  |
|  |   |  | S-835xx25 to 29                 | –7.8              | –15.7   | –             | mA                  | 1  |
|  |   |  | S-835xx30 to 39                 | –10.3             | –20.7   | –             | mA                  | 1  |
|  |   |  | S-835xx40 to 49                 | –13.3             | –26.7   | –             | mA                  | 1  |
|  |   |  | S-835xx50 to 59                 | –16.1             | –32.3   | –             | mA                  | 1  |
|  | $I_{EXTL}$  | $V_{EXT} = 0.4 \text{ V}$  | S-835xx15 to 19                 | 9.5               | 19.0  | –             | mA                  | 1  |
|  |   |  | S-835xx20 to 24                 | 12.6              | 25.2  | –             | mA                  | 1  |
|  |   |  | S-835xx25 to 29                 | 15.5              | 31.0  | –             | mA                  | 1  |
|  |   |  | S-835xx30 to 39                 | 19.2              | 38.5  | –             | mA                  | 1  |
|  |   |  | S-835xx40 to 49                 | 23.8              | 47.6  | –             | mA                  | 1  |
|  |   |  | S-835xx50 to 59                 | 27.4              | 54.8  | –             | mA                  | 1  |
|  |   |  | S-835xx60 to 65                 | 30.3              | 60.6  | –             | mA                  | 1  |
|  |   |  | Line regulation                 | $\Delta V_{OUT1}$ | $V_{IN} = V_{OUT(S)} \times 0.4 \text{ to } \times 0.6$ | –             | 30                  | 60 |
| Load regulation  | $\Delta V_{OUT2}$                                   | $I_{OUT} = 10 \mu\text{A to } V_{OUT(S)} / 50 \times 1.25$                 | –                               | 30                | 60  | mV            | 2                   |    |
| Output voltage temperature coefficient                       | $\frac{\Delta V_{OUT}}{\Delta T_a \bullet V_{OUT}}$ | $T_a = -40 \text{ to } +85^\circ\text{C}$                                  | –                               | $\pm 50$          | –   | ppm / °C      | 2                   |    |
| Oscillation frequency  | $f_{OSC}$   | $V_{OUT} = V_{OUT(S)} \times 0.95$   | 255                             | 300               | 345   | kHz           | 1                   |    |
| Maximum duty ratio   | MaxDuty   | $V_{OUT} = V_{OUT(S)} \times 0.95$   | 70                              | 78                | 85  | %             | 1                   |    |
| PWM / PFM switching duty ratio (For S-8356/58 Series)        | PFMDuty   | $V_{IN} = V_{OUT(S)} - 0.1 \text{ V}$ , No-load                            | 10                              | 15                | 24  | %             | 1                   |    |
| ON / OFF pin input voltage (With shutdown function)          | $V_{SH}$  | Measured oscillation at EXT pin  | 0.75                            | –                 | –   | V             | 1                   |    |
|  | $V_{SL1}$   | Judged oscillation stop at EXT pin   | At $V_{OUT} \geq 1.5 \text{ V}$ | –                 | –   | 0.3           | V                   | 1  |
|  | $V_{SL2}$   |  | At $V_{OUT} < 1.5 \text{ V}$    | –                 | –   | 0.2           | V                   | 1  |
| ON / OFF pin input current (With shutdown function)          | $I_{SH}$  | $V_{ON/OFF} = V_{OUT(S)} \times 0.95$                                      | –0.1                            | –                 | 0.1   | $\mu\text{A}$ | 1                   |    |
|  | $I_{SL}$  | $V_{ON/OFF} = 0 \text{ V}$   | –0.1                            | –                 | 0.1   | $\mu\text{A}$ | 1                   |    |
| Soft start time  | $t_{SS}$  | –  | 1.5                             | 3.0               | 6.0   | ms            | 2                   |    |
| Efficiency   | EFFI  | –  | –                               | 85                | –   | %             | 2                   |    |

External parts

|                           |  |
|---------------------------|--|
| Coil:                     | CDRH6D28-220 of Sumida Corporation                           |
| Diode:                    | RB461F (Schottky type) of Rohm Co., Ltd.                     |
| Capacitor:                | F93 (16 V, 47 $\mu$ F tantalum type) of Nichicon Corporation |
| Transistor:               | CPH3210 of Sanyo Electric Co., Ltd.                          |
| Base resistor ( $R_b$ ):  | 1.0 k $\Omega$   |
| Base capacitor ( $C_b$ ): | 2200 pF (ceramic type)                                       |

$V_{IN} = V_{OUT(S)} \times 0.6$  applied,  $I_{OUT} = V_{OUT(S)} / 50 \Omega$

With shutdown function : ON/ $\overline{OFF}$  pin is connected to  $V_{OUT}$

For  $V_{DD}$  /  $V_{OUT}$  separate type :  $V_{DD}$  pin is connected to  $V_{OUT}$  pin

- Remark**
1.  $V_{OUT(S)}$  specified above is the set output voltage value, and  $V_{OUT}$  is the typical value of the actual output voltage.
  2.  $V_{DD}$  /  $V_{OUT}$  separate type  
A step-up operation is performed from  $V_{DD} = 0.8$  V. However,  $1.8 \text{ V} \leq V_{DD} \leq 10 \text{ V}$  is recommended stabilizing the output voltage and oscillation frequency. ( $V_{DD} \geq 1.8 \text{ V}$  must be applied for products with a set value of less than 1.9 V.)

(4) 600 kHz Product (N Type)

Table 21

(Ta = 25°C unless otherwise specified)

| Item  | Symbol  | Condition   | Min.                        | Typ.                | Max.                        | Unit     | Measurement circuit |   |
|---|---|---|-----------------------------|---------------------|-----------------------------|----------|---------------------|---|
| Output voltage  | V <sub>OUT</sub>                                    | –   | V <sub>OUT(S)</sub> × 0.976 | V <sub>OUT(S)</sub> | V <sub>OUT(S)</sub> × 1.024 | V        | 2                   |   |
| Input voltage   | V <sub>IN</sub>                                     | –   | –                           | –                   | 10                          | V        | 2                   |   |
| Operation start voltage                               | V <sub>ST1</sub>                                    | I <sub>OUT</sub> = 1 mA   | –                           | –                   | 0.9                         | V        | 2                   |   |
| Oscillation start voltage                             | V <sub>ST2</sub>                                    | No external parts, Voltage applied to V <sub>OUT</sub>                          | –                           | –                   | 0.8                         | V        | 1                   |   |
| Operation holding voltage                             | V <sub>HLD</sub>                                    | I <sub>OUT</sub> = 1 mA, Judged by decreasing V <sub>IN</sub> voltage gradually | 0.7                         | –                   | –                           | V        | 2                   |   |
| Current consumption 1                                 | I <sub>SS1</sub>                                    | V <sub>OUT</sub> = V <sub>OUT(S)</sub> × 0.95                                   | S-835xx15 to 19             | –                   | 63.6                        | 105.9    | μA                  | 1 |
|   |   |   | S-835xx20 to 29             | –                   | 96.4                        | 160.6    | μA                  | 1 |
|   |   |   | S-835xx30 to 39             | –                   | 132.8                       | 221.3    | μA                  | 1 |
|   |   |   | S-835xx40 to 49             | –                   | 172.2                       | 286.9    | μA                  | 1 |
|   |   |   | S-835xx50 to 59             | –                   | 214.0                       | 356.7    | μA                  | 1 |
| Current consumption 2                                 | I <sub>SS2</sub>                                    | V <sub>OUT</sub> = V <sub>OUT(S)</sub> + 0.5 V                                  | S-835xx15 to 19             | –                   | 15.9                        | 31.8     | μA                  | 1 |
|   |   |   | S-835xx20 to 29             | –                   | 16.1                        | 32.1     | μA                  | 1 |
|   |   |   | S-835xx30 to 39             | –                   | 16.2                        | 32.4     | μA                  | 1 |
|   |   |   | S-835xx40 to 49             | –                   | 16.4                        | 32.8     | μA                  | 1 |
|   |   |   | S-835xx50 to 59             | –                   | 16.6                        | 33.1     | μA                  | 1 |
| Current consumption during shutdown                   | I <sub>SSS</sub>                                    | V <sub>ON/OFF</sub> = 0 V   | –                           | –                   | 0.5                         | μA       | 1                   |   |
|   |   |   | –                           | –                   | 0.5                         | μA       | 1                   |   |
| EXT pin output current                                | I <sub>EXTH</sub>                                   | V <sub>EXT</sub> = V <sub>OUT</sub> – 0.4 V                                     | S-835xx15 to 19             | –4.5                | –8.9                        | –        | mA                  | 1 |
|   |   |   | S-835xx20 to 24             | –6.2                | –12.3                       | –        | mA                  | 1 |
|   |   |   | S-835xx25 to 29             | –7.8                | –15.7                       | –        | mA                  | 1 |
|   |   |   | S-835xx30 to 39             | –10.3               | –20.7                       | –        | mA                  | 1 |
|   |   |   | S-835xx40 to 49             | –13.3               | –26.7                       | –        | mA                  | 1 |
|   |   |   | S-835xx50 to 59             | –16.1               | –32.3                       | –        | mA                  | 1 |
|   |   |   | S-835xx60 to 65             | –18.9               | –37.7                       | –        | mA                  | 1 |
|   | I <sub>EXTL</sub>                                   | V <sub>EXT</sub> = 0.4 V  | S-835xx15 to 19             | 9.5                 | 19.0                        | –        | mA                  | 1 |
|   |   |   | S-835xx20 to 24             | 12.6                | 25.2                        | –        | mA                  | 1 |
|   |   |   | S-835xx25 to 29             | 15.5                | 31.0                        | –        | mA                  | 1 |
|   |   |   | S-835xx30 to 39             | 19.2                | 38.5                        | –        | mA                  | 1 |
|   |   |   | S-835xx40 to 49             | 23.8                | 47.6                        | –        | mA                  | 1 |
|   |   |   | S-835xx50 to 59             | 27.4                | 54.8                        | –        | mA                  | 1 |
|   |   |   | S-835xx60 to 65             | 30.3                | 60.6                        | –        | mA                  | 1 |
| Line regulation                                       | ΔV <sub>OUT1</sub>                                  | V <sub>IN</sub> = V <sub>OUT(S)</sub> × 0.4 to × 0.6                            | –                           | 30                  | 60                          | mV       | 2                   |   |
| Load regulation                                       | ΔV <sub>OUT2</sub>                                  | I <sub>OUT</sub> = 10 μA to V <sub>OUT(S)</sub> / 50 × 1.25                     | –                           | 30                  | 60                          | mV       | 2                   |   |
| Output voltage temperature coefficient                | $\frac{\Delta V_{OUT}}{\Delta T_a \bullet V_{OUT}}$ | Ta = –40 to +85°C   | –                           | ±50                 | –                           | ppm / °C | 2                   |   |
| Oscillation frequency                                 | f <sub>OSC</sub>                                    | V <sub>OUT</sub> = V <sub>OUT(S)</sub> × 0.95                                   | 510                         | 600                 | 690                         | kHz      | 1                   |   |
| Maximum duty ratio                                    | MaxDuty   | V <sub>OUT</sub> = V <sub>OUT(S)</sub> × 0.95                                   | 65                          | 78                  | 85                          | %        | 1                   |   |
| PWM / PFM switching duty ratio (For S-8356/58 Series) | PFMDuty   | V <sub>IN</sub> = V <sub>OUT(S)</sub> – 0.1 V, No-load                          | 10                          | 15                  | 24                          | %        | 1                   |   |
| ON / OFF pin input voltage                            | V <sub>SH</sub>                                     | Measured oscillation at EXT pin   | 0.75                        | –                   | –                           | V        | 1                   |   |
|   | V <sub>SL1</sub>                                    | Judged oscillation stop at EXT pin  | At V <sub>OUT</sub> ≥ 1.5 V | –                   | –                           | 0.3      | V                   | 1 |
|   | V <sub>SL2</sub>                                    | At V <sub>OUT</sub> < 1.5 V   | –                           | –                   | 0.2                         | V        | 1                   |   |
| ON / OFF pin input current                            | I <sub>SH</sub>                                     | V <sub>ON/OFF</sub> = V <sub>OUT(S)</sub> × 0.95                                | –0.1                        | –                   | 0.1                         | μA       | 1                   |   |
|   | I <sub>SL</sub>                                     | V <sub>ON/OFF</sub> = 0 V   | –0.1                        | –                   | 0.1                         | μA       | 1                   |   |
| Soft start time                                       | t <sub>SS</sub>                                     | –   | 1.5                         | 3.0                 | 6.0                         | ms       | 2                   |   |
| Efficiency  | EFFI  | –   | –                           | 85                  | –                           | %        | 2                   |   |

External parts

|                           |  |
|---------------------------|--|
| Coil:                     | CDRH6D28-100 of Sumida Corporation                           |
| Diode:                    | RB461F (Schottky type) of Rohm Co., Ltd.                     |
| Capacitor:                | F93 (16 V, 47 $\mu$ F tantalum type) of Nichicon Corporation |
| Transistor:               | CPH3210 of Sanyo Electric Co., Ltd.                          |
| Base resistor ( $R_b$ ):  | 1.0 k $\Omega$   |
| Base capacitor ( $C_b$ ): | 2200 pF (ceramic type)                                       |

$$V_{IN} = V_{OUT(S)} \times 0.6 \text{ applied, } I_{OUT} = V_{OUT(S)} / 50 \Omega, \text{ ON/OFF} = V_{OUT}$$

**Remark**  $V_{OUT(S)}$  specified above is the set output voltage value, and  $V_{OUT}$  is the typical value of the actual output voltage.

(5) 600 kHz Product (P and Q types)

Table 22

(Ta = 25°C unless otherwise specified)

| Item  | Symbol  | Condition   | Min.                        | Typ.                | Max.                        | Unit     | Measurement circuit |   |
|---|---|---|-----------------------------|---------------------|-----------------------------|----------|---------------------|---|
| Output voltage  | V <sub>OUT</sub>                                    | –   | V <sub>OUT(S)</sub> × 0.976 | V <sub>OUT(S)</sub> | V <sub>OUT(S)</sub> × 1.024 | V        | 4                   |   |
| Input voltage   | V <sub>IN</sub>                                     | –   | –                           | –                   | 10                          | V        | 4                   |   |
| Operation start voltage   | V <sub>ST1</sub>                                    | I <sub>OUT</sub> = 1 mA   | –                           | –                   | 0.9                         | V        | 4                   |   |
| Oscillation start voltage                                       | V <sub>ST2</sub>                                    | No external parts, Voltage applied to V <sub>DD</sub>                           | –                           | –                   | 0.8                         | V        | 3                   |   |
| Operation holding voltage                                       | V <sub>HLD</sub>                                    | I <sub>OUT</sub> = 1 mA, Judged by decreasing V <sub>IN</sub> voltage gradually | 0.7                         | –                   | –                           | V        | 4                   |   |
| Current consumption 1   | I <sub>SS1</sub>                                    | V <sub>DD</sub> = 3.3 V   | –                           | 132.8               | 221.3                       | μA       | 3                   |   |
| Current consumption 2   | I <sub>SS2</sub>                                    | V <sub>DD</sub> = 3.3 V   | –                           | 16.2                | 32.4                        | μA       | 3                   |   |
| Current consumption during shutdown<br>(With shutdown function) | I <sub>SS3</sub>                                    | V <sub>ON/OFF</sub> = 0 V   | –                           | –                   | 0.5                         | μA       | 3                   |   |
| EXT pin output current  | I <sub>EXTH</sub>                                   | V <sub>DD</sub> = 3.3 V   | –10.3                       | –20.7               | –                           | mA       | 3                   |   |
|   | I <sub>EXTL</sub>                                   | V <sub>DD</sub> = 3.3 V   | 19.2                        | 38.5                | –                           | mA       | 3                   |   |
| Line regulation   | ΔV <sub>OUT1</sub>                                  | V <sub>IN</sub> = V <sub>OUT(S)</sub> × 0.4 to × 0.6                            | –                           | 30                  | 60                          | mV       | 4                   |   |
| Load regulation   | ΔV <sub>OUT2</sub>                                  | I <sub>OUT</sub> = 10 μA to V <sub>OUT(S)</sub> / 50 × 1.25                     | –                           | 30                  | 60                          | mV       | 4                   |   |
| Output voltage temperature coefficient                          | $\frac{\Delta V_{OUT}}{\Delta T_a \bullet V_{OUT}}$ | Ta = –40 to +85°C   | –                           | ±50                 | –                           | ppm / °C | 4                   |   |
| Oscillation frequency   | f <sub>OSC</sub>                                    | V <sub>DD</sub> = 3.3 V   | 510                         | 600                 | 690                         | kHz      | 3                   |   |
| Maximum duty ratio  | MaxDuty   | V <sub>DD</sub> = 3.3 V   | 65                          | 78                  | 85                          | %        | 3                   |   |
| PWM / PFM switching duty ratio<br>(For S-8356/58 Series)        | PFMDuty   | V <sub>IN</sub> = V <sub>OUT(S)</sub> – 0.1 V, No-load                          | 10                          | 15                  | 24                          | %        | 3                   |   |
| ON / OFF pin input voltage<br>(With shutdown function)          | V <sub>SH</sub>                                     | Measured oscillation at EXT pin   | 0.75                        | –                   | –                           | V        | 3                   |   |
|   | V <sub>SL1</sub>                                    | Judged oscillation stop at EXT pin  | At V <sub>OUT</sub> ≥ 1.5 V | –                   | –                           | 0.3      | V                   | 3 |
|   | V <sub>SL2</sub>                                    |   | At V <sub>OUT</sub> < 1.5 V | –                   | –                           | 0.2      | V                   | 3 |
| ON / OFF pin input current<br>(With shutdown function)          | I <sub>SH</sub>                                     | V <sub>ON/OFF</sub> = V <sub>OUT(S)</sub> × 0.95                                | –0.1                        | –                   | 0.1                         | μA       | 3                   |   |
|   | I <sub>SL</sub>                                     | V <sub>ON/OFF</sub> = 0 V   | –0.1                        | –                   | 0.1                         | μA       | 3                   |   |
| Soft start time   | t <sub>SS</sub>                                     | –   | 1.5                         | 3.0                 | 6.0                         | ms       | 4                   |   |
| Efficiency  | EFFI  | –   | –                           | 85                  | –                           | %        | 4                   |   |

External parts

Coil: CDRH6D28-100 of Sumida Corporation  
 Diode: RB461F (Schottky type) of Rohm Co., Ltd.  
 Capacitor: F93 (16 V, 47 μF tantalum type) of Nichicon Corporation  
 Transistor: CPH3210 of Sanyo Electric Co., Ltd.  
 Base resistor (R<sub>b</sub>): 1.0 kΩ  
 Base capacitor (C<sub>b</sub>): 2200 pF (ceramic type)

V<sub>IN</sub> = V<sub>OUT(S)</sub> × 0.6 applied, I<sub>OUT</sub> = V<sub>OUT(S)</sub> / 50 Ω, ON / OFF = V<sub>OUT</sub>

- Remark**
1. V<sub>OUT(S)</sub> specified above is the set output voltage value, and V<sub>OUT</sub> is the typical value of the actual output voltage.
  2. V<sub>DD</sub> / V<sub>OUT</sub> separate type  
 A step-up operation is performed from V<sub>DD</sub> = 0.8 V. However, 1.8 V ≤ V<sub>DD</sub> ≤ 10 V is recommended stabilizing the output voltage and oscillation frequency. (V<sub>DD</sub> ≥ 1.8 V must be applied for products with a set value of less than 1.9 V.)

■ **Measurement Circuits**



**Figure 9**



**Figure 10**



**Figure 11**



**Figure 12**

\*1. With shutdown function

\*2. For  $V_{DD}$  /  $V_{OUT}$  separate type

## ■ Operation

### 1. Switching Control Types

#### 1.1 PWM Control (S-8355/57 Series)

The S-8355/57 Series is a DC-DC converter using a pulse width modulation method (PWM) and features a low current consumption.

In conventional PFM DC-DC converters, pulses are skipped when the output load current is low, causing a fluctuation in the ripple frequency of the output voltage, resulting in an increase in the ripple voltage. The switching frequency does not change, although the pulse width changes from 0 to 83% (78% for F, G, H, J, L, M, N, P and Q types) corresponding to each load current. The ripple voltage generated from switching can thus be removed easily through a filter because the switching frequency is constant.

#### 1.2 PWM/PFM Switching Control (S-8356/58 Series)

S-8356/58 Series is a DC-DC converter that automatically switches between a pulse width modulation method (PWM) and a pulse frequency modulation method (PFM), depending on the load current, and features low current consumption.

The S-8356/58 Series operates under PWM control with the pulse width duty changing from 15 to 83% (78% for F, G, H, J, L, M, N, P and Q types) in a high output load current area.

The S-8356/58 Series operates under PFM control with the pulse width duty fixed at 15%, and pulses are skipped according to the load current. The oscillation circuit thus oscillates intermittently so that the resultant lower self current consumption prevents a reduction in the efficiency at a low load current. The switching point from PWM control to PFM control depends on the external devices (coil, diode, etc.), input voltage and output voltage. This series are an especially highly efficient DC-DC converter at an output current around 100  $\mu$ A.

### 2. Soft Start Function

For this IC, the built-in soft start circuit controls the rush current and overshoot of the output voltage when powering on or when the ON/ $\overline{\text{OFF}}$  pin is switched to the "H" level.

**3. ON/OFF Pin (Shutdown Pin) (SOT-23-5 Package Products of S-8355/56/57/58 Series B, H, F, K, L, M, N and Q Types)**

ON/OFF pin stops or starts step-up operation.

Setting the ON/OFF pin to the “L” level stops operation of all the internal circuits and reduces the current consumption significantly.

DO NOT use the ON/OFF pin in a floating state because it has the structure shown in **Figure 13** and is not pulled up or pulled down internally. DO NOT apply a voltage of between 0.3 V and 0.75 V to the ON/OFF pin because applying such a voltage increases the current consumption. If the ON/OFF pin is not used, connect it to the VOUT pin.

The ON/OFF pin does not have hysteresis.

**Table 23**

| ON/OFF pin | CR oscillation circuit | Output voltage      |
|------------|------------------------|---------------------|
| “H”        | Operation              | Fixed               |
| “L”        | Stop                   | $\cong V_{IN}^{*1}$ |

\*1. Voltage obtained by subtracting the voltage drop due to the DC resistance of the inductor and the diode forward voltage from  $V_{IN}$ .



\*1. VDD for K, L, M and Q types.

**Figure 13 ON/OFF Pin Structure**



**4. Operation**

The following are the basic equations [(1) through (7)] of the step-up switching regulator. (Refer to **Figure 14**.)



**Figure 14 Step-Up Switching Regulator Circuit for Basic Equation**

Voltage at CONT pin at the moment M1 is turned ON ( $V_A$ ) \*1 :

$$V_A = V_S \cdot 2 \dots\dots\dots (1)$$

- \*1. Current flowing through L ( $I_L$ ) is zero.
- \*2. Non-saturated voltage of M1.

The change in  $I_L$  over time :

$$\frac{dI_L}{dt} = \frac{V_L}{L} = \frac{V_{IN} - V_S}{L} \dots\dots\dots (2)$$

Integration of equation (2) ( $I_L$ ) :

$$I_L = \left( \frac{V_{IN} - V_S}{L} \right) \cdot t \dots\dots\dots (3)$$

$I_L$  flows while M1 is ON ( $t_{ON}$ ). The time of  $t_{ON}$  is determined by the oscillation frequency of OSC.

The peak current ( $I_{PK}$ ) after  $t_{ON}$  :

$$I_{PK} = \left( \frac{V_{IN} - V_S}{L} \right) \cdot t_{ON} \dots\dots\dots (4)$$

The energy stored in L is represented by  $1/2 \cdot L \cdot (I_{PK})^2$ .

When M1 is turned OFF ( $t_{OFF}$ ), the energy stored in L is emitted through a diode to the output capacitor. Then, the reverse voltage ( $V_L$ ) is generated :

$$V_L = (V_{OUT} + V_D \cdot 1) - V_{IN} \dots\dots\dots (5)$$

- \*1. Diode forward voltage

The voltage at CONT pin rises only by  $V_{OUT} + V_D$ .

The change in the current ( $I_L$ ) flowing through the diode into  $V_{OUT}$  during  $t_{OFF}$  :

$$\frac{dI_L}{dt} = \frac{V_L}{L} = \frac{V_{OUT} + V_D - V_{IN}}{L} \dots\dots\dots (6)$$

Integration of the equation (6) is as follows :

$$I_L = I_{PK} - \left( \frac{V_{OUT} + V_D - V_{IN}}{L} \right) \cdot t \dots\dots\dots (7)$$

During  $t_{ON}$ , the energy is stored in L and is not transmitted to  $V_{OUT}$ . When receiving the output current ( $I_{OUT}$ ) from  $V_{OUT}$ , the energy of the capacitor ( $C_L$ ) is consumed. As a result, the pin voltage of  $C_L$  is reduced, and goes to the lowest level after M1 is turned ON ( $t_{ON}$ ). When M1 is turned OFF, the energy stored in L is transmitted through the diode to  $C_L$ , and the voltage of  $C_L$  rises rapidly.  $V_{OUT}$  is a time function, and therefore indicates the maximum value (ripple voltage ( $V_{P-P}$ )) when the current flowing through into  $V_{OUT}$  and load current ( $I_{OUT}$ ) match.

Next, the ripple voltage is determined as follows.

$I_{OUT}$  vs.  $t_1$  (time) from when M1 is turned OFF (after  $t_{ON}$ ) to when  $V_{OUT}$  reaches the maximum level :

$$I_{OUT} = I_{PK} - \left( \frac{V_{OUT} + V_D - V_{IN}}{L} \right) \cdot t_1 \dots\dots\dots (8)$$

$$\therefore t_1 = (I_{PK} - I_{OUT}) \cdot \left( \frac{L}{V_{OUT} + V_D - V_{IN}} \right) \dots\dots\dots (9)$$

When M1 is turned OFF ( $t_{OFF}$ ),  $I_L = 0$  (when the energy of the inductor is completely transmitted). Based on equation (7) :

$$\left( \frac{L}{V_{OUT} + V_D - V_{IN}} \right) = \frac{t_{OFF}}{I_{PK}} \dots\dots\dots (10)$$

When substituting equation (10) for equation (9) :

$$t_1 = t_{OFF} - \left( \frac{I_{OUT}}{I_{PK}} \right) \cdot t_{OFF} \dots\dots\dots (11)$$

Electric charge  $\Delta Q_1$  which is charged in  $C_L$  during  $t_1$  :

$$\Delta Q_1 = \int_0^{t_1} I_L dt = I_{PK} \cdot \int_0^{t_1} dt - \frac{V_{OUT} + V_D - V_{IN}}{L} \cdot \int_0^{t_1} t dt = I_{PK} \cdot t_1 - \frac{V_{OUT} + V_D - V_{IN}}{L} \cdot \frac{1}{2} t_1^2 \dots\dots\dots (12)$$

When substituting equation (12) for equation (9) :

$$\Delta Q_1 = I_{PK} - \frac{1}{2} (I_{PK} - I_{OUT}) \cdot t_1 = \frac{I_{PK} + I_{OUT}}{2} \cdot t_1 \dots\dots\dots (13)$$

A rise in voltage ( $V_{P-P}$ ) due to  $\Delta Q_1$  :

$$V_{P-P} = \frac{\Delta Q_1}{C_L} = \frac{1}{C_L} \cdot \left( \frac{I_{PK} + I_{OUT}}{2} \right) \cdot t_1 \dots\dots\dots (14)$$

When taking into consideration  $I_{OUT}$  to be consumed during  $t_1$  and the Equivalent Series Resistance ( $R_{ESR}$ ) of  $C_L$  :

$$V_{P-P} = \frac{\Delta Q_1}{C_L} = \frac{1}{C_L} \cdot \left( \frac{I_{PK} + I_{OUT}}{2} \right) \cdot t_1 + \left( \frac{I_{PK} + I_{OUT}}{2} \right) \cdot R_{ESR} - \frac{I_{OUT} \cdot t_1}{C_L} \dots\dots\dots (15)$$

When substituting equation (11) for equation (15) :

$$V_{P-P} = \frac{(I_{PK} - I_{OUT})^2}{2I_{PK}} \cdot \frac{t_{OFF}}{C_L} + \left( \frac{I_{PK} + I_{OUT}}{2} \right) \cdot R_{ESR} \dots\dots\dots (16)$$

Therefore to reduce the ripple voltage, it is important that the capacitor connected to the output pin has a large capacity and a small  $R_{ESR}$ .

■ External Parts Selection

The relationship between the major characteristics of the step-up circuit and the characteristics parameters of the external parts are shown in **Figure 15**.

| For larger output current ?                                | For higher efficiency ? |   | For smaller ripple voltage ? |
|--|-------------------------|---|------------------------------|
|  | Operation efficiency    | Stand-by efficiency                                       |                              |
| Smaller inductance   | Larger inductance       |   |                              |
| Smaller direct current resistance of inductor              |                         |   |                              |
| Larger output capacitance                                  |                         |   | Larger output capacitance    |
| With MOS FET, smaller ON resistance                        |                         | With MOS FET, smaller input capacitance                   |                              |
| With bipolar transistor, smaller external resistance $R_b$ |                         | With bipolar transistor, larger external resistance $R_b$ |                              |

**Figure 15 Relationship between Major Characteristics of Step-up Circuit and External Parts**

**1. Inductor**

The inductance value (L value) has a strong influence on the maximum output current ( $I_{OUT}$ ) and efficiency ( $\eta$ ). **Figure 16** shows the relationship between the  $I_{OUT}$  and  $\eta$  dependency on L of S-8355/56/57/58 series.



**Figure 16 L Value vs.  $I_{OUT}$  Characteristics, L Value vs.  $\eta$  Characteristics**

The peak current ( $I_{PK}$ ) increases by decreasing L value and the stability of the circuit improves and  $I_{OUT}$  increases. If L value is decreased, the efficiency falls causing a decline in the current drive capacity for the switching transistor, and  $I_{OUT}$  decreases.

The loss of  $I_{PK}$  by the switching transistor decreases by increasing L value and the efficiency becomes maximum at a certain L value. Further increasing L value decreases the efficiency due to the loss of the direct current resistance of the coil.  $I_{OUT}$  also decreases.

A higher oscillation frequency allows selection of a lower L value, making the coil smaller.

The recommended inductances are a 22 to 100  $\mu\text{H}$  for B, E, and K types, a 4.7 to 47  $\mu\text{H}$  for F, G, H, J, L, and M types, 3.0 to 22  $\mu\text{H}$  for N, P and Q types.

Be careful of the allowable inductor current when choosing an inductor. Exceeding the allowable current of the inductor causes magnetic saturation, much lower efficiency and destruction of the IC chip due to a large current.

Choose an inductor so that  $I_{PK}$  does not exceed the allowable current.  $I_{PK}$  in discontinuous mode is calculated by the following equation:

$$I_{PK} = \sqrt{\frac{2 I_{OUT} (V_{OUT} + V_D - V_{IN})}{f_{OSC} \cdot L}} \text{ (A)} \dots\dots\dots (17)$$

$f_{osc}$  = oscillation frequency,  $V_D \cong 0.4\text{ V}$ .

**2. Diode**

Use an external diode that meets the following requirements :

- Low forward voltage :  $V_F < 0.3\text{ V}$
- High switching speed : 500 ns max.
- Reverse voltage :  $V_{OUT} + V_F$  or more
- Current rate :  $I_{PK}$  or more

### 3. Capacitor ( $C_{IN}$ , $C_L$ )

A capacitor on the input side ( $C_{IN}$ ) improves the efficiency by reducing the power impedance and stabilizing the input current. Select a  $C_{IN}$  value according to the impedance of the power supply used.

A capacitor on the output side ( $C_L$ ) is used for smoothing the output voltage. For step-up types, the output voltage flows intermittently to the load current, so step-up types need a larger capacitance than step-down types. Therefore, select an appropriate capacitor in accordance with the ripple voltage, which increases in case of a higher output voltage or a higher load current. The capacitor value should be 10  $\mu$ F or more.

Select an appropriate capacitor the equivalent series resistance ( $R_{ESR}$ ) for stable output voltage. The stable voltage range in this IC depends on the  $R_{ESR}$ . Although the inductance value (L value) is also a factor, an  $R_{ESR}$  of 30 to 500 m $\Omega$  maximizes the characteristics. However, the best  $R_{ESR}$  value may depend on the L value, the capacitance, the wiring, and the applications (output load). Therefore, fully evaluate the  $R_{ESR}$  under the actual operating conditions to determine the best value.

Refer to the “3. Example of Ceramic Capacitor Application” (Figure 26) in the “Application Circuit” for the circuit example using a ceramic capacitor and the external resistance of the capacitor ( $R_{ESR}$ ).

### 4. External Transistor

An enhancement (N-channel) MOS FET type or A bipolar (NPN) type can be used as the external transistor.

#### 4.1 Enhancement (N-channel) MOS FET Type

Figure 17 is a circuit example using a MOS FET transistor (N-channel).



\*1. For  $V_{DD}$  /  $V_{OUT}$  separate type.

\*2. With shutdown function.

**Figure 17 Circuit Example Using MOS FET (N-channel) Type**

An N-channel power MOS FET should be used for the MOS FET. Because the gate voltage and current of the external power MOS FET are supplied from the stepped-up output voltage ( $V_{OUT}$ ), the MOS FET is driven more effectively.

A large current may flow during startup, depending on the MOS FET selection. So perform sufficient evaluation using the actual devices. Also recommend to use a MOS FET with an input capacitance of 700 pF or less.

Since the ON-resistance of the MOS FET might depend on the difference between the output voltage ( $V_{OUT}$ ) and the threshold voltage of the MOS FET, and affect the output current as well as the efficiency, the threshold voltage should be low. When the output voltage is low, the circuit operates only when the MOS FET has a threshold voltage lower than the output voltage.

**4.2 Bipolar (NPN) Type**

A circuit example using the CPH3210 ( $h_{FE} = 200$  to  $560$ ) from Sanyo Electric Co., Ltd. As a bipolar transistor (NPN) is shown in **Figure 19 to 24** in the “**■ Standard Circuits**”. The  $h_{FE}$  value and  $R_b$  value of the bipolar transistor determine the driving capacity to increase the output current using a bipolar transistor. A peripheral circuit example of the transistor is shown in **Figure 18**.

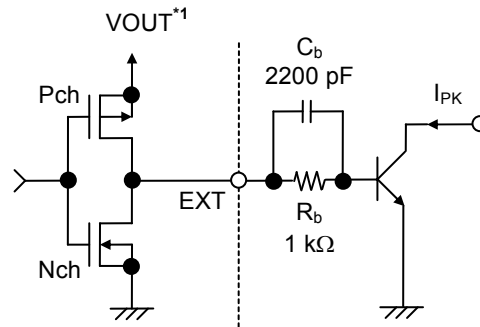

\*1.  $V_{DD}$  for E, G, J, K, L, M, P and Q types.

**Figure 18 External Transistor Peripheral Circuit**

The recommended  $R_b$  value is around  $1\text{ k}\Omega$ . Actually, calculate the necessary base current ( $I_b$ ) from the bipolar transistor ( $h_{FE}$ ) using  $I_b = \frac{I_{PK}}{h_{FE}}$ , and select the smaller  $R_b$  value than  $R_b = \frac{V_{OUT} - 0.7}{I_b} - \frac{0.4}{|I_{EXTH}|}$  \*1.

A small  $R_b$  value can increase the output current, but the efficiency decreases. Since a current may flow on the pulse and the voltage may drop due to wiring resistance or other factors in the actual circuit, therefore the optimum  $R_b$  value should be determined by experiment.

Connecting the speed-up capacitor ( $C_b$ ) in parallel with the  $R_b$  resistance as shown in **Figure 18**, decreases switching loss and improves the efficiency.

The  $C_b$  value is calculated according to  $C_b \leq \frac{1}{2\pi \cdot R_b \cdot f_{osc} \cdot 0.7}$ .

Select a  $C_b$  value after performing sufficient evaluation since the optimum  $C_b$  value differs depending upon the characteristics of the bipolar transistor.

\*1. For E, G, J, K, L, M, P and Q type,  $R_b = \frac{V_{DD} - 0.7}{I_b} - \frac{0.4}{|I_{EXTH}|}$ .

**5. V<sub>DD</sub> / V<sub>OUT</sub> Separate Type (For E, G, J, K, L, M, P and Q Types)**

The E, G, J, K, L, M, P and Q types provides separate internal circuit power supply (V<sub>DD</sub> pin) and output voltage setting pin (V<sub>OUT</sub> pin) in the IC, making it ideal for the following applications.

- (1) When changing the output voltage with external resistance.
- (2) When outputting a high voltage such as +15 V or +20 V.

Choose the products in the **Table 24** according to the applications (1) or (2) above.

**Table 24**

| Output Voltage (V <sub>CC</sub> ) | 1.8 V ≤ V <sub>CC</sub> < 5 V      | 5 V ≤ V <sub>CC</sub> | Reference Circuit                          |
|-----------------------------------|------------------------------------|-----------------------|--|
| S-835xx18                         | Yes                                | Yes                   | Application circuit 1 ( <b>Figure 25</b> ) |
| S-835xx50                         | –                                  | Yes                   | Application circuit 1 ( <b>Figure 25</b> ) |
| Connection to VDD pin             | V <sub>IN</sub> or V <sub>CC</sub> | V <sub>IN</sub>       | –  |

**Cautions** 1. This IC starts a step-up operation at V<sub>DD</sub> = 0.8 V, but set 1.8 ≤ V<sub>DD</sub> ≤ 10 V to stabilize the output voltage and frequency of the oscillator. (Input a voltage of 1.8 V or more at the VDD pin for all products with a setting less than 1.9 V.) An input voltage of 1.8 V or more at the VDD pin allows connection of the VDD pin to either the input voltage V<sub>IN</sub> pin or output V<sub>OUT</sub> pin.

2. Choose external resistors R<sub>A</sub> and R<sub>B</sub> so as to not affect the output voltage, considering that there is impedance between the V<sub>OUT</sub> pin and VSS pin in the IC chip. The internal resistance between the V<sub>OUT</sub> pin and VSS pin is as follows :

- (1) S-835xx18 : 2.1 to 14.8 MΩ
- (2) S-835xx20 : 1.4 to 14.8 MΩ
- (3) S-835xx30 : 1.4 to 14.2 MΩ
- (4) S-835xx50 : 1.4 to 12.1 MΩ

3. Attach a capacitor (C<sub>C</sub>) in parallel to the R<sub>A</sub> resistance when an unstable event such as oscillation of the output voltage occurs. Calculate C<sub>C</sub> using the following equation :

$$C_c [F] = \frac{1}{2 \cdot \pi \cdot R_A \cdot 20 \text{ kHz}}$$

■ **Standard Circuits**

- (1) **S-8357BxxMA, S-8357BxxUA, S-8358BxxMA, S-8358BxxUA**

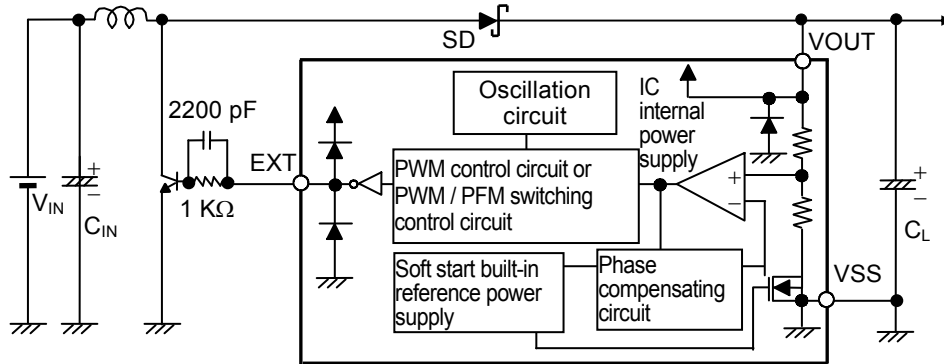

**Remark** The power supply for the IC chip is from the VOUT pin.

**Figure 19**

- (2) **S-8357BxxMC, S-8357FxxMC, S-8357HxxMC, S-8357NxxMC, S-8358BxxMC, S-8358FxxMC, S-8358HxxMC, S-8358NxxMC**



**Remark** The power supply for the IC chip is from the VOUT pin.

**Figure 20**

- (3) **S-8357ExxMC, S-8357GxxMC, S-8357JxxMC, S-8357PxxMC, S-8358ExxMC, S-8358GxxMC, S-8358JxxMC, S-8358PxxMC**



**Remark** The power supply for the IC chip is from the VDD pin.

**Figure 21**



- (4) S-8357ExxMC, S-8357GxxMC, S-8357JxxMC, S-8358ExxMC, S-8358GxxMC, S-8358JxxMC



**Remark** The power supply for the IC chip is from the VDD pin.

**Figure 22**

- (5) S-8355KxxMC, S-8355LxxMC, S-8355MxxMC, S-8355QxxMC, S-8356KxxMC, S-8356LxxMC, S-8356MxxMC, S-8356QxxMC



**Remark** The power supply for the IC chip is from the VDD pin.

**Figure 23**

- (6) S-8355KxxMC, S-8355LxxMC, S-8355MxxMC, S-8356KxxMC, S-8356LxxMC, S-8356MxxMC



**Remark** The power supply for the IC chip is from the VDD pin.

**Figure 24**

**Caution** The above connection diagram and constant will not guarantee successful operation. Perform through evaluation using the actual application to set the constant.

## ■ Precautions

- Mount external capacitors, the diode, and the coil as close as possible to the IC.
- Characteristics ripple voltage and spike noise occur in IC containing switching regulators. Moreover rush current flows at the time of a power supply injection. Because these largely depend on the coil, the capacitor and impedance of power supply used, fully check them using an actually mounted model.
- Make sure that the dissipation of the switching transistor (especially at a high temperature) does not exceed the allowable power dissipation of the package.
- The performance of this IC varies depending on the design of the PCB patterns, peripheral circuits and external parts. Thoroughly test all settings with your device. Also, try to use the recommended external parts. If not, contact an ABLIC Inc. sales person.
- Do not apply an electrostatic discharge to this IC that exceeds the performance ratings of the built-in electrostatic protection circuit.
- ABLIC Inc. claims no responsibility for any disputes arising out of or in connection with any infringement by products including this IC of patents owned by a third party.

## ■ Application Circuits

### 1. LCD Power Supply

The following example is an application power supply circuit (15 V / 20 V output) to drive an LCD panel, and its characteristics.



Figure 25 Power Supply Circuit Example for LCD

Table 25

| Condition | Output Voltage | IC        | L Type Name  | TR Type Name | SD Type Name | C <sub>L</sub>       | R <sub>a</sub> | R <sub>b</sub> | C <sub>c</sub> |
|-----------|----------------|-----------|--------------|--------------|--------------|----------------------|----------------|----------------|----------------|
| 1         | 15 V           | S-8356M50 | CDRH5D18-220 | MCH3405      | MA2Z748      | F93<br>(20 V, 10 μF) | 580 kΩ         | 300 kΩ         | 15 pF          |
| 2         | 20 V           | S-8356M50 | CDRH5D18-220 | FDN337N      | MA729        | F93<br>(25 V, 10 μF) | 575 kΩ         | 200 kΩ         | 15 pF          |
| 3         | 10 V           | S-8356Q50 | CDRH5D18-100 | MCH3405      | MA2Z748      | F93<br>(20 V, 10 μF) | 560 kΩ         | 560 kΩ         | 15 pF          |

**Caution** The above connection diagram and constant will not guarantee successful operation. Perform through evaluation using the actual application to set the constant.

**2. Output Characteristics of The Power Supply for LCD**

The data of the step-up characteristics (a) Output current ( $I_{OUT}$ ) vs. Efficiency ( $\eta$ ) characteristics, (b) Output current ( $I_{OUT}$ ) vs. Output voltage ( $V_{OUT}$ ) characteristics under conditions of 1 to 3 in **Table 25** is shown below.

**Condition 1**



**Condition 2**



**Condition 3**



### 3. Using Ceramic Capacitor Example

When using small  $R_{ESR}$  parts such as ceramic capacitors for the output capacitance, mount a resistor ( $R_1$ ) corresponding to the  $R_{ESR}$  in series with the ceramic capacitor ( $C_L$ ) as shown in **Figure 26**.  $R_1$  differs depending on “L” value, the capacitance, the wiring, and the application (output load). The following example shows a circuit using  $R_1 = 100\text{ m}\Omega$ , output voltage = 3.3 V, output load = 500 mA and its characteristics.



Figure 26 Using Ceramic Capacitor Circuit Example

Table 26

| Condition | IC        | L Type Name  | TR Type Name | SD Type Name | SD Type Name              | $R_1$          |
|-----------|-----------|--------------|--------------|--------------|---------------------------|----------------|
| 1         | S-8357F33 | CDRH6D28-220 | FDN335N      | M1FH3        | 10 $\mu\text{F} \times 2$ | 100 m $\Omega$ |
| 2         | S-8358B50 | CDRH6D28-470 | FDN335N      | M1FH3        | 10 $\mu\text{F} \times 2$ | 100 m $\Omega$ |
| 3         | S-8357N33 | CDRH6D28-100 | FDN335N      | M1FH3        | 10 $\mu\text{F} \times 2$ | 100 m $\Omega$ |

**Caution** The above connection diagram and constant will not guarantee successful operation. Perform through evaluation using the actual application to set the constant.

**4. Output Characteristics of The Using Ceramic Capacitor Circuit Example**

The data of the step-up characteristics (a) Output current ( $I_{OUT}$ ) vs. Efficiency ( $\eta$ ) characteristics, (b) Output current ( $I_{OUT}$ ) vs. Output voltage ( $V_{OUT}$ ) characteristics, (c) Output Current ( $I_{OUT}$ ) vs. Ripple voltage ( $V_r$ ) under conditions of 1 to 3 in **Table 26** is shown below.

**Condition 1**



**Condition 2**



**Condition 3**

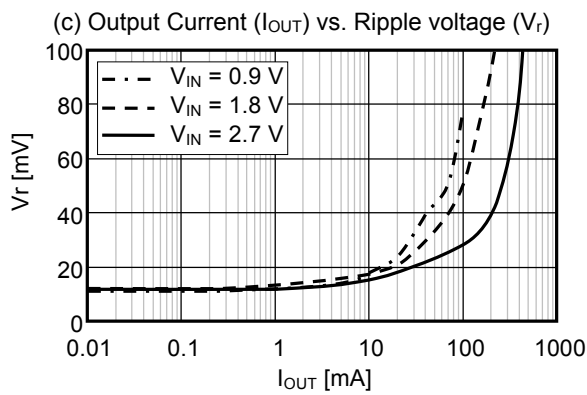
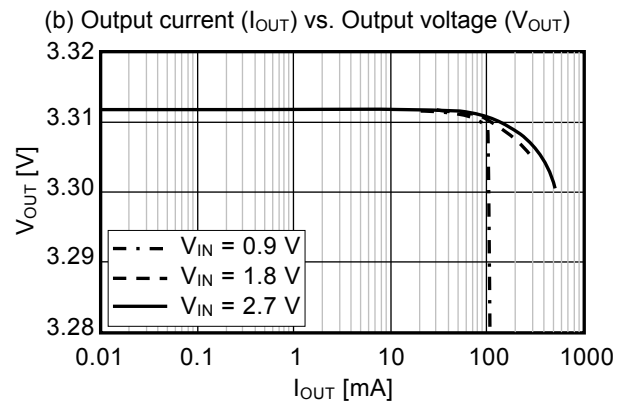
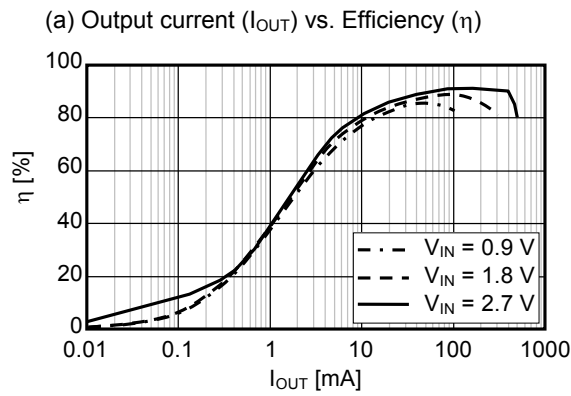

■ **Characteristics (Typical Data)**

1. Example of Major Temperature characteristics (Ta = -40 to +85 °C)

(1) Current Consumption 1 (I<sub>SS1</sub>) vs. Temperature (Ta) (V<sub>OUT</sub> = 3.3 V)



(2) Current Consumption 2 (I<sub>SS2</sub>) vs. Temperature (Ta) (V<sub>OUT</sub> = 3.3 V)





**(3) Current Consumption at Shutdown ( $I_{SS}$ ) vs. Temperature ( $T_a$ )**



**(4) EXT Pin Output Current "H" ( $I_{EXTH}$ ) vs. Temperature ( $T_a$ )**



**(5) EXT Pin Output Current "L" ( $I_{EXTL}$ ) vs. Temperature ( $T_a$ )**



**(6) Oscillation Frequency ( $f_{OSC}$ ) vs. Temperature ( $T_a$ ) ( $V_{OUT} = 3.3 \text{ V}$ )**



(7) Maximum Duty Ratio (MaxDuty) vs. Temperature (Ta) (V<sub>OUT</sub> = 3.3 V)



(8) PWM / PFM Switching Duty Ratio (PFMDuty) vs. Temperature (Ta) (S-8356/58 Series)



(9) ON/OFF Pin Input Voltage "H" (V<sub>SH</sub>) vs. Temperature (Ta)



(10) ON/OFF Pin Input Voltage "L" 1 (V<sub>SL1</sub>) vs. Temperature (Ta)



(11) ON/OFF Pin Input Voltage "L" 2 (V<sub>SL2</sub>) vs. Temperature (Ta)



(12) Soft Start Time ( $t_{SS}$ ) vs. Temperature ( $T_a$ ) ( $V_{OUT} = 3.3\text{ V}$ )

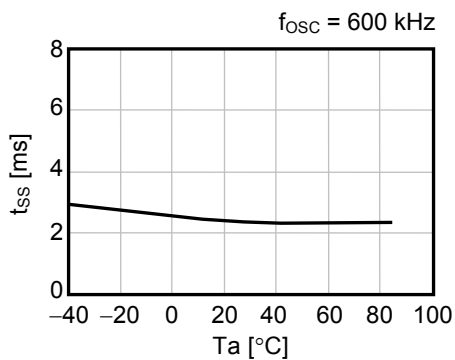
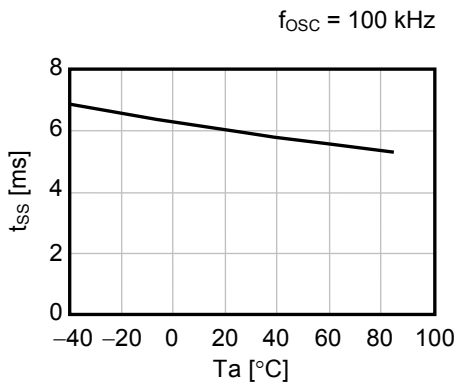

(13) Operation Start Voltage ( $V_{ST1}$ ) vs. Temperature ( $T_a$ )

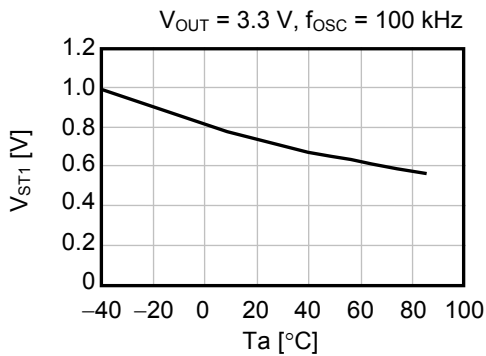

(14) Oscillation Start Voltage ( $V_{ST2}$ ) vs. Temperature ( $T_a$ )



(15) Output Voltage ( $V_{OUT}$ ) vs. Temperature ( $T_a$ ) ( $V_{OUT} = 3.3\text{ V}$ )



**2. Examples of Major Power Supply Dependence Characteristics (Ta = 25 °C)**

(1) Current Consumption 1 ( $I_{SS1}$ ) vs. Power Supply Voltage ( $V_{DD}$ ), Current Consumption 2 ( $I_{SS2}$ ) vs. Power Supply Voltage ( $V_{DD}$ ) ( $V_{OUT} = 3.3 V$ )



(2) Current Consumption at Shutdown ( $I_{SSS}$ ) vs. Power Supply Voltage ( $V_{DD}$ )



(3) Oscillation Frequency ( $f_{OSC}$ ) vs. Power Supply Voltage ( $V_{DD}$ )



**(4) Maximum Duty Ratio (MaxDuty) vs. Power Supply Voltage ( $V_{DD}$ )**



**(5) EXT Pin Output Current "H" ( $I_{EXTH}$ ) vs. Power Supply Voltage ( $V_{DD}$ )**



**(6) EXT Pin Output Current "L" ( $I_{EXTL}$ ) vs. Power Supply Voltage ( $V_{DD}$ )**



(7) Output Voltage ( $V_{OUT}$ ) vs. Power Supply Voltage ( $V_{DD}$ ) ( $V_{DD}$  Separate Type,  $V_{OUT} = 3.3\text{ V}$ ,  $V_{IN} = 1.98\text{ V}$ ,  $I_{OUT} = 66\text{ mA}$ )



**3. Output Waveforms**

**(1) S-8358B33MC**



**(2) S-8358F33MC**





(3) S-8358N33MC



**4. Examples of Transient Response Characteristics**

**(1) Power-On ( $V_{IN} : 0\text{ V} \rightarrow 2\text{ V}$ )**

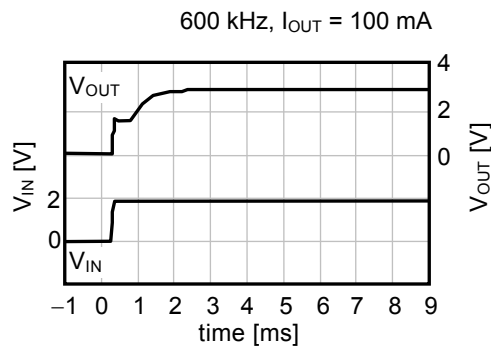

(2) ON/OFF Pin Response ( $V_{ON/OFF} : 0\text{ V} \rightarrow 2.0\text{ V}$ )

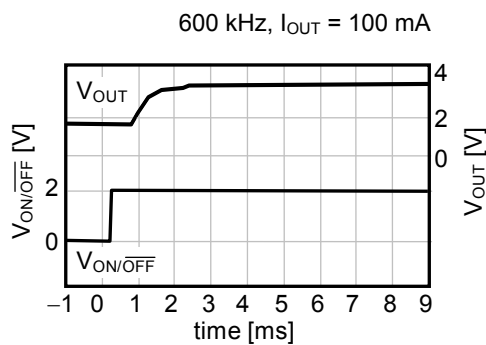
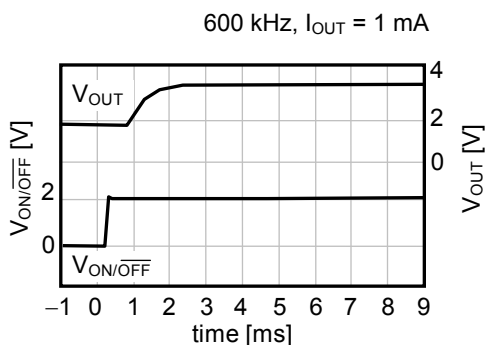
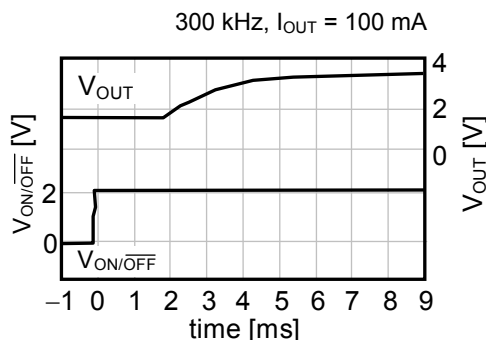
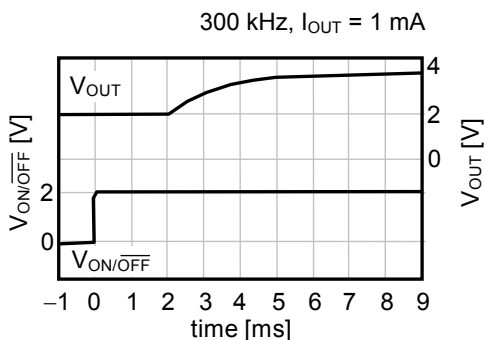
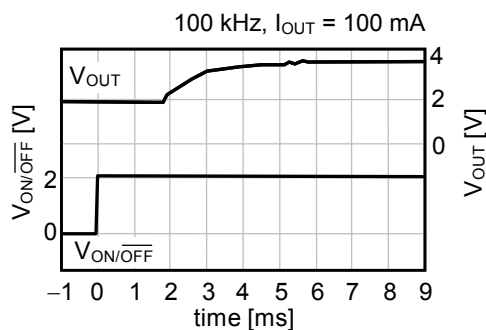
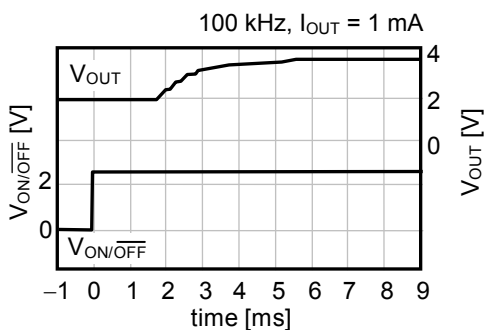

**(3) Load Fluctuations**



**(4) Input Voltage Fluctuations ( $I_{OUT} = 100 \text{ mA}$ )**

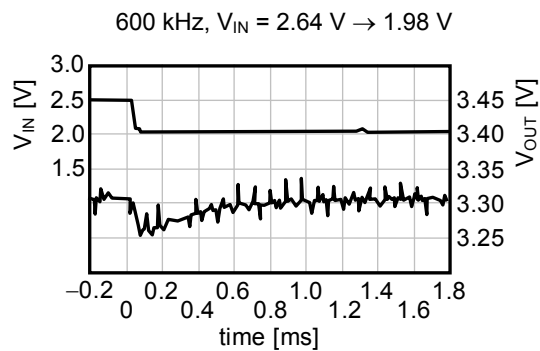
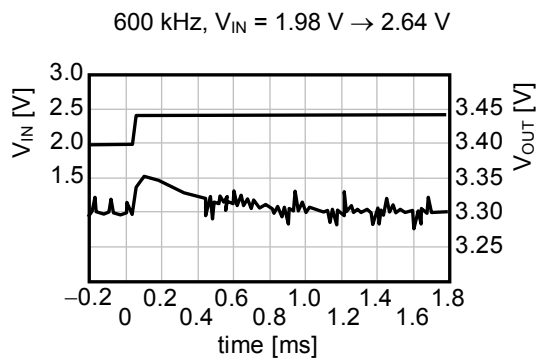
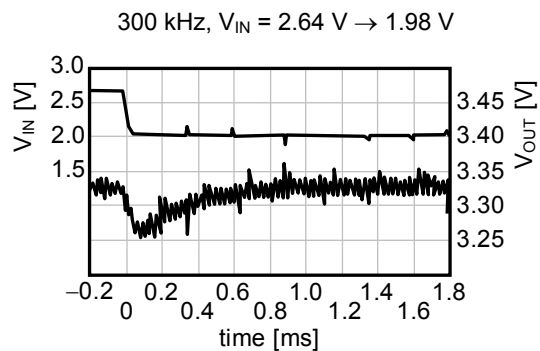
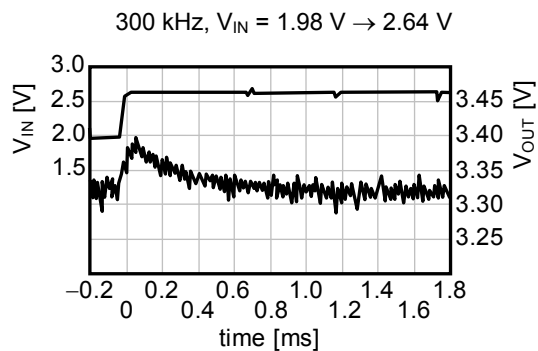
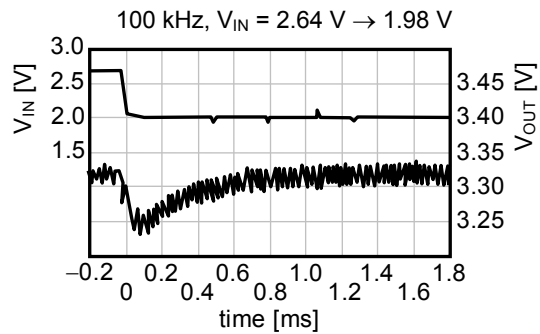
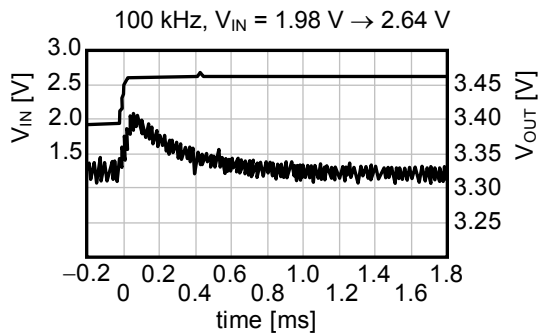

■ Reference Data

Use this reference data to choose the external parts. This reference data makes it possible to choose the recommended external part based on the application and characteristics data.

1. External Parts for Reference Data

Table 27 Efficiency vs. Output Current Characteristics and Output Voltage vs. Output Current Characteristics for External

| Condition | Product Name | Oscillation Frequency | Output Voltage | Control System | Inductor     | Transistor | Diode   | Output capacitor      |
|-----------|--------------|-----------------------|----------------|----------------|--------------|------------|---------|-----------------------|
| 1         | S-8357F33    | 300 kHz               | 3.3 V          | PWM            | CDRH104R-220 | FDN335N    | M1FH3   | F93 (16 V, 47 μF) × 2 |
| 2         | S-8357F50    | 300 kHz               | 5.0 V          | PWM            |              |            |         |                       |
| 3         | S-8356M50    | 300 kHz               | 5.0 V          | PWM/PFM        |              |            |         |                       |
| 4         | S-8357B33    | 100 kHz               | 3.3 V          | PWM            | CDRH104R-470 |            |         |                       |
| 5         | S-8358B33    | 100 kHz               | 3.3 V          | PWM/PFM        |              |            |         |                       |
| 6         | S-8357B50    | 100 kHz               | 5.0 V          | PWM            |              |            |         |                       |
| 7         | S-8356M50    | 300 kHz               | 5.0 V          | PWM/PFM        | CDRH8D28-220 |            |         | F93 (16 V, 47 μF)     |
| 8         | S-8357B33    | 100 kHz               | 3.3 V          | PWM            | CDRH8D28-470 |            |         |                       |
| 9         | S-8358B33    | 100 kHz               | 3.3 V          | PWM/PFM        |              |            |         |                       |
| 10        | S-8357B50    | 100 kHz               | 5.0 V          | PWM            |              |            |         |                       |
| 11        | S-8357F33    | 300 kHz               | 3.3 V          | PWM            | CXLP120-220  | MCH3405    | MA2Z748 | F92 (6.3 V, 47 μF)    |
| 12        | S-8356M50    | 300 kHz               | 5.0 V          | PWM/PFM        |              |            |         |                       |
| 13        | S-8357N33    | 600 kHz               | 3.3 V          | PWM            | CDRH8D28-100 | FDN335N    | M1FH3   | F93 (16 V, 47 μF)     |
| 14        | S-8357N50    | 600 kHz               | 5.0 V          | PWM            |              |            |         |                       |
| 15        | S-8356Q33    | 600 kHz               | 3.3 V          | PWM/PFM        |              |            |         |                       |
| 16        | S-8356Q50    | 600 kHz               | 5.0 V          | PWM/PFM        |              |            |         |                       |

The properties of the external parts are shown below.

**Table 28 Properties of External Parts**

| Component                         | Product Name | Manufacturer                                | Characteristics   |
|-----------------------------------|--------------|---|---|
| Inductor                          | CDRH104R-220 | Sumida Corporation                          | 22 $\mu$ H, DCR <sup>*1</sup> = 73 m $\Omega$ , I <sub>MAX</sub> <sup>*2</sup> = 2.5 A, Component height = 4.0 mm   |
|                                   | CDRH104R-470 |   | 47 $\mu$ H, DCR <sup>*1</sup> = 128 m $\Omega$ , I <sub>MAX</sub> <sup>*2</sup> = 1.9 A, Component height = 4.0 mm  |
|                                   | CDRH8D28-100 |   | 10 $\mu$ H, DCR <sup>*1</sup> = 47 m $\Omega$ , I <sub>MAX</sub> <sup>*2</sup> = 2.7 A, Component height = 3.0 mm   |
|                                   | CDRH8D28-220 |   | 22 $\mu$ H, DCR <sup>*1</sup> = 99 m $\Omega$ , I <sub>MAX</sub> <sup>*2</sup> = 1.8 A, Component height = 3.0 mm   |
|                                   | CDRH8D28-470 |   | 47 $\mu$ H, DCR <sup>*1</sup> = 195 m $\Omega$ , I <sub>MAX</sub> <sup>*2</sup> = 1.25 A, Component height = 3.0 mm   |
|                                   | CXLP120-220  | Sumitomo Special Metals Co., Ltd.           | 22 $\mu$ H, DCR <sup>*1</sup> = 590 m $\Omega$ , I <sub>MAX</sub> <sup>*2</sup> = 0.55 A, Component height = 1.2 mm   |
| Diode                             | M1FH3        | Shindengen Electric Manufacturing Co., Ltd. | V <sub>F</sub> <sup>*3</sup> = 0.3 V, I <sub>F</sub> <sup>*4</sup> = 1.5 A  |
|                                   | MA2Z748      | Matsushita Electric Industrial Co., Ltd.    | V <sub>F</sub> <sup>*3</sup> = 0.4 V, I <sub>F</sub> <sup>*4</sup> = 0.3 A  |
| Capacitor<br>(Output Capacitance) | F93          | Nichicon Corporation                        | 16 V, 47 $\mu$ F  |
|                                   | F92          |   | 6.3 V, 47 $\mu$ F   |
| Transistor<br>(Nch FET)           | FDN335N      | Fairchild Semiconductor Japan Ltd.          | V <sub>DSS</sub> <sup>*5</sup> = 20 V max., V <sub>GSS</sub> <sup>*6</sup> = 8 V max., C <sub>ISS</sub> <sup>*7</sup> = 310 pF, I <sub>D</sub> <sup>*8</sup> = 1.5 A (V <sub>GS</sub> <sup>*6</sup> = 2.5 V)  |
|                                   | MCH3405      | Sanyo Electric Co., Ltd.                    | V <sub>DSS</sub> <sup>*5</sup> = 20 V max., V <sub>GSS</sub> <sup>*6</sup> = 10 V max., C <sub>ISS</sub> <sup>*7</sup> = 280 pF, I <sub>D</sub> <sup>*8</sup> = 0.5 A (V <sub>GS</sub> <sup>*6</sup> = 1.8 V) |

- \*1. Direct current resistance
- \*2. Maximum allowable current
- \*3. Forward voltage
- \*4. Forward current
- \*5. Drain source voltage
- \*6. Gate source voltage
- \*7. Input capacitance
- \*8. Drain current

**Caution** The values shown in the characteristics column of Table 28 above are based on the materials provided by each manufacture. However, consider the characteristics of the original materials when using the above products.

**2. Output Current ( $I_{OUT}$ ) vs. Efficiency ( $\eta$ ) Characteristics, Output Current ( $I_{OUT}$ ) vs. Output Voltage ( $V_{OUT}$ ) Characteristics**

The following shows the actual (a) Output current ( $I_{OUT}$ ) vs. Efficiency ( $\eta$ ) characteristics and (b) Output current ( $I_{OUT}$ ) vs. Output voltage ( $V_{OUT}$ ) characteristics under the conditions of No. 1 to 16 in **Table 27**.

**Condition 1 S-8357F33**

(a) Output current ( $I_{OUT}$ ) vs. Efficiency ( $\eta$ )



(b) Output current ( $I_{OUT}$ ) vs. Output voltage ( $V_{OUT}$ )



**Condition 2 S-8357F50**

(a) Output current ( $I_{OUT}$ ) vs. Efficiency ( $\eta$ )



(b) Output current ( $I_{OUT}$ ) vs. Output voltage ( $V_{OUT}$ )



**Condition 3 S-8356M50**

(a) Output current ( $I_{OUT}$ ) vs. Efficiency ( $\eta$ )



(b) Output current ( $I_{OUT}$ ) vs. Output voltage ( $V_{OUT}$ )

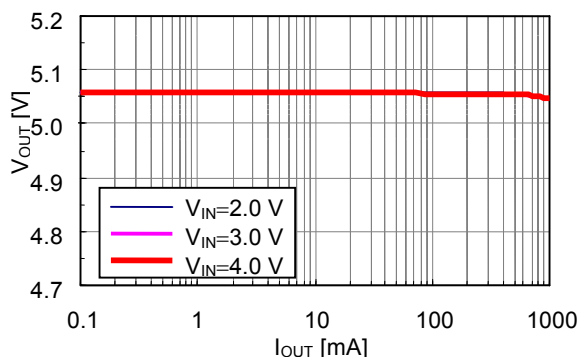



**Condition 4 S-8357B33**

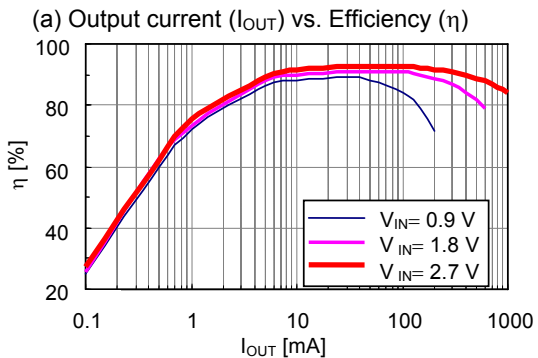

**Condition 5 S-8358B33**

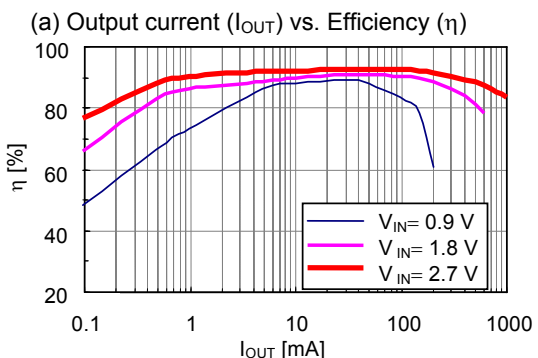

**Condition 6 S-8357B50**



**Condition 7 S-8357M50**

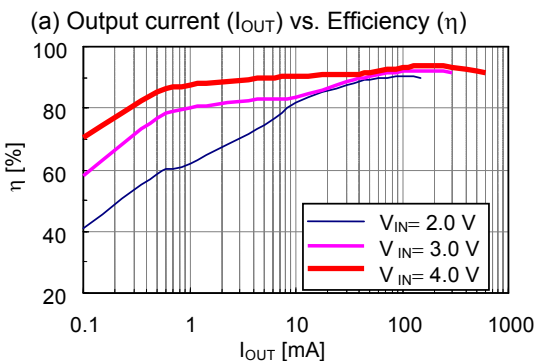

**Condition 8 S-8357B33**



**Condition 9 S-8358B33**



**Condition 10 S-8357B50**



**Condition 11 S-8357F33**



**Condition 12 S-8356M50**



**Condition 13 S-8357N33**



**Condition 14 S-8357N50**



**Condition 15 S-8356Q33**



**Condition 16 S-8356Q50**



### 3. Output Current ( $I_{OUT}$ ) vs. Ripple Voltage ( $V_r$ ) Characteristics

The following shows the actual Output current ( $I_{OUT}$ ) vs. Ripple voltage ( $V_r$ ) characteristics and (b) Output current ( $I_{OUT}$ ) vs. Output voltage ( $V_{OUT}$ ) characteristics under the conditions of No. 1 to 16 in Table 27.

**Condition 1 S-8357F33**



**Condition 2 S-8357F50**



**Condition 3 S-8356M50**



**Condition 4 S-8357B33**



**Condition 5 S-8358B33**



**Condition 6 S-8357B50**



**Condition 7 S-8356M50**



**Condition 8 S-8357B33**



**Condition 9 S-8358B33**



**Condition 10 S-8357B50**



**Condition 11 S-8357F33**



**Condition 12 S-8356M50**



**Condition 13 S-8357N33**



**Condition 14 S-8357N50**



**Condition 15 S-8356Q33**



**Condition 16 S-8356Q50**





No. MP003-A-P-SD-1.2

|                   |                         |
|-------------------|-------------------------|
| TITLE             | SOT233-A-PKG Dimensions |
| No.               | MP003-A-P-SD-1.2        |
| ANGLE             |                         |
| UNIT              | mm                      |
|                   |                         |
| <b>ABLIC Inc.</b> |                         |



→  
Feed direction

No. MP003-A-C-SD-2.0

|                   |                       |
|-------------------|-----------------------|
| TITLE             | SOT233-A-Carrier Tape |
| No.               | MP003-A-C-SD-2.0      |
| ANGLE             |                       |
| UNIT              | mm                    |
|                   |                       |
| <b>ABLIC Inc.</b> |                       |





Enlarged drawing in the central part



No. MP003-A-R-SD-1.1

|       |                  |      |       |
|-------|------------------|------|-------|
| TITLE | SOT233-A-Reel    |      |       |
| No.   | MP003-A-R-SD-1.1 |      |       |
| ANGLE |                  | QTY. | 3,000 |
| UNIT  | mm               |      |       |
|       |                  |      |       |

**ABLIC Inc.**



No. MP005-A-P-SD-1.3

|                   |                         |
|-------------------|-------------------------|
| TITLE             | SOT235-A-PKG Dimensions |
| No.               | MP005-A-P-SD-1.3        |
| ANGLE             |                         |
| UNIT              | mm                      |
| <b>ABLIC Inc.</b> |                         |



Feed direction →

No. MP005-A-C-SD-2.1

|                   |                       |
|-------------------|-----------------------|
| TITLE             | SOT235-A-Carrier Tape |
| No.               | MP005-A-C-SD-2.1      |
| ANGLE             |                       |
| UNIT              | mm                    |
|                   |                       |
| <b>ABLIC Inc.</b> |                       |



Enlarged drawing in the central part



No. MP005-A-R-SD-1.1

|                   |                  |      |       |
|-------------------|------------------|------|-------|
| TITLE             | SOT235-A-Reel    |      |       |
| No.               | MP005-A-R-SD-1.1 |      |       |
| ANGLE             |                  | QTY. | 3,000 |
| UNIT              | mm               |      |       |
|                   |                  |      |       |
| <b>ABLIC Inc.</b> |                  |      |       |



No. UP003-A-P-SD-2.0

|       |                         |
|-------|-------------------------|
| TITLE | SOT893-A-PKG Dimensions |
| No.   | UP003-A-P-SD-2.0        |
| ANGLE |                         |
| UNIT  | mm                      |
|       |                         |

**ABLIC Inc.**



→  
Feed direction

No. UP003-A-C-SD-2.0

|                   |                       |
|-------------------|-----------------------|
| TITLE             | SOT893-A-Carrier Tape |
| No.               | UP003-A-C-SD-2.0      |
| ANGLE             |                       |
| UNIT              | mm                    |
|                   |                       |
| <b>ABLIC Inc.</b> |                       |



Enlarged drawing in the central part



No. UP003-A-R-SD-1.1

|       |                  |      |       |
|-------|------------------|------|-------|
| TITLE | SOT893-A-Reel    |      |       |
| No.   | UP003-A-R-SD-1.1 |      |       |
| ANGLE |                  | QTY. | 1,000 |
| UNIT  | mm               |      |       |
|       |                  |      |       |

**ABLIC Inc.**

## Disclaimers (Handling Precautions)

1. All the information described herein (product data, specifications, figures, tables, programs, algorithms and application circuit examples, etc.) is current as of publishing date of this document and is subject to change without notice.
2. The circuit examples and the usages described herein are for reference only, and do not guarantee the success of any specific mass-production design.  
ABLIC Inc. is not liable for any losses, damages, claims or demands caused by the reasons other than the products described herein (hereinafter "the products") or infringement of third-party intellectual property right and any other right due to the use of the information described herein.
3. ABLIC Inc. is not liable for any losses, damages, claims or demands caused by the incorrect information described herein.
4. Be careful to use the products within their ranges described herein. Pay special attention for use to the absolute maximum ratings, operation voltage range and electrical characteristics, etc.  
ABLIC Inc. is not liable for any losses, damages, claims or demands caused by failures and / or accidents, etc. due to the use of the products outside their specified ranges.
5. Before using the products, confirm their applications, and the laws and regulations of the region or country where they are used and verify suitability, safety and other factors for the intended use.
6. When exporting the products, comply with the Foreign Exchange and Foreign Trade Act and all other export-related laws, and follow the required procedures.
7. The products are strictly prohibited from using, providing or exporting for the purposes of the development of weapons of mass destruction or military use. ABLIC Inc. is not liable for any losses, damages, claims or demands caused by any provision or export to the person or entity who intends to develop, manufacture, use or store nuclear, biological or chemical weapons or missiles, or use any other military purposes.
8. The products are not designed to be used as part of any device or equipment that may affect the human body, human life, or assets (such as medical equipment, disaster prevention systems, security systems, combustion control systems, infrastructure control systems, vehicle equipment, traffic systems, in-vehicle equipment, aviation equipment, aerospace equipment, and nuclear-related equipment), excluding when specified for in-vehicle use or other uses by ABLIC, Inc. Do not apply the products to the above listed devices and equipments.  
ABLIC Inc. is not liable for any losses, damages, claims or demands caused by unauthorized or unspecified use of the products.
9. In general, semiconductor products may fail or malfunction with some probability. The user of the products should therefore take responsibility to give thorough consideration to safety design including redundancy, fire spread prevention measures, and malfunction prevention to prevent accidents causing injury or death, fires and social damage, etc. that may ensue from the products' failure or malfunction.  
The entire system in which the products are used must be sufficiently evaluated and judged whether the products are allowed to apply for the system on customer's own responsibility.
10. The products are not designed to be radiation-proof. The necessary radiation measures should be taken in the product design by the customer depending on the intended use.
11. The products do not affect human health under normal use. However, they contain chemical substances and heavy metals and should therefore not be put in the mouth. The fracture surfaces of wafers and chips may be sharp. Be careful when handling these with the bare hands to prevent injuries, etc.
12. When disposing of the products, comply with the laws and ordinances of the country or region where they are used.
13. The information described herein contains copyright information and know-how of ABLIC Inc. The information described herein does not convey any license under any intellectual property rights or any other rights belonging to ABLIC Inc. or a third party. Reproduction or copying of the information from this document or any part of this document described herein for the purpose of disclosing it to a third-party is strictly prohibited without the express permission of ABLIC Inc.
14. For more details on the information described herein or any other questions, please contact ABLIC Inc.'s sales representative.
15. This Disclaimers have been delivered in a text using the Japanese language, which text, despite any translations into the English language and the Chinese language, shall be controlling.

2.4-2019.07



# Mouser Electronics

Authorized Distributor

Click to View Pricing, Inventory, Delivery & Lifecycle Information:

## ABLIC:

[S-8356M50MC-MFJT2G](#) [S-8358B33MC-NQST2G](#) [S-8357F33MC-MGST2G](#) [S-8357B33MC-NIST2G](#) [S-8355K18MC-NADT2G](#) [S-8355M18MC-MCDT2G](#) [S-8356M18MC-MEDT2G](#) [S-8356K18MC-NEDT2G](#) [S-8358G50MC-MNJT2G](#) [S-8357G50MC-MJJT2G](#) [S-8357B50MC-NJJT2G](#) [S-8357F50MC-MHJT2G](#) [S-8355K20MC-NAFT2G](#) [S-8355K31MC-NAQT2G](#) [S-8355K33MC-NAST2G](#) [S-8355K50MC-NBJT2G](#) [S-8355L15MC-NCAT2G](#) [S-8355L20MC-NCFT2G](#) [S-8355M20MC-MCFT2G](#) [S-8355M31MC-MCQT2G](#) [S-8355M32MC-MCRT2G](#) [S-8355M34MC-MCTT2G](#) [S-8355M50MC-MDJT2G](#) [S-8355M55MC-MDOT2G](#) [S-8355Q15MC-OWAT2G](#) [S-8355Q50MC-OXJT2G](#) [S-8356K50MC-NFJT2G](#) [S-8356M15MC-MEAT2G](#) [S-8356M30MC-MEPT2G](#) [S-8356Q18MC-OYDT2G](#) [S-8356Q33MC-OYST2G](#) [S-8356Q50MC-OVJT2G](#) [S-8357B25MC-NIKT2G](#) [S-8357B26MC-NILT2G](#) [S-8357B27MC-NIMT2G](#) [S-8357B28MC-NINT2G](#) [S-8357B30MA-NIPT2G](#) [S-8357B30MC-NIPT2G](#) [S-8357B33MA-NIST2G](#) [S-8357B33UA-NIST2G](#) [S-8357B36MC-NIVT2G](#) [S-8357B48MC-NJHT2G](#) [S-8357B48UA-NJHT2G](#) [S-8357B50MA-NJJT2G](#) [S-8357B50UA-NJJT2G](#) [S-8357B52MC-NJLT2G](#) [S-8357B54MC-NJNT2G](#) [S-8357B60MC-NJTT2G](#) [S-8357E15MC-NKAT2G](#) [S-8357E20MC-NKFT2G](#) [S-8357E50MC-NLJT2G](#) [S-8357F32MC-MGRT2G](#) [S-8357F52MC-MHLT2G](#) [S-8357H30MC-NMPT2G](#) [S-8357H31MC-NMQT2G](#) [S-8357H35MC-NMUT2G](#) [S-8357H36MC-NMVT2G](#) [S-8357H50MC-NNJT2G](#) [S-8357J25MC-NOKT2G](#) [S-8357J50MC-NPJT2G](#) [S-8357N33MC-O2ST2G](#) [S-8357N50MC-O3JT2G](#) [S-8358B23MC-NQIT2G](#) [S-8358B25MC-NQKT2G](#) [S-8358B26MC-NQLT2G](#) [S-8358B27MC-NQMT2G](#) [S-8358B30MC-NQPT2G](#) [S-8358B31MC-NQQT2G](#) [S-8358B32MC-NQRT2G](#) [S-8358B33UA-NQST2G](#) [S-8358B35MC-NQUT2G](#) [S-8358B36MC-NQVT2G](#) [S-8358B38MC-NQXT2G](#) [S-8358B40MC-NQZT2G](#) [S-8358B50MA-NRJT2G](#) [S-8358B50MC-NRJT2G](#) [S-8358B50UA-NRJT2G](#) [S-8358B60MC-NRTT2G](#) [S-8358E20MC-NSFT2G](#) [S-8358E50MC-NTJT2G](#) [S-8358F26MC-MKLT2G](#) [S-8358F27MC-MKMT2G](#) [S-8358F33MC-MKST2G](#) [S-8358F50MC-MLJT2G](#) [S-8358F53MC-MLMT2G](#) [S-8358H23MC-NUIT2G](#) [S-8358H30MC-NUPT2G](#) [S-8358H33MC-NUST2G](#) [S-8358H50MC-NVJT2G](#) [S-8358J33MC-NWST2G](#) [S-8358J50MC-NXJT2G](#) [S-8358N53MC-O7MT2G](#) [S-8356Q40MC-OYZT2G](#) [S-8355M60MC-MDTT2G](#) [S-8355M65MC-MDYT2G](#) [S-8355Q18MC-OWDT2G](#) [S-8355Q20MC-OWFT2G](#) [S-8355Q45MC-OXET2G](#) [S-8355Q51MC-OXKT2G](#) [S-8355Q60MC-OXTT2G](#)

Компания «Океан Электроники» предлагает заключение долгосрочных отношений при поставках импортных электронных компонентов на взаимовыгодных условиях!

Наши преимущества:

- Поставка оригинальных импортных электронных компонентов напрямую с производств Америки, Европы и Азии, а так же с крупнейших складов мира;
- Широкая линейка поставок активных и пассивных импортных электронных компонентов (более 30 млн. наименований);
- Поставка сложных, дефицитных, либо снятых с производства позиций;
- Оперативные сроки поставки под заказ (от 5 рабочих дней);
- Экспресс доставка в любую точку России;
- Помощь Конструкторского Отдела и консультации квалифицированных инженеров;
- Техническая поддержка проекта, помощь в подборе аналогов, поставка прототипов;
- Поставка электронных компонентов под контролем ВП;
- Система менеджмента качества сертифицирована по Международному стандарту ISO 9001;
- При необходимости вся продукция военного и аэрокосмического назначения проходит испытания и сертификацию в лаборатории (по согласованию с заказчиком);
- Поставка специализированных компонентов военного и аэрокосмического уровня качества (Xilinx, Altera, Analog Devices, Intersil, Interpoint, Microsemi, Actel, Aeroflex, Peregrine, VPT, Syfer, Eurofarad, Texas Instruments, MS Kennedy, Miteq, Cobham, E2V, MA-COM, Hittite, Mini-Circuits, General Dynamics и др.);

Компания «Океан Электроники» является официальным дистрибьютором и эксклюзивным представителем в России одного из крупнейших производителей разъемов военного и аэрокосмического назначения «**JONHON**», а так же официальным дистрибьютором и эксклюзивным представителем в России производителя высокотехнологичных и надежных решений для передачи СВЧ сигналов «**FORSTAR**».



## JONHON

«**JONHON**» (основан в 1970 г.)

Разъемы специального, военного и аэрокосмического назначения:

(Применяются в военной, авиационной, аэрокосмической, морской, железнодорожной, горно- и нефтедобывающей отраслях промышленности)

«**FORSTAR**» (основан в 1998 г.)

ВЧ соединители, коаксиальные кабели,  
кабельные сборки и микроволновые компоненты:

(Применяются в телекоммуникациях гражданского и специального назначения, в средствах связи, РЛС, а так же военной, авиационной и аэрокосмической отраслях промышленности).



Телефон: 8 (812) 309-75-97 (многоканальный)

Факс: 8 (812) 320-03-32

Электронная почта: [ocean@oceanchips.ru](mailto:ocean@oceanchips.ru)

Web: <http://oceanchips.ru/>

Адрес: 198099, г. Санкт-Петербург, ул. Калинина, д. 2, корп. 4, лит. А