

---

## 30 V Input 3 A Buck DC/DC Converter

---

NO.EA-191-151211

### OUTLINE

The R1242S is a CMOS-based 30 V input, 3 A, synchronous rectified step-down DC/DC converter with built-in High-side switch. The R1242S contains Nch High-side Tr. (Typ. 0.1  $\Omega$ ) and can supply maximum 3 A output current. In order to reduce heat generation caused by energy loss, FET can be used as Low-side switch. Low-side switch turns off when ICs shut down. The R1242S consists of the followings: an oscillator, a PWM control circuit, a voltage reference unit, an error amplifier, a phase compensation circuit, a slope control circuit, a soft-start circuit, protection circuits, an internal regulator, a switch, and so on. Also, the R1242S consists of the following external components: an inductor, resistors, an external FET, and capacitors.

The R1242S operates with current mode topology, which does not require any sense resistor. As a result, the R1242S can achieve high speed and high efficiency. The oscillator frequencies for each version are set as follows; adjustable between 330 kHz to 1000 kHz for versions A and B, 330 kHz for versions C and D, 500 kHz for versions E and F, and 1000 kHz for versions G and H.

The R1242S is equipped with the protection functions, such as peak current limit function, latch function, fold back function, thermal-shutdown function, and undervoltage-lockout (UVLO) function. Peak current limit function restricts the maximum current into 4.5 A. Latch function (comes with versions A, C, E, and G) shuts off the output if current limit detection continues for a certain period of time. Fold back function (comes with versions B, D, F, and H) reduces the initial oscillator frequencies into 1/4 when output is short-circuited.

### FEATURES

- Supply Current..... Typ. 0.8 mA ( $V_{IN} = 30$  V, Set  $V_{FB} = 1.0$  V)
- Standby Current..... Typ. 0  $\mu$ A ( $V_{IN} = 30$  V, CE = L)
- Input Voltage Range ..... 5 V to 30 V
- Output Voltage Range ..... 0.8 V to 15 V, Adjustable using external resistors
- Feed Back Voltage Accuracy..... 0.8 V with 1.5% accuracy
- Output Current ..... 3 A\*
- Oscillator Frequency..... 330 kHz to 1 MHz (Ver. A/B), 330 kHz (Ver. C/D),  
500 kHz, (Ver. E/F), 1000 kHz (Ver. G/H)
- Maximum Duty Cycle..... Typ. 88%
- UVLO Detector Threshold ..... Typ. 3.6 V
- Soft-start Time ..... Typ. 0.5 ms
- Peak Current Limit..... Typ. 4.5 A
- Thermal Shutdown..... Typ. 160°C
- Latch Type Protection..... Delay Time: Typ. 5 ms (Ver. A/C/E/G)
- Fold-back Type Protection..... Fold-back Frequency: Ver. B: fosc x 1/4,  
Ver. D: 83 kHz, Ver. F: 125 kHz, Ver. H: 250 kHz
- Package..... HSOP-8E

\* This is an approximate value. The output current depends on conditions and external parts.

# R1242S

NO.EA-191-151211

## APPLICATIONS

- Digital Home Appliances: Digital TVs, DVD Players
- Office Automation Equipment: Printers, Fax
- Hand-held Communication Equipment: Cameras, Video Recorders
- Battery-powered Equipment

## BLOCK DIAGRAM

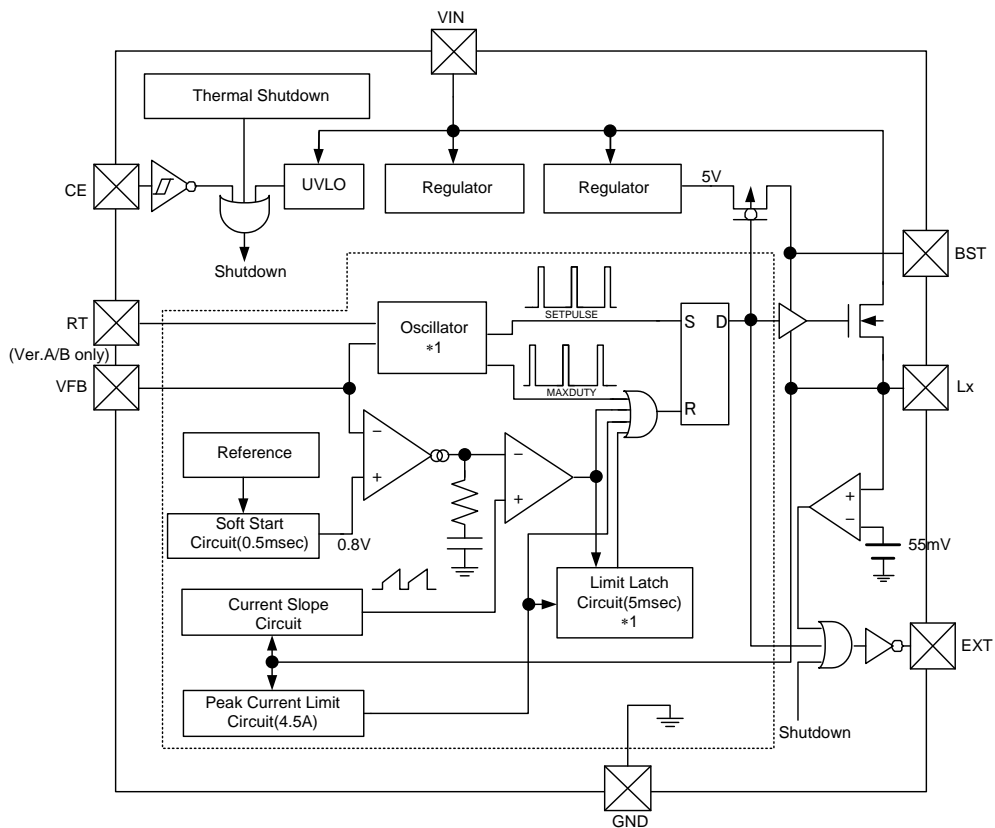

R1242S Block Diagram

\*1

Version	Oscillator Frequency	Short Protection
A	Adjustable	Latch Type
B	Adjustable	Fold-back Type
C	330 kHz	Latch Type
D	330 kHz	Fold-back Type
E	500 kHz	Latch Type
F	500 kHz	Fold-back Type
G	1000 kHz	Latch Type
H	1000 kHz	Fold-back Type

## SELECTION GUIDE

The oscillator frequency (Adjustable, Fixed: 330 kHz, 500 kHz, 1000 kHz) and the short-circuit protection type (Latch, Fold-back) are user-selectable options.

### Selection Guide

Product Name	Package	Quantity per Reel	Pb Free	Halogen Free
R1242S001*-E2-FE	HSOP-8E	1,000 pcs	Yes	Yes

\* : Specify the oscillator frequency and the short-circuit protection type.

Code	Frequency	Latch Type	Fold-back Type
A	Adjustable	Yes	No
B	Adjustable	No	Yes
C	330 kHz	Yes	No
D	330 kHz	No	Yes
E	500 kHz	Yes	No
F	500 kHz	No	Yes
G	1000 kHz	Yes	No
H	1000 kHz	No	Yes

# R1242S

NO.EA-191-151211

## PIN DESCRIPTIONS

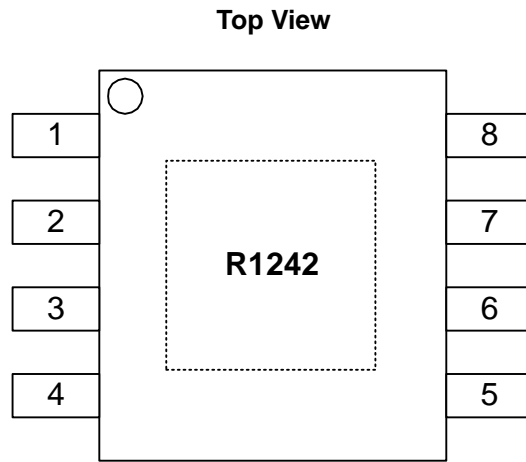

**HSOP-8E Pin Configuration**

### R1242S001A/B Pin Description

Pin No.	Symbol	Description
1	CE	Chip Enable Pin, Active with "H"
2	EXT	Gate Drive Pin
3	BST	Bootstrap Pin
4	VIN	Power Supply Pin
5	Lx	Lx Switching Pin
6	GND	Ground Pin
7	VFB	Feedback Pin
8	RT	Frequency Setting Pin

\* Tab is GND level. (They are connected to the reverse side of this IC.) The tab must be connected to the GND.

### R1242S001C/D/E/F/G/H Pin Description

Pin No.	Symbol	Description
1	CE	Chip Enable Pin, Active with "H"
2	EXT	Gate Drive Pin
3	BST	Bootstrap Pin
4	VIN	Power Supply Pin
5	Lx	Lx Switching Pin
6	GND	Ground Pin
7	VFB	Feedback Pin
8	TEST	TEST Pin, OPEN or connect to GND

\* Tab is GND level. (They are connected to the reverse side of this IC.) The tab must be connected to the GND.

## ABSOLUTE MAXIMUM RATINGS

### Absolute Maximum Ratings

(GND = 0 V)

Symbol	Item	Rating	Unit
$V_{IN}$	Input Voltage	-0.3 V ~ 32 V	V
$V_{BST}$	Boost Pin Voltage	$V_{LX} - 0.3 \text{ V} \sim V_{LX} + 6 \text{ V}$	V
$V_{LX}$	Lx Pin Voltage	-0.3 V ~ $V_{IN} + 0.3$	V
$V_{CE}$	CE Pin Input Voltage	-0.3 V ~ $V_{IN} + 0.3$	V
$V_{FB}$	VFB Pin Voltage	-0.3 V ~ 6 V	V
$V_{EXT}$	EXT Pin Voltage	-0.3 V ~ 6 V	V
$V_{RT} / V_{TEST}$	RT/ TEST Pin Voltage	-0.3 V ~ 6 V	V
$P_D$	Power Dissipation (Standard Land Pattern)*	2.9	W
$T_a$	Operating Temperature Range	-40 ~ 85	°C
$T_{stg}$	Storage Temperature Range	-55 ~ 125	°C

\* For Power Dissipation, please refer to PACKAGE INFORMATION.

### ABSOLUTE MAXIMUM RATINGS

Electronic and mechanical stress momentarily exceeded absolute maximum ratings may cause the permanent damages and may degrade the life time and safety for both device and system using the device in the field. The functional operation at or over these absolute maximum ratings is not assured.

### RECOMMENDED OPERATING CONDITIONS (ELECTRICAL CHARACTERISTICS)

All of electronic equipment should be designed that the mounted semiconductor devices operate within the recommended operating conditions. The semiconductor devices cannot operate normally over the recommended operating conditions, even if when they are used over such conditions by momentary electronic noise or surge. And the semiconductor devices may receive serious damage when they continue to operate over the recommended operating conditions.

## ELECTRICAL CHARACTERISTICS

## Electrical Characteristics

(Unless otherwise noted,  $V_{IN} = 12\text{ V}$ ,  $T_a = 25^\circ\text{C}$ )

Symbol	Item	Conditions	Min.	Typ.	Max.	Unit
$V_{IN}$	Operating Input Voltage		5.0		30	V
$I_{IN}$	VIN Consumption Current	$V_{IN} = 30\text{ V}$ , $V_{FB} = 1.0\text{ V}$	0.45	0.80	1.20	mA
$V_{UVLO2}$	UVLO Detect Voltage	Rising	$V_{UVLO2}$ -0.5		$V_{UVLO2}$ -0.3	V
$V_{UVLO1}$	UVLO Released Voltage	Falling	3.7	4.0	4.3	V
$V_{FB}$	VFB Voltage Tolerance		0.788	0.800	0.812	V
$\Delta V_{FB}/\Delta T_a$	VFB Voltage Temperature Coefficient	$-40^\circ\text{C} \leq T_a \leq 85^\circ\text{C}$		$\pm 100$		ppm/ °C
fosc	Oscillator Frequency (Ver. A/B)	RT = GND	900	1000	1100	kHz
		RT = floating	290	330	375	kHz
		RT = 120 k $\Omega$	450	500	550	kHz
	Oscillator Frequency (Ver. C/D)		300	330	370	kHz
	Oscillator Frequency (Ver. E/F)		450	500	550	kHz
f <sub>FLB</sub>	Fold back Frequency	$V_{FB} < 0.56$ , RT = GND (Ver. B)		250		kHz
		$V_{FB} < 0.56$ (Ver. D)		83		kHz
		$V_{FB} < 0.56$ (Ver. F)		125		kHz
		$V_{FB} < 0.56$ (Ver. H)		250		kHz
Maxduty	Maximum Duty Cycle	RT = 120 k $\Omega$ (Ver. A/B) $V_{IN} = 9\text{ V}$ (Ver. C/D)	82	88	95	%
tstart	Soft Start Time			0.5		ms
tDLY	Delay Time for Latch Protection	(Ver. A/C/E/G)		5		ms
r <sub>LXH</sub>	Lx High Side Switch ON Resistance			0.1		$\Omega$
I <sub>LXHOFF</sub>	Lx High Side Switch Leakage Current			0	20	$\mu\text{A}$
I <sub>LIMLXH</sub>	Lx High Side Switch Limited Current			4.5		A
V <sub>CEH</sub>	CE "H" Input Voltage		1.7			V
V <sub>CEL</sub>	CE "L" Input Voltage				0.4	V
I <sub>FB</sub>	VFB Input Current		-1.0		1.0	$\mu\text{A}$
I <sub>CEH</sub>	CE "H" Input Current		-1.0		1.0	$\mu\text{A}$
I <sub>CEL</sub>	CE "L" Input Current		-1.0		1.0	$\mu\text{A}$
T <sub>TSD</sub>	Thermal Shutdown Detect Temperature	Hysteresis: 30°C		160		°C
Istandby	Standby Current	$V_{IN} = 30\text{ V}$ , $V_{CE} = 0\text{ V}$		0	20	$\mu\text{A}$
R <sub>RISE</sub>	EXT "H" Switch On Resistance	$I_{EXT} = -100\text{ mA}$	6		11	$\Omega$
R <sub>FALL</sub>	EXT "L" Switch On Resistance	$I_{EXT} = 100\text{ mA}$	0.5		1.5	$\Omega$
V <sub>EXTLIM</sub>	Detecting Voltage for Low Side Switch Current Limit		36	55	76	mV

## TYPICAL APPLICATIONS

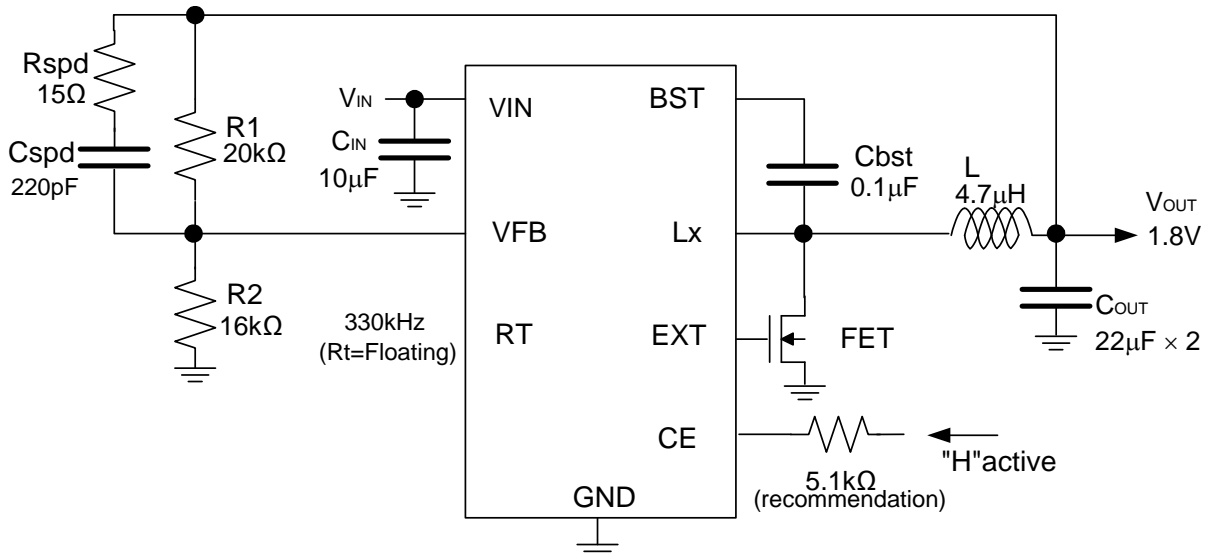
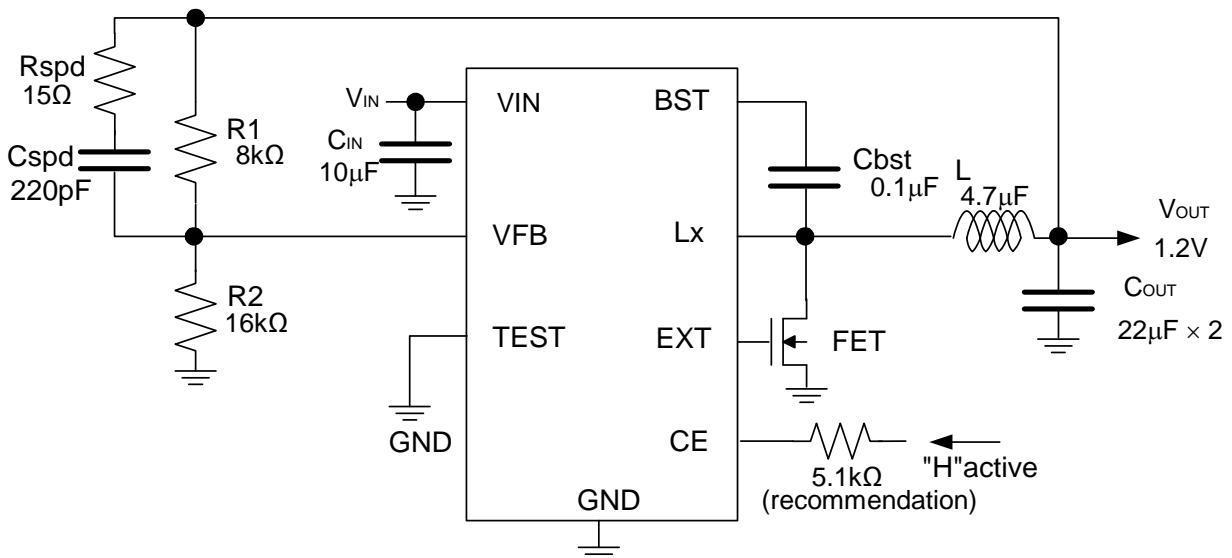
R1242S001A/B Typical Application,  $V_{OUT} = 1.8\text{ V}$ , 330 kHzR1242S001C/D Typical Application,  $V_{OUT} = 1.2\text{ V}$ , 330 kHz

## Recommendation Parts

$C_{IN}$	10 $\mu\text{F}$ , KTS500B106M55N0T00 (Nippon Chemi-Con)
$C_{OUT}$	22 $\mu\text{F}$ , GRM31CR71A226M (Murata)
$C_{bst}$	0.1 $\mu\text{F}$ , GRM21BB11H104KA01L (Murata)
L	4.7 $\mu\text{H}$ , VLF10045T-4R7N6R1 (TDK)
FET	TPC8031 (TOSHIBA)

# R1242S

NO.EA-191-151211

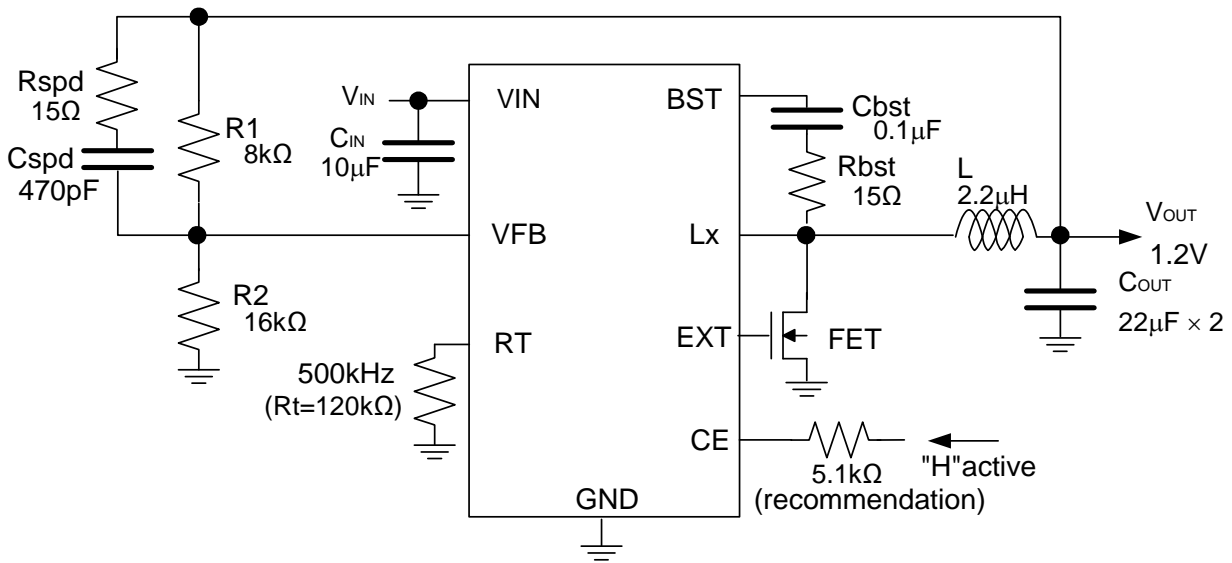

**R1242S001A/B Typical Application,  $V_{OUT} = 1.2\text{ V}$ , 500 kHz**

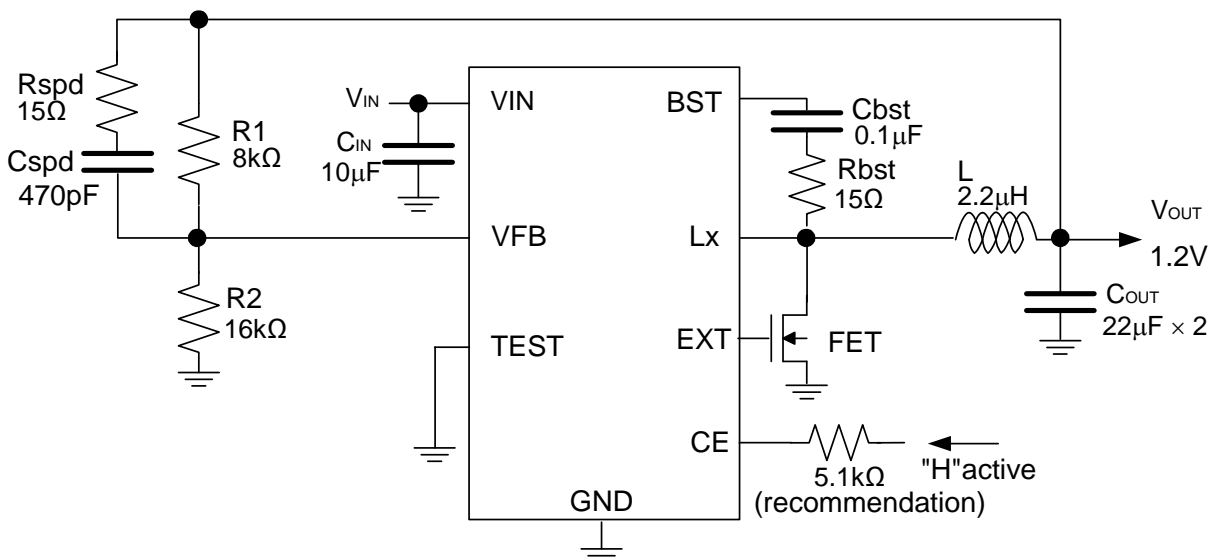

**R1242S001E/F Typical Application,  $V_{OUT} = 1.2\text{ V}$ , 500 kHz**

## Recommendation Parts

$C_{IN}$	10 $\mu\text{F}$ , KTS500B106M55N0T00 (Nippon Chemi-Con)
$C_{OUT}$	22 $\mu\text{F}$ , GRM31CR71A226M (Murata)
$C_{bst}$	0.1 $\mu\text{F}$ , GRM21BB11H104KA01L (Murata)
L	2.2 $\mu\text{H}$ , RLF7030T-2R2M5R4 (TDK)
FET	TPC8031 (TOSHIBA)



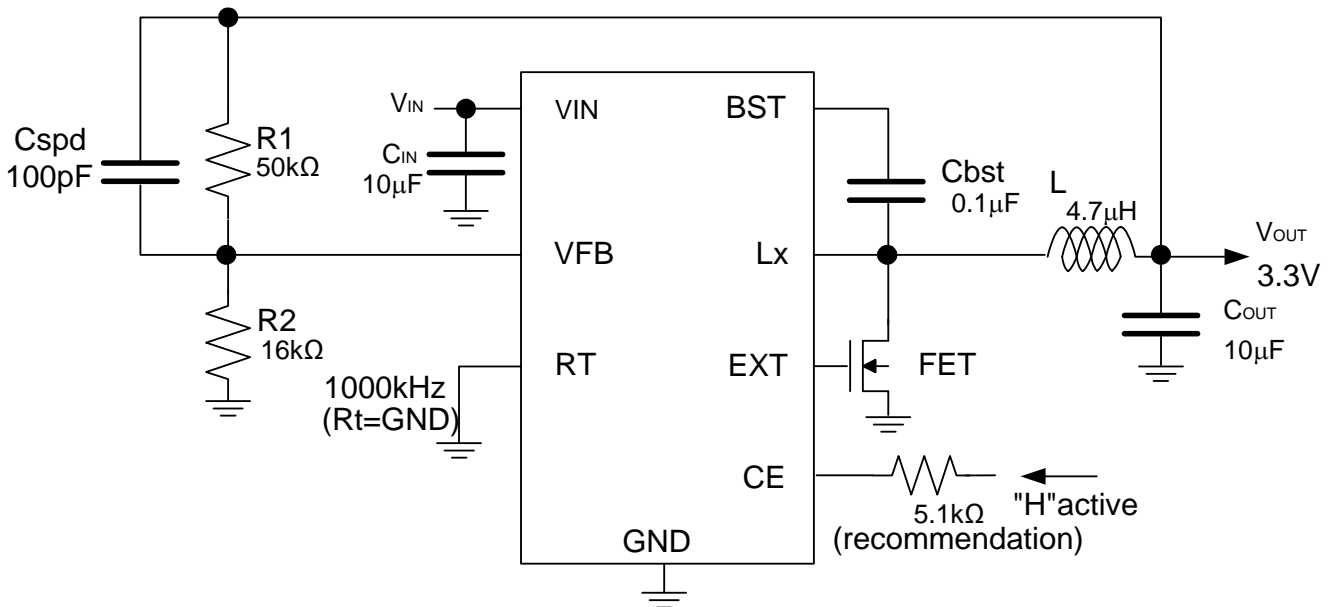

R1242S001A/B Typical Application,  $V_{OUT} = 3.3\text{ V}$ , 1000 kHz

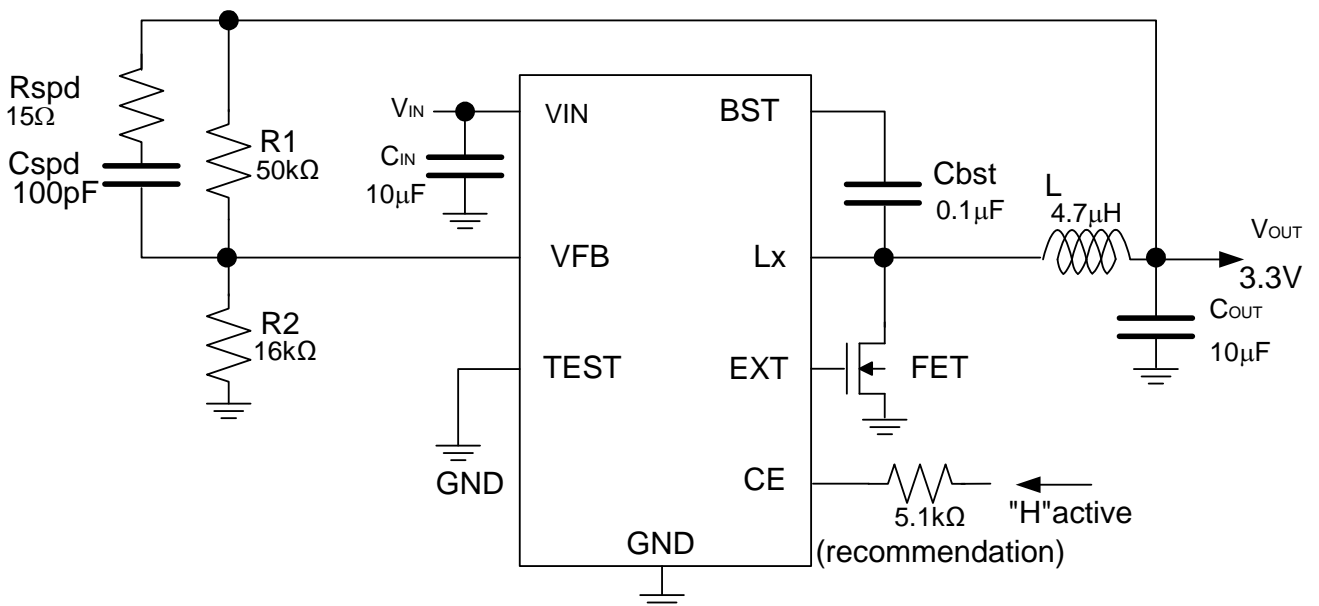

R1242S001G/H Typical Application,  $V_{OUT} = 3.3\text{ V}$ , 1000 kHz

**Recommendation Parts**

$C_{IN}$	10 $\mu\text{F}$ , KTS500B106M55N0T00 (Nippon Chemi-Con)
$C_{OUT}$	10 $\mu\text{F}$ , GRM31CR71E106K (Murata)
$C_{bst}$	0.1 $\mu\text{F}$ , GRM21BB11H104KA01L (Murata)
L	4.7 $\mu\text{H}$ , VLF10045T-4R7N6R1 (TDK)
FET	SSM3K14T (TOSHIBA)

## TECHNICAL NOTES

- External components must be connected as close as possible to the ICs and their wiring must be short as possible. Especially, the capacitor must be connected with the shortest distance between  $V_{IN}$  and GND pins. If the impedances of the power supply line and the GND line are high, the operation can be unstable due to the switching current which fluctuates the electric potential of the inside the ICs. The impedances of power supply line and GND line must be as low as possible. When designing their wirings, it is necessary to give careful consideration to the large current flowing into the power supply, GND, Lx, VOUT and inductor. The wiring of output voltage setting resistance (R1) and the wiring of inductor must be separated from load wiring.
- The ceramic capacitors with low ESR (Equivalent Series Resistance) must be used for the ICs. The recommended value for the  $C_{IN}$  capacitor between VIN and GND is equal or more than 10  $\mu$ F.
- The selections of inductor (L) and output capacitor ( $C_{OUT}$ ) can be different according to the ICs' oscillation frequencies, output voltages and input voltages. Refer to "Recommended Value for Each Output Voltage" on the next page and select the most suitable values at the conditions of use. The internal phase compensation is built in the ICs; therefore, if the values selected are largely deviated from the recommended values, the operation may result in unstable.
- The over current protection circuit could be influenced by self-heating of the ICs and heat dissipation of the PCB environment.
- In order to prevent self-turning on, FET with smaller gate resistance and with smaller Cgd/ Cgs (capacities between gate drains and the capacities between gate sources) should be selected.
- The output voltage ( $V_{OUT}$ ) can be calculated as  $V_{OUT} = V_{FB} \times (R1 + R2) / R2$ . The various voltage settings are possible by changing the values of R1 and R2. However, R2 value must be equal or less than 16 k $\Omega$ .
- Rspd prevents the deterioration in the regulation characteristics, which is caused by spike noise occurred in  $V_{OUT}$ . Spike noise is largely depending on the PCB layout. If the PCB board layout is optimized, there is no need of Rspd; however, if the spike noise is a concern, Rspd with 15  $\Omega$  or so should be used.
- After the completion of soft start, latch function (Ver. A, C, E, G) starts to work. The internal counter starts counting up when the over current protection circuit activates the limited current detection. When the internal counter counts up to 5ms, which is a typical delay time for latch protection, the latch function turns off the output. The turned off output can be reset when CE pin is changed to "L", and also  $V_{IN}$  pin voltage is became less than 3.6 V (Typ.), which is UVLO detecting voltage. If the output voltage increases more than the setting voltage (VFB pin voltage is 0.8 V (Typ.)) within the delay time for latch protection, the counter restores the default. If the power-supply voltage's start-up is slow and the output voltage is not reached to the setting voltage within the delay time for latch protection after the soft start, the careful attention is required.
- After the soft start, fold back function (Ver. B, D, F, H) starts to work. The fold back function limits the oscillation frequencies into 1/4 when (VFB pin voltage decreases to less than 0.56 V (Typ.)). If the power-supply voltage's start-up is slow and the output voltage is not reached to the 70% of the setting voltage even for a short period of time after the soft start, the careful attention is required.
- The ICs are not supporting Nonsynchronous rectification using a diode as a rectifier.
- The table on the next page shows the recommended values for setting frequency and setting output voltage.

## Recommended Values

330 kHz

V <sub>OUT</sub> [V]	0.8	1.2	1.2	1.5	1.5	1.8	1.8	2.5	2.5	3.3	5	9	15
V <sub>IN</sub> Range [V]	5~14	~12	9~30	5~10	10~30	5~15	12~30	5~15	12~30	5~30	7~30	15~30	20~30
L [ $\mu$ H]	2.2	10	4.7	10	4.7	15	4.7	15	10	15	15	15	15
C <sub>OUT</sub> [ $\mu$ F]	100	22	44	22	44	22	44	22	22	22	22	22	22
Cspd [pF]	-	470	470	220	220	470	220	220	220	220	220	220	220->100
R1 [ $\Omega$ ]	-	8000	8000	14000	14000	20000	20000	34000	34000	50000	84000	164000	284000
R2 [ $\Omega$ ]	-	16000	16000	16000	16000	16000	16000	16000	16000	16000	16000	16000	16000

500 kHz

V <sub>OUT</sub> [V]	0.8	1.0	1.2	1.5	1.5	1.8	1.8	2.5	3.3	5	9	12	15
V <sub>IN</sub> Range [V]	~9	~10	5~15	5~18	7~19	5~23	9~21	5~29	5~30	7~30	15~30	18~30	20~30
L [ $\mu$ H]	2.2	2.2	2.2	4.7	2.2	4.7	2.2	10	10	10	10	15	15
C <sub>OUT</sub> [ $\mu$ F]	100	44	44	44	44	44	44	22	22	22	22	22	22
Cspd [pF]	-	1000	470	220	220	220	220	220	220	220	220	220	220
R1 [ $\Omega$ ]	-	4000	8000	14000	14000	20000	20000	34000	50000	84000	164000	224000	284000
R2 [ $\Omega$ ]	-	16000	16000	16000	16000	16000	16000	16000	16000	16000	16000	16000	16000

1000 kHz

V <sub>OUT</sub> [V]	0.8	1.2	1.5	1.8	2.5	3.3	5	5	9	15
V <sub>IN</sub> Range [V]	5~7	5~10	5~15	5~15	5~19	5~30	7~12	12~30	15~30	20~30
L [ $\mu$ H]	1.5	2.2	2.2	4.7	4.7	4.7	4.7	4.7	4.7	10
C <sub>OUT</sub> [ $\mu$ F]	100	22	22	22	22	10	10	10	10	10
Cspd [pF]	-	220	100	220	220	100	100	56	56	100
R1 [ $\Omega$ ]	-	8000	14000	20000	34000	50000	84000	84000	164000	284000
R2 [ $\Omega$ ]	-	16000	16000	16000	16000	16000	16000	16000	16000	16000

---

**R1242S**

---

NO.EA-191-151211

**Recommended External Components**

Symbol	Condition	Value	Parts Name	MFR
C <sub>IN</sub>		10 $\mu$ F/ 50 V	UMK325BJ106MM-P	TAIYO YUDEN
		10 $\mu$ F/ 50 V	CGA6P3X7S1H106K	TDK
		10 $\mu$ F/ 50 V	KTS500B106M55N0T00	Nippon Chemi-Con
		10 $\mu$ F/ 10 V	GRM31CR71A106K	Murata
C <sub>OUT</sub>	V <sub>OUT</sub> > 10 V	10 $\mu$ F/ 50 V	KTS500B106M55N0T00	Nippon Chemi-Con
	10 V > V <sub>OUT</sub> > 1.8 V	10 $\mu$ F/ 25 V	GRM31CR71E106K	Murata
	V <sub>OUT</sub> < 1.8 V	22 $\mu$ F/ 10 V	GRM31CR71A226M	Murata
			(at the diode rectifier, the specified condition only)	
C <sub>BST</sub>		0.1 $\mu$ F/ 50 V	GRM21BB11H104KA01L	Murata
L	1.5 $\mu$ H $\pm$ 30%/ 4.0 A	1.5 $\mu$ H	SLF7055T-3PF-1R5N4R0	TDK
	2.2 $\mu$ H $\pm$ 20%/ 5.4 A	2.2 $\mu$ H	RLF7030T-2R2M5R4	TDK
	4.7 $\mu$ H $\pm$ 30%/ 6.1 A	4.7 $\mu$ H	VLF10045T-4R7N6R1	TDK
	10 $\mu$ H $\pm$ 20% 6.2 A	10 $\mu$ H	VLF12060T-100M6R2	TDK
	15 $\mu$ H $\pm$ 20% 5.0 A	15 $\mu$ H	VLF12060T-150M5R0	TDK
FET	30 V/ 4 A	57 m $\Omega$	SSM3K14T	TOSHIBA
	30 V/ 13 A	14.3 m $\Omega$	TPCC8003-H	TOSHIBA
	30 V/ 11 A	9.8 m $\Omega$	TPCP8005-H	TOSHIBA
	30 V/ 11 A	10.1 m $\Omega$	TPC8031-H	TOSHIBA
R <sub>CE</sub>	The diode is connected between CE pin and VIN pin as an ESD protection element.			
	If there is a possibility that the CE pin voltage becomes higher than the VIN pin voltage,			
	it is recommended to insert a 5 k $\Omega$ resistance or more in order to prevent the large current			
	flowing from CE pin into VIN pin.			

## THE VOLTAGE BETWEEN THE BST PIN AND LX PIN

In the application of the "Bootstrap" Start switching regulator, the R1242S, when the Lx pin voltage becomes equal or less than the BST voltage supply regulator, the BST voltage supply regulator charges the capacitor, C<sub>bst</sub>. By this function, even if the Lx pin becomes "H", the high side switch composed of an Nch transistor can be turned on.

Under the condition of PWM operation, the BST voltage supply regulator of the R1242S, while the Lx pin voltage is "L", the voltage between BST pin and GND pin is controlled and maintained the level as of 5 V, then regardless of the voltage drop by the bootstrap switch, the BST voltage supply regulator can drive a high side switch and the low side external MOSFET.

However, if either the maximum duty cycle limit or the low side switch current limit is detected, sampling of the voltage between BST pin and Lx pin is halted, and the output of the BST voltage supply regulator becomes stacked at 5 V as same as a conventional "Bootstrap" Start switching regulator. Depending on the external FET gate capacitance, excessive voltage drop can be caused by bootstrap switching, and also switching failure can be caused by insufficient electrical charge on C<sub>bst</sub>. As a result, the desired voltage may not be obtained. Higher frequency requires higher electrical charge. Special attention is required in case of using the device at 1000 kHz.

Events that may trigger such trouble are

- (A) Detect of the current limit of low side switch at light load
- (B)  $V_{OUT} > V_{IN} / 2$  and starting the circuit without using CE pin individually or CE pin and VIN are tied and controlled at the same time.
- (C) The voltage difference between the input and the output is small and usage at maximum duty cycle is expected.

The countermeasure to avoid the trouble caused by the events above is to use an external diode, Dbst shown in the figure below. The Dbst will charge C<sub>BST</sub> and prevents the abnormal switching. The supply voltage to Dbst should be in the range from 4.5 V to 6.0 V and if the set output voltage of the R1242S is in the range from 4.5 V to 6.0 V, then the output voltage can be used directly as the supply voltage of Dbst. The voltage rating of the diode, Dbst must be  $V_{IN}$  or more, the forward current of Dbst must be 20 mA or more. Other specifications of the Dbst are not important.

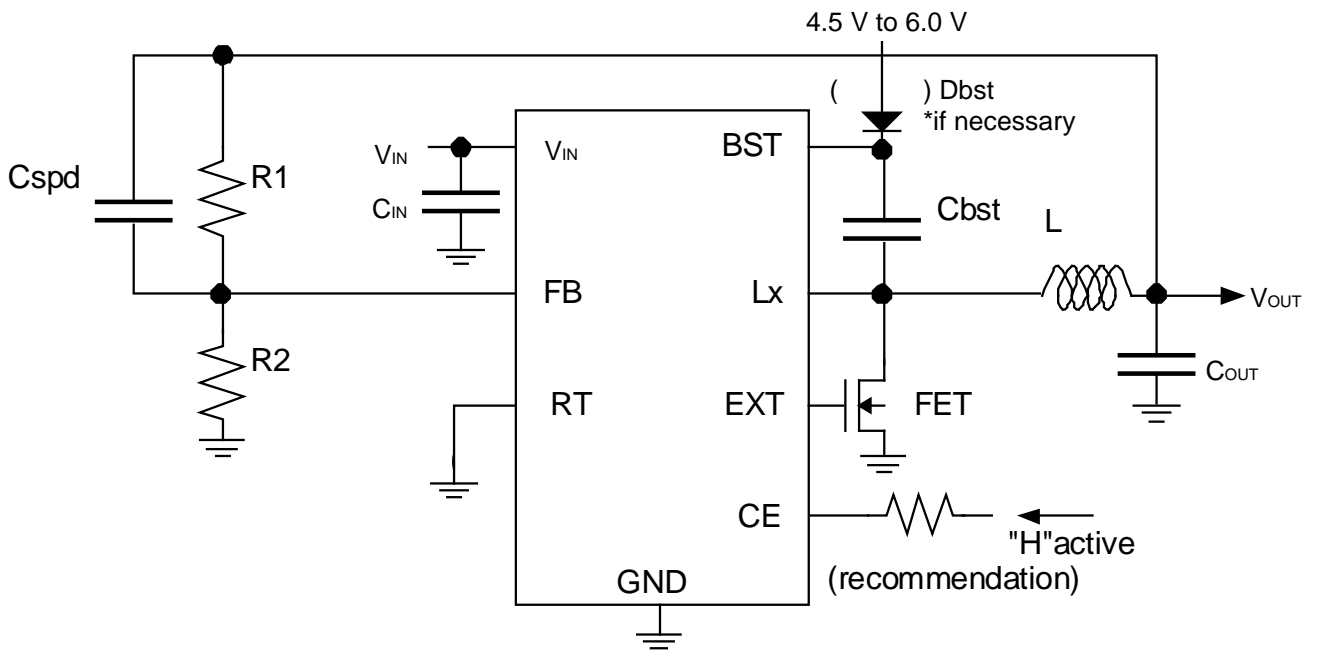

Application Circuit Example

If the auxiliary power source for BST 4.5 V to 6.0 V does not have a bypass capacitor, set 0.1  $\mu$ F or higher bypass capacitor between the auxiliary power source and GND.

## OPERATING FREQUENCY (Ver. A/B)

In the application circuit of the R1242S001A/B, the 330 kHz operation is selected by leaving  $R_t$  open. Connecting a 200 k $\Omega$  to 0  $\Omega$  resistor between  $R_t$  (pin 8) and ground can be used to set the switching frequency to approximately 450 kHz to 1000 kHz. To calculate the  $R_t$  resistor, use the equation below:

\*(Between 330 kHz and 450 kHz switching frequency can be also set by connecting the appropriate resistor according to the next equation.)

$$R_t = 120000 / (2 / (1000000 / f_{osc} - 1) - 1) [\Omega]$$

The switching frequency vs.  $R_t$  value is shown in Figure 1 and Figure 2.

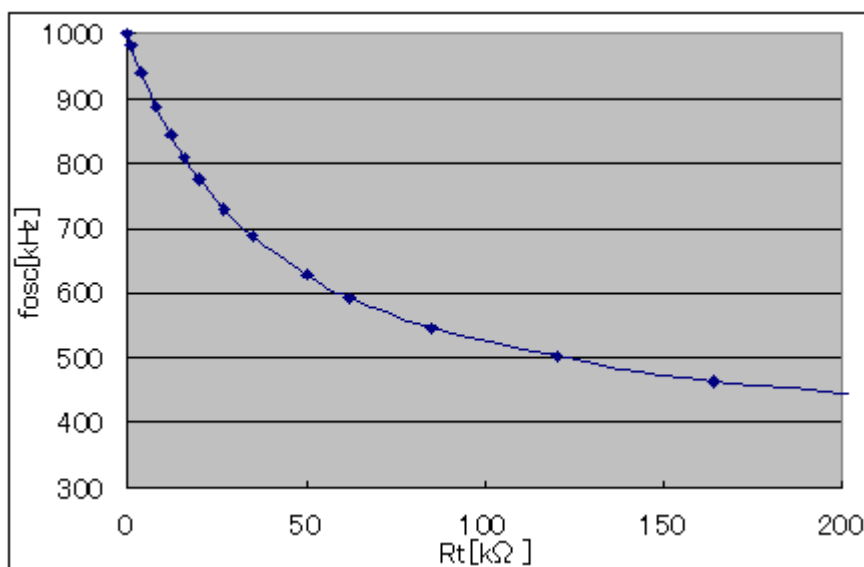

Figure 1. Linearscale

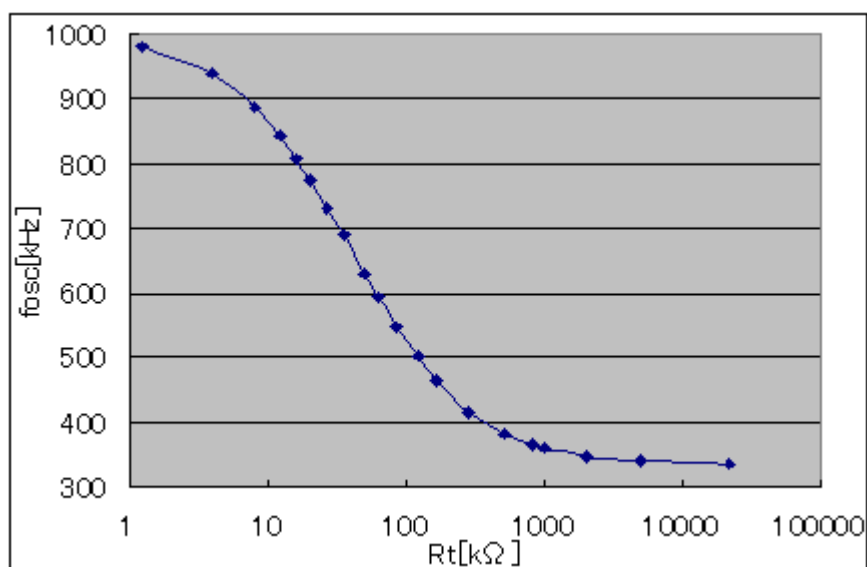
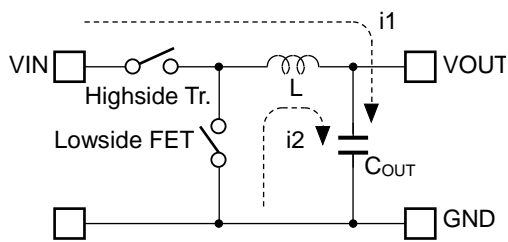

Figure 2. Logscale

## OPERATION OF STEP-DOWN DC/DC CONVERTER AND OUTPUT CURRENT

The step-down DC/DC converter charges energy in the inductor (L) when the Lx transistor turns on, and discharges the energy from the inductor when Lx transistor turns off and controls with less energy loss, so that a lower output voltage ( $V_{OUT}$ ) than the input voltage ( $V_{IN}$ ) can be obtained. The operation of the step-down DC/DC converter is explained in the following figures.



Basic Circuit

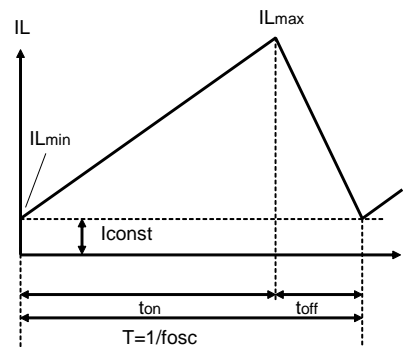

Inductor Current flowing through Inductor

- Step1.** The highside transistor turns on and the inductor current ( $i_1$ ) flows, L is charged with energy. At this moment,  $i_1$  increases from the minimum inductor current ( $I_{Lmin}$ ), which is 0 A, and reaches the maximum inductor current ( $I_{Lmax}$ ) in proportion to the on-time period ( $t_{on}$ ) of the highside transistor.
- Step2.** When the highside transistor turns off, L tries to maintain  $I_L$  at  $I_{Lmax}$ , so L turns the lowside FET on and the inductor current ( $i_2$ ) flows into L.
- Step3.**  $i_2$  decreases gradually and reaches  $I_{Lmin}$  in proportion to the off-time period ( $t_{off}$ ) of the highside transistor.

In the case of PWM mode,  $V_{OUT}$  is maintained by controlling  $t_{on}$ . During PWM mode, the oscillator frequency ( $f_{osc}$ ) is being maintained constant.

When the step-down DC/DC operation is constant,  $I_{Lmin}$  and  $I_{Lmax}$  during  $t_{on}$  of highside transistor would be same as during  $t_{off}$  of highside transistor.



## OUTPUT CURRENT AND SELECTION OF EXTERNAL COMPONENTS

The following equations explain the relationship between output current and peripheral components.

Ripple Current P-P value is described as  $I_{RP}$ , ON resistance of Highside Tr. is described as  $R_{ONH}$ , ON resistance of Lowside FET is described as  $R_{ONL}$ , and DC resistance of the inductor is described as  $R_L$ .

First, when Highside Tr. is "ON", the following equation is satisfied.

$$V_{IN} = V_{OUT} + (R_{ONH} + R_L) \times I_{OUT} + L \times I_{RP} / t_{on} \dots \dots \dots \text{Equation 3}$$

Second, when Highside Tr. is "OFF" (Lowside FET is "ON"), the following equation is satisfied.

$$L \times I_{RP} / t_{off} = R_{ONL} \times I_{OUT} + V_{OUT} + R_L \times I_{OUT} \dots \dots \dots \text{Equation 4}$$

Put Equation 4 into Equation 3 to solve ON duty of Highside Tr. ( $D_{ON} = t_{on} / (t_{off} + t_{on})$ ):

$$D_{ON} = (V_{OUT} + (R_{ONL} + R_L) \times I_{OUT}) / V_{IN} + (R_{ONL} - R_{ONH}) \times I_{OUT} \dots \dots \dots \text{Equation 5}$$

Ripple Current is described as follows:

$$I_{RP} = (V_{IN} - V_{OUT} - R_{ONH} \times I_{OUT} - R_L \times I_{OUT}) \times D_{ON} / f_{osc} / L \dots \dots \dots \text{Equation 6}$$

Peak current that flows through L, and  $L_X$  Tr. is described as follows:

$$I_{Lmax} = I_{OUT} + I_{RP} / 2 \dots \dots \dots \text{Equation 7}$$

Notes: Please consider  $I_{Lmax}$  when setting conditions of input and output, as well as selecting the external components. The above calculation formulas are based on the ideal operation of the ICs in continuous mode.

**TYPICAL CHARACTERISTICS**

**1)FB Voltage**

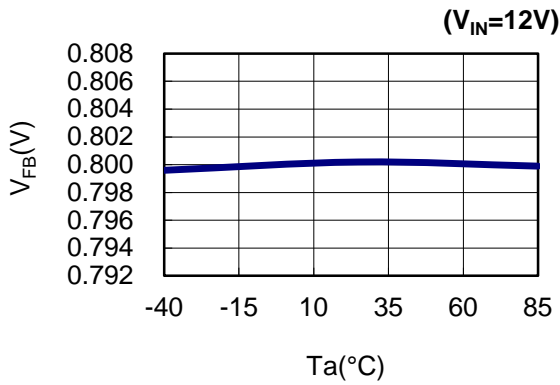

**2)Oscillator Frequency(ver.A,B Rt=floating)**

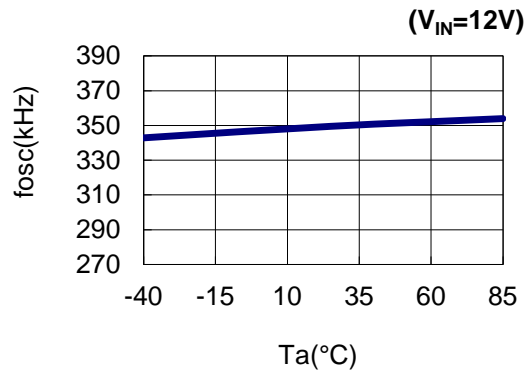

**3)Oscillator Frequency(ver.A,B Rt=GND)**

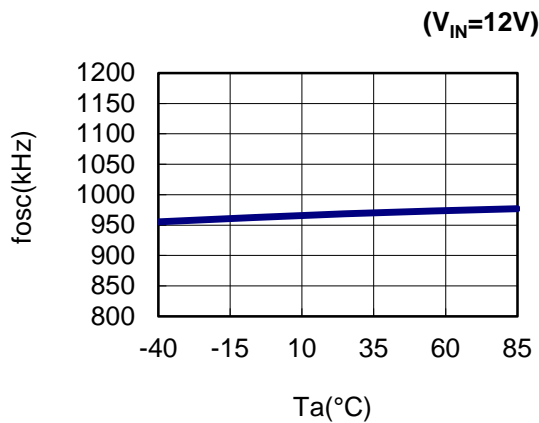

**4)Oscillator Frequency(ver.A,B Rt=120kΩ)**

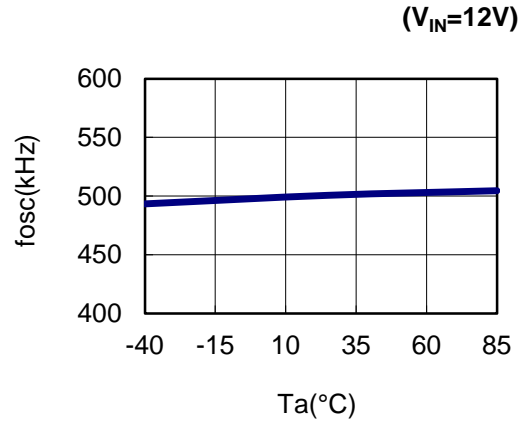

**5)Oscillator Frequency(ver.C,D)**

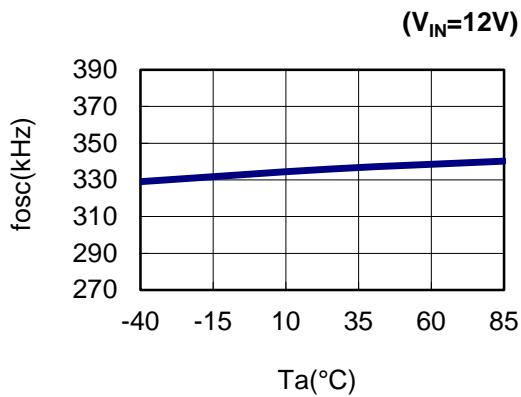

**6) Oscillator Frequency(ver.E,F)**

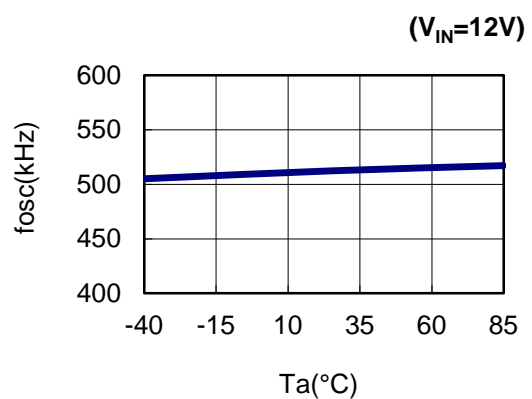

7) Oscillator Frequency(ver.G,H)

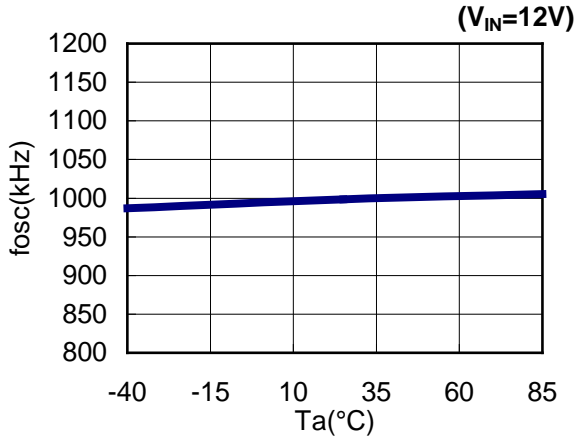

8) Fold-Back Frequency(ver.A,B Rt=GND)

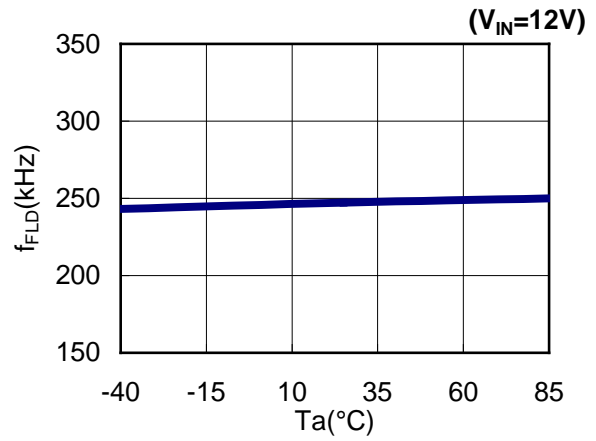

9) Fold-Back Frequency(ver.C,D)

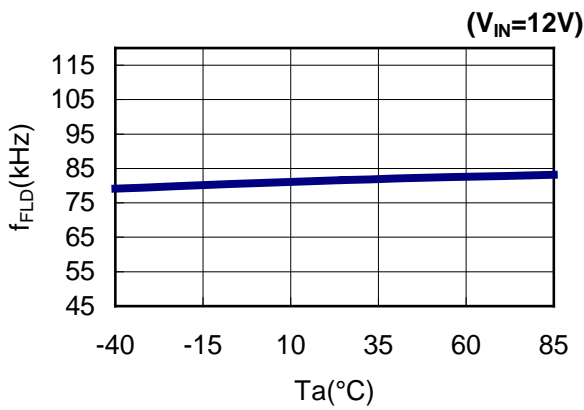

10) Fold-Back Frequency(ver.E,F)

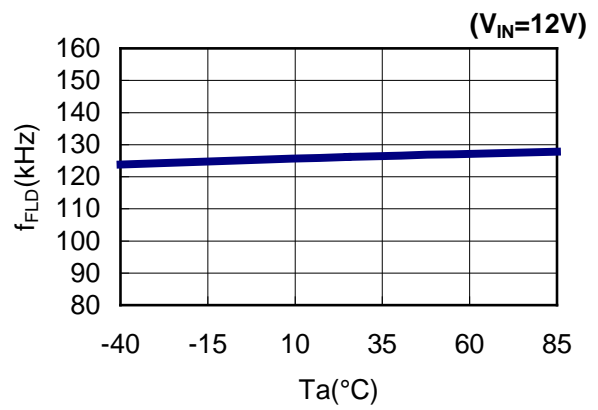

11) Fold-Back Frequency(ver.G,H)

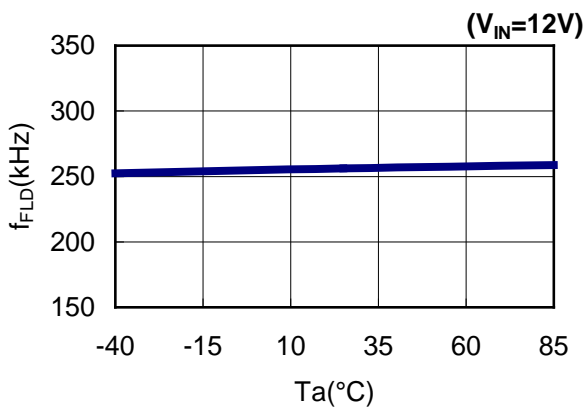

12) Maxduty(ver.A,B Rt=floating)

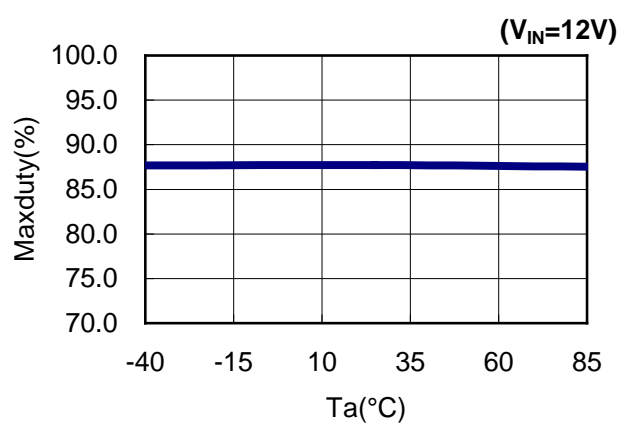

13) Maxduty(ver.C,D)

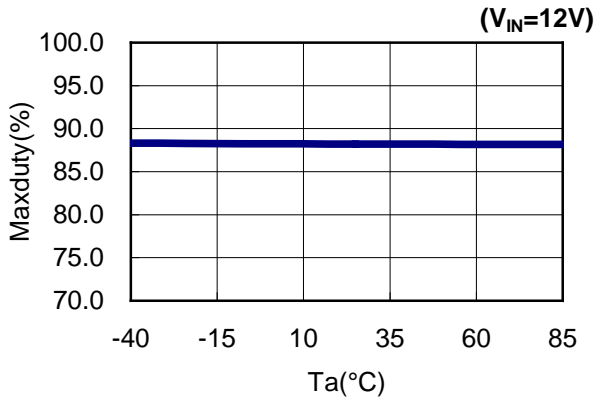

14) Maxduty(ver.G,H)

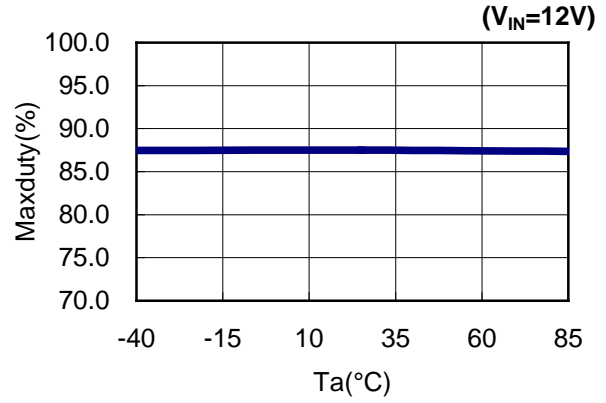

15) Maxduty(ver.A,B Rt=GND)

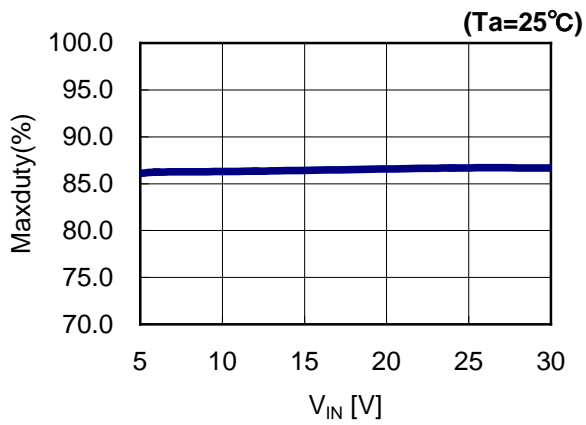

16) Maxduty(ver.C,D)

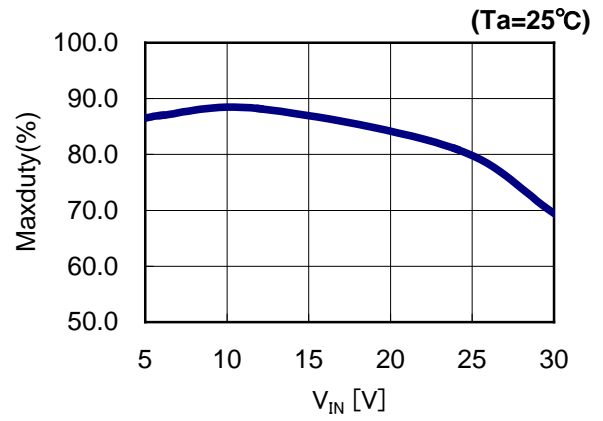

17) Maxduty(ver.G,H)

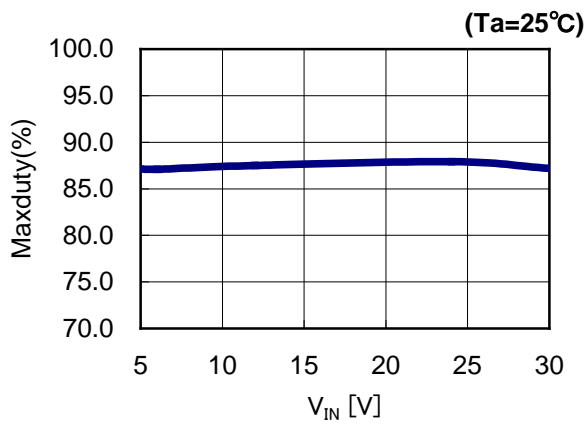

18)Efficiency vs Load Current

fosc=330kHz

V<sub>OUT</sub>:0.8V

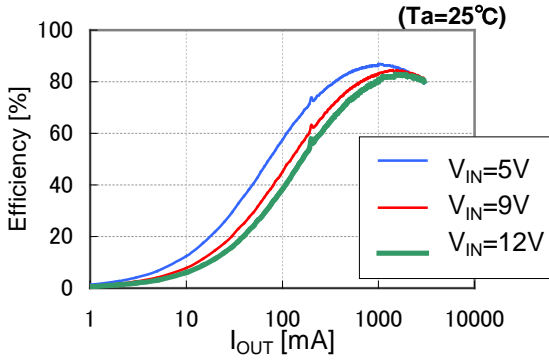

V<sub>OUT</sub>:3.3V

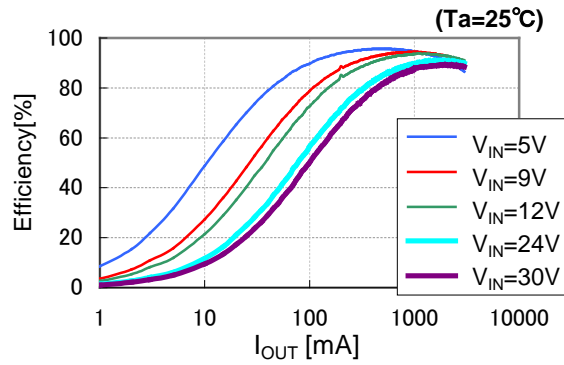

V<sub>OUT</sub>:15V

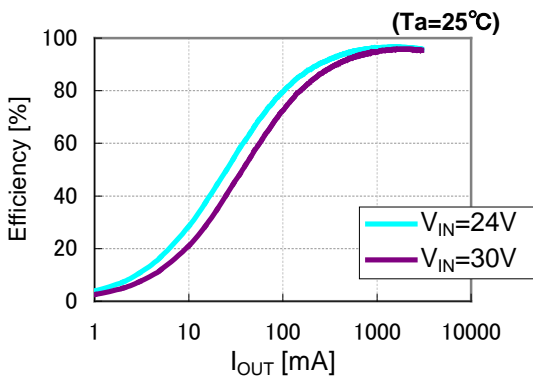

fosc=500kHz

V<sub>OUT</sub>:0.8V

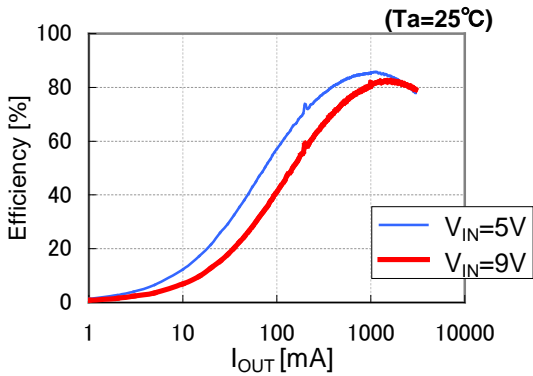

V<sub>OUT</sub>:3.3V

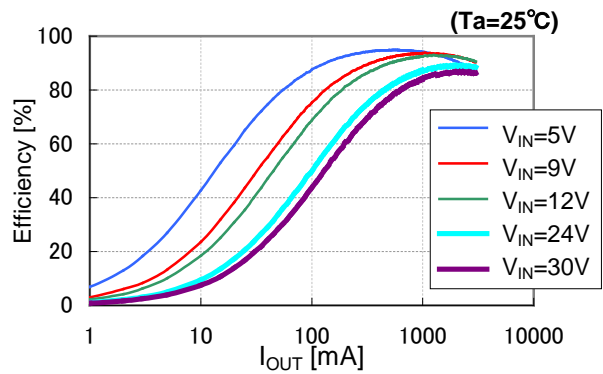

**V<sub>OUT</sub>:15V**

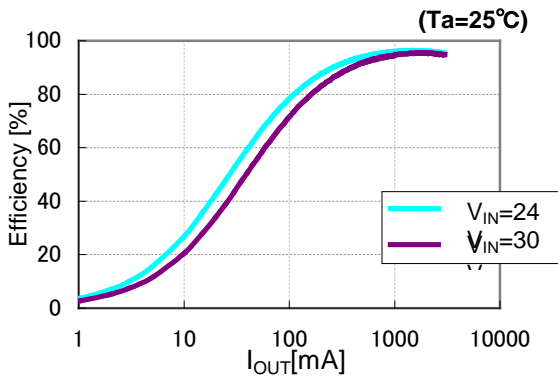

**f<sub>osc</sub>=1000kHz**  
**V<sub>OUT</sub>:0.8V**

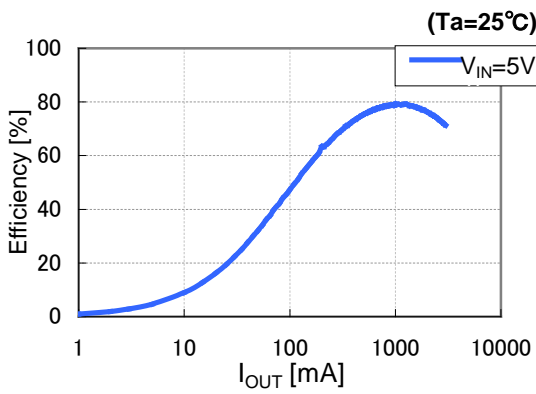

**V<sub>OUT</sub>:3.3V**

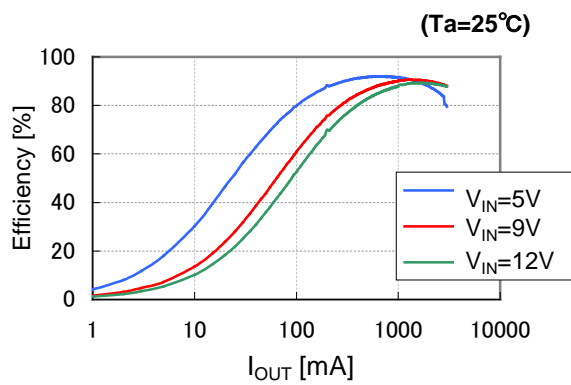

**V<sub>OUT</sub>:15V**

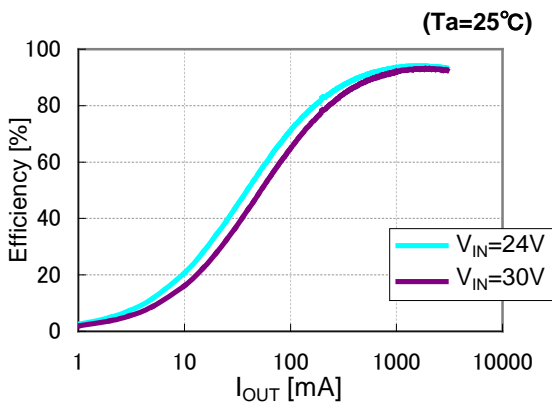

19) Load Regulation

fosc=330kHz

V<sub>OUT</sub>:0.8V

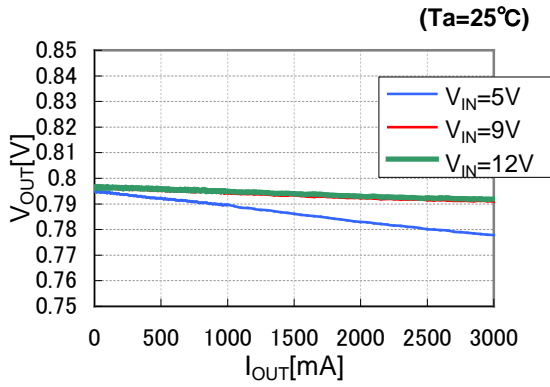

V<sub>OUT</sub>:3.3V

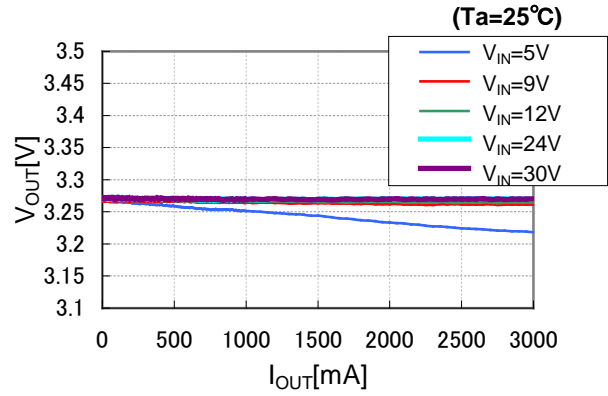

V<sub>OUT</sub>:15V

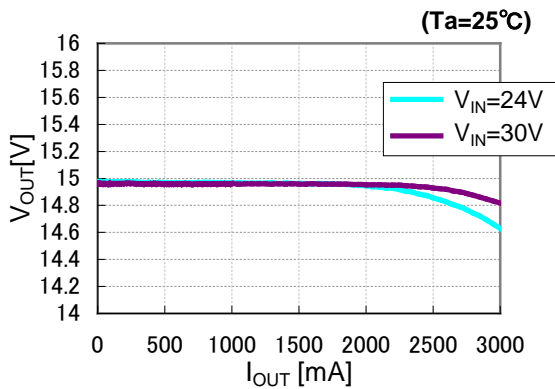

fosc=500kHz

V<sub>OUT</sub>:0.8V

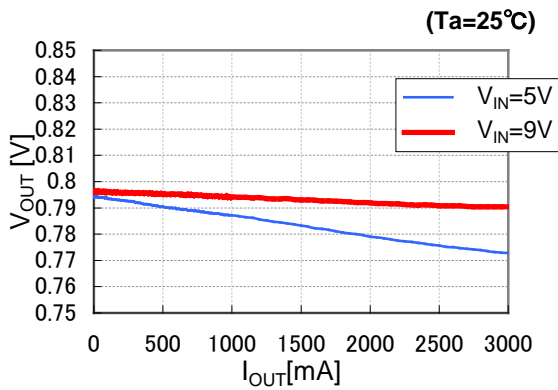

V<sub>OUT</sub>:3.3V

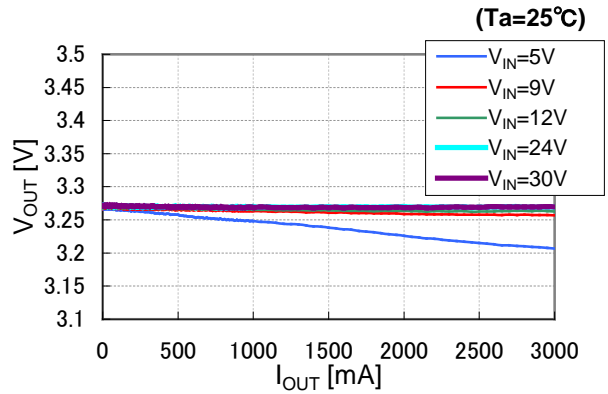

**V<sub>OUT</sub>:15V**

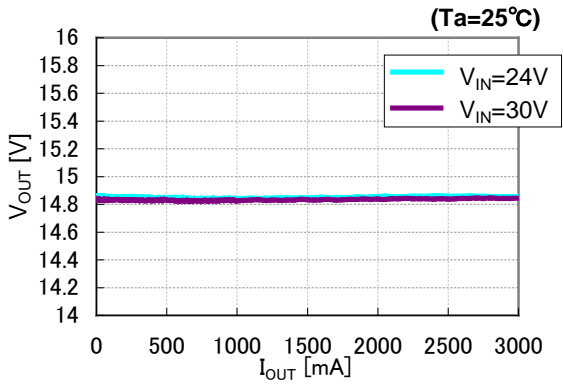

**f<sub>osc</sub>=1000kHz**

**V<sub>OUT</sub>:0.8V**

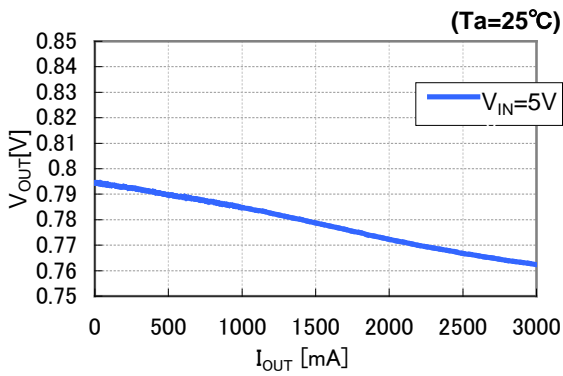

**V<sub>OUT</sub>:3.3V**

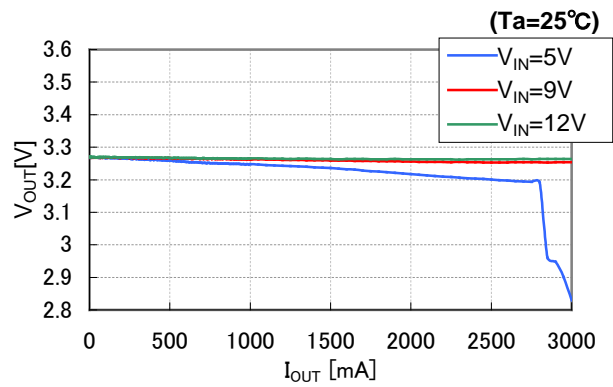

**V<sub>OUT</sub>:15V**

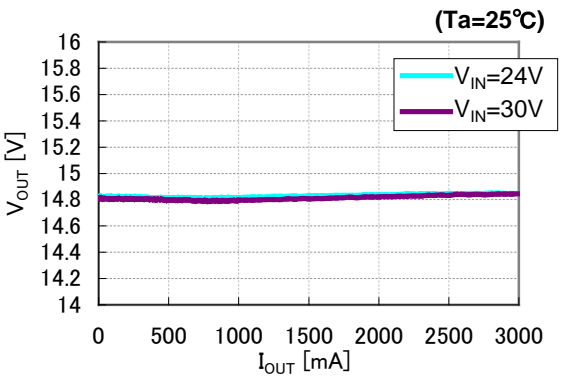



20) Line Regulation

fosc=330kHz

V<sub>OUT</sub>:0.8V

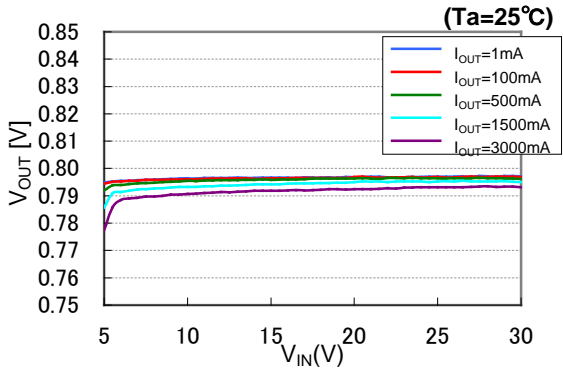

V<sub>OUT</sub>:3.3V

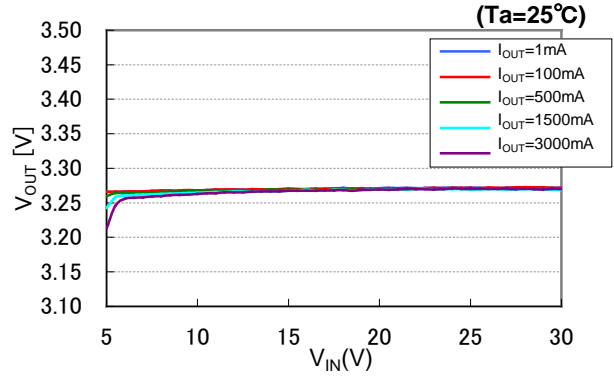

V<sub>OUT</sub>:15V

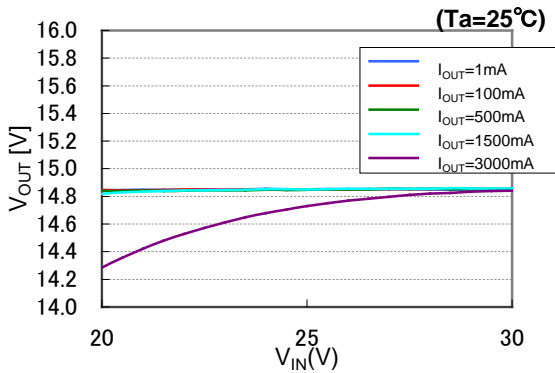

fosc=500kHz

V<sub>OUT</sub>:0.8V

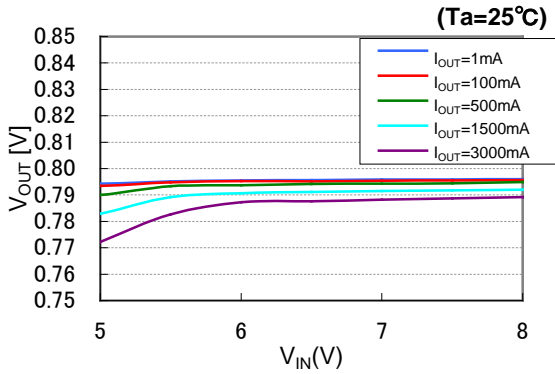

V<sub>OUT</sub>:3.3V

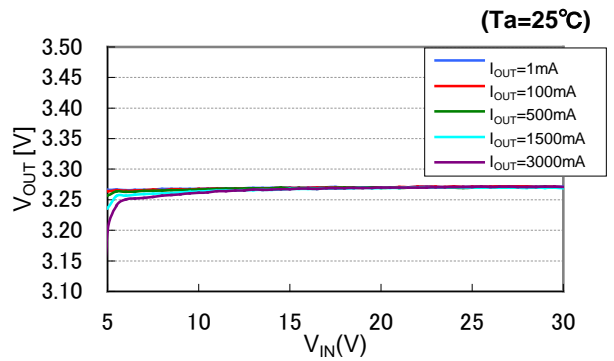

**V<sub>OUT</sub>:15V**

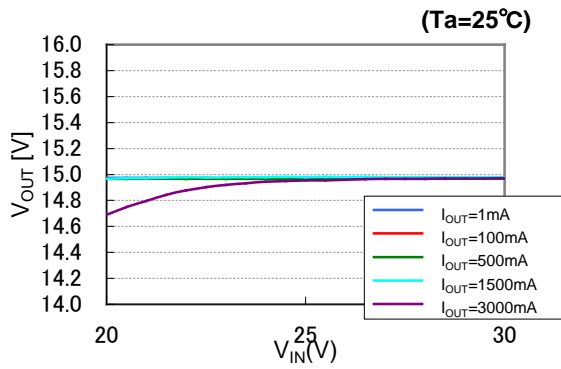

**fosc=1000kHz**

**V<sub>OUT</sub>:0.8V**

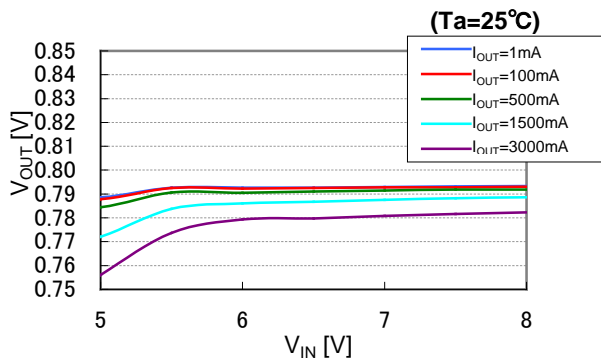

**V<sub>OUT</sub>:3.3V**

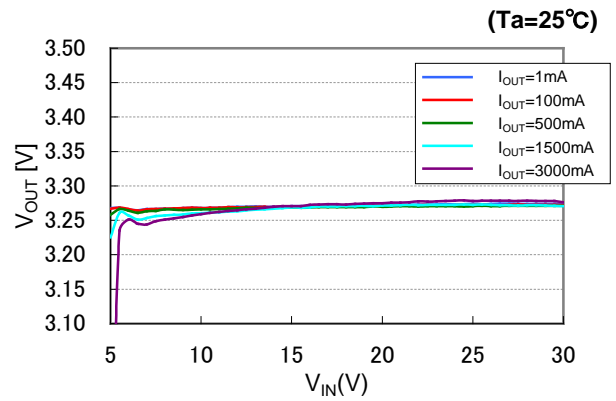

**V<sub>OUT</sub>:15V**

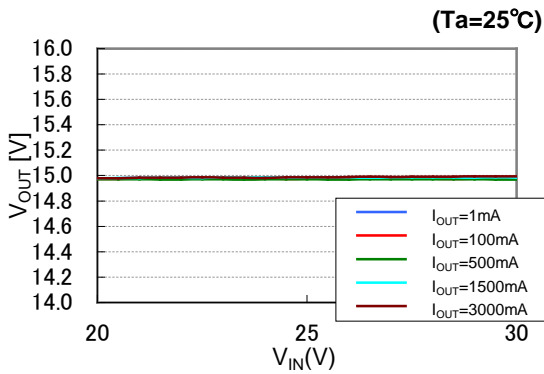



1. The products and the product specifications described in this document are subject to change or discontinuation of production without notice for reasons such as improvement. Therefore, before deciding to use the products, please refer to Ricoh sales representatives for the latest information thereon.
2. The materials in this document may not be copied or otherwise reproduced in whole or in part without prior written consent of Ricoh.
3. Please be sure to take any necessary formalities under relevant laws or regulations before exporting or otherwise taking out of your country the products or the technical information described herein.
4. The technical information described in this document shows typical characteristics of and example application circuits for the products. The release of such information is not to be construed as a warranty of or a grant of license under Ricoh's or any third party's intellectual property rights or any other rights.
5. The products listed in this document are intended and designed for use as general electronic components in standard applications (office equipment, telecommunication equipment, measuring instruments, consumer electronic products, amusement equipment etc.). Those customers intending to use a product in an application requiring extreme quality and reliability, for example, in a highly specific application where the failure or misoperation of the product could result in human injury or death (aircraft, spacevehicle, nuclear reactor control system, traffic control system, automotive and transportation equipment, combustion equipment, safety devices, life support system etc.) should first contact us.
6. We are making our continuous effort to improve the quality and reliability of our products, but semiconductor products are likely to fail with certain probability. In order to prevent any injury to persons or damages to property resulting from such failure, customers should be careful enough to incorporate safety measures in their design, such as redundancy feature, fire containment feature and fail-safe feature. We do not assume any liability or responsibility for any loss or damage arising from misuse or inappropriate use of the products.
7. Anti-radiation design is not implemented in the products described in this document.
8. Please contact Ricoh sales representatives should you have any questions or comments concerning the products or the technical information.



**Ricoh is committed to reducing the environmental loading materials in electrical devices with a view to contributing to the protection of human health and the environment.**

Ricoh has been providing RoHS compliant products since April 1, 2006 and Halogen-free products since April 1, 2012.

**RICOH** RICOH ELECTRONIC DEVICES CO., LTD.

<http://www.e-devices.ricoh.co.jp/en/>

#### Sales & Support Offices

##### **RICOH ELECTRONIC DEVICES CO., LTD.**

**Higashi-Shinagawa Office (International Sales)**  
3-32-3, Higashi-Shinagawa, Shinagawa-ku, Tokyo 140-8655, Japan  
Phone: +81-3-5479-2857 Fax: +81-3-5479-0502

##### **RICOH EUROPE (NETHERLANDS) B.V.**

**Semiconductor Support Centre**  
Prof. W.H. Keesomlaan 1, 1183 DJ Amstelveen, The Netherlands  
Phone: +31-20-5474-309

##### **RICOH INTERNATIONAL B.V. - German Branch**

**Semiconductor Sales and Support Centre**  
Oberrather Strasse 6, 40472 Düsseldorf, Germany  
Phone: +49-211-6546-0

##### **RICOH ELECTRONIC DEVICES KOREA CO., LTD.**

3F, Haesung Bldg, 504, Teheran-ro, Gangnam-gu, Seoul, 135-725, Korea  
Phone: +82-2-2135-5700 Fax: +82-2-2051-5713

##### **RICOH ELECTRONIC DEVICES SHANGHAI CO., LTD.**

Room 403, No.2 Building, No.690 Bibo Road, Pu Dong New District, Shanghai 201203, People's Republic of China  
Phone: +86-21-5027-3200 Fax: +86-21-5027-3299

##### **RICOH ELECTRONIC DEVICES CO., LTD.**

**Taipei office**  
Room 109, 10F-1, No.51, Hengyang Rd., Taipei City, Taiwan (R.O.C.)  
Phone: +886-2-2313-1621/1622 Fax: +886-2-2313-1623

# Mouser Electronics

Authorized Distributor

Click to View Pricing, Inventory, Delivery & Lifecycle Information:

## Ricoh Electronics:

[R1242S001B-E2-FE](#) [R1242S001A-E2-FE](#) [R1242S001F-E2-FE](#) [R1242S001G-E2-FE](#) [R1242S001C-E2-FE](#)  
[R1242S001E-E2-FE](#)

Компания «Океан Электроники» предлагает заключение долгосрочных отношений при поставках импортных электронных компонентов на взаимовыгодных условиях!

Наши преимущества:

- Поставка оригинальных импортных электронных компонентов напрямую с производств Америки, Европы и Азии, а так же с крупнейших складов мира;
- Широкая линейка поставок активных и пассивных импортных электронных компонентов (более 30 млн. наименований);
- Поставка сложных, дефицитных, либо снятых с производства позиций;
- Оперативные сроки поставки под заказ (от 5 рабочих дней);
- Экспресс доставка в любую точку России;
- Помощь Конструкторского Отдела и консультации квалифицированных инженеров;
- Техническая поддержка проекта, помощь в подборе аналогов, поставка прототипов;
- Поставка электронных компонентов под контролем ВП;
- Система менеджмента качества сертифицирована по Международному стандарту ISO 9001;
- При необходимости вся продукция военного и аэрокосмического назначения проходит испытания и сертификацию в лаборатории (по согласованию с заказчиком);
- Поставка специализированных компонентов военного и аэрокосмического уровня качества (Xilinx, Altera, Analog Devices, Intersil, Interpoint, Microsemi, Actel, Aeroflex, Peregrine, VPT, Syfer, Eurofarad, Texas Instruments, MS Kennedy, Miteq, Cobham, E2V, MA-COM, Hittite, Mini-Circuits, General Dynamics и др.);

Компания «Океан Электроники» является официальным дистрибьютором и эксклюзивным представителем в России одного из крупнейших производителей разъемов военного и аэрокосмического назначения «**JONHON**», а так же официальным дистрибьютором и эксклюзивным представителем в России производителя высокотехнологичных и надежных решений для передачи СВЧ сигналов «**FORSTAR**».



## JONHON

«**JONHON**» (основан в 1970 г.)

Разъемы специального, военного и аэрокосмического назначения:

(Применяются в военной, авиационной, аэрокосмической, морской, железнодорожной, горно- и нефтедобывающей отраслях промышленности)

«**FORSTAR**» (основан в 1998 г.)

ВЧ соединители, коаксиальные кабели, кабельные сборки и микроволновые компоненты:

(Применяются в телекоммуникациях гражданского и специального назначения, в средствах связи, РЛС, а так же военной, авиационной и аэрокосмической отраслях промышленности).



Телефон: 8 (812) 309-75-97 (многоканальный)

Факс: 8 (812) 320-03-32

Электронная почта: [ocean@oceanchips.ru](mailto:ocean@oceanchips.ru)

Web: <http://oceanchips.ru/>

Адрес: 198099, г. Санкт-Петербург, ул. Калинина, д. 2, корп. 4, лит. А