

PART NO.	DIM "A"	DESCRIPTION
10081530-1****	12.00	1.5V
10081530-2****	11.00	X.XV
10081530-3****	13.00	X.XV
10081530-4****	12.00	1.5V

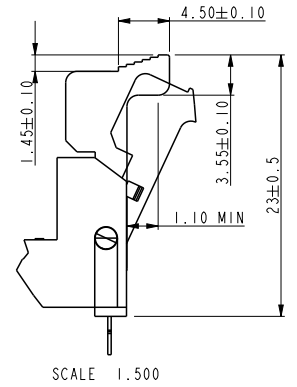

spec ref	*	dr	Rick Bian	2010/07/03	projection	mm	size	A4	scale	0.500											
tolerance std	TOLERANCES UNLESS OTHERWISE SPECIFIED	eng	Jeny Ren	2017/08/07			ecn no	ELX-DG-27598-1													
surface	<table border="1"> <tr> <td>linear</td> <td>0.X</td> <td>±0.38</td> </tr> <tr> <td></td> <td>0.XX</td> <td>±0.25</td> </tr> <tr> <td></td> <td>0.XXX</td> <td>±0.13</td> </tr> <tr> <td>angular</td> <td>0°</td> <td>±2°</td> </tr> </table>	linear	0.X	±0.38				0.XX	±0.25		0.XXX	±0.13	angular	0°	±2°	chr	-	-	product family	-	rel level
linear	0.X	±0.38																			
	0.XX	±0.25																			
	0.XXX	±0.13																			
angular	0°	±2°																			
		appr	Nickor Zuo	2017/08/11			product family	-													
			www.fci.com		title DDR3 R-DIMM CONNECTOR METAL CLIP TYPE		dwg no	10081530			rev	L									
					cat. no.		Product - Customer Drw			sheet 1 of 4											

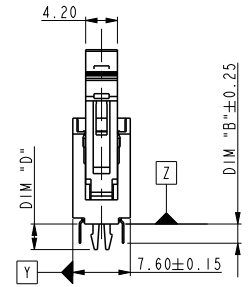
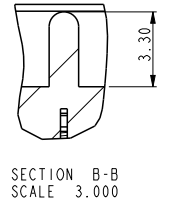
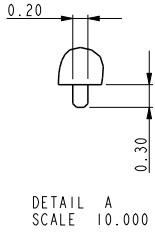
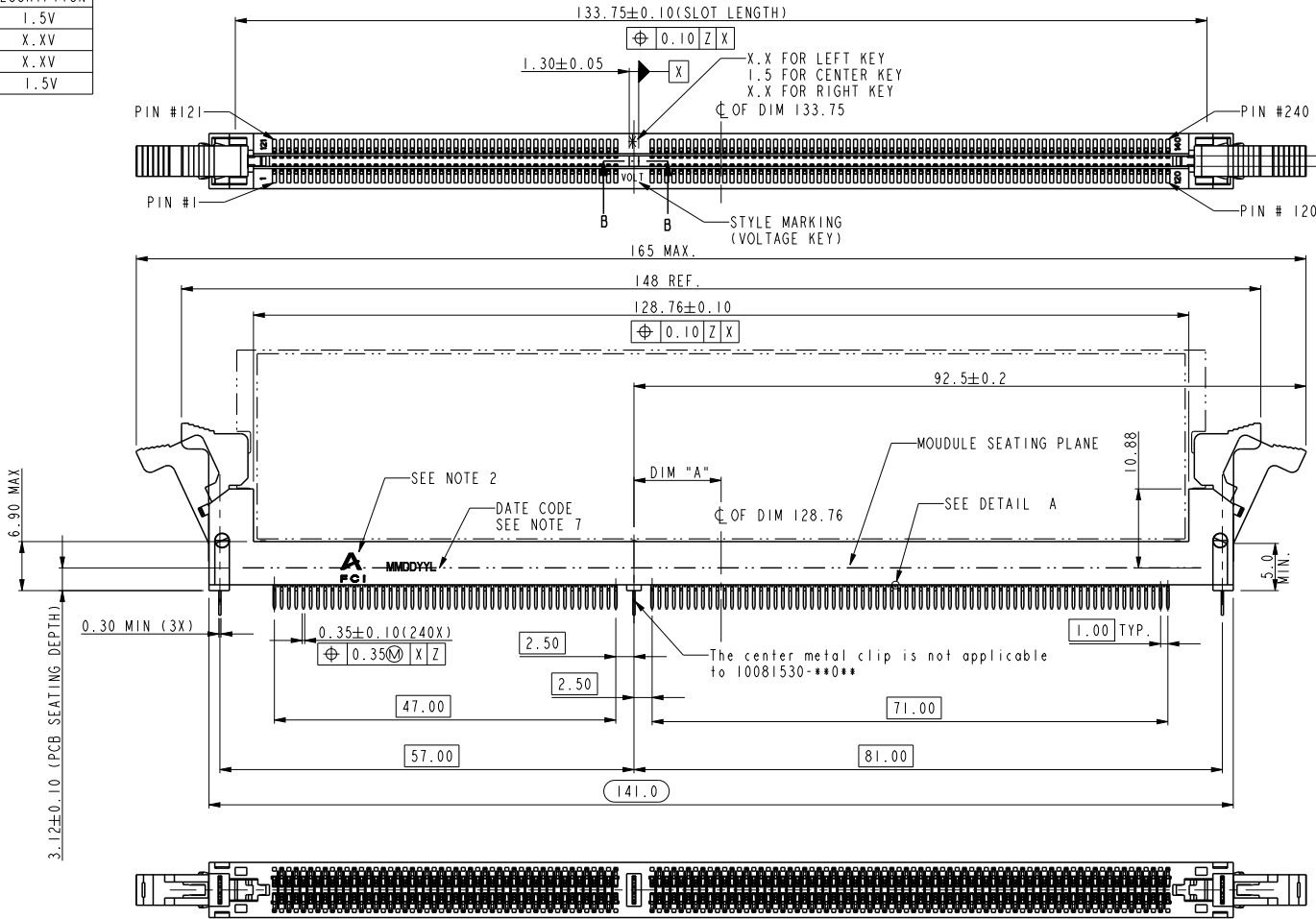
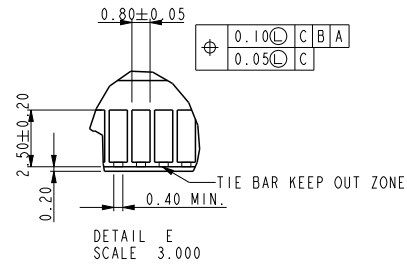
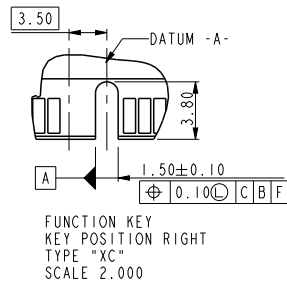
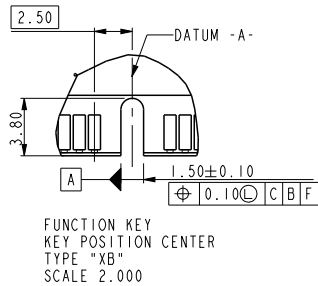
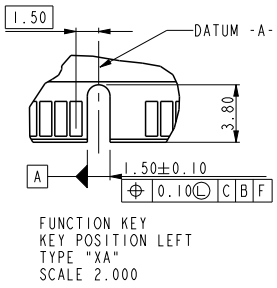
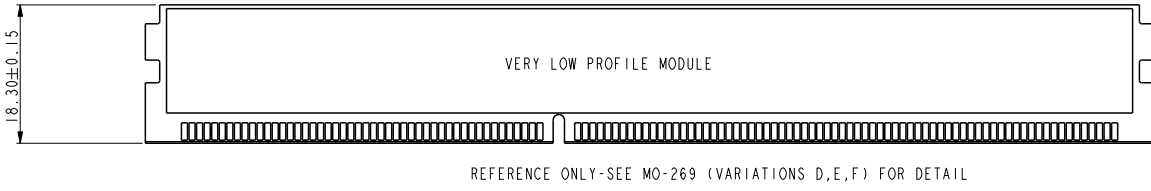
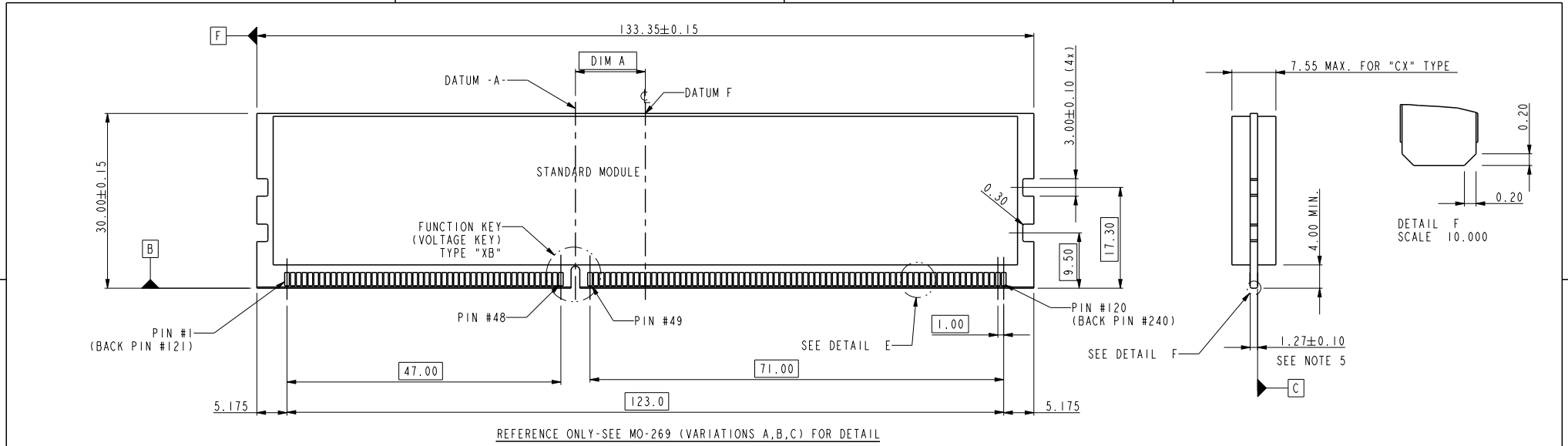

TYPE "XA"	X.X VOLTAGE
TYPE "XC"	X.X VOLTAGE
TYPE "XB"	1.5 VOLTAGE
SUB KEY POS #1	DESCRIPTION

spec ref	*	dr	Rick Bian	2010/07/03	projection	mm	size	A4	scale	0.500											
tolerance std	TOLERANCES UNLESS OTHERWISE SPECIFIED	eng	Jeny Ren	2017/08/07			ecn no	ELX-DG-27598-1													
surface	<table border="1"> <tr> <td>linear</td> <td>0.X</td> <td>±0.38</td> </tr> <tr> <td></td> <td>0.XX</td> <td>±0.25</td> </tr> <tr> <td></td> <td>0.XXX</td> <td>±0.13</td> </tr> <tr> <td>angular</td> <td>0°</td> <td>±2°</td> </tr> </table>	linear	0.X	±0.38				0.XX	±0.25		0.XXX	±0.13	angular	0°	±2°	chr	-	product family	-	rel level	Released
linear	0.X	±0.38																			
	0.XX	±0.25																			
	0.XXX	±0.13																			
angular	0°	±2°																			
		appr	Nickor Zuo	2017/08/11			dwg no	10081530													
		www.fci.com		cat. no.	-	Product - Customer Drw	sheet 2 of 4		rev	L											

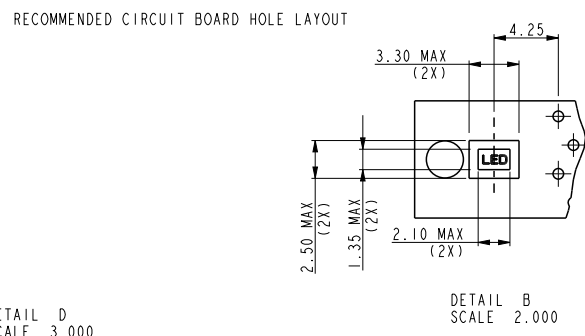
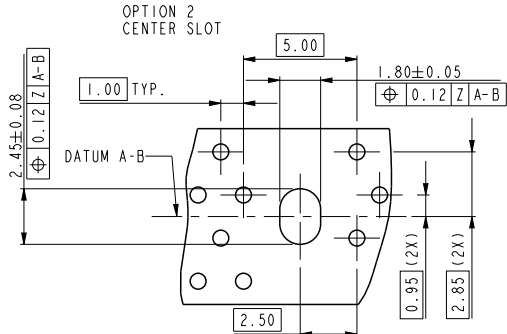
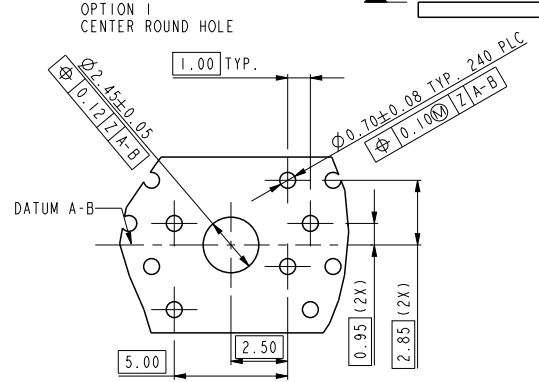
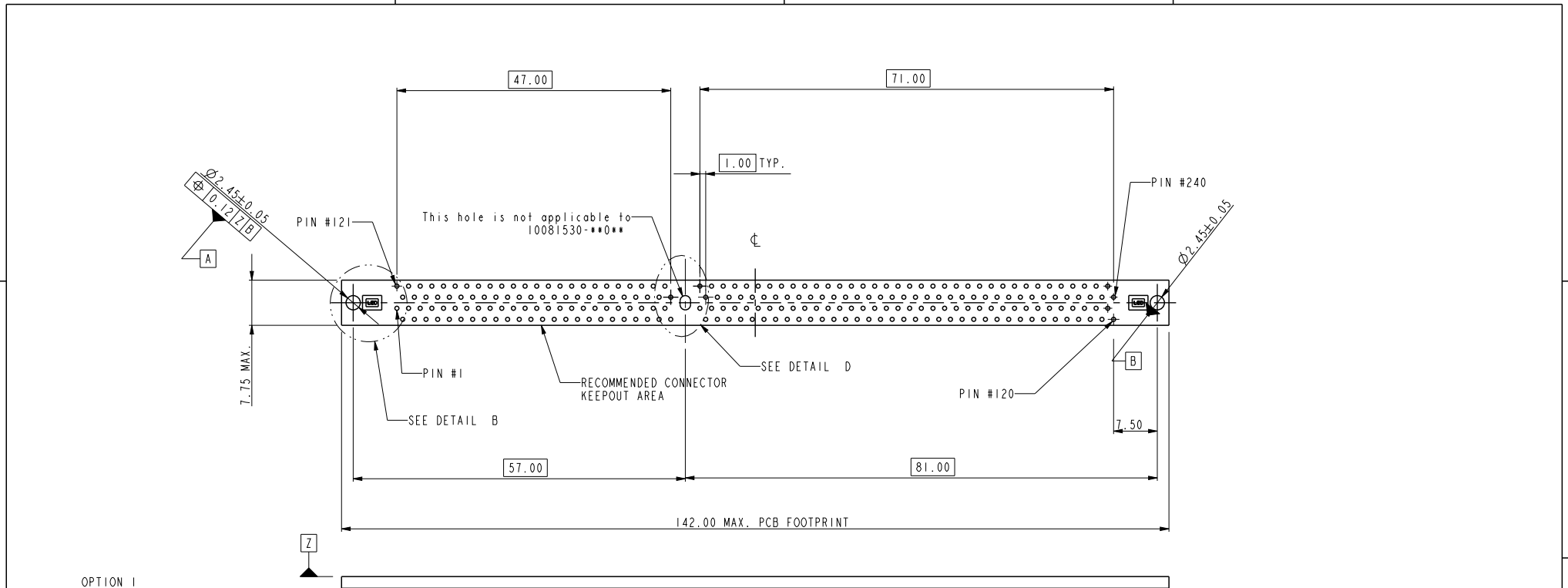

spec ref	*	dr	Rick Bian	2010/07/03	projection	mm	size	A4	scale	0.500
tolerance std	TOLERANCES UNLESS OTHERWISE SPECIFIED	eng	Jeny Ren	2017/08/07			ecn no		ELX-DG-27598-1	
		chr	-	-			rel level		Released	
surface		appr	Nickor Zuo	2017/08/11	product family		-		rev	
	linear				title		DDR3 R-DIMM CONNECTOR		dwg no	
					www.fci.com		-		10081530	
	angular				cat. no.		-		L	
					Product - Customer Drw		-		sheet 3 of 4	

10081530 - □ □ □ □

STYLE : MECHANICAL KEYING

- 1 : 1.5 VOLT. W/ CENTER KEY "XB"
- 2 : X.X VOLT. W/ LEFT KEY "XA"
- 3 : X.X VOLT. W/ RIGHT KEY "XC"
- 4 : 1.5 VOLT. W/ CENTER KEY "XB" (WITH THE SPECIAL PACKING)

CODE	METAL CLIP DIM "D"	TAIL LENGTH DIM "B"	METAL CLIP QTY AND LOCATION
11 Except -111*8ELF/-411*8ELF -111*8SLF/-411*8SLF	3.05	2.67	3 (BOTH ENDS AND CENTER)
22	3.56	3.18	
33	3.56	4.00	
10	3.05	2.67	
20	3.56	3.18	2 (BOTH ENDS)
30	3.56	4.00	
-111*8ELF/-411*8ELF -111*8SLF/-411*8SLF	3.45	2.67	3 (BOTH ENDS AND CENTER)

PLATING

CODE	CONTACT	SOLDERTAIL	UNDERPLATE	NOTE
2	15u" (0.38um) MIN. GOLD	100u" (2.54um) MIN. TIN/LEAD	50u" (1.27um) MIN. NICKEL OVERALL	
3	30u" (0.76um) MIN. GOLD			
4	GOLD FLASH			
5LF	20u" (0.508um) MIN. GOLD	100u" (2.54um) MIN. 100% TIN	90u" (2.29um)MIN NICKEL OVERALL	CONTACT NON LUBRICATED
7LF	15u" (0.38um) MIN. GOLD			
8LF	30u" (0.76um) MIN. GOLD			
9LF	3u" (0.07um) MIN. GOLD			
8SLF	30u" (0.76um) MIN. GOLD			
8ELF	30u" (0.76um) MIN. GXT		90u" (2.29um)MIN NICKEL OVERALL	CONTACT PAO LUBRICATED
7NLF	15u" (0.38um) MIN. GOLD			
8NLF	30u" (0.76um) MIN. GOLD		50u" (1.27um) MIN. NICKEL OVERALL	CONTACT NON LUBRICATED
9NLF	3u" (0.07um) MIN. GOLD			
7GLF	15u" (0.38um) MIN. GXT			50u" (1.27um) MIN. NICKEL OVERALL
8GLF	30u" (0.76um) MIN. GXT			

NOTES:

1. MATERIAL:
HOUSING: HIGH PERFORMANCE RESINS, GLASS FILLED UL94V-0 RATED.
EJECTOR: HIGH PERFORMANCE RESINS, GLASS FILLED UL94V-0 RATED.
TERMINAL: COPPER ALLOY.
METAL CLIP: COPPER ALLOY.
2. FCI LOGO TO BE APPROXIMATELY LOCATED AS SHOWN ON PRINT.
3. PRODUCT SPECIFICATION: GS-12-486.
4. PACKAGING SPECIFICATION: GS-14-899.
- ⑤. CARD THICKNESS APPLIES ACROSS TABS AND INCLUDES PLATING AND/OR METALIZATION.
- ⑥. LEADING EDGE OF CONTACT PADS SPECIFIED BY THE KEEP OUT ZONE SHALL BE FREE OF BURRS AND EXTERNAL TIE BARS. FOR OPTIMUM PERFORMANCE, THE TIE BAR IS TO BE ON AN INTERNAL LAYER SO THAT THE REMNANT CANNOT CAUSE CONTACT DAMAGE.
- ⑦. DATE CODE: DATE CODE MMDDYY IS ASSEMBLY DATE, L IS PRODUCTION LINE("D" DENOTES FCI DONGGUAN).
8. SOCKET IS COMPLIANT TO JEDEC SO-007 AND ACCEPTS JEDEC MODULE MO-269, VARIATIONS AA THRU FC.
9. THIS PRODUCT MEETS EUROPEAN UNION DIRECTIVES AND OTHER COUNTRY REGULATIONS AS DESCRIBED IN GS-22-008.
10. THE HOUSING WILL WITH STAND EXPOSURE TO 260°C PEAK TEMPERATURE FOR 10 SECONDS IN A WAVE SOLDER APPLICATION.
11. THE CLEAR LATCH CAN WITHSTAND MAX 174°C EXPOSURE TEMPERATURE.

COLOR OF HOUSING AND EJECTOR

- 0 : BLACK HOUSING + IVORY EJECTOR
- 1 : BLUE HOUSING + IVORY EJECTOR
- 2 : BLACK HOUSING + BLACK EJECTOR
- 3 : BLACK HOUSING + CLEAR EJECTOR
- 4 : BLUE HOUSING + CLEAR EJECTOR
- 5 : IVORY HOUSING + CLEAR EJECTOR
- 6 : BLACK HOUSING + BLUE(2945C) EJECTOR
- 7 : IVORY HOUSING + IVORY EJECTOR
- 8 : BLACK HOUSING + GREEN(375C) EJECTOR
- 9 : IVORY HOUSING + BLACK EJECTOR
- A : GREEN HOUSING + IVORY EJECTOR

spec ref	*	dr	Rick Bian	2010/07/03	projection	mm	size	A4	scale	0.500	
tolerance std	TOLERANCES UNLESS OTHERWISE SPECIFIED	eng	Jeny Ren	2017/08/07			ecn no	ELX-DG-27598-1			
		chr	-	-				rel level	Released		
		appr	Nickor Zuo	2017/08/11					product family	-	
surface	linear	0.X	±0.38		Amphenol FCI	DDR3 R-DIMM CONNECTOR	dwg no	10081530		rev	L
		0.XX	±0.25								
		0.XXX	±0.13								
	angular	0°	±2°		www.fci.com	cat. no.	-	Product - Customer Drw		sheet 4 of 4	

Компания «Океан Электроники» предлагает заключение долгосрочных отношений при поставках импортных электронных компонентов на взаимовыгодных условиях!

Наши преимущества:

- Поставка оригинальных импортных электронных компонентов напрямую с производств Америки, Европы и Азии, а так же с крупнейших складов мира;
- Широкая линейка поставок активных и пассивных импортных электронных компонентов (более 30 млн. наименований);
- Поставка сложных, дефицитных, либо снятых с производства позиций;
- Оперативные сроки поставки под заказ (от 5 рабочих дней);
- Экспресс доставка в любую точку России;
- Помощь Конструкторского Отдела и консультации квалифицированных инженеров;
- Техническая поддержка проекта, помощь в подборе аналогов, поставка прототипов;
- Поставка электронных компонентов под контролем ВП;
- Система менеджмента качества сертифицирована по Международному стандарту ISO 9001;
- При необходимости вся продукция военного и аэрокосмического назначения проходит испытания и сертификацию в лаборатории (по согласованию с заказчиком);
- Поставка специализированных компонентов военного и аэрокосмического уровня качества (Xilinx, Altera, Analog Devices, Intersil, Interpoint, Microsemi, Actel, Aeroflex, Peregrine, VPT, Syfer, Eurofarad, Texas Instruments, MS Kennedy, Miteq, Cobham, E2V, MA-COM, Hittite, Mini-Circuits, General Dynamics и др.);

Компания «Океан Электроники» является официальным дистрибьютором и эксклюзивным представителем в России одного из крупнейших производителей разъемов военного и аэрокосмического назначения «JONHON», а так же официальным дистрибьютором и эксклюзивным представителем в России производителя высокотехнологичных и надежных решений для передачи СВЧ сигналов «FORSTAR».



JONHON

«JONHON» (основан в 1970 г.)

Разъемы специального, военного и аэрокосмического назначения:

(Применяются в военной, авиационной, аэрокосмической, морской, железнодорожной, горно- и нефтедобывающей отраслях промышленности)

«FORSTAR» (основан в 1998 г.)

ВЧ соединители, коаксиальные кабели, кабельные сборки и микроволновые компоненты:

(Применяются в телекоммуникациях гражданского и специального назначения, в средствах связи, РЛС, а так же военной, авиационной и аэрокосмической отраслях промышленности).



Телефон: 8 (812) 309-75-97 (многоканальный)

Факс: 8 (812) 320-03-32

Электронная почта: ocean@oceanchips.ru

Web: <http://oceanchips.ru/>

Адрес: 198099, г. Санкт-Петербург, ул. Калинина, д. 2, корп. 4, лит. А