

General Description

The MIC2010 is a dual channel USB power switch designed to support the power distribution requirements for USB Wakeup from the ACPI S3 state. The MIC2010 will directly switch its two outputs between a 5V main supply and a 5V auxiliary supply normally provided in ATX style power supplies.

The MIC2010 will adjust its current-limit threshold according to the ACPI state it is in. In the normal active ACPI S0 state the current-limit is set at 500mA minimum per channel satisfying the USB continuous output current specification. In the S3 state the current-limit can be reduced to a value determined by an external resistor to minimize the current that is supplied by the auxiliary supply, thereby ensuring that voltage regulation is maintained even during fault conditions.

The MIC2010 provides make-before-break switching to ensure glitch-free transitions between the S3 and S0 states. Each channel is also thermally isolated from the other so that a fault in one channel does not effect the other. FAULT status output signals are also provided indicating overcurrent and thermal shutdown conditions.

The MIC2070 option latches the output off upon detecting an overcurrent condition lasting for more than 5ms minimum. The output can be reset by either toggling the EN inputs of the MIC2070-1/-2 or by removing the load. Latching the output off provides a circuit breaker mode of operation which reduces power consumption during fault conditions.

Features

- Compliant to USB power distribution specifications
- Two completely independent switches
- Integrated switching matrix supports ACPI S0/S3 state transitions without external FET circuits
- Make-before-break switching ensures glitch-free transitions
- No back-feed of auxiliary supply onto main supply during standby mode
- Bi-level current-limit preserves auxiliary supply voltage regulation in standby mode
- Thermally isolated channels
- Thermal shutdown protection
- Fault status outputs with filter prevents false assertions during hot-plug events
- Circuit breaker options with auto-reset (MIC2070)
- Undervoltage lockout
- UL File #179633

Applications

- Desktop PCs
- Notebook PCs
- Notebook docking stations
- LAN Servers
- PC motherboard

Typical Application

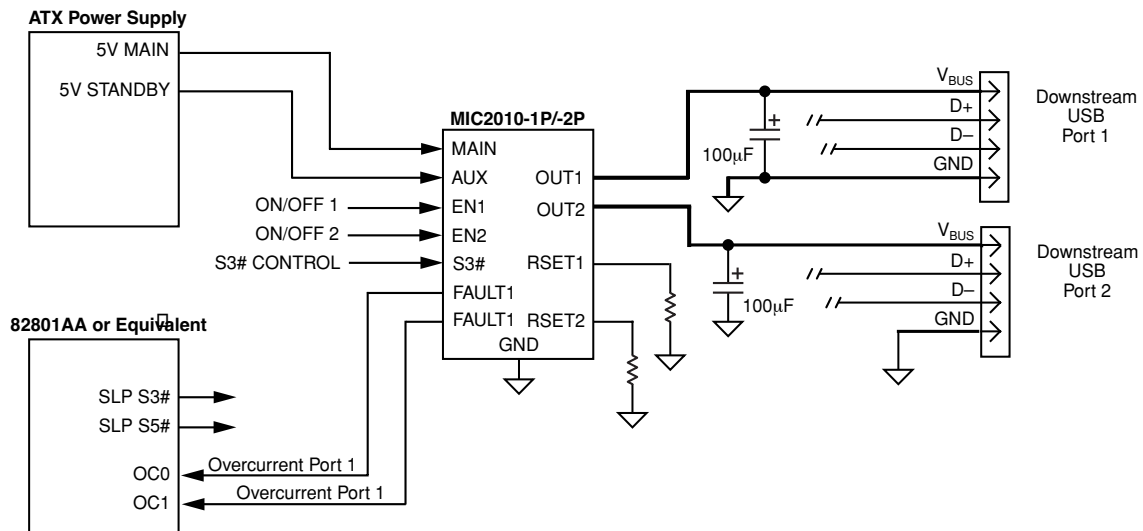

Figure 1. USB Wakeup From ACPI S3 System Diagram



UL Recognized Component

Ordering Information

Part Number		Enable	Circuit Breaker Function	Temperature Range	Package
Standard	Pb-Free				
MIC2010-1PCQS	MIC2010-1PZQS	Active High		0°C to +70°C	16-lead QSOP
MIC2010-2PCQS	MIC2010-1PZQS	Active Low		0°C to +70°C	16-lead QSOP
MIC2070-1PCQS	MIC2070-1PZQS	Active High	✓	0°C to +70°C	16-lead QSOP
MIC2070-2PCQS	MIC2070-2PZQS	Active Low	✓	0°C to +70°C	16-lead QSOP

Pin Configuration

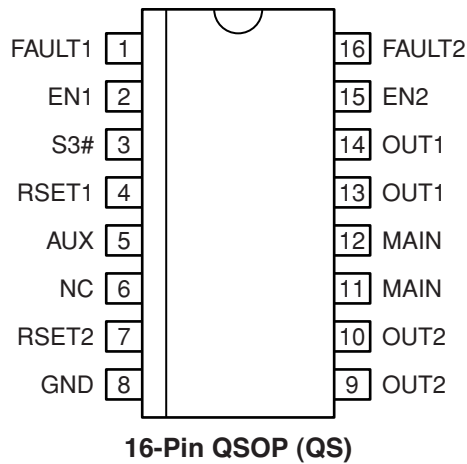

Pin Description

Pin Number	Pin Name	Pin Function
1	FAULT1	Fault Status (Output): Channel 1, active-low; weak pull-up to AUX. FAULT1 is asserted LOW when channel 1 is in a thermal shutdown state or overcurrent condition for more than 5ms. MIC2070 latches this output in its asserted state upon overcurrent condition. Toggling EN1 or removing the load will reset the circuit breaker latch, and deassert FAULT1.
2	EN1	Enable (Input): Channel 1, active-high (-1) or active-low (-2). Toggling this input also resets the latched output of the MIC2070.
3	S3#	Control (Input): When this input is high, the MAIN inputs are connected to OUT1 and OUT2 via 100m Ω , 500mA MOSFET switches. When this input is LOW, the AUX inputs are connected to OUT1 and OUT2 via 500m Ω MOSFET switches with a current-limit threshold specified by external resistors, RSET1 and RSET2.
4	RSET1	Current-Limit Set Resistor (Input): Channel 1. A resistor connected to this input sets the current-limit threshold in AUX mode (S3# asserted). The current-limit threshold is determined by approximately 18/RSET1.
5	AUX	Auxiliary 5V Supply (Input): Also used as power supply for internal circuitry.
6	NC	No Connection: This pin may be connected to other pins without restriction.
7	RSET2	Current-Limit Set Resistor (Input): Channel 2. A resistor connected to this input sets the current-limit threshold in AUX mode (S3# asserted). The current-limit threshold is determined by approximately 18/RSET2.
8	GND	Ground
9, 10	OUT2	Channel 2 (Output): Both pins must be connected together externally.
11, 12	MAIN	5V Main Supply (Input): All MAIN inputs must be connected together externally.
13, 14	OUT1	Channel 1 (Output): Both pins must be connected together externally.
15	EN2	Enable (Input): Channel 2, active-high (-1) or active-low (-2). Toggling this input also resets the latched output for the MIC2070.
16	FAULT2	Fault Status (Output): Channel 2, active-low; weak pull-up to AUX. FAULT2 is asserted LOW when channel 2 is in a thermal shutdown state or overcurrent condition for more than 5ms. MIC2070 latches this output in its asserted state upon overcurrent condition. Toggling EN2 or removing load will reset the circuit breaker latch, and deassert FAULT2.

Absolute Maximum Ratings (1, 4)

Supply Voltage (V_{IN})	-0.3V to 6V
FAULT#, OUT1, OUT2 Output Pins	-0.3V to 6V
FAULT1, FAULT2, Output Current	25mA
ESD Rating ⁽³⁾	2kV

Operating Ratings⁽²⁾

Supply Voltage (V_{MAIN} , V_{AUX})	+4.5V to +5.5V
Continuous Output Current (AUX Mode) ..	50mA to 300mA
Ambient Temperature (T_A)	-0°C to +70°C
Junction Temperature (T_J)	Internally Limited
Package Thermal Resistance	
QSOP(θ_{JA})	163°C/W

Electrical Characteristics

$V_{MAIN} = 5V$; $AUX = 5V$; $R_{SET} = 125\Omega$, $T_A = 25^\circ C$.

Symbol	Parameter	Condition	Min	Typ	Max	Units
V_{MAIN}	MAIN Supply Voltage		4.5	5.0	5.5	V
I_{MAIN}	MAIN Supply Current ⁽⁵⁾	S3# = 1, both switches ON, no load S3# = 1, both switches OFF, no load		16	22 5	μA μA
I_{LEAK}	MAIN Reverse Leakage Current ⁽⁵⁾	S3# = 0, both switches ON, $V_{MAIN} = 0V$	-10		+10	μA
V_{AUX}	AUX Supply Voltage		4.5	5.0	5.5	V
I_{AUX}	AUX Supply Current ⁽⁵⁾	S3# = 0; No load, both switches ON S3# = 0; No load, both switches OFF		.6	1 5	mA μA
$V_{UV/AUX}$	AUX Undervoltage Lockout Threshold	V_{AUX} increasing V_{AUX} decreasing	3.5 3.3	3.7 3.5	4.0 3.8	V V
V_{HYS}	AUX Undervoltage Lockout Hysteresis			200		mV
R_{DSMAIN}	MAIN On-Resistance, Each Output	S3# = 1, $I_{OUT} = 500mA$		100	140	m Ω
R_{DSAUX}	AUX On-Resistance, Each Output	S3# = 0, $I_{OUT} = 100mA$		500	700	m Ω
I_{LIMIT}	MAIN Current-Limit Threshold,	S3# = 1, $V_{OUT} = 4.0V$, ramped load	0.5		1.25	A
	MAIN Short-Circuit Current-Limit	$V_{OUT} = 0V$	0.5		1.25	A
	Current-Limit Factor (AUX Supply) ⁽⁶⁾	S3# = 0, $I_{OUT} = 50mA$ to 300mA $V_{OUT} = 4V$	14.4	18	21.6	A • Ω
V_{TH}	S3#, EN1, EN2 Input Threshold Voltage	High-to-Low transition	.8	1.5		V
		Low-to-High transition		1.7	2.0	V
I_{IN}	S3#, EN1, EN2 Input Current	$V_{S3/EN} = 5V, 0V$	-1		1	μA
V_{HYS}	EN1, EN2 and S3# Input Hysteresis			200		mV
I_{OFF}	OUT1, 2 Leakage Current	Outputs are off, $V_{OUT} = 0$	-10		10	μA
	Pull-Up Current During Latched Output State (MIC2070-x only)	Outputs latched off	TBD	1	TBD	mA
$V_{TH LATCH}$	Latch Reset Threshold	V_{OUT} rising		1.95		V
	Minimum Output Slew Rate to Reset Latch (MIC2070-x only) ⁽⁷⁾	Output rising		.4		V/s
	Overtemperature Threshold	T_J increasing, single channel		140		$^\circ C$
		T_J decreasing, single channel		120		$^\circ C$
		T_J increasing, both channels		160		$^\circ C$
		T_J decreasing, both channels		125		$^\circ C$
V_{OL}	FAULT1, 2 Output Low Voltage	$I_{FAULT} = 5mA$			0.2	V
	FAULT1, 2 Output Off Current (Not Applicable for 'P' versions)	$V_{FAULT} = 5V$		0.2	10	μA

Symbol	Parameter	Condition	Min	Typ	Max	Units
V_{OH}	FAULT1, 2 Output High Voltage (MIC2010-1P, 2P), (MIC2070-1P, 2P)	$I_{FAULT} = -20\mu A$	4			V
T_H	MAIN to S3# Hold Time, Note 7	Figure 5	5			ms
T_S	MAIN to S3# Set-up Time, Note 7	Figure 5	0			ms
t_{DLY}	FAULT Delay Filter Response Time (Overcurrent only), Note 8	Output shorted to ground, Figure 4	5	10	20	ms
t_{OC}	Overcurrent Response Time	Output shorted to ground, Figure 4 MAIN output AUX output		2 2		μs μs
$t_{ON(MAIN)}$	MAIN Output Turn-On Time	$R_L = 10\Omega$, $C_L = 1\mu F$, Figure 3		2		ms
$t_{OFF(MAIN)}$	MAIN Output Turn-Off Time	$R_L = 10\Omega$, $C_L = 1\mu F$, Figure 3		35		μs
$t_r(MAIN)$	MAIN Output Rise Time	$R_L = 10\Omega$, $C_L = 1\mu F$, Figure 3		2		ms
$t_f(MAIN)$	MAIN Output Fall Time	$R_L = 10\Omega$, $C_L = 1\mu F$, Figure 3		32		μs
$t_{ON(AUX)}$	AUX Output Turn-On Time	$R_L = 50\Omega$, $C_L = 1\mu F$, Figure 3		0.6		ms
$t_{OFF(AUX)}$	AUX Output Turn-Off Time	$R_L = 50\Omega$, $C_L = 1\mu F$, Figure 3		120		μs
$t_r(AUX)$	AUX Output Rise Time	$R_L = 50\Omega$, $C_L = 1\mu F$, Figure 3		0.5		ms
$t_f(AUX)$	AUX Output Fall Time	$R_L = 50\Omega$, $C_L = 1\mu F$, Figure 3		115		μs
t_{XMA}	MAIN to AUX Cross Conduction Time, Note 9	S3# transition to 0		5	7.5	ms
t_{XAM}	AUX to MAIN Cross Conduction Time, Note 9	S3# transition to 1		5	7.5	ms

Notes:

1. Exceeding the absolute maximum rating may damage the device.
2. The device is not guaranteed to function outside its operating rating.
3. Devices are ESD sensitive. Handling precautions recommended. Human body model, 1.5k in series with 100pF.
4. All voltages are referenced to ground.
5. For MIC2070-1(P) OFF occurs when $V_{EN} < 0.8V$ and ON occurs when $V_{EN} > 2.4V$. For MIC2070-2(P) OFF occurs when $V_{EN} > 2.4V$ and ON occurs when $V_{EN} < 0.8V$.
6. Current-limit threshold is defined by the current-limit factor divided by R_{SET} .
7. Guaranteed by design. Not production tested.
8. Assumes only one channel in current-limit. Delay circuitry is shared among channels so it is possible for t_{DLY} to be 40ms max if one channel enters current-limit as the other is about to time-out.
9. Cross conduction time is the duration in which both MAIN and AUX internal switches are on subsequent to S3# transitioning.

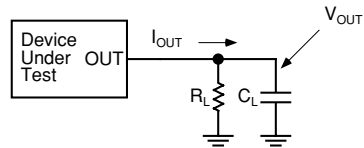
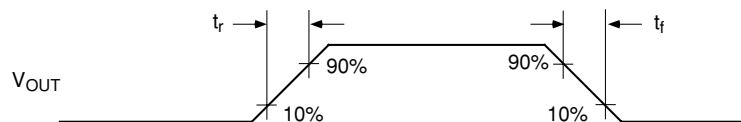
Test Circuit**Timing Diagram**

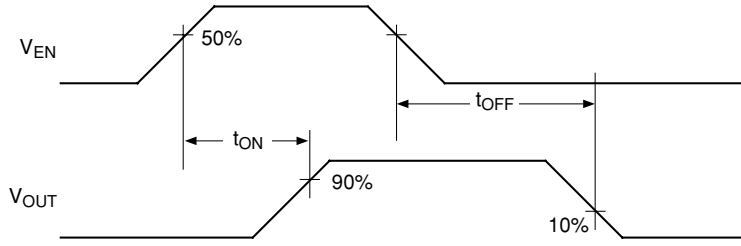

Figure 2. MIC2010/70-1

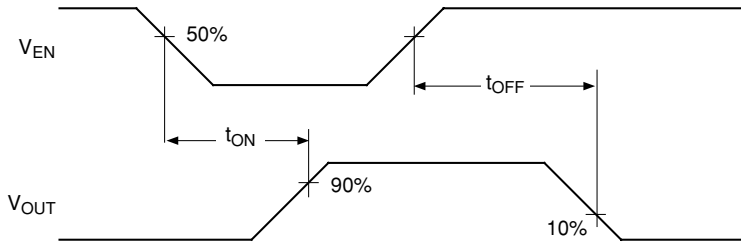

Figure 3. MIC2010/70-2

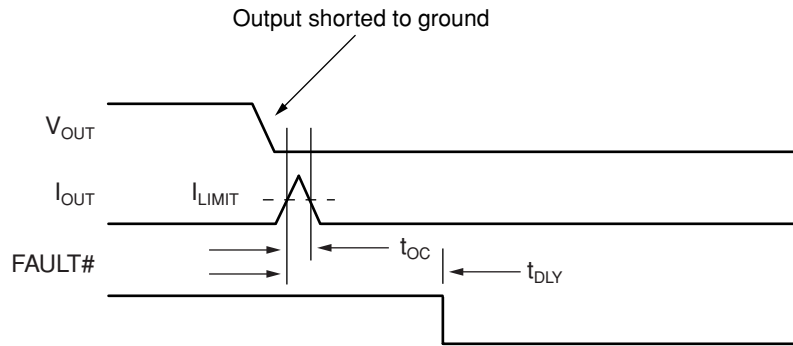

Figure 4. Overcurrent Response Timing

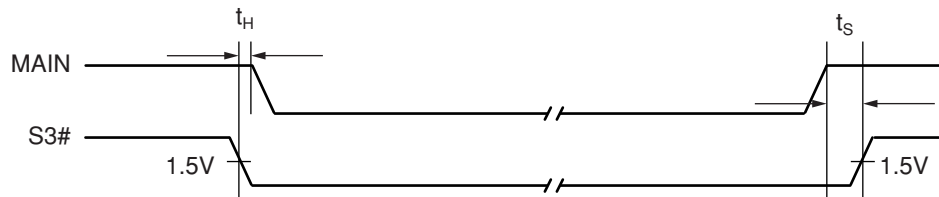
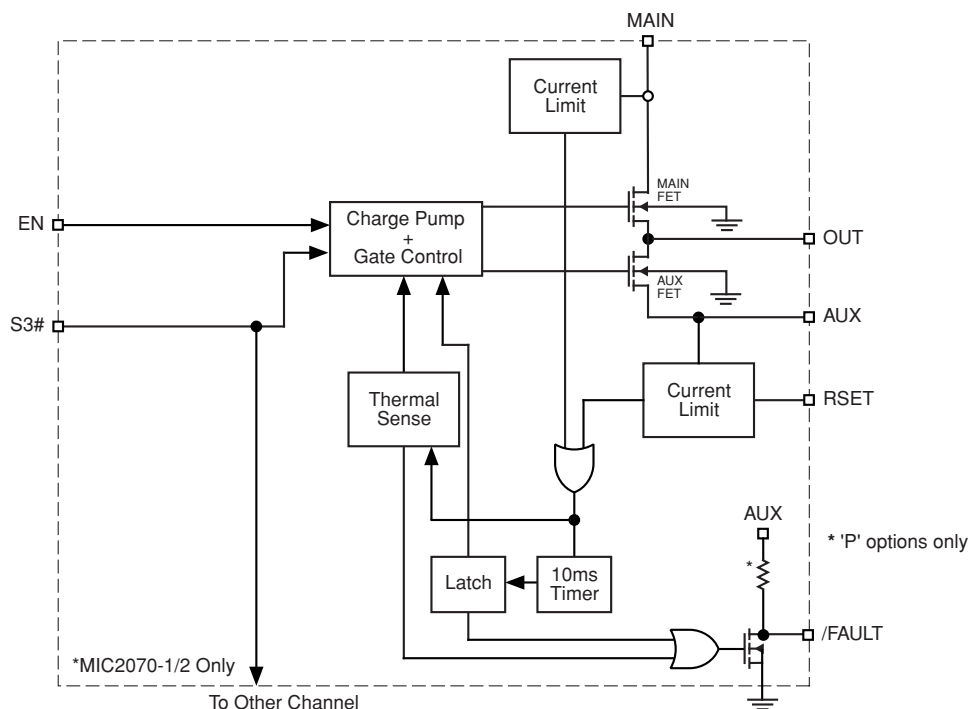

Figure 5. MAIN to S3# Timing

Functional Diagram



Functional Description

The MIC2010/2070 are designed to support the power distribution requirements for USB wakeup from the ACPI S3 state. It integrates two independent channels under control of input S3#. When S3# is asserted LOW (ACPI S3 state) the MIC2010/2070 will switch a 500mΩ MOSFET switch from the AUX input to each of its two outputs. In addition the current-limit threshold will be set to a value specified by a resistor connected to the RSET inputs. Conversely when the S3# input is HIGH the MIC2010/2070 will switch a 100mΩ MOSFET switch from the MAIN inputs to each of its two outputs. The current-limit threshold is preset to 500mA in this state. The lower current limit during the ACPI S3 state helps to ensure that the standby supply maintains regulation even during fault conditions.

Thermal Shutdown

Thermal shutdown is employed to protect the device from damage should the die temperature exceed safe margins due mainly to short circuit faults. Thermal shutdown shuts off the output MOSFET and asserts the FAULT output if the die temperature reaches 140°C and the overheated channel is in current limit. The other channel is not affected. If however, the die temperature exceeds 160°C, both channels will be shut off even if neither channel is in current limit.

Power Dissipation

The device's junction temperature depends on several factors such as the load, PCB layout, ambient temperature and package type. The power dissipated in each channel is

$P_D = R_{DS(on)} \times I_{OUT}^2$ where $R_{DS(on)}$ is the on-resistance of the internal MOSFETs and I_{OUT} is the continuous output current.

Total power dissipation of the device will be the summation of P_D for both channels. To relate this to junction temperature, the following equation can be used:

$$T_J = P_D \times \theta_{JA} + T_A$$

where:

T_J = junction temperature

T_A = ambient temperature

θ_{JA} = is the thermal resistance of the package

Current Sensing and Limiting

The current-limit threshold of each channel is preset internally at 500mA when S3# is deasserted. When S3# is asserted the current-limit threshold is specified by a resistor connected to the RSET input. The value of the current-limit threshold is determined by the equation $18/R_{SET}$ ohms where R_{SET} is the resistance connected between the RSET pin and ground. The current-limit threshold should be set at 1.2X of the applications continuous output current requirement.

When an overcurrent condition lasts longer than t_{DLY} the MIC2070 will activate an internal circuit breaker that will latch the output off and assert FAULT. The output will remain off until either the load is removed or EN is toggled. When the MIC2070 enters a latched output condition a 1mA pull-up current source is activated. This provides a way to automatically reset the output once the load is removed without the need to toggle the enable input. Please refer to Figure 7 for timing details.

The MIC2010 will automatically reset its output when the die temperature cools down to 120°C. The MIC2010 output and FAULT signal will continue to cycle on and off until the device is disabled or the fault is removed. Figure 6 depicts typical timing. Depending on PCB layout, package, ambient temperature, etc., it may take several hundred milliseconds from the incidence of the fault to the output MOSFET being shut

off. This time duration will be shortest in the case of a dead short on the output.

Fault Status Output

The FAULT signal is an active-low output with a weak pull-up. FAULT is asserted when either an overcurrent or thermal shutdown condition occurs. In the case of an overcurrent condition, FAULT will be asserted only after the flag response delay time, t_{DLY} , has elapsed. This ensures that FAULT is asserted only upon valid overcurrent conditions and that erroneous error reporting is eliminated. The FAULT response delay time t_{DLY} is typically 10ms. Since the delay timer is shared between both channels it is possible for t_{DLY} to be

extended by an amount equal to the difference between the occurrence of the over-current event in both channels.

Undervoltage Lockout

Undervoltage lockout (UVLO) prevents the output MOSFET from turning on until the AUX input exceeds approximately 3.5V. UVLO ensures that the output MOSFETs remain off to prevent high transient inrush current due to stray or bulk load capacitance. This helps to ensure that the power supply voltage regulation is preserved and also prevents possible damage to sensitive components.

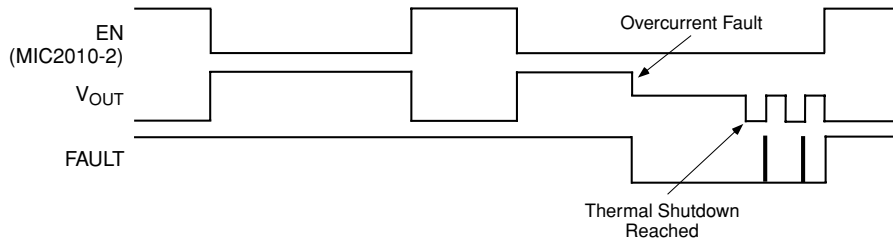
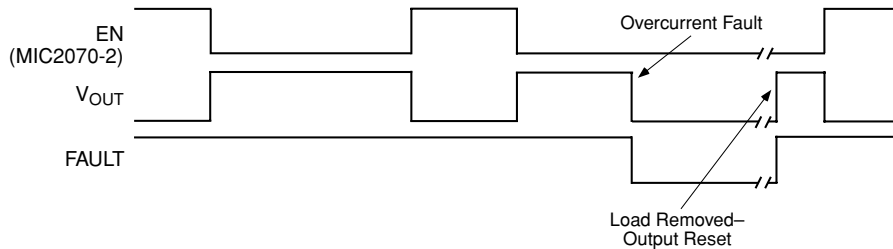

Figure 6. MIC2010 System Timing



**Figure 7. MIC2070 System Timing—
Output Resets When Load is Removed**

Functional Characteristics

AUX Start-up by UVLO

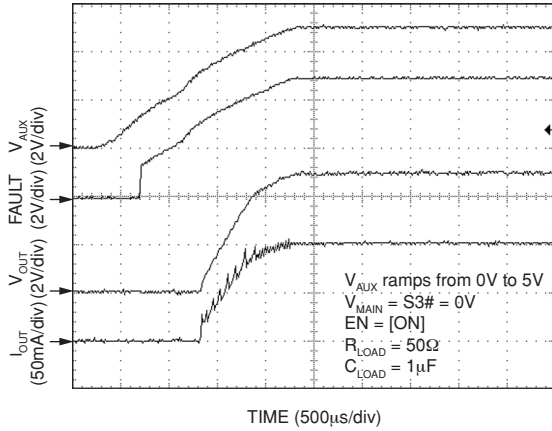

AUX Shutdown by UVLO

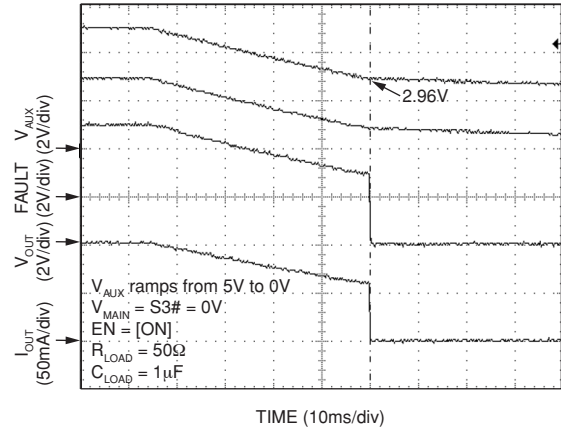

Main Start-up by UVLO

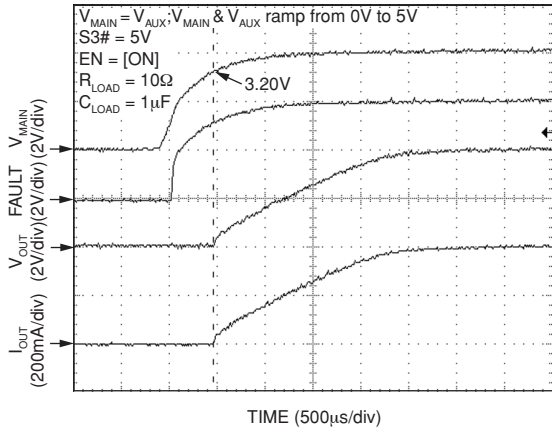

Main Shut-down by UVLO

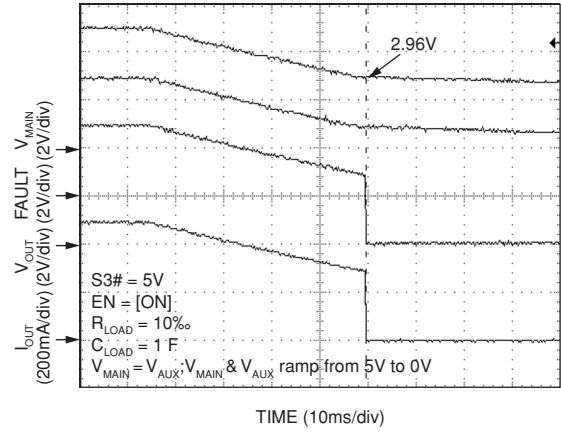

Main Turn-On Response

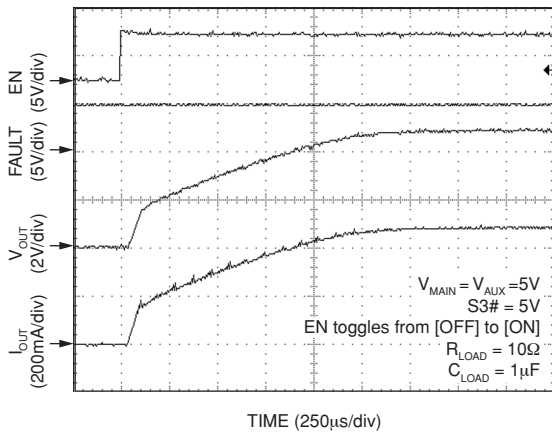

Main Turn-Off Response

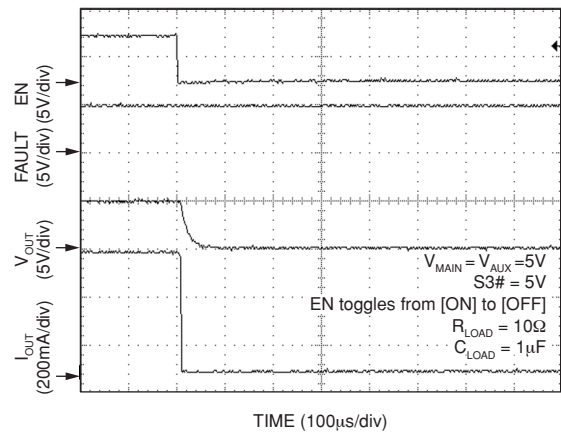

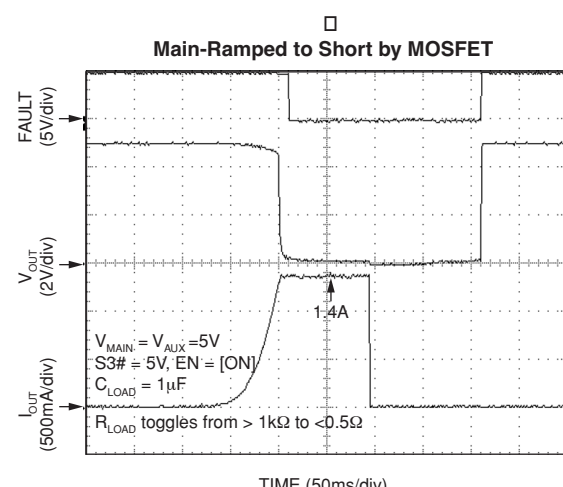
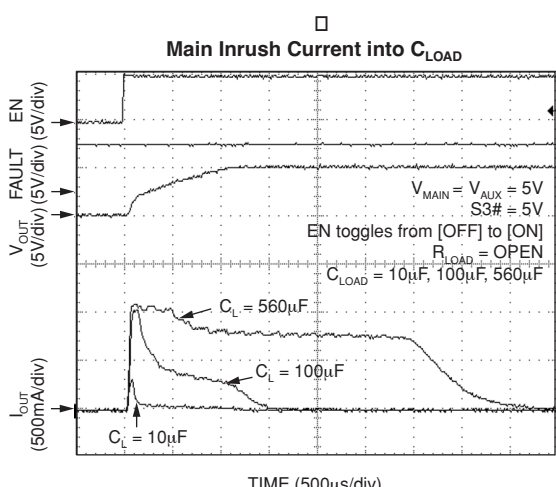
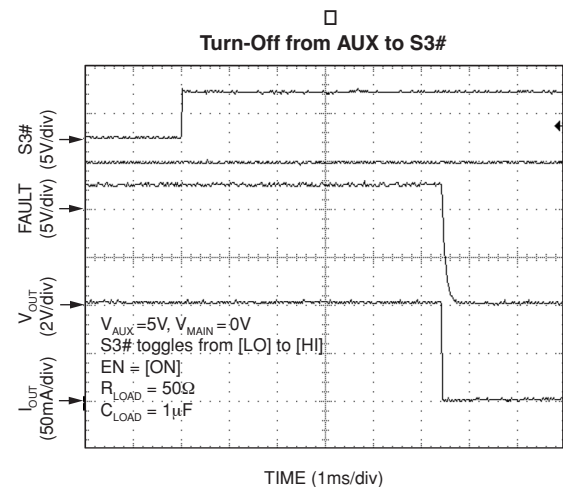
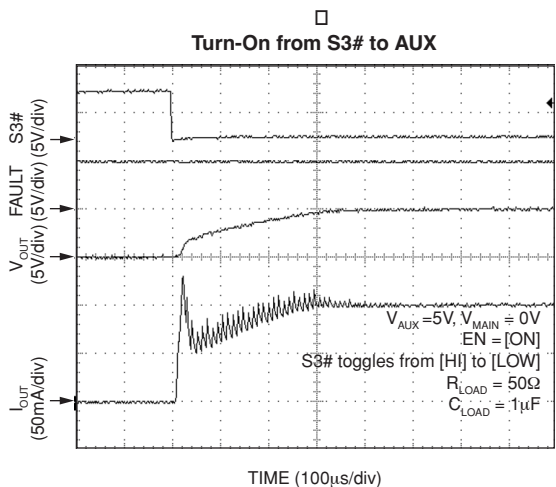
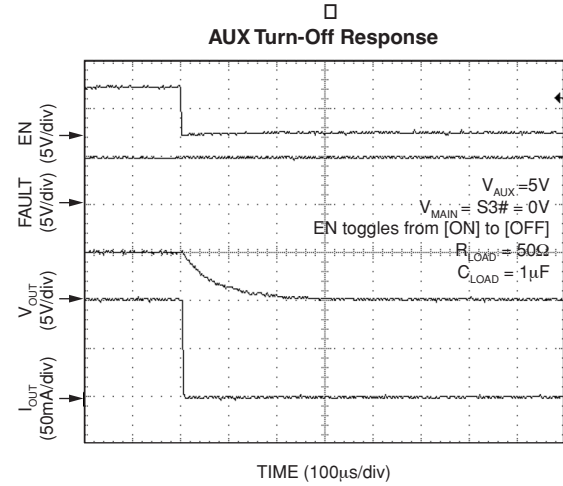
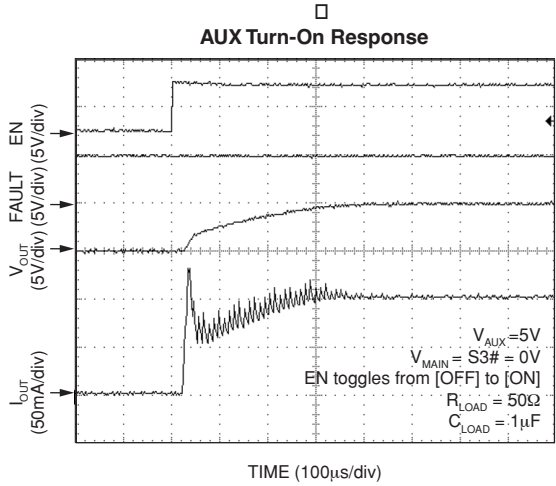

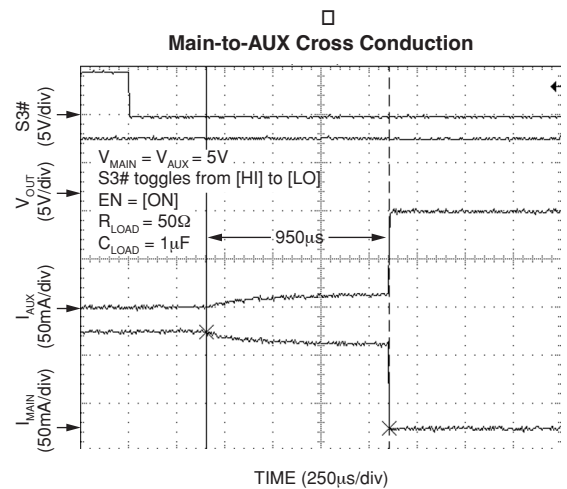
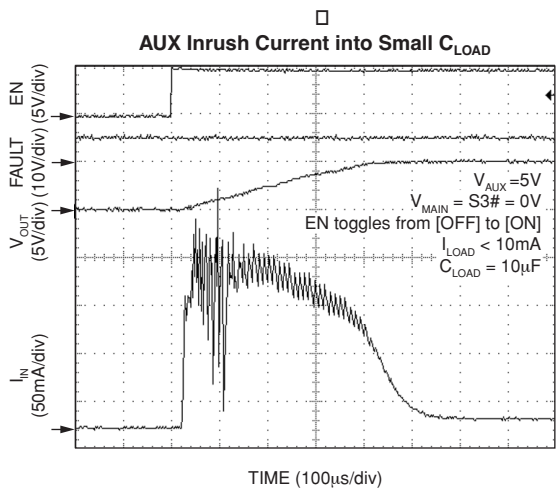
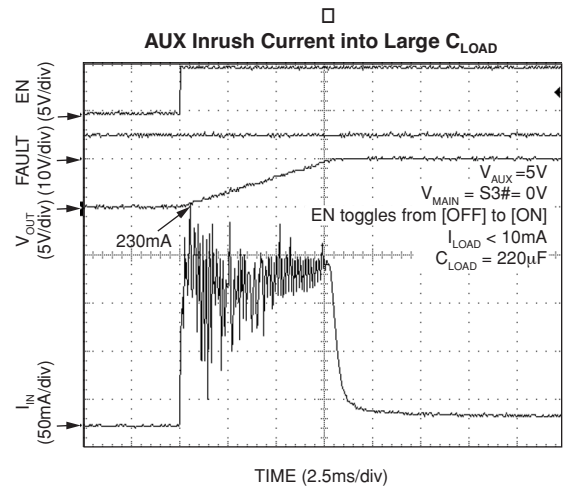
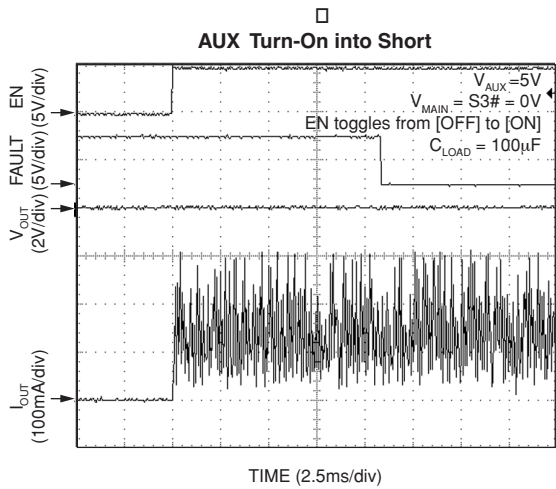
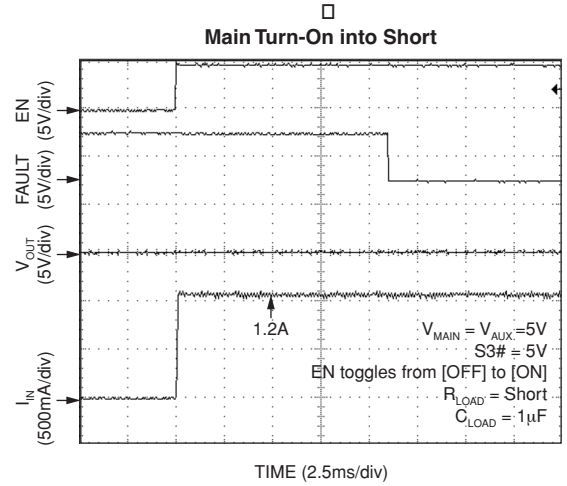
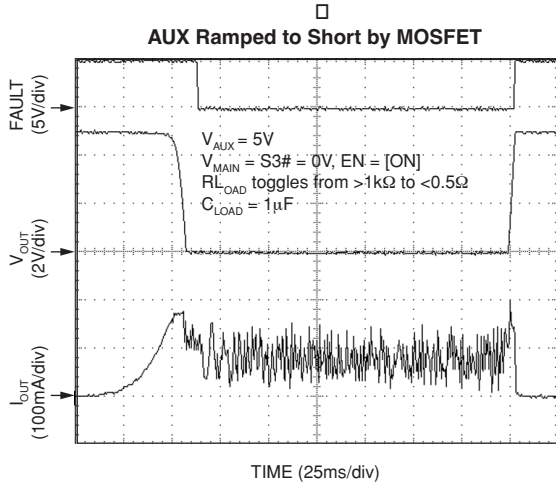

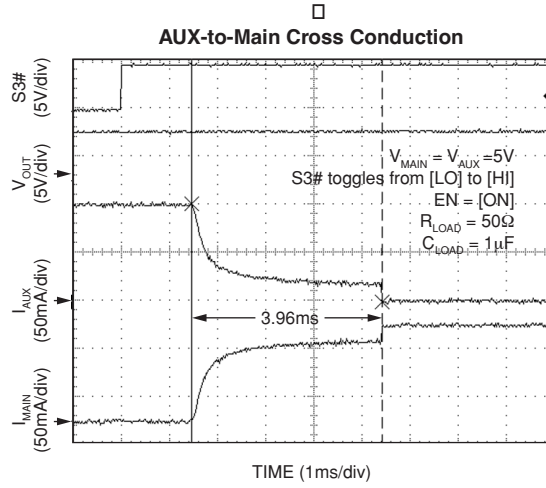

Package Information

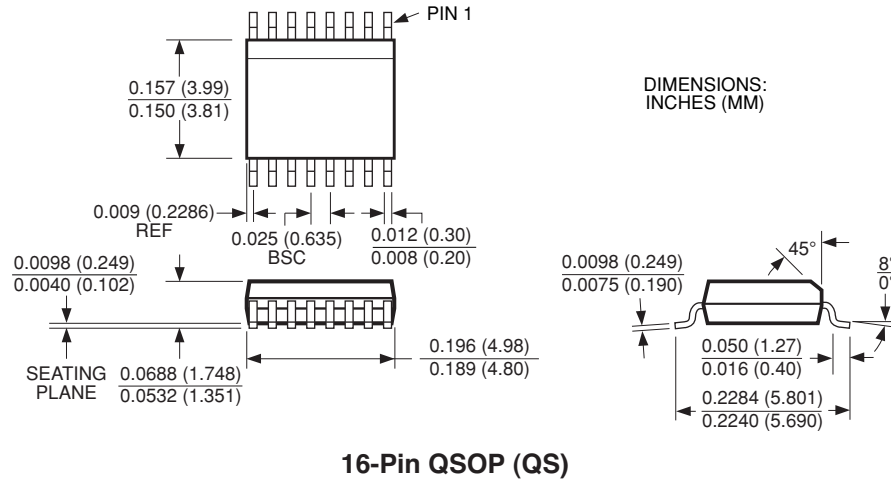

MICREL, INC. 2180 FORTUNE DRIVE SAN JOSE, CA 95131 USA

TEL + 1 (408) 944-0800 FAX + 1 (408) 474-1000 WEB <http://www.micrel.com>

The information furnished by Micrel in this datasheet is believed to be accurate and reliable. However, no responsibility is assumed by Micrel for its use. Micrel reserves the right to change circuitry and specifications at any time without notification to the customer.

Micrel Products are not designed or authorized for use as components in life support appliances, devices or systems where malfunction of a product can reasonably be expected to result in personal injury. Life support devices or systems are devices or systems that (a) are intended for surgical implant into the body or (b) support or sustain life, and whose failure to perform can be reasonably expected to result in a significant injury to the user. A Purchaser's use or sale of Micrel Products for use in life support appliances, devices or systems is at Purchaser's own risk and Purchaser agrees to fully indemnify Micrel for any damages resulting from such use or sale.

© 2005 Micrel, Incorporated.

Компания «Океан Электроники» предлагает заключение долгосрочных отношений при поставках импортных электронных компонентов на взаимовыгодных условиях!

Наши преимущества:

- Поставка оригинальных импортных электронных компонентов напрямую с производств Америки, Европы и Азии, а так же с крупнейших складов мира;
- Широкая линейка поставок активных и пассивных импортных электронных компонентов (более 30 млн. наименований);
- Поставка сложных, дефицитных, либо снятых с производства позиций;
- Оперативные сроки поставки под заказ (от 5 рабочих дней);
- Экспресс доставка в любую точку России;
- Помощь Конструкторского Отдела и консультации квалифицированных инженеров;
- Техническая поддержка проекта, помощь в подборе аналогов, поставка прототипов;
- Поставка электронных компонентов под контролем ВП;
- Система менеджмента качества сертифицирована по Международному стандарту ISO 9001;
- При необходимости вся продукция военного и аэрокосмического назначения проходит испытания и сертификацию в лаборатории (по согласованию с заказчиком);
- Поставка специализированных компонентов военного и аэрокосмического уровня качества (Xilinx, Altera, Analog Devices, Intersil, Interpoint, Microsemi, Actel, Aeroflex, Peregrine, VPT, Syfer, Eurofarad, Texas Instruments, MS Kennedy, Miteq, Cobham, E2V, MA-COM, Hittite, Mini-Circuits, General Dynamics и др.);

Компания «Океан Электроники» является официальным дистрибьютором и эксклюзивным представителем в России одного из крупнейших производителей разъемов военного и аэрокосмического назначения «JONHON», а так же официальным дистрибьютором и эксклюзивным представителем в России производителя высокотехнологичных и надежных решений для передачи СВЧ сигналов «FORSTAR».



JONHON

«JONHON» (основан в 1970 г.)

Разъемы специального, военного и аэрокосмического назначения:

(Применяются в военной, авиационной, аэрокосмической, морской, железнодорожной, горно- и нефтедобывающей отраслях промышленности)

«FORSTAR» (основан в 1998 г.)

ВЧ соединители, коаксиальные кабели, кабельные сборки и микроволновые компоненты:

(Применяются в телекоммуникациях гражданского и специального назначения, в средствах связи, РЛС, а так же военной, авиационной и аэрокосмической отраслях промышленности).



Телефон: 8 (812) 309-75-97 (многоканальный)

Факс: 8 (812) 320-03-32

Электронная почта: ocean@oceanchips.ru

Web: <http://oceanchips.ru/>

Адрес: 198099, г. Санкт-Петербург, ул. Калинина, д. 2, корп. 4, лит. А