



OX-502

### Features

- 6-Pin SMD package
- Fast warm-up
- Frequency Range, 10 MHz to 40 MHz
- Standard freq: 10, 12.8, 20, 24.576, 25, 30.72 MHz
- High Reliability (based on fully intergrated Design)
- Low Power

### Applications

- Base stations 5G & 4 G)
- Test equipment
- Small Cell
- Military communication equipment
- Stratum 3
- SyncE; 1588

## Performance Specifications

| Frequency Stabilities <sup>1</sup> 10 to 40 MHz          |      |         |      |         |  |                      |
|--|------|---------|------|---------|--|----------------------|
| Parameter  | Min  | Typical | Max  | Units   | Condition  | Options <sup>5</sup> |
| vs. operating temperature range<br>(referenced to +25°C) | -20  |         | +20  | ppb     | -40 to +85°C   |                      |
|  | -10  |         | +10  | ppb     | -40 to +85°C   |                      |
|  | -20  |         | +20  | ppb     | -40 to +95°C   |                      |
| slope  | -2   |         | +2   | ppb/°C  | @ Temp stab. +-10ppb   |                      |
| Initial tolerance  | -0.5 |         | +0.5 | ppm     | at time of shipment, nominal EFC   |                      |
| vs. supply voltage change                                | -10  |         | +10  | ppb     | V <sub>c</sub> ±5% static  |                      |
| vs. load change  | -10  |         | +10  | ppb     | Load ±5% static  |                      |
| vs. aging / day  | -5   | ±2      | +5   | ppb     | after 30 days of operation   |                      |
| vs. aging / year   | 500  |         | +500 | ppb     | after 30 days of operation   |                      |
| vs. aging / 10 years                                     | -3   |         | 3    | ppm     | after 30 days of operation   |                      |
| Holdover drift   |      |         | 5    | ppb     | over 24 hours, constant temperature (<±1°C) ;<br>after 30 days continous operation   |                      |
| Start up time  |      |         | 200  | msec    |  |                      |
| Warm-up time   |      |         | 3    | minutes | to ±20ppb of final frequency (1 hour reading)<br>@ +25°C   |                      |
| Loop bandwidth for wander<br>generation compliance       | 3    |         |      | mHz     | MTIE compliant with GR-1244 Fig 5-5<br>TDEV compliant with GR- 1244 Fig 5-4 ;<br>measurement setup: oscillator stabilized 24<br>hours at Constant Temperature (±1°C, still<br>air), data collected over 100,000 seconds at 1<br>second intervals (-3dB cutoff, 1st order high<br>pass loop filter) |                      |

## Performance Specifications

| Supply Voltage (Vs)        |                            |         |       |        |                            |         |
|----------------------------|----------------------------|---------|-------|--------|----------------------------|---------|
| Parameter                  | Min                        | Typical | Max   | Units  | Condition                  |         |
| Supply voltage (standard)  | 3.135                      | 3.3     | 3.465 | VDC    |                            |         |
| Power consumption          |                            | 1.3     | 1.5   | Watts  | during warm-up             |         |
|                            |                            | 0.4     | 0.5   | Watts  | steady state @ +25°C       |         |
| RF Output                  |                            |         |       |        |                            |         |
| Signal [standard]          | LVHCMOS                    |         |       |        |                            |         |
| Load                       |                            | 15      |       | pF     |                            |         |
| Signal Level (Vol)         |                            |         | 0.4   | VDC    | with Vs=3.3V and 15pF Load |         |
| Signal Level (Voh)         | 2.97                       | 3.3     |       | VDC    | with Vs=3.3V and 15pF Load |         |
| Duty Cycle                 | 45                         |         | 55    | %      | @ (Voh-Vol)/2              |         |
| Ron                        |                            | 26.5    |       | Ω      |                            |         |
| Roff                       |                            | 22      |       | Ω      |                            |         |
| Frequency Tuning (EFC)     |                            |         |       |        |                            |         |
| Tuning Range               | Fixed OCXO; No adjust      |         |       |        | Opti-<br>on <sup>5</sup>   |         |
| Tuning Range               | ±3                         |         | ±8    | ppb    |                            |         |
| Linearity                  | 10%                        |         |       |        |                            |         |
| Tuning Slope               | Positive                   |         |       |        |                            |         |
| Control Voltage Range      | 0.0                        | 1.4     | 2.8   | VDC    |                            |         |
| Additional Parameters      |                            |         |       |        |                            |         |
| Phase Noise <sup>3</sup>   |                            | -99     | -90   | dBc/Hz | 10 Hz                      | @ 20MHz |
|                            |                            | -125    | -120  | dBc/Hz | 100 Hz                     |         |
|                            |                            | -145    | -140  | dBc/Hz | 1 kHz                      |         |
|                            |                            | -155    | -150  | dBc/Hz | 10 kHz                     |         |
|                            |                            | -160    | -155  | dBc/Hz | 100kHz                     |         |
| Weight                     |                            |         | 1.0   | g      |                            |         |
| Processing & Packing       | Handling & Processing Note |         |       |        |                            |         |
| Absolute Maximum Ratings   |                            |         |       |        |                            |         |
| Supply voltage (Vs)        |                            |         | 3.8   | V      | with Vs=3.3 VDC            |         |
| Output Load                |                            |         | 50    | pF     |                            |         |
| Operable Temperature Range | -40                        |         | +95   | °C     |                            |         |
| Storage Temperature Range  | -40                        |         | +125  | °C     |                            |         |

## Outline Drawing / Enclosure

G367

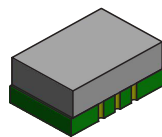
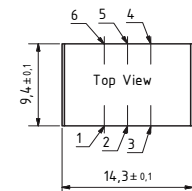
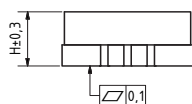
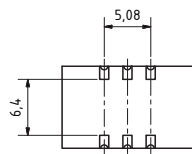

land pattern  
recommendation

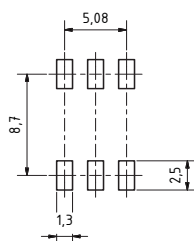

OX-502

|            |                |
|------------|----------------|
| Height "H" | cover material |
| 6.2        | plastic        |

Pin Connections

|   |                                     |
|---|-------------------------------------|
| 1 | I.C (Do not connect) / EFC (option) |
| 2 | N.C                                 |
| 3 | Ground (Case)                       |
| 4 | RF Output                           |
| 5 | N.C                                 |
| 6 | Supply Voltage Input                |

Dimensions in mm

# Standard Shipping Method (OX-502)

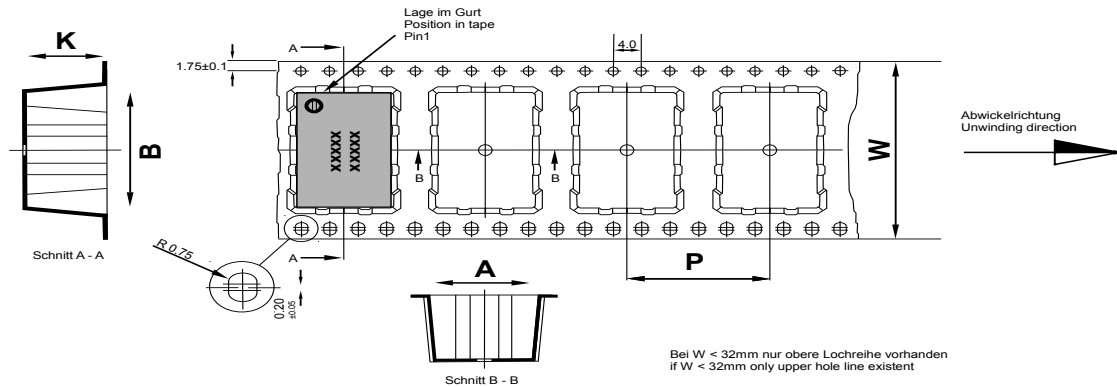

|  |  |
|--|--|
| Maßangaben in mm:<br>A, B und K Maße von Bauelement abhängig<br>Fertigungstoleranzen entsprechen der DIN IEC 286-3 | Dimension in mm:<br>A, B und K are dependent upon component dimensions<br>production tolerance complying DIN IEC 286-3 |
|--|--|

All dimensions in millimeters unless otherwise stated

| Enclosure Type  | Tape Width W (mm) | Quantity per meter | Quantity per reel | Dimension P |
|-----------------|-------------------|--------------------|-------------------|-------------|
| OX-502 (6.2 mm) | 24                | 83.3               | 400               | 12          |

## Reflow Profile

TP: max 250°C (@ solder joint, customer board level)  
 Tp: max: 10...40 sec

Additional Information:  
 This SMD oscillator has been designed for pick and place reflow soldering

SMD oscillators must be on the top side of the PCB during the reflow process.

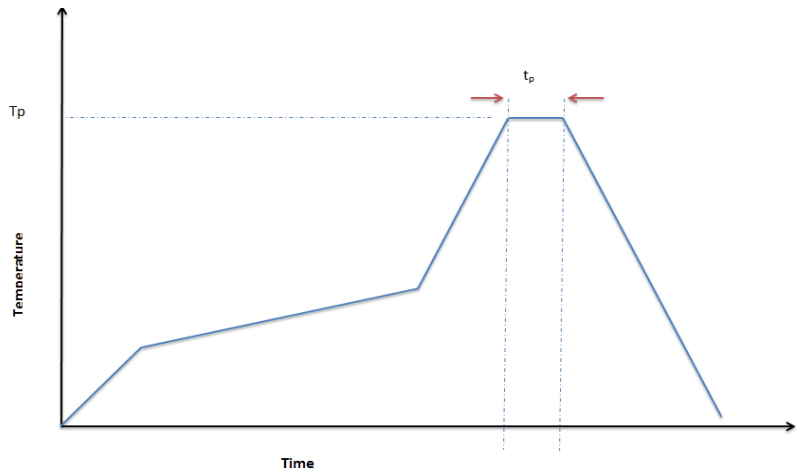

## Additional Environmental Conditions

| Parameter                      | Description  |
|--------------------------------|--|
| Temperature Cycling            | JESD22-A104-D Cond.G - 500cycles -40/+125C;cycle time 30min  |
| Vibration, Sine                | MIL-STD-883 Meth 2007 Cond A - 20g 20-2000Hz 4x in each 3 axis 4min sweep time   |
| Mechanical Shock               | MIL-STD-202 Meth 213B Cond. F - 1500g 0,5ms 6 shocks in each direction   |
| Solderability                  | J-STD-002C Cond. A, Trough hole device; Cond.B, SMD ( correspond to MIL-STD-883 Meth 2003) - 255C (diving Time 5 0,5sec.) Dip&Look with 8h damp pre-treatment: solder wetting >95% |
| Solvent resistance             | MIL-STD-883 Meth 2003) - 255C (diving Time 5 0,5sec.) Dip&Look with  |
| ESD                            | 8h damp pre-treatment: solder wetting >95%   |
| Moisture Sensit.               | JESD22-A113-B - only if > MSL 1  |
| RoHS compliance                | 100% RoHS 6 compliant  |
| Washable                       | non-washable device  |
| High temp operating life(HTOL) | MIL-STD-202 Meth108A Cond C - 1000h @ 105C power on  |
| Low temp operating life(LTOL)  | IEC 60068-2-1 Cond. Ae - 1000h @ -40C power on   |

## Ordering Information

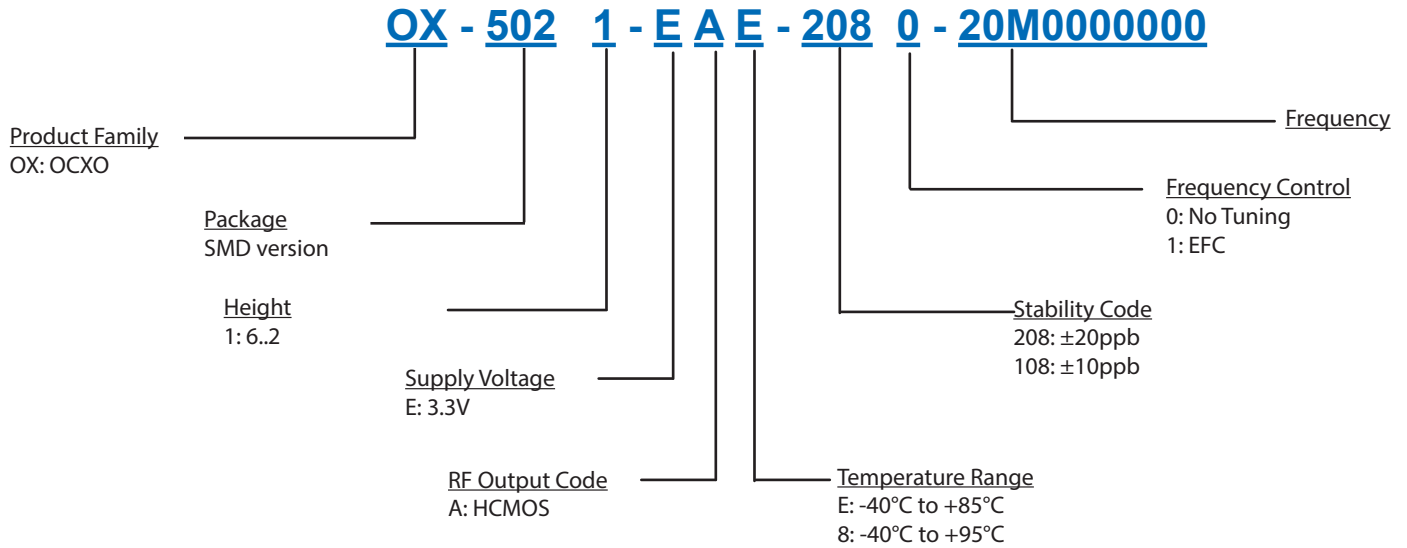

**Notes:**

1. Contact factory for improved stabilities or additional product options. Not all options and codes are available at all frequencies.
2. Unless other stated all values are valid after warm-up time and refer to typical conditions for supply voltage, frequency control voltage, load, temperature (25°C).
3. Phase noise degrades with increasing output frequency.
4. Subject to technical modification.
5. Contact factory for availability.

## Contact Information

**USA:**

100 Watts Street  
Mt Holly Springs, PA 17065  
Tel: 1.717.486.3411  
Fax: 1.717.486.5920

**Europe:**

Landstrasse  
74924 Neckarbischofsheim  
Germany  
Tel: +49 (0) 7268.801.0  
Fax: +49 (0) 7268.801.281



Information contained in this publication regarding device applications and the like is provided only for your convenience and may be superseded by updates. It is your responsibility to ensure that your application meets with your specifications. MICROCHIP MAKES NO REPRESENTATION OR WARRANTIES OF ANY KIND WHETHER EXPRESS OR IMPLIED, WRITTEN OR ORAL, STATUTORY OR OTHERWISE, RELATED TO THE INFORMATION INCLUDING, BUT NOT LIMITED TO ITS CONDITION, QUALITY, PERFORMANCE, MERCHANTABILITY OR FITNESS FOR PURPOSE. Microchip disclaims all liability arising from this information and its use. Use of Microchip devices in life support and/or safety applications is entirely at the buyer's risk, and the buyer agrees to defend, indemnify and hold harmless Microchip from any and all damages, claims, suits, or expenses resulting from such use. No licenses are conveyed, implicitly, or otherwise, under any Microchip intellectual property rights unless otherwise stated.

**Trademarks**

The Microchip and Vectron names and logos are registered trademarks of Microchip Technology Incorporated in the U.S.A. and other countries.

# typical performance data

## typical warm up (frequency vs. time)

@ OX-5021-EAE-1080-20M000

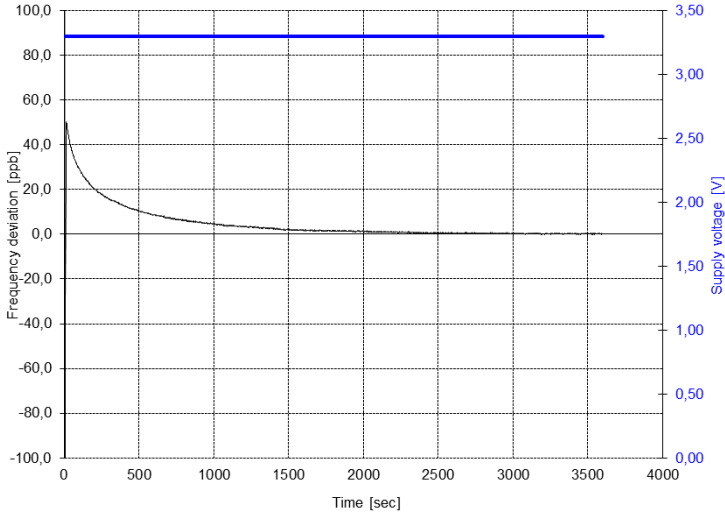

## typical current consumption during power on

@ OX-5021-EAE-1080-20M000

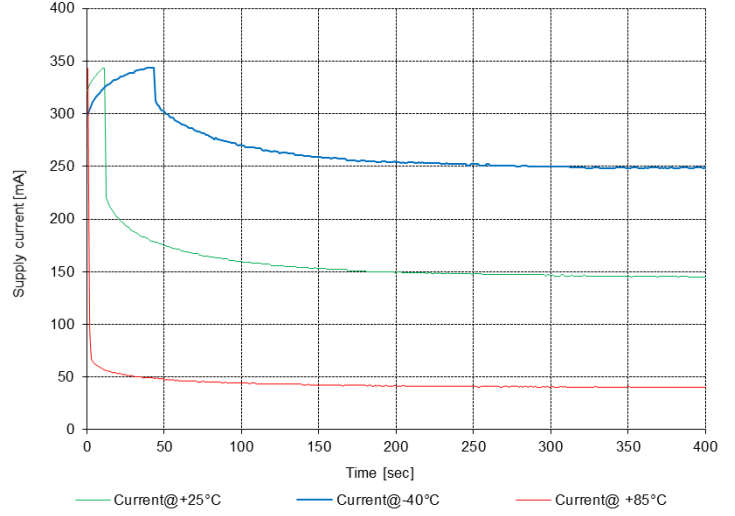

## typical power consumption vs. operating temperature

@ OX-5021-EAE-1080-20M000

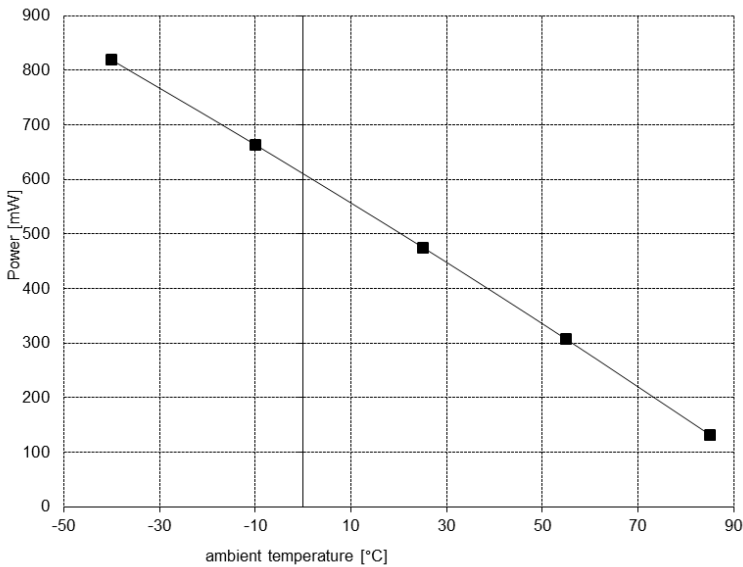

## typical frequency vs. temperature stability

@ OX-5021-EAE-1080-20M000

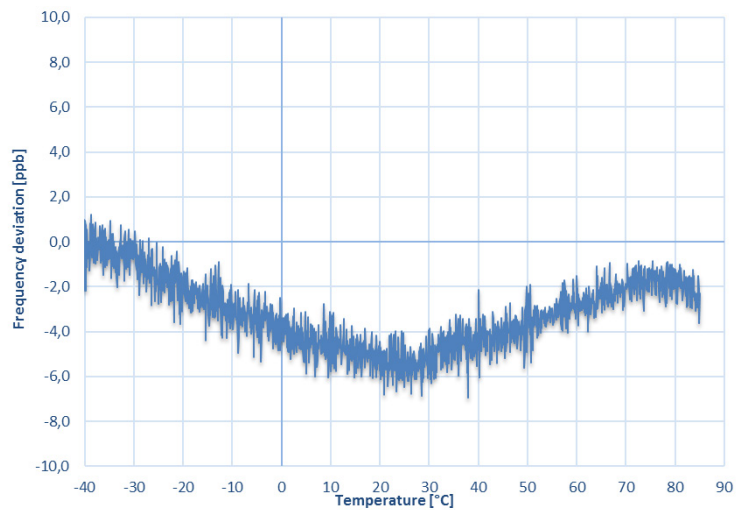

# typical performance data

## typical frequency vs. load change

@ OX-5021-EAE-1080-20M000

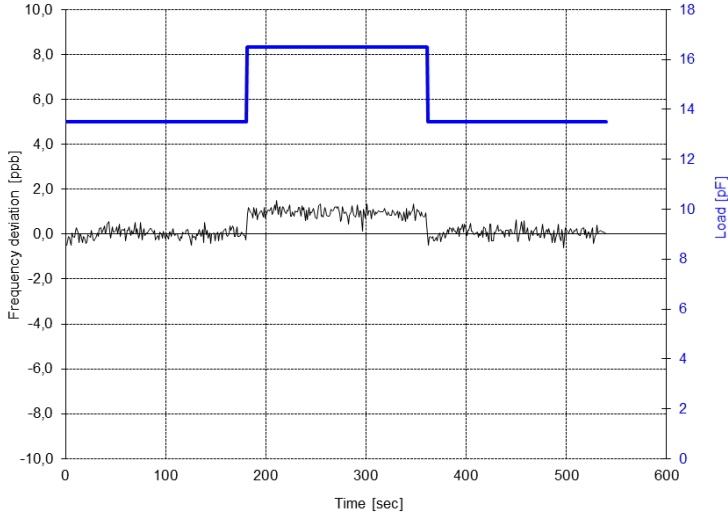

## typical frequency vs. supply voltage

@ OX-5021-EAE-1080-20M000

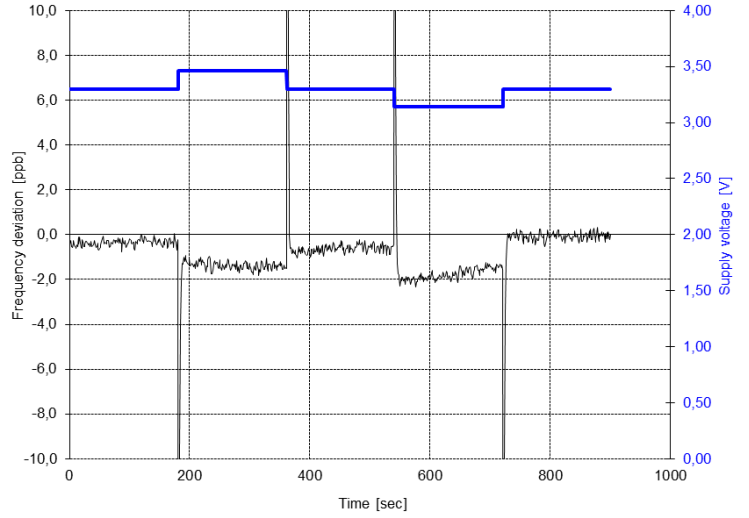

## typical frequency. vs cycled airflow without additional cover

@ OX-5021-EAE-1080-20M000

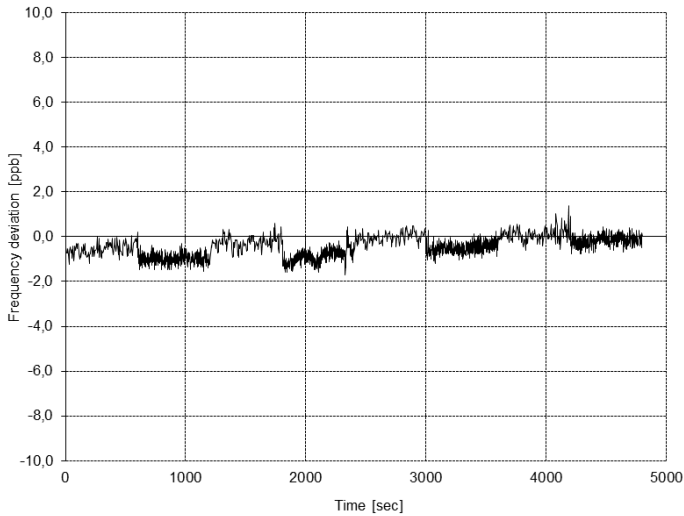

## typical frequency. vs cycled airflow with additional cover

@ OX-5021-EAE-1080-20M000

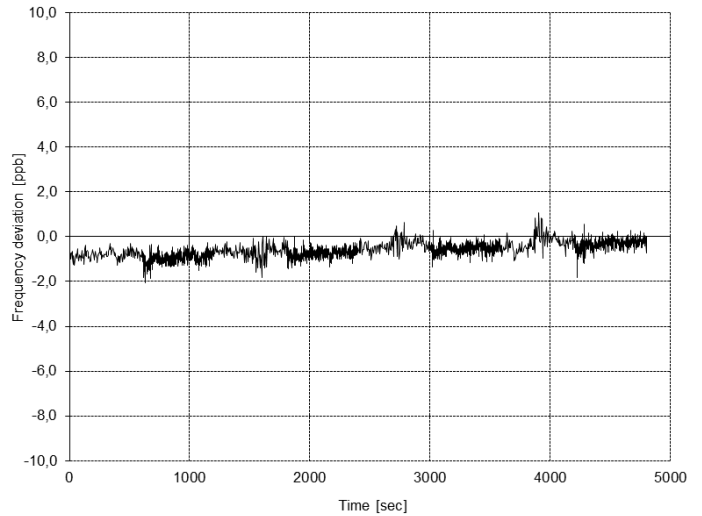

# typical performance data

**typical MTIE @ 3mHz loop Bandwidth**

@ OX-5021-EAE-1080-20M000

**typical TDEV @ 3mHz loop Bandwidth**

@ OX-5021-EAE-1080-20M000

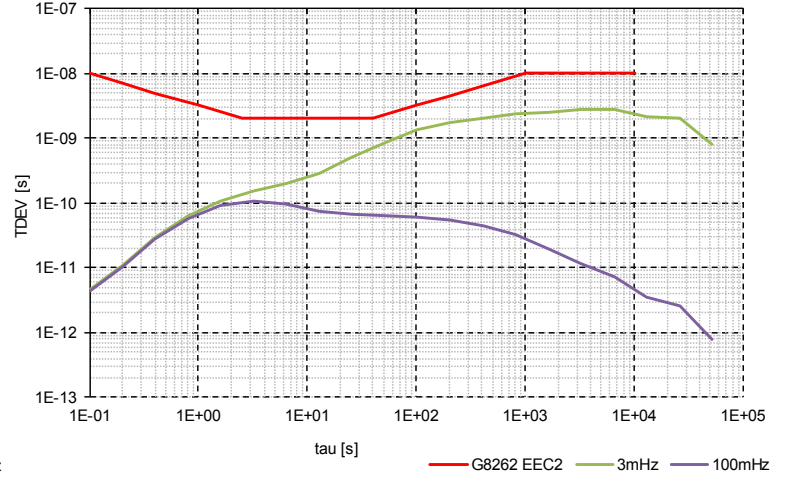
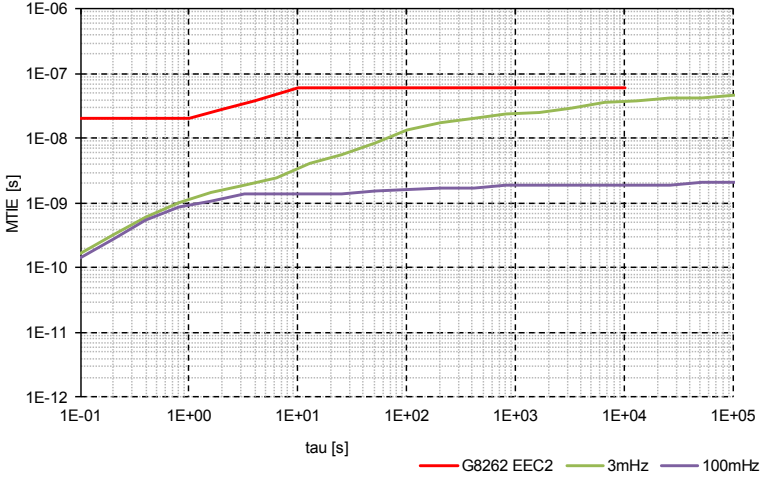

Компания «Океан Электроники» предлагает заключение долгосрочных отношений при поставках импортных электронных компонентов на взаимовыгодных условиях!

Наши преимущества:

- Поставка оригинальных импортных электронных компонентов напрямую с производств Америки, Европы и Азии, а так же с крупнейших складов мира;
- Широкая линейка поставок активных и пассивных импортных электронных компонентов (более 30 млн. наименований);
- Поставка сложных, дефицитных, либо снятых с производства позиций;
- Оперативные сроки поставки под заказ (от 5 рабочих дней);
- Экспресс доставка в любую точку России;
- Помощь Конструкторского Отдела и консультации квалифицированных инженеров;
- Техническая поддержка проекта, помощь в подборе аналогов, поставка прототипов;
- Поставка электронных компонентов под контролем ВП;
- Система менеджмента качества сертифицирована по Международному стандарту ISO 9001;
- При необходимости вся продукция военного и аэрокосмического назначения проходит испытания и сертификацию в лаборатории (по согласованию с заказчиком);
- Поставка специализированных компонентов военного и аэрокосмического уровня качества (Xilinx, Altera, Analog Devices, Intersil, Interpoint, Microsemi, Actel, Aeroflex, Peregrine, VPT, Syfer, Eurofarad, Texas Instruments, MS Kennedy, Miteq, Cobham, E2V, MA-COM, Hittite, Mini-Circuits, General Dynamics и др.);

Компания «Океан Электроники» является официальным дистрибьютором и эксклюзивным представителем в России одного из крупнейших производителей разъемов военного и аэрокосмического назначения «JONHON», а так же официальным дистрибьютором и эксклюзивным представителем в России производителя высокотехнологичных и надежных решений для передачи СВЧ сигналов «FORSTAR».



## JONHON

«JONHON» (основан в 1970 г.)

Разъемы специального, военного и аэрокосмического назначения:

(Применяются в военной, авиационной, аэрокосмической, морской, железнодорожной, горно- и нефтедобывающей отраслях промышленности)

«FORSTAR» (основан в 1998 г.)

ВЧ соединители, коаксиальные кабели, кабельные сборки и микроволновые компоненты:

(Применяются в телекоммуникациях гражданского и специального назначения, в средствах связи, РЛС, а так же военной, авиационной и аэрокосмической отраслях промышленности).



Телефон: 8 (812) 309-75-97 (многоканальный)

Факс: 8 (812) 320-03-32

Электронная почта: [ocean@oceanchips.ru](mailto:ocean@oceanchips.ru)

Web: <http://oceanchips.ru/>

Адрес: 198099, г. Санкт-Петербург, ул. Калинина, д. 2, корп. 4, лит. А