



## Programmable Low-Jitter Precision CMOS Oscillator

### General Description

The DSC8101 & DSC8121 series of high performance field-programmable oscillators utilizes a proven silicon MEMS technology to provide excellent jitter and stability over a wide range of supply voltages and temperatures. Using the TIMEFLASH programmer, the end user can easily program the oscillators' frequency in the field for immediate testing or use in advance prototype development or production.

DSC8101 has a standby feature allowing it to completely power-down when EN pin is pulled low; whereas for DSC8121, only the outputs are disabled when EN is low. Both oscillators are available in industry standard packages, including the small 3.2x2.5 mm<sup>2</sup>, and are "drop-in" replacement for standard 4-pin CMOS quartz oscillators.

### Block Diagram

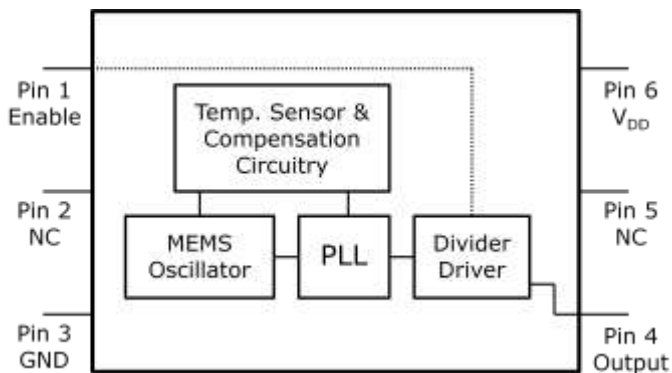

### Output Enable Modes

EN Pin	DSC8101	DSC8121
High	Output Active	Output Active
NC	Output Active	Output Active
Low	Standby	Output Disabled

### Features

- **Low RMS Phase Jitter: <1 ps (typ)**
- **High Stability: ±10, ±25, ±50 ppm**
- **Wide Temperature Range**
  - Automotive: -55° to 125° C
  - Ext. Industrial: -40° to 105° C
  - Industrial: -40° to 85° C
  - Ext. commercial: -20° to 70° C
- **High Supply Noise Rejection: -50 dBc**
- **Short Lead Time: 2 Weeks**
- **Wide Freq. Range: 10 to 170 MHz**
- **Small Industry Standard Footprints**
  - 2.5x2.0, 3.2x2.5, 5.0x3.2, & 7.0x5.0 mm
- **Excellent Shock & Vibration Immunity**
  - Qualified to MIL-STD-883
- **High Reliability**
  - 20x better MTF than quartz oscillators
- **Low Current Consumption**
- **Supply Range of 2.25 to 3.6 V**
- **Standby & Output Enable Function**
- **Lead Free & RoHS Compliant**

### Applications

- **Storage Area Networks**
  - SATA, SAS, Fibre Channel
- **Passive Optical Networks**
  - EPON, 10G-EPON, GPON, 10G-PON
- **Ethernet**
  - 1G, 10GBASE-T/KR/LR/SR, and FCoE
- **HD/SD/SDI Video & Surveillance**
- **PCI Express**
- **DisplayPort**

## Absolute Maximum Ratings

Item	Min	Max	Unit	Condition
Supply Voltage	-0.3	+4.0	V	
Input Voltage	-0.3	$V_{DD}+0.3$	V	
Junction Temp	-	+150	°C	
Storage Temp	-55	+150	°C	
Soldering Temp	-	+260	°C	40sec max.
ESD	-		V	
HBM		4000		
MM		400		
CDM		1500		

Note: 1000+ years of data retention on internal memory

## Ordering Code

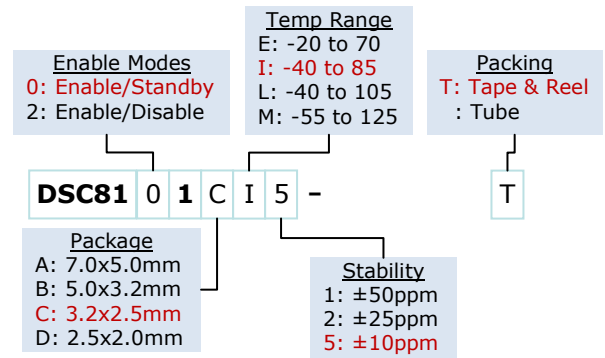

## Specifications

Parameter	Condition	Min.	Typ.	Max.	Unit
Supply Voltage <sup>1</sup>	$V_{DD}$	2.25		3.6	V
Supply Current	$I_{DD}$ EN pin low – output is disabled DSC8101 DSC8121		20	0.095 22	mA
Frequency Stability Ext Comm. & Ind. only All temp ranges All temp ranges	$\Delta f$ Includes frequency variations due to initial tolerance, temp. and power supply voltage			±10 ±25 ±50	ppm
Aging	$\Delta f$ 1 year @25°C			±5	ppm
Startup Time <sup>2</sup>	$t_{SU}$ T=25°C			5	ms
Input Logic Levels Input logic high Input logic low	$V_{IH}$ $V_{IL}$	0.75x $V_{DD}$ -		- 0.25x $V_{DD}$	V
Output Disable Time <sup>3</sup>	$t_{DA}$			5	ns
Output Enable Time	$t_{EN}$ DSC8101 DSC8121			5 20	ms ns
Enable Pull-Up Resistor <sup>4</sup>	Pull-up resistor exist		40		kΩ
CMOS Output					
Supply Current <sup>4</sup>	$I_{DD}$ output is enabled $C_L=15pF$ , $F_0=125$ MHz		31	35	mA
Output Logic Levels Output logic high Output logic low	$V_{OH}$ $V_{OL}$ I=±6mA	0.9x $V_{DD}$ -		- 0.1x $V_{DD}$	V
Output Transition time <sup>3</sup> Rise Time Fall Time	$t_R$ $t_F$ 20% to 80% $C_L=15pF$		1.1 1.3	2 2	ns
Frequency	$f_0$ All temp range except Auto Auto temp range	10		170 100	MHz
Output Duty Cycle	SYM	45		55	%
Period Jitter	$J_{PER}$ Fout=125MHz		3		ps <sub>RMS</sub>
Integrated Phase Noise	$J_{PH}$ 200kHz to 20MHz @ 125MHz 100kHz to 20MHz @ 125MHz 12kHz to 20MHz @ 125MHz		0.3 0.38 1.7	2	ps <sub>RMS</sub>

- Pin 6  $V_{DD}$  should be filtered with 0.1uF capacitor.
- $t_{SU}$  is time to 100PPM of output frequency after  $V_{DD}$  is applied and outputs are enabled.
- Output Waveform and Test Circuit figures below define the parameters.
- Output is enabled if pad is floated or not connected.

**Nominal Performance Parameters** (Unless specified otherwise:  $T=25^{\circ}C$ ,  $V_{DD}=3.3V$ )

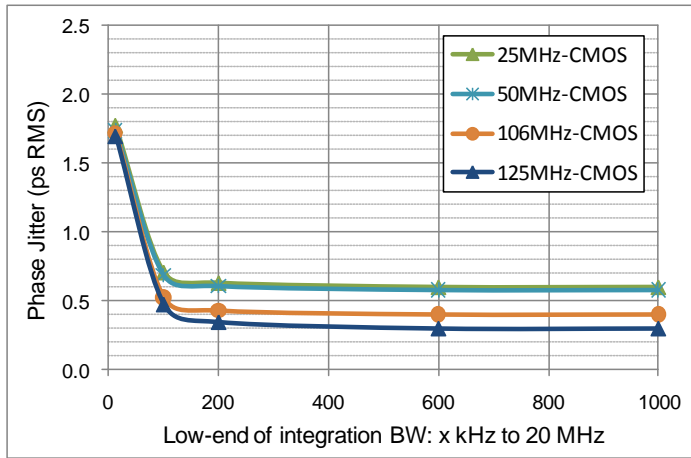

Phase jitter (integrated phase noise)

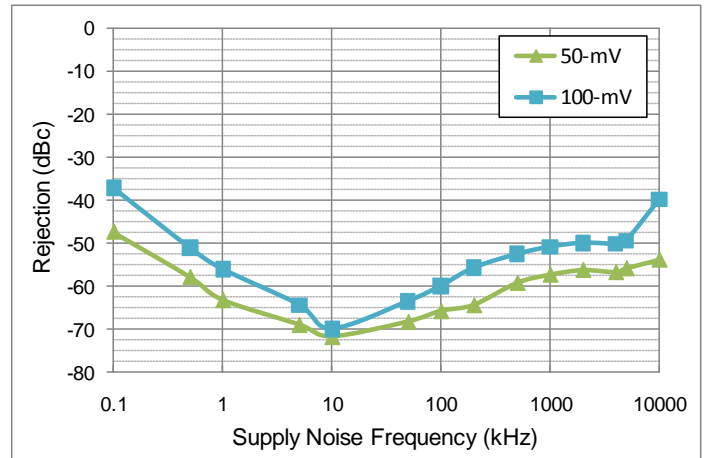

Power supply rejection ratio

**Output Waveform**

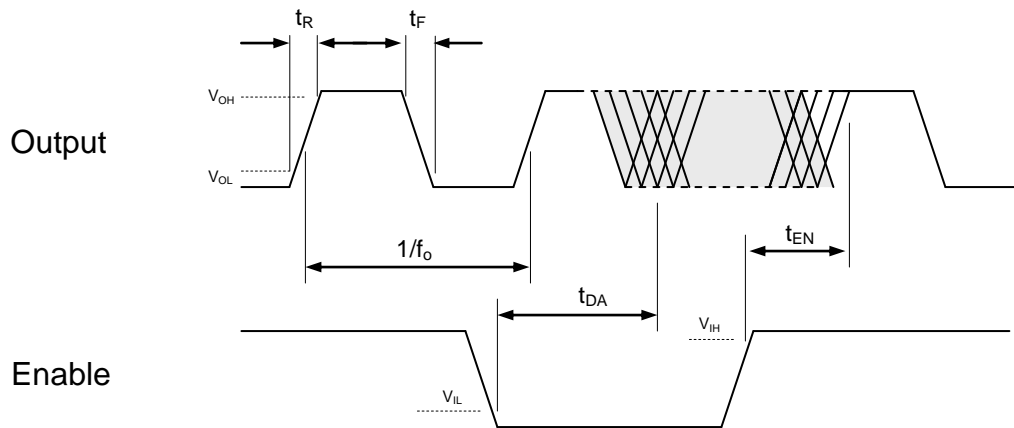

**Typical Termination Scheme**

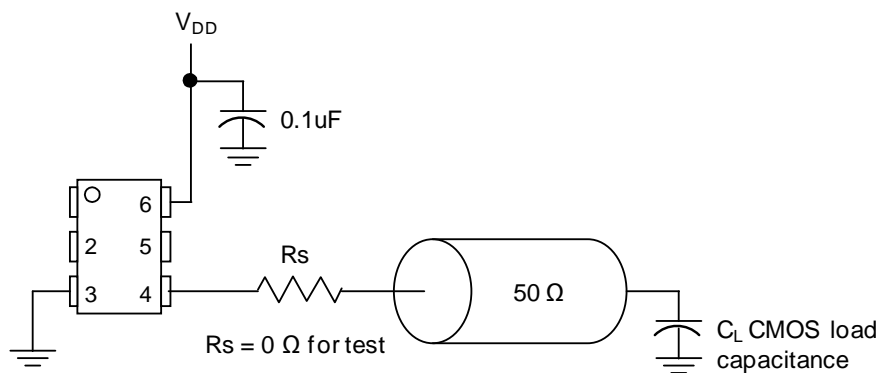

$R_s$  serves to match the trace impedances. Depending on board layout, the value may range from 0 to 30 ohms.

## Test Circuit

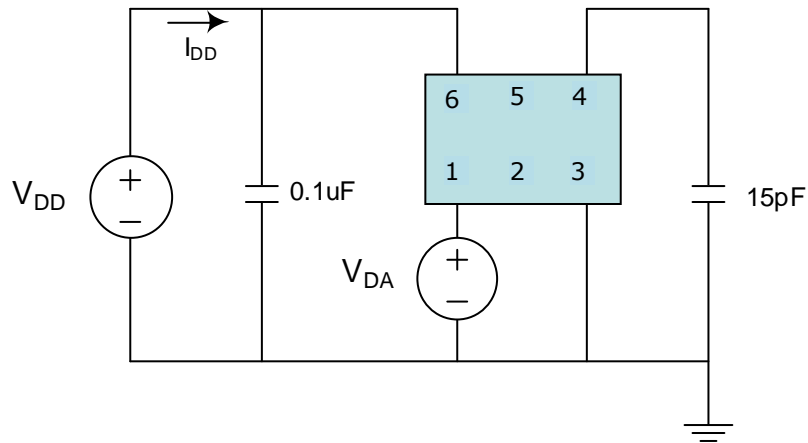

## Board Layout (recommended)

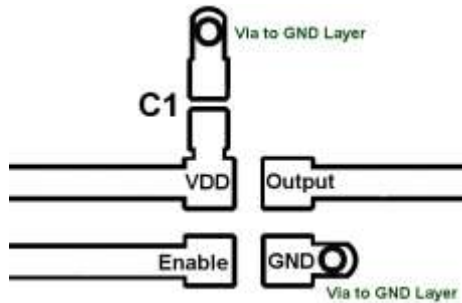

## Solder Reflow Profile

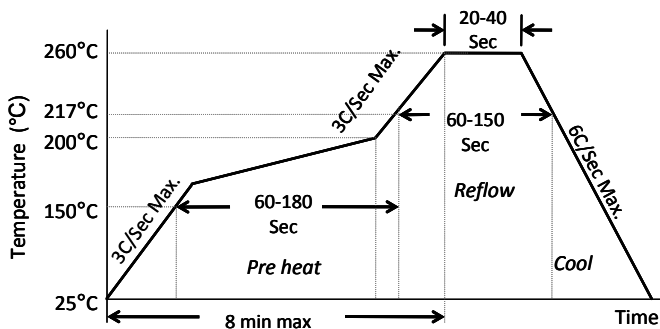

MSL 1 @ 260°C refer to JSTD-020C	
Ramp-Up Rate (200°C to Peak Temp)	3°C/Sec Max.
Preheat Time 150°C to 200°C	60-180 Sec
Time maintained above 217°C	60-150 Sec
Peak Temperature	255-260°C
Time within 5°C of actual Peak	20-40 Sec
Ramp-Down Rate	6°C/Sec Max.
Time 25°C to Peak Temperature	8 min Max.

## Package Dimensions

### 7.0 x 5.0 mm Plastic Package

External Dimensions  
units: mm[inch]

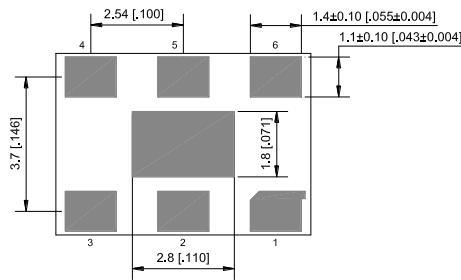
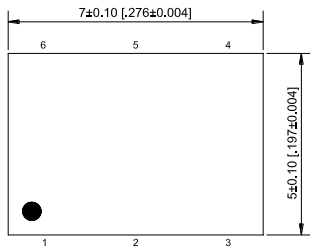

Recommended Solder Pad Layout  
units: mm[inch]

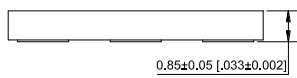
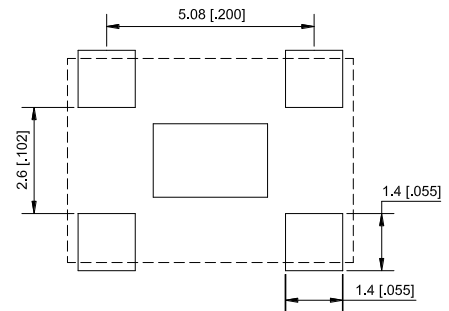

No.	Pin terminal
1	Enable
2	nc
3	GND
4	Output
5	nc
6	VDD

### 5.0 x 3.2 mm Plastic Package

External Dimensions  
units: mm[inch]

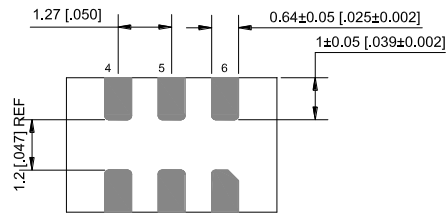
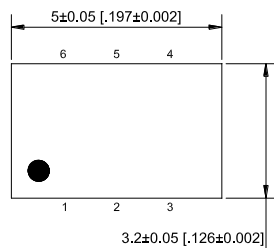

Recommended Solder Pad Layout  
units: mm[inch]

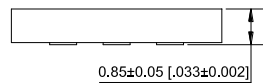
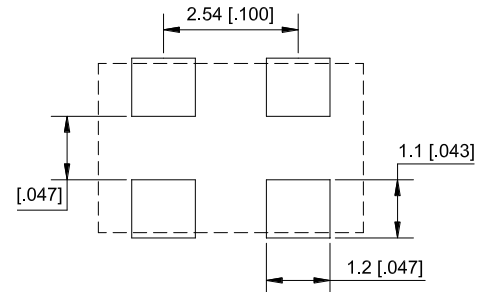

No.	Pin terminal
1	Enable
2	nc
3	GND
4	Output
5	nc
6	VDD

## 3.2 x 2.5 mm Plastic Package

External Dimensions  
units: mm[inch]

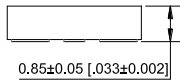
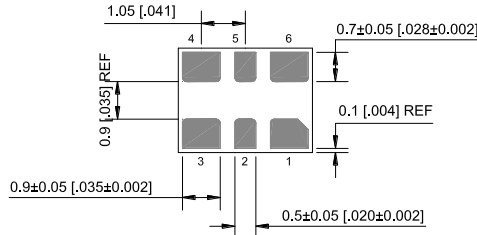
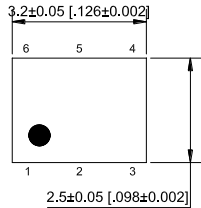

No.	Pin terminal
1	Enable
2	nc
3	GND
4	Output
5	nc
6	VDD

Recommended  
Solder Pad Layout  
units: mm[inch]

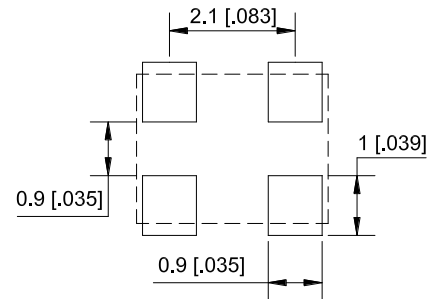

## 2.5 x 2.0 mm Plastic Package

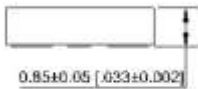
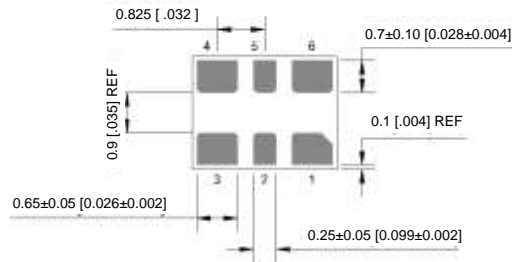
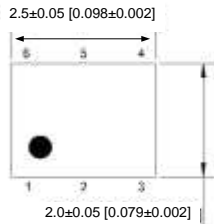

No.	Pin terminal
1	Enable
2	nc
3	GND
4	Output
5	Output
6	VDD

Recommended  
Solder Pad Layout  
units: mm[inch]

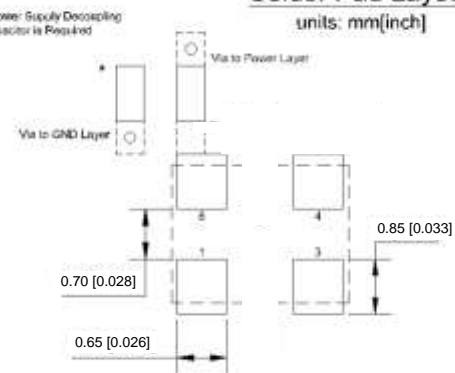

### Disclaimer:

Micrel makes no representations or warranties with respect to the accuracy or completeness of the information furnished in this data sheet. This information is not intended as a warranty and Micrel does not assume responsibility for its use. Micrel reserves the right to change circuitry, specifications and descriptions at any time without notice. No license, whether express, implied, arising by estoppel or otherwise, to any intellectual property rights is granted by this document. Except as provided in Micrel's terms and conditions of sale for such products, Micrel assumes no liability whatsoever, and Micrel disclaims any express or implied warranty relating to the sale and/or use of Micrel products including liability or warranties relating to fitness for a particular purpose, merchantability, or infringement of any patent, copyright or other intellectual property right.

MICREL, Inc.  
Phone: +1 (408) 944-0800

• 2180 Fortune Drive,  
• Fax: +1 (408) 474-1000

San Jose, California 95131  
• Email: [hbwhelp@micrel.com](mailto:hbwhelp@micrel.com)

• USA  
• [www.micrel.com](http://www.micrel.com)

Компания «Океан Электроники» предлагает заключение долгосрочных отношений при поставках импортных электронных компонентов на взаимовыгодных условиях!

Наши преимущества:

- Поставка оригинальных импортных электронных компонентов напрямую с производств Америки, Европы и Азии, а так же с крупнейших складов мира;
- Широкая линейка поставок активных и пассивных импортных электронных компонентов (более 30 млн. наименований);
- Поставка сложных, дефицитных, либо снятых с производства позиций;
- Оперативные сроки поставки под заказ (от 5 рабочих дней);
- Экспресс доставка в любую точку России;
- Помощь Конструкторского Отдела и консультации квалифицированных инженеров;
- Техническая поддержка проекта, помощь в подборе аналогов, поставка прототипов;
- Поставка электронных компонентов под контролем ВП;
- Система менеджмента качества сертифицирована по Международному стандарту ISO 9001;
- При необходимости вся продукция военного и аэрокосмического назначения проходит испытания и сертификацию в лаборатории (по согласованию с заказчиком);
- Поставка специализированных компонентов военного и аэрокосмического уровня качества (Xilinx, Altera, Analog Devices, Intersil, Interpoint, Microsemi, Actel, Aeroflex, Peregrine, VPT, Syfer, Eurofarad, Texas Instruments, MS Kennedy, Miteq, Cobham, E2V, MA-COM, Hittite, Mini-Circuits, General Dynamics и др.);

Компания «Океан Электроники» является официальным дистрибьютором и эксклюзивным представителем в России одного из крупнейших производителей разъемов военного и аэрокосмического назначения «JONHON», а так же официальным дистрибьютором и эксклюзивным представителем в России производителя высокотехнологичных и надежных решений для передачи СВЧ сигналов «FORSTAR».



## JONHON

«JONHON» (основан в 1970 г.)

Разъемы специального, военного и аэрокосмического назначения:

(Применяются в военной, авиационной, аэрокосмической, морской, железнодорожной, горно- и нефтедобывающей отраслях промышленности)

«FORSTAR» (основан в 1998 г.)

ВЧ соединители, коаксиальные кабели, кабельные сборки и микроволновые компоненты:

(Применяются в телекоммуникациях гражданского и специального назначения, в средствах связи, РЛС, а так же военной, авиационной и аэрокосмической отраслях промышленности).



Телефон: 8 (812) 309-75-97 (многоканальный)

Факс: 8 (812) 320-03-32

Электронная почта: [ocean@oceanchips.ru](mailto:ocean@oceanchips.ru)

Web: <http://oceanchips.ru/>

Адрес: 198099, г. Санкт-Петербург, ул. Калинина, д. 2, корп. 4, лит. А