

MAX9914–MAX9917

1MHz, 20µA, Rail-to-Rail I/O Op Amps with Shutdown

General Description

The single MAX9914/MAX9915 and dual MAX9916/MAX9917 operational amplifiers feature maximized ratio of gain bandwidth to supply current and are ideal for battery-powered applications such as portable instrumentation, portable medical equipment, and wireless handsets. These CMOS op amps feature an ultra-low 1pA input bias current, rail-to-rail inputs and outputs, low 20µA supply current, and operate from a single 1.8V to 5.5V supply. For additional power conservation, the MAX9915/MAX9917 feature a low-power shutdown mode that reduces supply current to 1nA, and puts the amplifier outputs in a high-impedance state. These devices are unity-gain stable with a 1MHz gain-bandwidth product.

The MAX9914 and MAX9915 are available in 5-pin and 6-pin SC70 packages, respectively. The MAX9916 is available in an 8-pin SOT23 package, and the MAX9917 in a 10-pin µMAX® package. All devices are specified over the -40°C to +85°C extended operating temperature range.

Applications

- Portable Medical Devices
- Portable Test Equipment
- RF Tags
- Laptops
- Data-Acquisition Equipment

Typical Operating Circuit

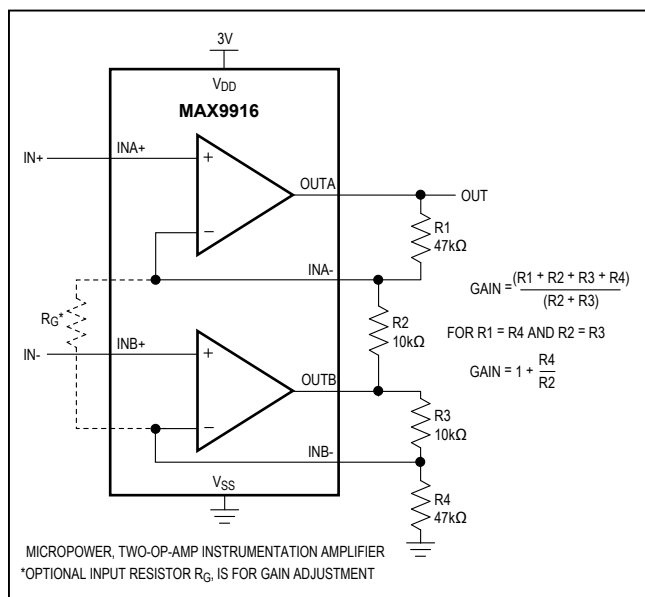

Features

- High 1MHz GBW
- Ultra-Low 20µA Supply Current
- Single 1.8V to 5.5V Supply Voltage Range
- Ultra-Low 1pA Input Bias Current
- Rail-to-Rail Input and Output Voltage Ranges
- Low ±200µV Input Offset Voltage
- Low 0.001µA Shutdown Current
- High-Impedance Output During Shutdown (MAX9915/MAX9917)
- Unity-Gain Stable
- Available in Tiny SC70, SOT23, and µMAX Packages

Ordering Information

PART	TEMP RANGE	PIN-PACKAGE	TOP MARK
MAX9914EXK+T	-40°C to +85°C	5 SC70	AGB
MAX9914EXK-T	-40°C to +85°C	5 SC70	AGB
MAX9915EXT+T	-40°C to +85°C	6 SC70	ACB
MAX9915EXT-T	-40°C to +85°C	6 SC70	ACB
MAX9916EKA+T	-40°C to +85°C	8 SOT23	AEJZ
MAX9916EKA-T	-40°C to +85°C	8 SOT23	AEJZ
MAX9917EUB	-40°C to +85°C	10 µMAX	—
MAX9917EUB+	-40°C to +85°C	10 µMAX	—

+Denotes a lead(Pb)-free/RoHS-compliant package.

T = Tape and reel.

Selector Guide

PART	AMPLIFIERS PER PACKAGE	SHUTDOWN MODE	PACKAGE
MAX9914EXK+T	1	No	5 SC70
MAX9915EXT+T	1	Yes	6 SC70
MAX9916EKA+T	2	No	8 SOT23
MAX9917EUB+	2	Yes	10 µMAX

µMAX is a registered trademark of Maxim Integrated Products, Inc.



Absolute Maximum Ratings

Power-Supply Voltage (V_{DD} to V_{SS}).....	-0.3V to +6.0V	8-Pin SOT23 (derate 5.1mW/°C above +70°C)	408mW
IN_+ , IN_- , OUT_+ , $SHDN_+$	($V_{SS} - 0.3V$) to ($V_{DD} + 0.3V$)	10-Pin µMAX (derate 5.6mW/°C above +70°C).....	444mW
Current into IN_+ , IN_-	±20mA	Operating Temperature Range.....	-40°C to +85°C
Output Short-Circuit Duration to V_{DD} or V_{SS}	Continuous	Junction Temperature.....	+150°C
Continuous Power Dissipation ($T_A = +70°C$)		Storage Temperature Range.....	-65°C to +150°C
5-Pin SC70 (derate 3.1mW/°C above +70°C).....	247mW	Lead Temperature (soldering, 10s)	+300°C
6-Pin SC70 (derate 3.1mW/°C above +70°C).....	245mW	Soldering Temperature (reflow).....	+260°C

Stresses beyond those listed under "Absolute Maximum Ratings" may cause permanent damage to the device. These are stress ratings only, and functional operation of the device at these or any other conditions beyond those indicated in the operational sections of the specifications is not implied. Exposure to absolute maximum rating conditions for extended periods may affect device reliability.

Electrical Characteristics

($V_{DD} = 1.8V$ to $5.5V$, $V_{SS} = 0V$, $V_{CM} = 0V$, $V_{OUT} = V_{DD}/2$, $R_L = \infty$ connected to $V_{DD}/2$, $SHDN_+ = V_{DD}$, $T_A = +25°C$, unless otherwise noted.) (Note 1)

PARAMETER	SYMBOL	CONDITIONS	MIN	TYP	MAX	UNITS
Supply Voltage Range	V_{DD}	Guaranteed by PSRR test	1.8		5.5	V
Supply Current	I_{DD}	MAX9914/MAX9915	$V_{DD} = 1.8V$	20		µA
			$V_{DD} = 5.5V$	20	25	
		MAX9916/MAX9917	$V_{DD} = 1.8V$	40		
			$V_{DD} = 5.5V$	40	50	
Shutdown Supply Current	$I_{DD}(SHDN_+)$	$SHDN_+ = GND$, MAX9915/MAX9917		0.001	0.5	µA
Input Offset Voltage	V_{OS}			±0.2	±1	mV
Input-Offset-Voltage Matching		MAX9916/MAX9917		±250		µV
Input Bias Current	I_B	(Note 2)		±1	±10	pA
Input Offset Current	I_{OS}	(Note 2)		±1	±10	pA
Input Resistance	R_{IN}	Common mode		1		GΩ
		Differential mode, $-1mV < V_{IN} < +1mV$		10		
Input Common-Mode Range	V_{CM}	Guaranteed by CMRR test	$V_{SS} - 0.1$		$V_{DD} + 0.1$	V
Common-Mode Rejection Ratio	CMRR	$-0.1V < V_{CM} < V_{DD} + 0.1V$, $V_{DD} = 5.5V$	70	80		dB
Power-Supply Rejection Ratio	PSRR	$1.8V < V_{DD} < 5.5V$	65	85		dB
Open-Loop Gain	A_{VOL}	$25mV < V_{OUT} < V_{DD} - 25mV$, $R_L = 100k\Omega$, $V_{DD} = 5.5V$	95	120		dB
		$100mV < V_{OUT} < V_{DD} - 100mV$, $R_L = 5k\Omega$, $V_{DD} = 5.5V$	95	110		
Output-Voltage-Swing High	V_{OH}	$V_{DD} - V_{OUT}$	$R_L = 100k\Omega$	2.5	5	mV
			$R_L = 5k\Omega$	50	70	
			$R_L = 1k\Omega$	250		
Output-Voltage-Swing Low	V_{OL}	$V_{OUT} - V_{SS}$	$R_L = 100k\Omega$	2.5	5	mV
			$R_L = 5k\Omega$	50	70	
			$R_L = 1k\Omega$	250		
Channel-to-Channel Isolation	CH_{ISO}	Specified at DC, MAX9916/MAX9917		100		dB
Output Short-Circuit Current	$I_{OUT(SC)}$			±15		mA

Electrical Characteristics (continued)

($V_{DD} = 1.8V$ to $5.5V$, $V_{SS} = 0V$, $V_{CM} = 0V$, $V_{OUT} = V_{DD}/2$, $R_L = \infty$ connected to $V_{DD}/2$, $\overline{SHDN}_- = V_{DD}$, $T_A = +25^\circ C$, unless otherwise noted.) (Note 1)

PARAMETER	SYMBOL	CONDITIONS		MIN	TYP	MAX	UNITS
\overline{SHDN}_- Logic Low	V_{IL}	$V_{DD} = 1.8V$ to $3.6V$, MAX9915/MAX9917				0.4	V
		$V_{DD} = 3.6V$ to $5.5V$, MAX9915/MAX9917				0.8	
\overline{SHDN}_- Logic High	V_{IH}	$V_{DD} = 1.8V$ to $3.6V$, MAX9915/MAX9917		1.4			V
		$V_{DD} = 3.6V$ to $5.5V$, MAX9915/MAX9917		2			
\overline{SHDN}_- Input Bias Current	I_{IL}	$\overline{SHDN}_- = V_{SS}$, MAX9915/MAX9917 (Note 2)				1	nA
	I_{IH}	$\overline{SHDN}_- = V_{DD}$, MAX9915/MAX9917				500	
Output Leakage in Shutdown	$I_{OUT(\overline{SHDN}_-)}$	$\overline{SHDN}_- = V_{SS}$, $V_{OUT} = 0V$ to V_{DD} , MAX9915/MAX9917			1	500	nA
Gain-Bandwidth Product					1		MHz
Phase Margin		$C_L = 15pF$			45		degrees
Gain Margin		$C_L = 15pF$			10		dB
Slew Rate					0.5		V/µs
Capacitive-Load Stability (See the <i>Driving Capacitive Loads</i> Section)	C_{LOAD}	No sustained oscillations	$A_V = 1V/V$		30		pF
			$A_V = 10V/V$		100		
			$R_L = 5k\Omega$, $A_V = 1V/V$		100		
			$R_{ISO} = 1k\Omega$, $A_V = 1V/V$		100		
Input Voltage-Noise Density		$f = 1kHz$			160		nV/√Hz
Input Current-Noise Density		$f = 1kHz$			0.001		pA/√Hz
Settling Time		To 0.1%, $V_{OUT} = 2V$ step, $A_V = -1V/V$			3.5		µs
Delay Time to Shutdown	t_{SH}	$I_{DD} = 5\%$ of normal operation, $V_{DD} = 5.5V$, $V_{\overline{SHDN}_-} = 5.5V$ to 0 step			2		µs
Delay Time to Enable	t_{EN}	$V_{OUT} = 2.7V$, V_{OUT} settles to 0.1%, $V_{DD} = 5.5V$, $V_{\overline{SHDN}_-} = 0$ to 5.5V step			10		µs
Power-Up Time		$V_{DD} = 0$ to 5.5V step			2		µs

Electrical Characteristics

($V_{DD} = 1.8V$ to $5.5V$, $V_{SS} = 0V$, $V_{CM} = 0V$, $V_{OUT} = V_{DD}/2$, $R_L = \infty$ connected to $V_{DD}/2$, $\overline{SHDN}_- = V_{DD}$, $T_A = -40^\circ C$ to $+85^\circ C$, unless otherwise noted.) (Note 1)

PARAMETER	SYMBOL	CONDITIONS		MIN	TYP	MAX	UNITS
Supply Voltage Range	V_{DD}	Guaranteed by PSRR test		1.8		5.5	V
Supply Current	I_{DD}	MAX9914/MAX9915	$V_{DD} = 5.5V$			29	µA
		MAX9916/MAX9917				60	
Shutdown Supply Current	$I_{DD(\overline{SHDN}_-)}$	$\overline{SHDN}_- = GND$, MAX9915/MAX9917				1	µA
Input Offset Voltage	V_{OS}					±3	mV

Electrical Characteristics (continued)

(V_{DD} = 1.8V to 5.5V, V_{SS} = 0V, V_{CM} = 0V, V_{OUT} = $V_{DD}/2$, $R_L = \infty$ connected to $V_{DD}/2$, \overline{SHDN}_- = V_{DD} , T_A = -40°C to +85°C, unless otherwise noted.) (Note 1)

PARAMETER	SYMBOL	CONDITIONS	MIN	TYP	MAX	UNITS
Input-Offset-Voltage Temperature Coefficient (Note 2)	TC_{VOS}			± 5		$\mu V/^\circ C$
Input Bias Current	I_B				± 30	pA
Input Offset Current	I_{OS}				± 20	pA
Input Common-Mode Range	V_{CM}	Guaranteed by CMRR test	$V_{SS} - 0.05$		$V_{DD} + 0.05$	V
Common-Mode Rejection Ratio	CMRR	$-0.05V < V_{CM} < V_{DD} + 0.05V$, $V_{DD} = 5.5V$	60			dB
Power-Supply Rejection Ratio	PSRR	$1.8V < V_{DD} < 5.5V$	60			dB
Open-Loop Gain	A_{VOL}	$25mV < V_{OUT} < V_{DD} - 25mV$, $R_L = 100k\Omega$, $V_{DD} = 5.5V$	85			dB
		$150mV < V_{OUT} < V_{DD} - 150mV$, $R_L = 5k\Omega$, $V_{DD} = 5.5V$	85			
Output-Voltage-Swing High	V_{OH}	$V_{DD} - V_{OUT}$	$R_L = 100k\Omega$		6	mV
			$R_L = 5k\Omega$		90	
Output-Voltage-Swing Low	V_{OL}	$V_{OUT} - V_{SS}$	$R_L = 100k\Omega$		5	mV
			$R_L = 5k\Omega$		90	
\overline{SHDN}_- Logic Low	V_{IL}	$V_{DD} = 1.8V$ to 3.6V, MAX9915/MAX9917			0.4	V
		$V_{DD} = 3.6V$ to 5.5V, MAX9915/MAX9917			0.8	
\overline{SHDN}_- Logic High	V_{IH}	$V_{DD} = 1.8V$ to 3.6V, MAX9915/MAX9917	1.4			V
		$V_{DD} = 3.6V$ to 5.5V, MAX9915/MAX9917	2			
\overline{SHDN}_- Input Bias Current	I_{IL}	$\overline{SHDN}_- = V_{SS}$, MAX9915/MAX9917			5	nA
	I_{IH}	$\overline{SHDN}_- = V_{DD}$, MAX9915/MAX9917			1000	nA
Output Leakage in Shutdown	$I_{OUT(\overline{SHDN}_-)}$	$\overline{SHDN}_- = V_{SS}$, $V_{OUT} = 0V$ to V_{DD} , MAX9915/MAX9917			1000	nA

Note 1: Specifications are 100% tested at $T_A = +25^\circ C$ (exceptions noted). All temperature limits are guaranteed by design.

Note 2: Guaranteed by design, not production tested

Typical Operating Characteristics

($V_{DD} = 3V$, $V_{SS} = V_{CM} = 0V$, R_L to $V_{DD}/2$, $T_A = +25^\circ C$, unless otherwise noted.)

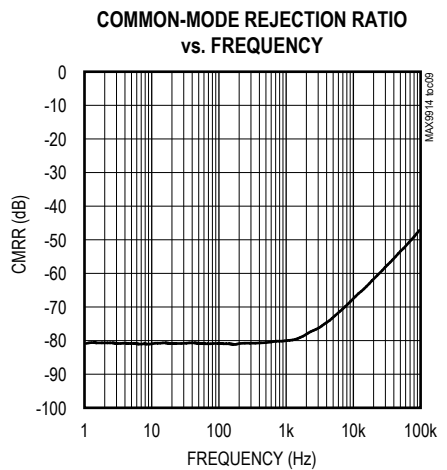
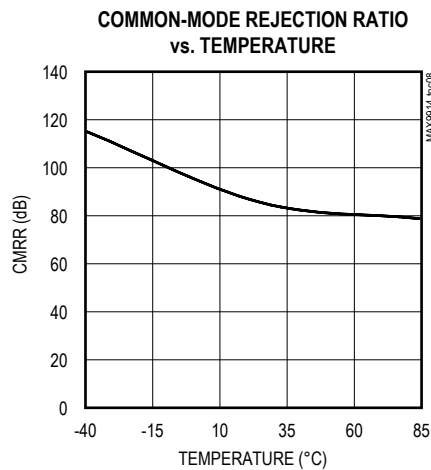
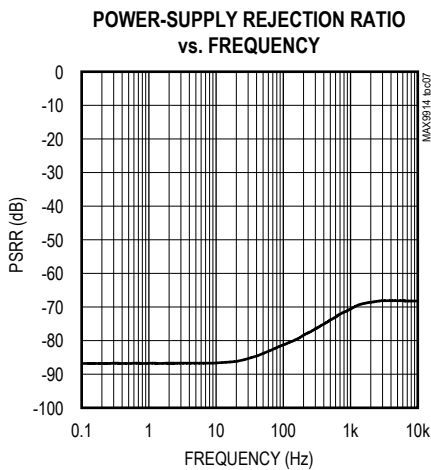
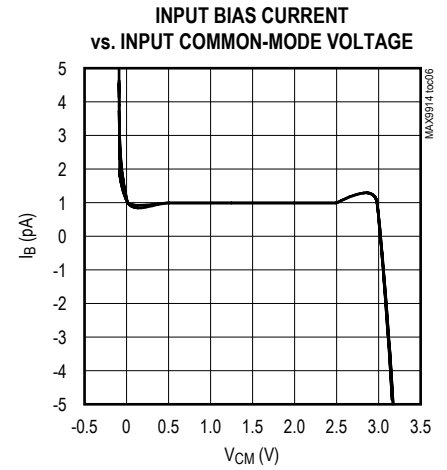
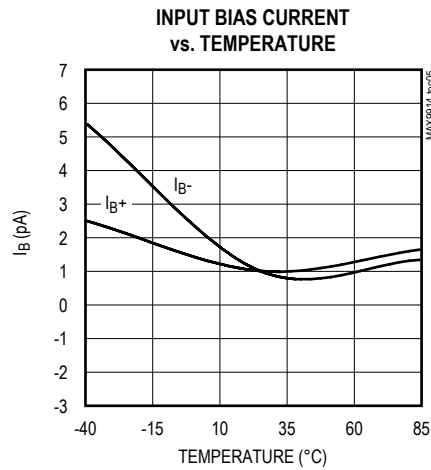
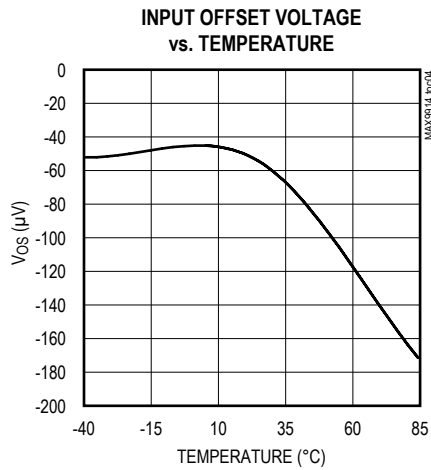
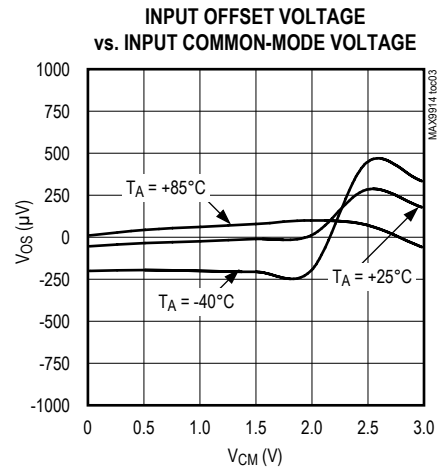
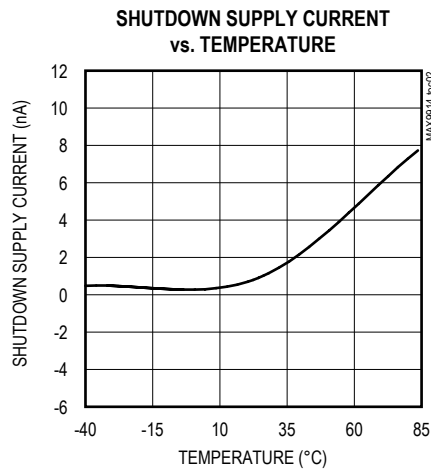
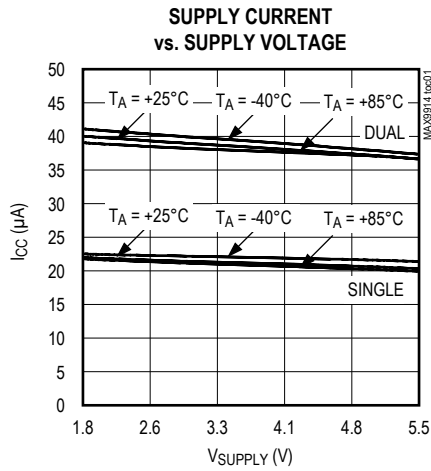

Typical Operating Characteristics (continued)

($V_{DD} = 3V$, $V_{SS} = V_{CM} = 0V$, R_L to $V_{DD}/2$, $T_A = +25^\circ C$, unless otherwise noted.)

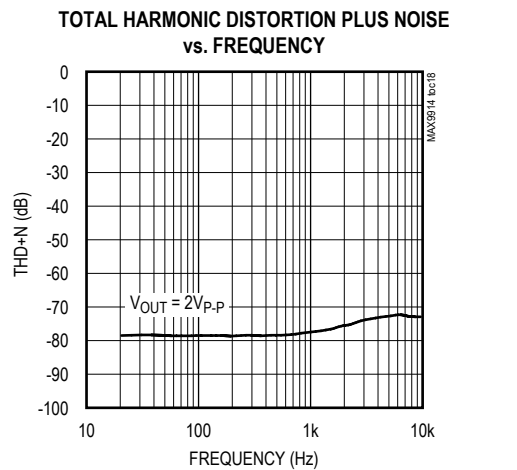
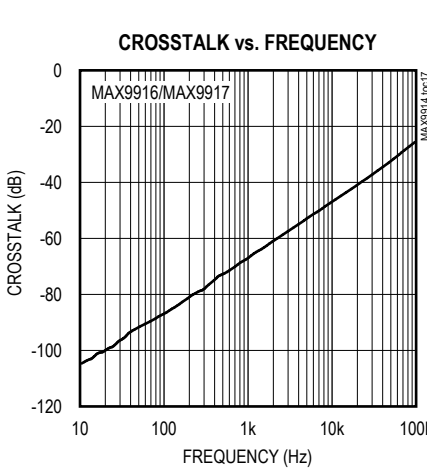
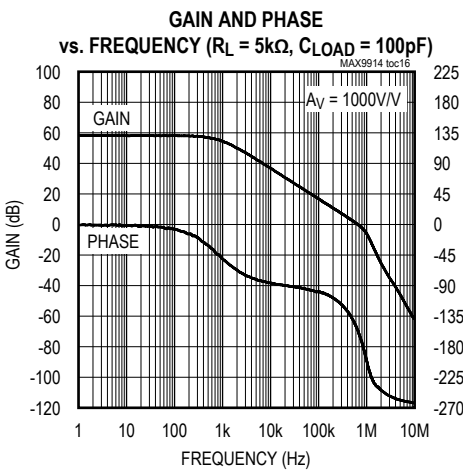
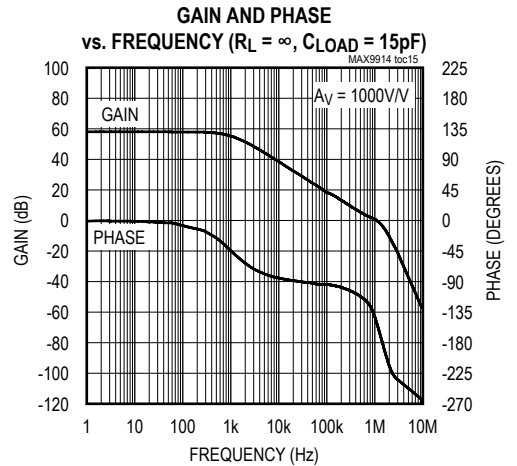
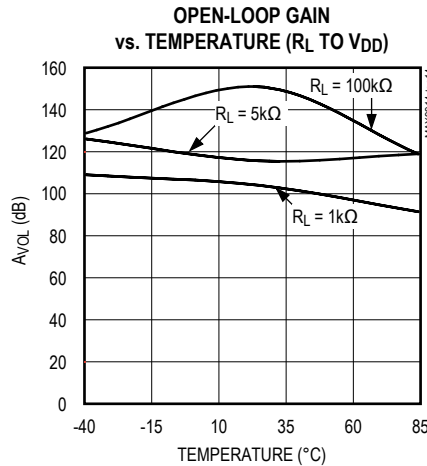
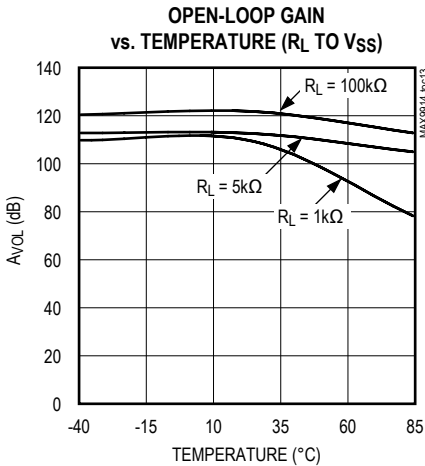
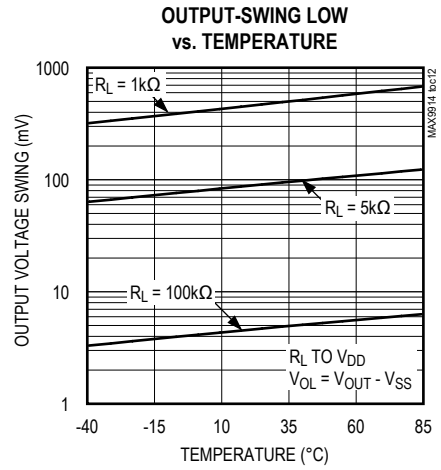
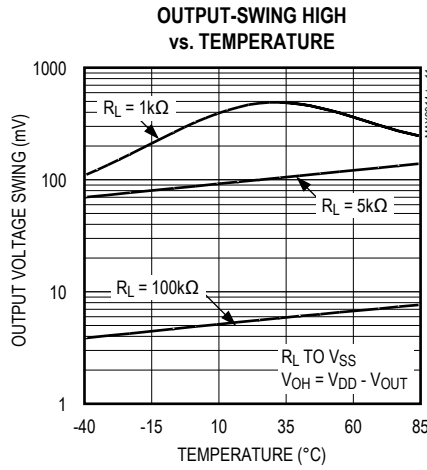
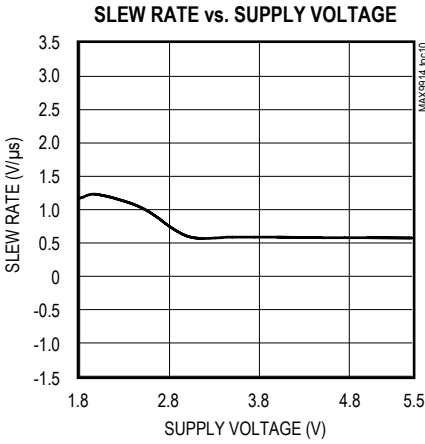

Typical Operating Characteristics (continued)

($V_{DD} = 3V$, $V_{SS} = V_{CM} = 0V$, R_L to $V_{DD}/2$, $T_A = +25^\circ C$, unless otherwise noted.)

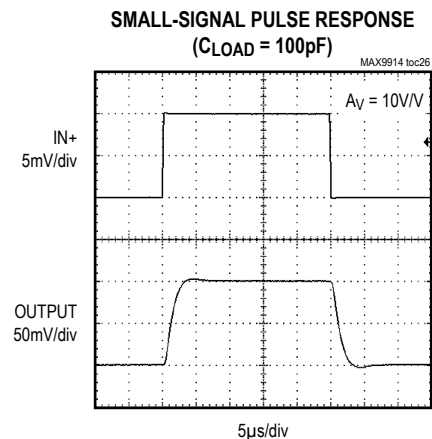
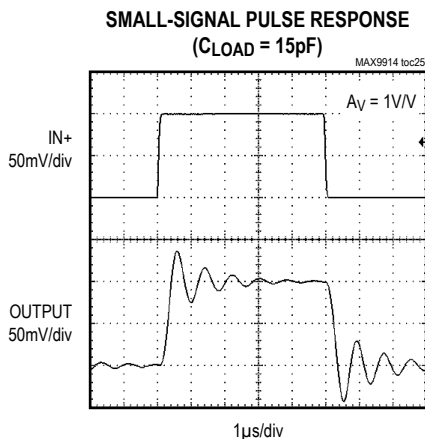
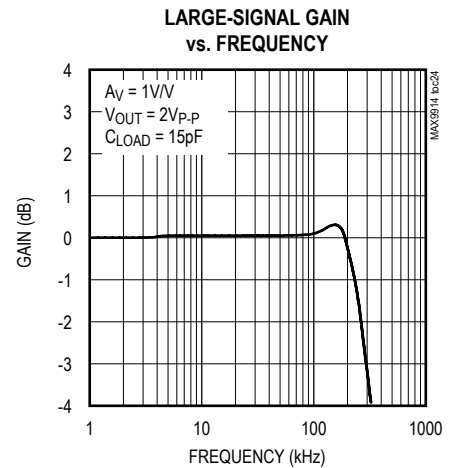
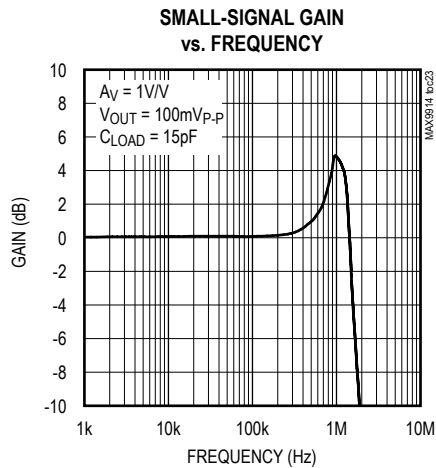
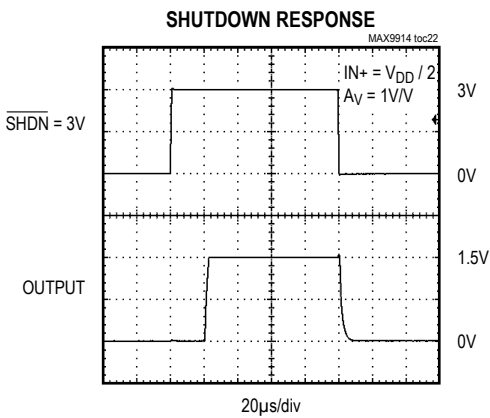
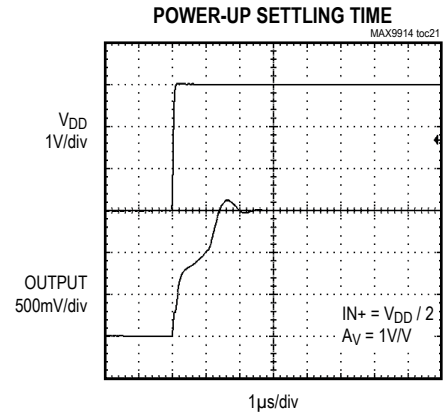
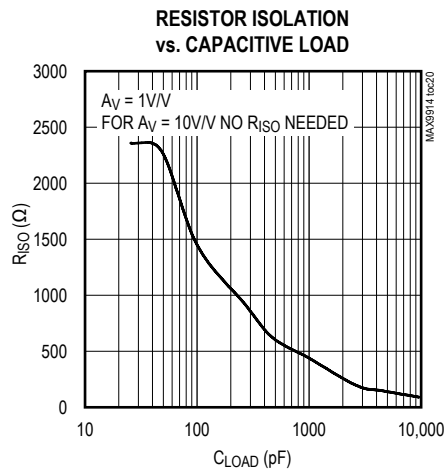
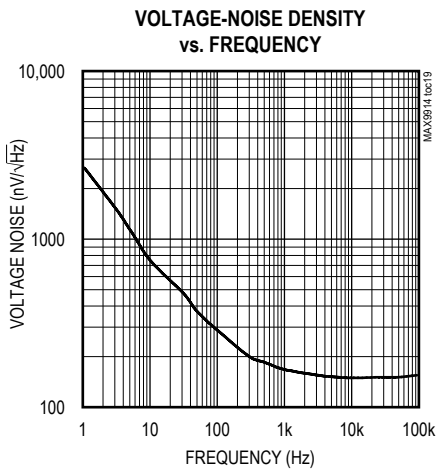

Typical Operating Characteristics (continued)

($V_{DD} = 3V$, $V_{SS} = V_{CM} = 0V$, R_L to $V_{DD}/2$, $T_A = +25^\circ C$, unless otherwise noted.)

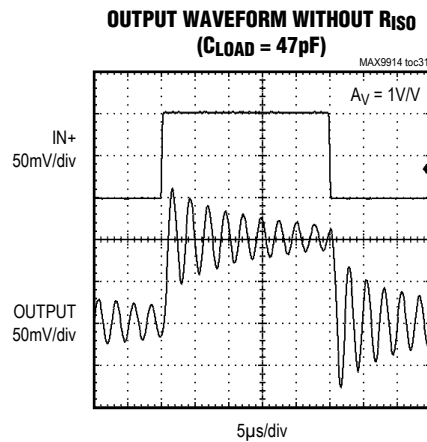
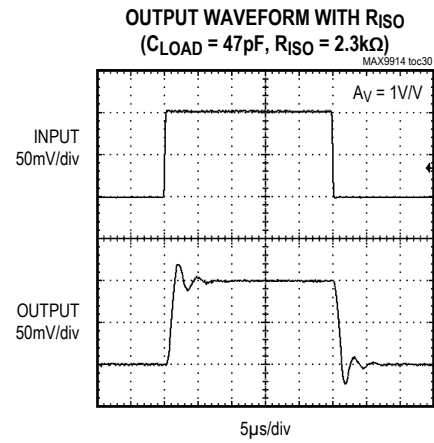
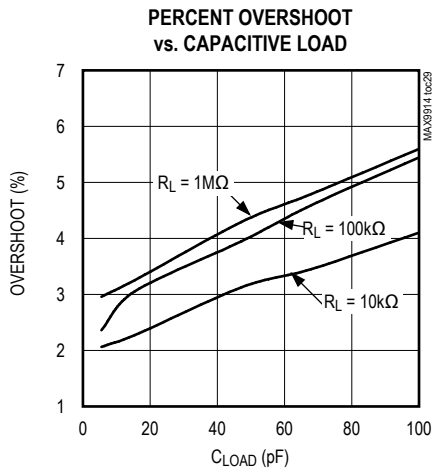
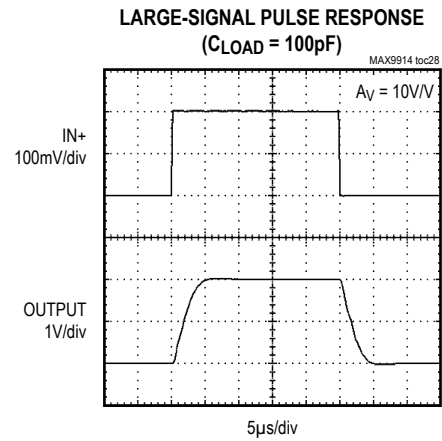
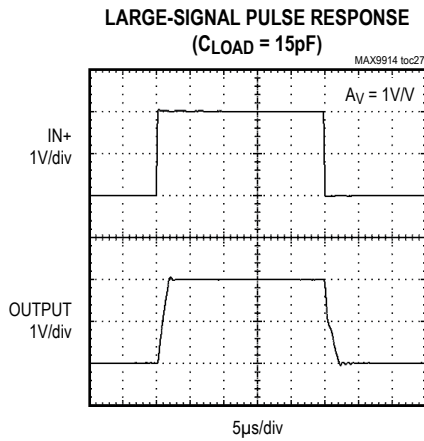

Pin Description

PIN				NAME	FUNCTION
MAX9914	MAX9915	MAX9916	MAX9917		
1	1	—	—	IN+	Noninverting Amplifier Input
2	2	4	4	V _{SS}	Negative Supply Voltage
3	3	—	—	IN-	Inverting Amplifier Input
4	4	—	—	OUT	Amplifier Output
5	6	8	10	V _{DD}	Positive Supply Voltage
—	5	—	—	$\overline{\text{SHDN}}$	Shutdown
—	—	1	1	OUTA	Amplifier Output Channel A
—	—	2	2	INA-	Inverting Amplifier Input Channel A
—	—	3	3	INA+	Noninverting Amplifier Input Channel A
—	—	—	5	$\overline{\text{SHDNA}}$	Shutdown Channel A
—	—	—	6	$\overline{\text{SHDNB}}$	Shutdown Channel B
—	—	5	7	INB+	Noninverting Amplifier Input Channel B
—	—	6	8	INB-	Inverting Amplifier Input Channel B
—	—	7	9	OUTB	Amplifier Output Channel B

Detailed Description

Featuring a maximized ratio of gain bandwidth to supply current, low operating supply voltage, low input bias current, and rail-to-rail inputs and outputs, the MAX9914–MAX9917 are an excellent choice for precision or general-purpose low-current, low-voltage, battery-powered applications. These CMOS devices consume an ultra-low 20 μ A (typ) supply current and a 200 μ V (typ) offset voltage. For additional power conservation, the MAX9914/MAX9917 feature a lowpower shutdown mode that reduces supply current to 1nA (typ), and puts the amplifiers' output in a highimpedance state. These devices are unity-gain stable with a 1MHz gain-bandwidth product driving capacitive loads up to 30pF. The capacitive load can be increased to 100pF when the amplifier is configured for a 10V/V gain.

Rail-to-Rail Inputs and Outputs

The MAX9914–MAX9917 amplifiers all have a parallel-connected n- and p-channel differential input stage that allows an input common-mode voltage range that extends 100mV beyond the positive and negative supply rails, with excellent common-mode rejection.

The MAX9914–MAX9917 are capable of driving the output to within 5mV of both supply rails with a 100k Ω load. These devices can drive a 5k Ω load with swings to within 60mV of the rails. Figure 1 shows no clipping at the output voltage swing of the MAX9914–MAX9917 configured as a unity-gain buffer powered from a single 3V supply.

Low Input Bias Current

The MAX9914–MAX9917 feature ultra-low 1pA (typ) input bias current. The variation in the input bias current is minimal with changes in the input voltage due to very high input impedance (in the order of 1G Ω).

Applications Information

Driving Capacitive Loads

The MAX9914–MAX9917 amplifiers are unity-gain stable for loads up to 30pF. However, the capacitive load can be increased to 100pF when the amplifier is configured for a minimum gain of 10V/V.

Applications that require greater capacitive drive capability should use an isolation resistor between the output and the capacitive load (Figure 2). Also, in unity-gain applications with relatively small R_L (about 5k Ω), the capacitive load can be increased up to 100pF.

Power-Supply Considerations

The MAX9914–MAX9917 are optimized for single 1.8V to 5.5V supply operation. A high amplifier power-supply rejection ratio of 85dB (typ) allows the devices to be powered directly from a battery, simplifying design and extending battery life.

Power-Up Settling Time

The MAX9914–MAX9917 typically require 2µs after power-up. Supply settling time depends on the supply voltage, the value of the bypass capacitor, the output impedance of the incoming supply, and any lead resistance or inductance between components. Op amp settling time depends primarily on the output voltage and is slew-rate limited. Figure 3 shows the MAX991_ in a noninverting voltage follower configuration with the input held at mid-supply. The output settles in approximately 3.5µs for V_{DD} = 3V (see the *Typical Operating Characteristics* for the Power-Up Settling Time graph).

Shutdown Mode

The MAX9915 and MAX9917 feature active-low shutdown inputs. The MAX9915 and MAX9917 enter shutdown in 2µs (typ) and exit shutdown in 10µs (typ). The amplifiers' outputs are high impedance in shutdown mode. Drive $\overline{\text{SHDN}}$ low to enter shutdown. Drive $\overline{\text{SHDN}}$ high to enable the amplifier. The MAX9917 dual amplifier features separate shutdown inputs. Shut down both amplifiers for lowest quiescent current.

Power-Supply Bypassing and Layout

Bypass V_{DD} with a 0.1µF capacitor to ground as close to the pin as possible to minimize noise.

Good layout techniques optimize performance by decreasing the amount of stray capacitance and inductance to the op amp's inputs and outputs. Minimize stray capacitance and inductance, by placing external components close to the IC.

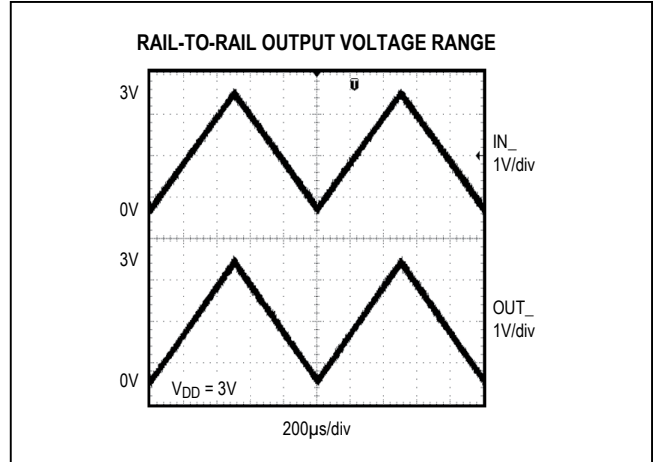

Figure 1. Rail-to-Rail Output Voltage Range

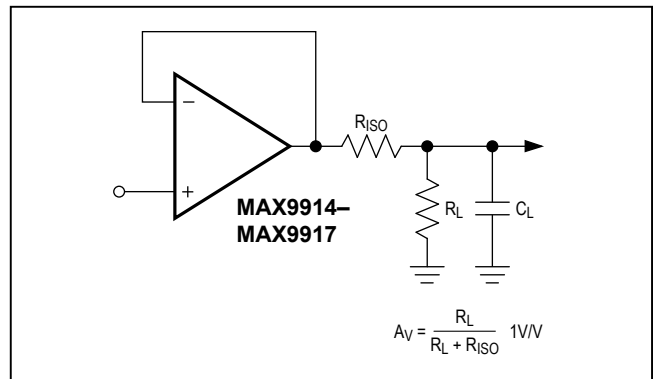

Figure 2. Using a Resistor to Isolate a Capacitive Load from the Op Amp

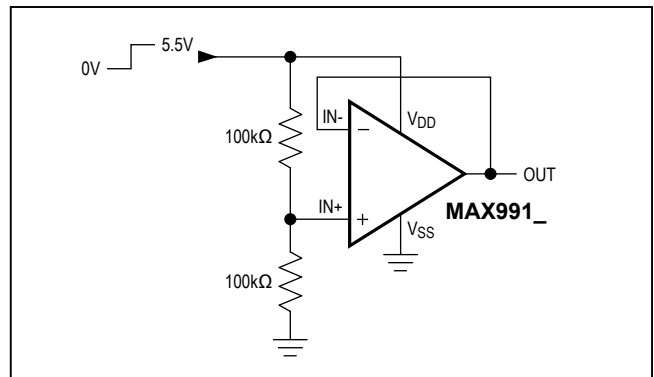
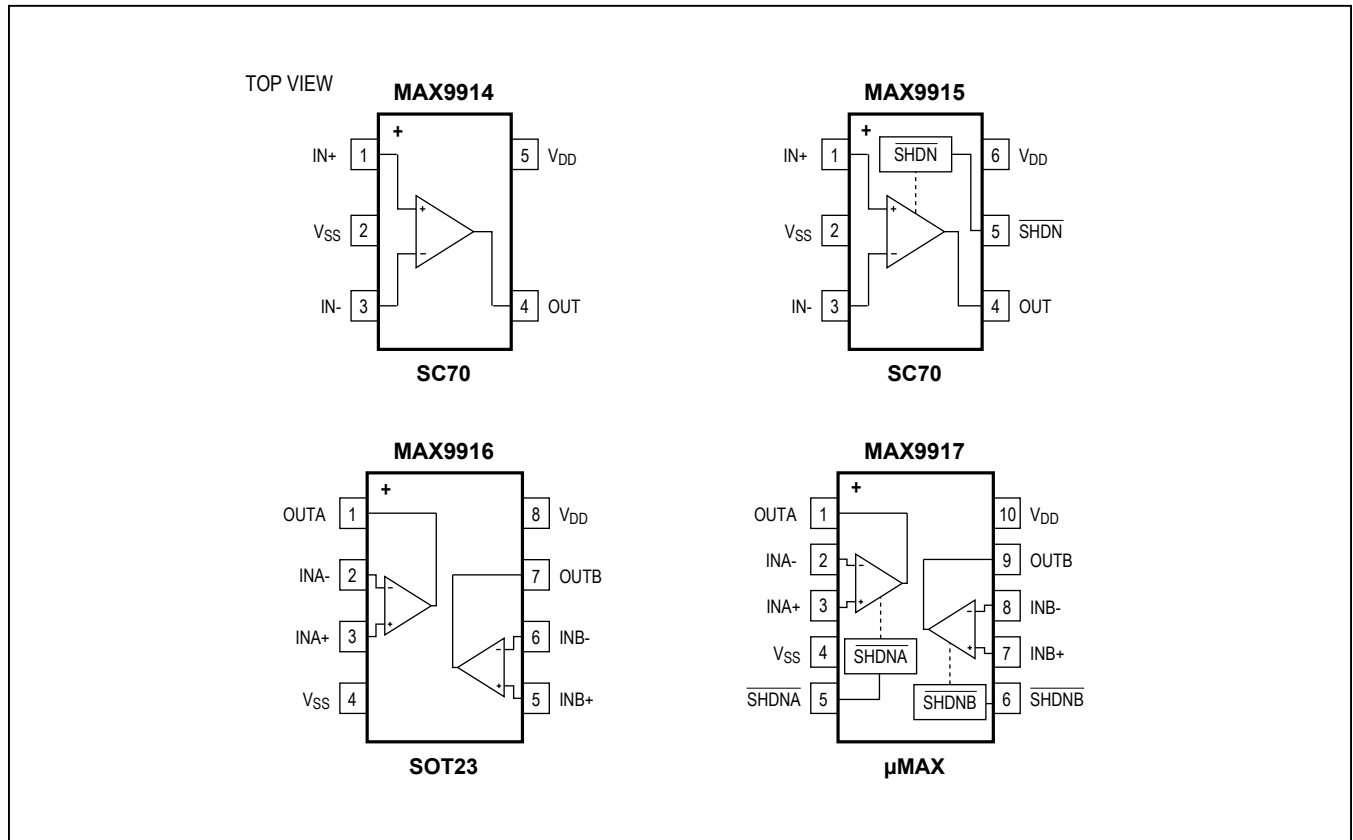

Figure 3. Power-Up Test Configuration

Pin Configurations



Chip Information

PROCESS: BiCMOS

Package Information

For the latest package outline information and land patterns (footprints), go to www.maximintegrated.com/packages. Note that a “+”, “#”, or “-” in the package code indicates RoHS status only. Package drawings may show a different suffix character, but the drawing pertains to the package regardless of RoHS status.

PACKAGE TYPE	PACKAGE CODE	OUTLINE NO.	LAND PATTERN NO.
5 SC70	X5+1	21-0076	90-0188
6 SC70	X6SN+1	21-0077	90-0189
8 SOT23	K8+5	21-0078	90-0176
10 µMAX	U10+2	21-0061	90-0330

Revision History

REVISION NUMBER	REVISION DATE	DESCRIPTION	PAGES CHANGED
0	11/04	Initial release	—
1	10/05	Removed future product asterisks from MAX9916/MAX9917, edited V_{OL} / V_{OH} specifications in the EC table, removed MAX9916 8-pin μ MAX package.	1, 2, 11
2	6/13	Updated <i>Electrical Characteristics</i>	3, 4
3	11/14	Updated <i>Absolute Maximum Ratings</i> and <i>Electrical Characteristics</i>	2, 3, 4

For pricing, delivery, and ordering information, please contact Maxim Direct at 1-888-629-4642, or visit Maxim Integrated's website at www.maximintegrated.com.

Maxim Integrated cannot assume responsibility for use of any circuitry other than circuitry entirely embodied in a Maxim Integrated product. No circuit patent licenses are implied. Maxim Integrated reserves the right to change the circuitry and specifications without notice at any time. The parametric values (min and max limits) shown in the *Electrical Characteristics* table are guaranteed. Other parametric values quoted in this data sheet are provided for guidance.

Компания «Океан Электроники» предлагает заключение долгосрочных отношений при поставках импортных электронных компонентов на взаимовыгодных условиях!

Наши преимущества:

- Поставка оригинальных импортных электронных компонентов напрямую с производств Америки, Европы и Азии, а так же с крупнейших складов мира;
- Широкая линейка поставок активных и пассивных импортных электронных компонентов (более 30 млн. наименований);
- Поставка сложных, дефицитных, либо снятых с производства позиций;
- Оперативные сроки поставки под заказ (от 5 рабочих дней);
- Экспресс доставка в любую точку России;
- Помощь Конструкторского Отдела и консультации квалифицированных инженеров;
- Техническая поддержка проекта, помощь в подборе аналогов, поставка прототипов;
- Поставка электронных компонентов под контролем ВП;
- Система менеджмента качества сертифицирована по Международному стандарту ISO 9001;
- При необходимости вся продукция военного и аэрокосмического назначения проходит испытания и сертификацию в лаборатории (по согласованию с заказчиком);
- Поставка специализированных компонентов военного и аэрокосмического уровня качества (Xilinx, Altera, Analog Devices, Intersil, Interpoint, Microsemi, Actel, Aeroflex, Peregrine, VPT, Syfer, Eurofarad, Texas Instruments, MS Kennedy, Miteq, Cobham, E2V, MA-COM, Hittite, Mini-Circuits, General Dynamics и др.);

Компания «Океан Электроники» является официальным дистрибьютором и эксклюзивным представителем в России одного из крупнейших производителей разъемов военного и аэрокосмического назначения «JONHON», а так же официальным дистрибьютором и эксклюзивным представителем в России производителя высокотехнологичных и надежных решений для передачи СВЧ сигналов «FORSTAR».



JONHON

«JONHON» (основан в 1970 г.)

Разъемы специального, военного и аэрокосмического назначения:

(Применяются в военной, авиационной, аэрокосмической, морской, железнодорожной, горно- и нефтедобывающей отраслях промышленности)

«FORSTAR» (основан в 1998 г.)

ВЧ соединители, коаксиальные кабели, кабельные сборки и микроволновые компоненты:

(Применяются в телекоммуникациях гражданского и специального назначения, в средствах связи, РЛС, а так же военной, авиационной и аэрокосмической отраслях промышленности).



Телефон: 8 (812) 309-75-97 (многоканальный)

Факс: 8 (812) 320-03-32

Электронная почта: ocean@oceanchips.ru

Web: <http://oceanchips.ru/>

Адрес: 198099, г. Санкт-Петербург, ул. Калинина, д. 2, корп. 4, лит. А