

Description

The 74FCT3807S is a low skew, single input to ten output, clock buffer. The 74FCT3807S has best in class additive phase Jitter of sub 50 fsec.

IDT makes many non-PLL and PLL based low skew output devices as well as Zero Delay Buffers to synchronize clocks. Contact us for all of your clocking needs.

Features

- Low additive phase jitter RMS: 50fs
- Low skew outputs (50ps)
- Packaged in 20-pin TSSOP, SSOP, QSOP and VFQFPN packages, Pb (lead) free
- Operating voltages of 1.8V to 3.3V
- Input/Output clock frequency up to 200 MHz
- Advanced, low power CMOS process
- Extended temperature range (-40°C to +105°C)

Block Diagram



Pin Assignments



20-pin TSSOP/SSOP/QSOP

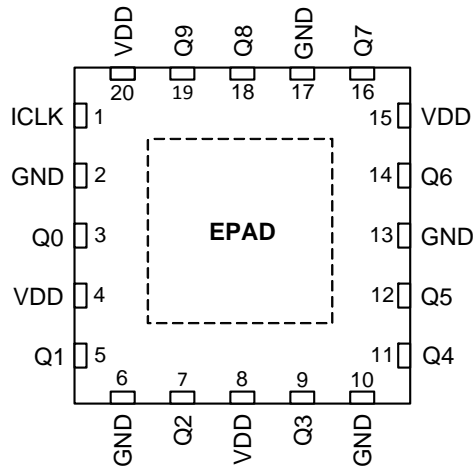

20-pin VFQFPN

Pin Descriptions

Pin Number	Pin Name	Pin Type	Pin Description
1	ICLK	Input	Clock input.
2	GND	Power	Connect to ground.
3	Q0	Output	Clock output 0.
4	VDD	Power	Connect to +1.8V, +2.5 V, or +3.3 V.
5	Q1	Output	Clock output 1.
6	GND	Power	Connect to ground.
7	Q2	Output	Clock Output 2.
8	VDD	Power	Connect to +1.8V, +2.5 V, or +3.3 V.
9	Q3	Output	Clock Output 3.
10	GND	Power	Connect to ground.
11	Q4	Output	Clock Output 4.
12	Q5	Output	Clock Output 5.
13	GND	Power	Connect to ground.
14	Q6	Output	Clock Output 6.
15	VDD	Power	Connect to +1.8V, +2.5 V, or +3.3 V.
16	Q7	Output	Clock Output 7.
17	GND	Power	Connect to ground.
18	Q8	Output	Clock Output 8.
19	Q9	Output	Clock Output 9.
20	VDD	Power	Connect to +1.8V, +2.5 V, or +3.3 V.

External Components

A minimum number of external components are required for proper operation. A decoupling capacitor of 0.01 μ F should be connected between VDD pins and GND pins, as close to the device as possible. A 33 Ω series terminating resistor may be used on each clock output if the trace is longer than 1 inch.

To achieve the low output skew that the 74FCT3807S is capable of, careful attention must be paid to board layout. Essentially, all ten outputs must have identical terminations, identical loads and identical trace geometries. If they do not, the output skew will be degraded. For example, using a 30 Ω series termination on one output (with 33 Ω on the others) will cause at least 15 ps of skew.

Absolute Maximum Ratings

Stresses above the ratings listed below can cause permanent damage to the 74FCT3807S. These ratings, which are standard values for IDT commercially rated parts, are stress ratings only. Functional operation of the device at these or any other conditions above those indicated in the operational sections of the specifications is not implied. Exposure to absolute maximum rating conditions for extended periods can affect product reliability. Electrical parameters are guaranteed only over the recommended operating temperature range.

Item	Rating
Supply Voltage, VDD	3.465V
Outputs	-0.5 V to VDD+0.5 V
ICLK	3.465V
Ambient Operating Temperature (extended)	-40° to +105°C
Storage Temperature	-65° to +150°C
Junction Temperature	125°C
Soldering Temperature	260°C

Recommended Operation Conditions

Parameter	Min.	Typ.	Max.	Units
Ambient Operating Temperature (extended)	-40		+105	°C
Power Supply Voltage (measured in respect to GND)	+1.71		+3.465	V

DC Electrical Characteristics

(VDD = 1.8V, 2.5V, 3.3V)

VDD=1.8V ±5% , Ambient temperature -40° to +105°C, unless stated otherwise

Parameter	Symbol	Conditions	Min.	Typ.	Max.	Units
Operating Voltage	VDD		1.71		1.89	V
Input High Voltage, ICLK	V _{IH}	Note 1	0.7xVDD		VDD	V
Input Low Voltage, ICLK	V _{IL}	Note 1			0.3xVDD	V
Output High Voltage	V _{OH}	I _{OH} = -10 mA	1.3			V
Output Low Voltage	V _{OL}	I _{OL} = 10 mA			0.35	V
Operating Supply Current	IDD	No load, 135 MHz		35		mA
Nominal Output Impedance	Z _O			17		Ω
Input Capacitance	C _{IN}	ICLK		5		pF

Notes: 1. Nominal switching threshold is VDD/2

VDD=2.5 V ±5%, Ambient temperature -40° to +105°C, unless stated otherwise

Parameter	Symbol	Conditions	Min.	Typ.	Max.	Units
Operating Voltage	VDD		2.375		2.625	V
Input High Voltage, ICLK	V _{IH}	Note 1	0.7xVDD		VDD	V
Input Low Voltage, ICLK	V _{IL}	Note 1			0.3xVDD	V
Output High Voltage	V _{OH}	I _{OH} = -16 mA	1.8			V
Output Low Voltage	V _{OL}	I _{OL} = 16 mA			0.5	V
Operating Supply Current	IDD	No load, 135 MHz		45		mA
Nominal Output Impedance	Z _O			17		Ω
Input Capacitance	C _{IN}	ICLK		5		pF

VDD=3.3 V ±5% , Ambient temperature -40° to +105°C, unless stated otherwise

Parameter	Symbol	Conditions	Min.	Typ.	Max.	Units
Operating Voltage	VDD		3.15		3.45	V
Input High Voltage, ICLK	V _{IH}	Note 1	0.7xVDD		VDD	V
Input Low Voltage, ICLK	V _{IL}	Note 1			0.3xVDD	V
Output High Voltage	V _{OH}	I _{OH} = -25 mA	2.2			V
Output Low Voltage	V _{OL}	I _{OL} = 25 mA			0.7	V
Operating Supply Current	IDD	No load, 135 MHz		55		mA
Nominal Output Impedance	Z _O			17		Ω
Input Capacitance	C _{IN}	ICLK		5		pF

AC Electrical Characteristics

(VDD = 1.8V, 2.5V, 3.3V)

VDD = 1.8V ±5%, Ambient Temperature -40° to +105°C, unless stated otherwise

Parameter	Symbol	Conditions	Min.	Typ.	Max.	Units
Input Frequency			0		200	MHz
Output Rise Time	t _{OR}	0.36 to 1.44 V, C _L =5 pF		1.4	1.9	ns
Output Fall Time	t _{OF}	1.44 to 0.36 V, C _L =5 pF		1.4	1.9	ns
Propagation Delay		Note 1	1.5	2.5	4	ns
Buffer Additive Phase Jitter, RMS		125MHz, Integration Range: 12kHz-20MHz			0.05	ps
Output to Output Skew		Rising edges at VDD/2, Note 2		50	65	ps
Device to Device Skew		Rising edges at VDD/2			200	ps
Start-up Time	t _{START-UP}	Part start-up time for valid outputs after VDD ramp-up			2	ms

VDD = 2.5 V ±5%, Ambient Temperature -40° to +105°C, unless stated otherwise

Parameter	Symbol	Conditions	Min.	Typ.	Max.	Units
Input Frequency			0		200	MHz
Output Rise Time	t _{OR}	0.5 to 2.0 V, C _L =5 pF		1.0	1.5	ns
Output Fall Time	t _{OF}	2.0 to 0.5 V, C _L =5 pF		1.0	1.5	ns
Propagation Delay		Note 1	1.8	2.5	4.5	ns
Buffer Additive Phase Jitter, RMS		125MHz, Integration Range: 12kHz-20MHz			0.05	ps
Output to Output Skew		Rising edges at VDD/2, Note 2		50	65	ps
Device to Device Skew		Rising edges at VDD/2			200	ps
Start-up Time	t _{START-UP}	Part start-up time for valid outputs after VDD ramp-up			2	ms

VDD = 3.3 V ±5%, Ambient Temperature -40° to +105°C, unless stated otherwise

Parameter	Symbol	Conditions	Min.	Typ.	Max.	Units
Input Frequency			0		200	MHz
Output Rise Time	t _{OR}	0.66 to 2.64 V, C _L =5 pF		0.6	1.0	ns
Output Fall Time	t _{OF}	2.64 to 0.66 V, C _L =5 pF		0.6	1.0	ns
Propagation Delay		Note 1	1.5	2.5	4	ns
Buffer Additive Phase Jitter, RMS		125MHz, Integration Range: 12kHz-20MHz			0.05	ps
Output to Output Skew		Rising edges at VDD/2, Note 2		50	65	ps
Device to Device Skew		Rising edges at VDD/2			200	ps
Start-up Time	t _{START-UP}	Part start-up time for valid outputs after VDD ramp-up			2	ms

Notes:

1. With rail to rail input clock
2. Between any 2 outputs with equal loading.
3. Duty cycle on outputs will match incoming clock duty cycle. Consult IDT for tight duty cycle clock generators.

Test Load and Circuit



Marking Diagrams



Notes:

1. "LOT" denotes the lot number.
2. "XXX" denotes the lot number.
3. "YYWW" or "YWW" are the last digits of the year and week that the part was assembled.
4. "\$" denotes mark code.
5. "I" denotes extended temperature range device.
6. "AAA" denotes package code.

Package Outline and Package Dimensions (20-pin VFQFPN)

- NOTE :
1. ALL DIMENSIONS ARE IN mm. ANGLES IN DEGREES.
 2. COPLANARITY APPLIES TO THE EXPOSED PAD AS WELL AS THE TERMINALS.
 3. WARPAGE SHALL NOT EXCEED 0.05 mm.
 4. PACKAGE LENGTH / PACKAGE WIDTH ARE CONSIDERED AS SPECIAL CHARACTERISTIC. (S)
 5. REFER JEDEC MO-220.

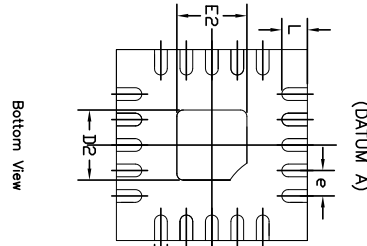
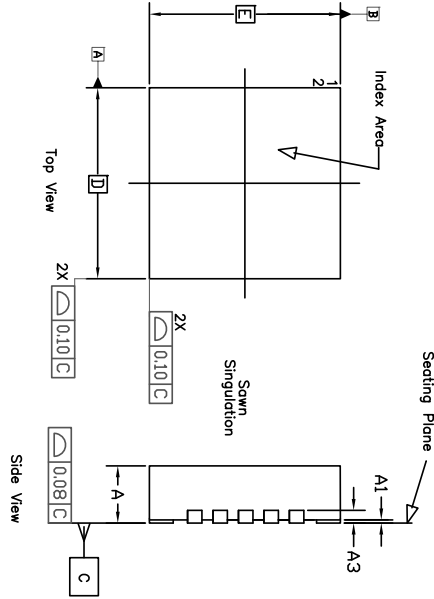

COMMON DIMENSION

Symbol	DIMENSION		
	Min	Nom	Max
A	0.80	0.90	1.00
A1	0	0.02	0.05
A3	0.20 Ref		
b	0.17	0.20	0.25
e	0.40 BASIC		
N	20		
ND	5		
NE	5		
D	3.00 BASIC		
E	3.00 BASIC		
D2	SEE EPAD OPTION		
E2	SEE EPAD OPTION		
L	0.30	0.40	0.50

REVISIONS			
REV	DESCRIPTION	DATE	APPROVED
00	INITIAL RELEASE	11/14/08	RC
01	ADD EPAD OPTION	11/28/12	RC
02	COMBINE PAD & LAND PATTERN	12/5/13	JHUA
03	Change Dimension aaa	7/14/14	JHUA

Symbol	P1			P2		
	MIN	NOM	MAX	MIN	NOM	MAX
E2	0.95	1.10	1.25	1.55	1.65	1.75
D2	0.95	1.10	1.25	1.55	1.65	1.75

TOLERANCES UNLESS SPECIFIED DECIMAL ANGULAR XXX+ E11 XXX+		6024 Silver Creek Valley Road San Jose CA 95138 PHONE: (408) 284-8200 WWW.IDT.COM FAX: (408) 284-8991
APPROVALS DRAWN RAG CHECKED	DATE 11/14/08	
TITLE ND/NDG 20 PACKAGE OUTLINE 3.0 x 3.0 mm BODY, 0.40 PITCH OFN		SIZE DRAWING No. C PSC-4179
DO NOT SCALE DRAWING		REV 03

Package Outline and Package Dimensions, cont. (20-pin VFQFPN)



EPAD 1.1 mm SQ



EPAD 1.65 mm SQ

RECOMMENDED LAND PATTERN DIMENSION

- NOTES:
1. ALL DIMENSION ARE IN mm, ANGLES IN DEGREES.
 2. TOP DOWN VIEW, AS VIEWED ON PCB.
 3. COMPONENT OUTLINE SHOW FOR REFERENCE IN GREEN.
 4. LAND PATTERN IN BLUE, NSMD PATTERN ASSUMED.
 5. LAND PATTERN RECOMMENDATION PER IPC-7351B GENERIC REQUIREMENT FOR SURFACE MOUNT DESIGN AND LAND PATTERN.

REVISIONS			
REV	DESCRIPTION	DATE	APPROVED
00	INITIAL RELEASE	11/14/08	RC
01	ADD EPAD OPTION	11/28/12	RC
02	COMBINE POD & LAND PATTERN	12/5/13	J.HUA
03	Change dimension ooo	7/14/14	J.HUA

TOLERANCES UNLESS SPECIFIED DECIMAL ANGULAR ±0.1°		8024 Silver Creek Valley Road San Jose CA 95138 PHONE: (408) 284-8200 FAX: (408) 294-8591 WWW.IDT.COM
APPROVALS DRAWN: <i>RLG</i> CHECKED:	DATE: 11/14/08 TITLE: ND/NDG 20 PACKAGE OUTLINE 3.0 x 3.0 mm BODY, 0.40 PITCH QFN	
SIZE: C DRAWING No.: PSC-4179 DO NOT SCALE DRAWING	REV: 03 SHEET 2 OF 2	

Package Outline and Package Dimensions (20-pin TSSOP)

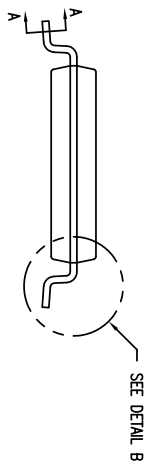
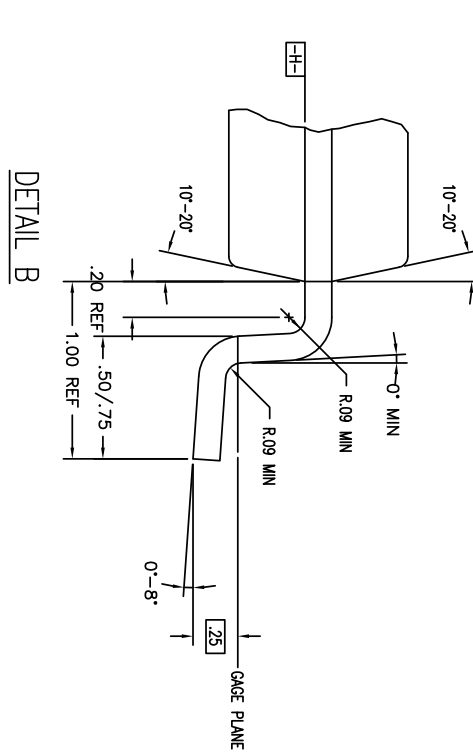
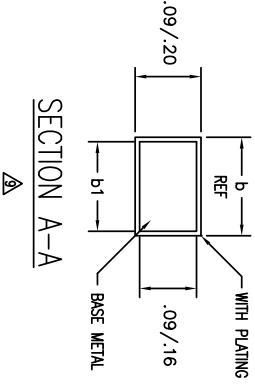

REVISIONS			
REV	DESCRIPTION	DATE	APPROVE
02	ADD 14 & 16 LD	08/29/98	T. VU
03	ADD 8 LD	07/10/99	T. VU
04	ADDED TOPMARK TO TITLE	5/23/01	TU VU
05	ADD "GREEN" PFG NOMENCLATURE	10/14/04	TU VU
06	ADDED PACKAGE CODE	3/8/13	RAC

TOLERANCES UNLESS SPECIFIED		www.IDT.com	
DECIMAL	ANGULAR	2975 Stander Way	
±	±	Santa Clara, CA 95054	
XXXX±		PHONE: (408) 727-6116	
XXXX±		FAX: (408) 492-8674	
APPROVALS	DATE	TITLE	
DRWN 379	01/15/96	PG/PFG PACKAGE OUTLINE	
CHECKED		(PG OR PA TOPMARK CODE)	
		4.4 mm BODY WIDTH TSSOP .65 mm PITCH	
SIZE	DRAWING NO.	PSC-4056	
C			
DO NOT SCALE DRAWING			
SHEET 1 OF			RE

Package Outline and Package Dimensions, cont. (20-pin TSSOP)

NOTES:

- 1 ALL DIMENSIONING AND TOLERANCING CONFORM TO ASME Y14.5M-1994
- ▲ DATUMS **-A-** AND **-B-** TO BE DETERMINED AT DATUM PLANE **-H-**
- ▲ DIMENSION E TO BE DETERMINED AT SEATING PLANE **-C-**
- ▲ DIMENSIONS D AND E1 ARE TO BE DETERMINED AT DATUM PLANE **-H-**
- ▲ DIMENSION D DOES NOT INCLUDE MOLD FLASH, PROTRUSIONS OR GATE BURRS. MOLD FLASH, PROTRUSIONS OR GATE BURRS SHALL NOT EXCEED .15 mm PER SIDE
- ▲ DIMENSION E1 DOES NOT INCLUDE INTERLEAD FLASH OR PROTRUSIONS. INTERLEAD FLASH OR PROTRUSIONS SHALL NOT EXCEED .25 mm PER SIDE
- ▲ DETAIL OF PIN 1 IDENTIFIER IS OPTIONAL BUT MUST BE LOCATED WITHIN THE ZONE INDICATED
- ▲ LEAD WIDTH DIMENSION DOES NOT INCLUDE DAMBAR PROTRUSION. ALLOWABLE DAMBAR PROTRUSION IS .08 mm IN EXCESS OF THE LEAD WIDTH DIMENSION AT MAXIMUM MATERIAL CONDITION. DAMBAR CANNOT BE LOCATED ON THE LOWER RADIUS OR THE FOOT
- ▲ THESE DIMENSIONS APPLY TO THE FLAT SECTION OF THE LEAD BETWEEN .10 AND .25 mm FROM THE LEAD TIP
- 10 ALL DIMENSIONS ARE IN MILLIMETERS
- 11 THIS OUTLINE CONFORMS TO JEDEC PUBLICATION 95 REGISTRATION MO-153, VARIATION AA, AB-1, AB, AC, AD & AE

PG/PG620			
JEDEC VARIATION			N O T E
AC	NOM	MAX	
MIN	—	1.20	
—	—	.15	
.05	—	—	
.80	1.00	1.05	
6.40	6.50	6.60	4.5
6.40 BSC			3
4.30	4.40	4.50	4.6
.65 BSC			
.19	—	.30	
.19	.22	.25	
—	—	.10	
—	—	.10	
20			

REVISIONS			
REV	DESCRIPTION	DATE	APPROVED
02	ADD 14 & 16 LD	08/25/98	T. VU
03	ADD 8 LD	07/10/99	T. VU
04	ADDED TOPMARK TO TITLE	5/23/01	TU VU
05	ADD "GREEN" PGG NOMENCLATURE	10/14/04	TU VU
06	ADDED PACKAGE CODE	3/8/13	RAC

TOLERANCES UNLESS SPECIFIED			2975 Stender Way Santa Clara, CA 95054 PHONE: (408) 727-6116 FAX: (408) 492-8674
DECIMAL	±		
ANGULAR	±		
DATE	DATE		
APPROVALS	TITLE	PG/PG6 PACKAGE OUTLINE	
DRAWN 979	(PG OR PA TOPMARK CODE)	4.4 mm BODY WIDTH TSSOP .65 mm PITCH	
CHECKED	SIZE	DRAWING No. PSC-4056	
	DO NOT SCALE DRAWING	REV 06	
		SHEET 2 OF 3	

Package Outline and Package Dimensions, cont. (20-pin TSSOP)

LAND PATTERN DIMENSIONS

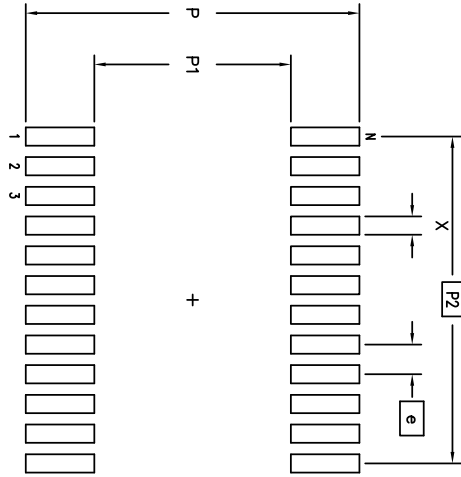

	MIN	MAX
	7.20	7.40
	4.20	4.40
	5.85 BSC	
	.30	.50
	.65 BSC	
	20	

REVISIONS			
REV	DESCRIPTION	DATE	APPROVED
02	ADD 14 & 16 LD	08/29/98	T. YU
03	ADD 8 LD	07/10/99	T. YU
04	ADDED TOPMARK TO TITLE	5/23/01	TU YU
05	ADD "GREEN" PGG NOMENCLATURE	10/14/04	TU YU
06	ADDED PACKAGE CODE	3/8/13	RAC

TOLERANCES	
UNLESS SPECIFIED	ANGULAR
DECIMAL	±
XXX.X	
XXXX.X	
XXXXX.X	

APPROVALS	DATE	TITLE
DRAWN: JY	01/15/98	PG/PGG PACKAGE OUTLINE (PG OR PA TOPMARK CODE)
CHECKED:		4.4 mm BODY WIDTH TSSOP .65 mm PITCH
SIZE	C	PSC-4056
REV	06	

DO NOT SCALE DRAWING	SHEET 3 OF 3
----------------------	--------------

Package Outline and Package Dimensions (20-pin QSOP)

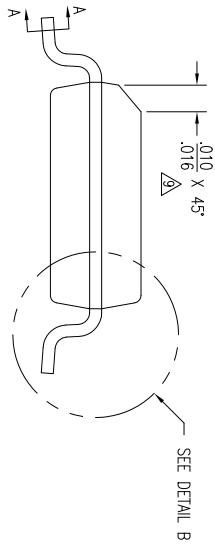

REVISIONS			
REV	DESCRIPTION	DATE	APPROV
01	REDRAW TO JEDEC FORMAT	03/10/95	T. VU
02	ADD 28 LD	08/15/95	T. VU
03	CHANGE TO QSOP	12/15/99	S.SUE
04	ADD "GREEN" POG NOMENCLATURE	10/08/04	TU VU
05	CHANGE RADIUS DIM	11/15/11	OK LEE

TOLERANCES UNLESS SPECIFIED			2975 Slender Way Santa Clara, CA 95050 PHONE: (408) 727-6100 FAX: (408) 492-8674
DECIMAL	±		
ANGULAR	±	www.IDT.com	
APPROVALS	DATE	TITLE PC/PCG PACKAGE OUTLINE	
DRAWN		.150" BODY WIDTH QSOP	
CHECKED		.025" PITCH	
SIZE	DRAWING No.	PSC-4040	
C		DO NOT SCALE DRAWING	
R		SHEET 1 OF 1	

Package Outline and Package Dimensions, cont. (20-pin QSOP)

JEDEC VARIATION			N D T E
AD			
MIN	NOM	MAX	
.061	.064	.068	
.004	.006	.010	
.055	.058	.061	11
.337	.342	.344	4,5
.230	.236	.244	3
.150	.155	.157	4,6
20			

NOTES:

- 1 ALL DIMENSIONING AND TOLERANCING CONFORM TO ANSI Y14.5M-1982
- ▷ DATUMS **-A-** AND **-B-** TO BE DETERMINED AT DATUM PLANE **-H-**
- ▷ DIMENSION E TO BE DETERMINED AT SEATING PLANE **-C-**
- ▷ DIMENSIONS D AND E1 ARE TO BE DETERMINED AT DATUM PLANE **-H-**
- ▷ DIMENSION D DOES NOT INCLUDE MOLD FLASH, PROTRUSIONS OR GATE BURRS; MOLD FLASH, PROTRUSIONS AND GATE BURRS SHALL NOT EXCEED .006 PER SIDE
- ▷ DIMENSION E1 DOES NOT INCLUDE INTERLEAD FLASH OR PROTRUSIONS; INTERLEAD FLASH OR PROTRUSIONS SHALL NOT EXCEED .010 PER SIDE
- ▷ THESE DIMENSIONS APPLY TO THE FLAT SECTION OF THE LEAD BETWEEN .005 AND .010 FROM LEAD TIP
- ▷ LEAD WIDTH DIMENSION DOES NOT INCLUDE DAMBAR PROTRUSION; ALLOWABLE DAMBAR PROTRUSION IS .004 IN EXCESS OF THE LEAD WIDTH DIMENSION AT MAXIMUM MATERIAL CONDITION. DAMBAR CANNOT BE LOCATED ON THE LOWER RADIUS OR THE FOOT
- ▷ THE CHAMFER ON THE PACKAGE BODY IS OPTIONAL. IF IT IS NOT PRESENT, A VISUAL INDEX FEATURE MUST BE LOCATED WITHIN THE ZONE INDICATED
- 10 ALL DIMENSIONS ARE IN INCHES
- 11 THIS OUTLINE CONFORMS TO JEDEC PUBLICATION 95 REGISTRATION MO-137, VARIATION AB, AD, AE & AF. EXCEPTIONS: JEDEC DIMENSION A2 MAX IS .059

REVISIONS			
DCN	REV	DESCRIPTION	DATE
28047	02	ADD 28 LD	08/15/95
	03	CHANGE TO QSOP	12/15/99
	04	ADD "GREEN" PGC NOMENCLATURE	10/08/04
	05	CHANGE RADIUS DIM	11/15/11
			CK LEE

LAND PATTERN DIMENSIONS



MIN	MAX
.274	.282
.142	.150
.225 BSC	
.010	.018
.025 BSC	
20	

TOLERANCES UNLESS SPECIFIED			
DECIMAL	ANGULAR	2975 Steiner Way Santa Clara, CA 95054 PHONE: (408) 727-6116 FAX: (408) 492-8674	
XXX±	±	www.IDT.com	
XXXX±			
APPROVALS	DATE	TITLE	
DRAWN		PC/PGC PACKAGE OUTLINE	
CHECKED		.150" BODY WIDTH QSOP	
		.025" PITCH	
		SIZE	REV
		C	05
		DRAWING No.	
		PSC-4040	
		DO NOT SCALE DRAWING	SHEET 2 OF 2

Package Outline and Package Dimensions (20-pin SSOP)

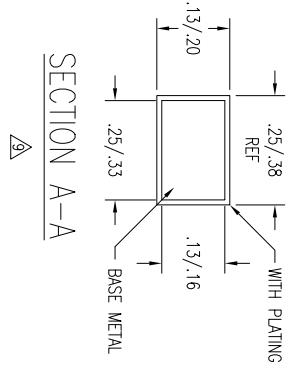

02	REDRAW TO JEDEC FORMAT	03/15/95	T. VU
03	ADD 14 & 16 LD	08/25/98	T. VU
04	ADDED TOPMARK TO TITLE	5/23/01	T. VU
05	ADD "GREEN" PYG NOMENCLATURE	10/12/04	TU VU
06	ADDED PACKAGE CODE	12/12/12	RC

TOLERANCES UNLESS SPECIFIED			6024 SILVERCREEK VALLEY F SAN JOSE CA 95138 PHONE: (408) 284-8200 FAX: (408) 294-8591
DECIMAL	ANGULAR		
XX±	±	www.IDT.com	
XXXX±		TITLE: PY/PYG PACKAGE OUTLINE (PY OR PV TOPMARK CODE) 5.3 mm BODY WIDTH SSOP .65 mm PITCH	
APPROVALS	DATE	SIZE	DRAWING No.
CHECKED		C	PSC-4032
		REV	06

Package Outline and Package Dimensions, cont. (20-pin SSOP)

PY/PVCG20				N O T E
JEDEC VARIATION				
AE				
MIN	NOM	MAX		
1.73	1.86	1.99		
.05	.13	.21		
1.68	1.73	1.78		
7.07	7.20	7.33	4,5	
7.65	7.80	7.90	3	
5.20	5.30	5.38	4,6	
20				

NOTES:

- 1 ALL DIMENSIONING AND TOLERANCING CONFORM TO ASME Y14.5M-1994
- 2 DATUMS **-A-** AND **-B-** TO BE DETERMINED AT DATUM PLANE **-H-**
- 3 DIMENSION E TO BE DETERMINED AT SEATING PLANE **-C-**
- 4 DIMENSIONS D AND E1 ARE TO BE DETERMINED AT DATUM PLANE **-H-**
- 5 DIMENSION D DOES NOT INCLUDE MOLD FLASH, PROTRUSIONS OR GATE BURRS. MOLD FLASH, PROTRUSIONS OR GATE BURRS SHALL NOT EXCEED .20 mm PER SIDE
- 6 DIMENSION E1 DOES NOT INCLUDE INTERLEAD FLASH OR PROTRUSIONS. INTERLEAD FLASH OR PROTRUSIONS SHALL NOT EXCEED .20 mm PER SIDE
- 7 DETAIL OF PIN 1 IDENTIFIER IS OPTIONAL BUT MUST BE LOCATED WITHIN THE ZONE INDICATED
- 8 LEAD WIDTH DIMENSION DOES NOT INCLUDE DAMBAR PROTRUSION. ALLOWABLE DAMBAR PROTRUSION IS .13 mm IN EXCESS OF THE LEAD WIDTH DIMENSION AT MAXIMUM MATERIAL CONDITION. DAMBAR CANNOT BE LOCATED ON THE LOWER RADII OR THE FOOT
- 9 THESE DIMENSIONS APPLY TO THE FLAT SECTION OF THE LEAD BETWEEN .10 AND .25 mm FROM THE LEAD TIP
- 10 ALL DIMENSIONS ARE IN MILLIMETERS
- 11 THIS OUTLINE CONFORMS TO JEDEC PUBLICATION 95 REGISTRATION MO-150, VARIATION AB, AC, AE, AG & AH

02	REDRAW TO JEDEC FORMAT	03/15
03	ADD 14 & 16 LD	08/25
04	ADDED TOPMARK TO TITLE	5/23
05	ADD "GREEN" PYG NOMENCLATURE	10/12
06	ADDED PACKAGE CODE	12/12

TOLERANCES UNLESS SPECIFIED	
DECIMAL	±
ANGULAR	
XXX±	
XXXX±	
XXXX±	
APPROVALS	DATE
DRAWN	
CHECKED	
SIZE	DRAWING No.
C	PSC-402

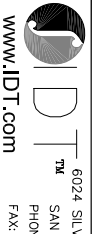

Package Outline and Package Dimensions, cont. (20-pin SSOP)

LAND PATTERN DIMENSIONS



MIN	MAX
8.60	8.80
5.10	5.30
5.85 BSC	
.30	.40
.65 BSC	
20	

REV	DESCRIPTION	DATE	APPROVED
00	INITIAL RELEASE	04/15/91	T. VU
01	ADD 28 LD	07/27/93	T. VU
02	REDRAW TO JEDEC FORMAT	03/15/95	T. VU
03	ADD 14 & 16 LD	08/25/98	T. VU
04	ADDED TOPMARK TO TITLE	5/23/01	T. VU
05	ADD "GREEN" PYG NOMENCLATURE	10/12/04	TU VU
06	ADDED PACKAGE CODE	12/12/12	RC

TOLERANCES UNLESS SPECIFIED	
DECIMAL	ANGULAR
XXX±	±
XXXX±	
APPROVALS	DATE
DRAWN	
CHECKED	
6024 SILVERCREEK VALLEY RD SAN JOSE CA 95138 PHONE: (408) 284-8200 FAX: (408) 284-8591 www.IDT.com	
TITLE PY/PYG PACKAGE OUTLINE (PY OR PV TOPMARK CODE) 5.3 mm BODY WIDTH SSOP .65 mm PITCH	
SIZE	DRAWING No.
REV	

Ordering Information

Part / Order Number	Marking	Shipping Packaging	Package	Temperature
74FCT3807SNDGI	see page 6	Tubes	20-pin VFQFPN	-40° to +105°C
74FCT3807SNDGI8		Tape and Reel	20-pin VFQFPN	-40° to +105°C
74FCT3807SPGGI		Tubes	20-pin TSSOP	-40° to +105°C
74FCT3807SPGGI8		Tape and Reel	20-pin TSSOP	-40° to +105°C
74FCT3807SQGI		Tubes	20-pin QSOP	-40° to +105°C
74FCT3807SQGI8		Tape and Reel	20-pin QSOP	-40° to +105°C
74FCT3807SPYGI		Tubes	20-pin SSOP	-40° to +105°C
74FCT3807SPYGI8		Tape and Reel	20-pin SSOP	-40° to +105°C

“G” after the two-letter package code denotes Pb-Free configuration, RoHS compliant.

Revision History

Rev.	Date	Originator	Description of Change
A	03/18/15	B. Chandhoke	Initial release.



Corporate Headquarters
6024 Silver Creek Valley Road
San Jose, CA 95138 USA

Sales
1-800-345-7015 or 408-284-8200
Fax: 408-284-2775
www.IDT.com

Tech Support
email: clocks@idt.com

DISCLAIMER Integrated Device Technology, Inc. (IDT) and its subsidiaries reserve the right to modify the products and/or specifications described herein at any time and at IDT's sole discretion. All information in this document, including descriptions of product features and performance, is subject to change without notice. Performance specifications and the operating parameters of the described products are determined in the independent state and are not guaranteed to perform the same way when installed in customer products. The information contained herein is provided without representation or warranty of any kind, whether express or implied, including, but not limited to, the suitability of IDT's products for any particular purpose, an implied warranty of merchantability, or non-infringement of the intellectual property rights of others. This document is presented only as a guide and does not convey any license under intellectual property rights of IDT or any third parties.

IDT's products are not intended for use in applications involving extreme environmental conditions or in life support systems or similar devices where the failure or malfunction of an IDT product can be reasonably expected to significantly affect the health or safety of users. Anyone using an IDT product in such a manner does so at their own risk, absent an express, written agreement by IDT.

Integrated Device Technology, IDT and the IDT logo are registered trademarks of IDT. Product specification subject to change without notice. Other trademarks and service marks used herein, including protected names, logos and designs, are the property of IDT or their respective third party owners.

Copyright ©2015 Integrated Device Technology, Inc.. All rights reserved.

Компания «Океан Электроники» предлагает заключение долгосрочных отношений при поставках импортных электронных компонентов на взаимовыгодных условиях!

Наши преимущества:

- Поставка оригинальных импортных электронных компонентов напрямую с производств Америки, Европы и Азии, а так же с крупнейших складов мира;
- Широкая линейка поставок активных и пассивных импортных электронных компонентов (более 30 млн. наименований);
- Поставка сложных, дефицитных, либо снятых с производства позиций;
- Оперативные сроки поставки под заказ (от 5 рабочих дней);
- Экспресс доставка в любую точку России;
- Помощь Конструкторского Отдела и консультации квалифицированных инженеров;
- Техническая поддержка проекта, помощь в подборе аналогов, поставка прототипов;
- Поставка электронных компонентов под контролем ВП;
- Система менеджмента качества сертифицирована по Международному стандарту ISO 9001;
- При необходимости вся продукция военного и аэрокосмического назначения проходит испытания и сертификацию в лаборатории (по согласованию с заказчиком);
- Поставка специализированных компонентов военного и аэрокосмического уровня качества (Xilinx, Altera, Analog Devices, Intersil, Interpoint, Microsemi, Actel, Aeroflex, Peregrine, VPT, Syfer, Eurofarad, Texas Instruments, MS Kennedy, Miteq, Cobham, E2V, MA-COM, Hittite, Mini-Circuits, General Dynamics и др.);

Компания «Океан Электроники» является официальным дистрибьютором и эксклюзивным представителем в России одного из крупнейших производителей разъемов военного и аэрокосмического назначения «JONHON», а так же официальным дистрибьютором и эксклюзивным представителем в России производителя высокотехнологичных и надежных решений для передачи СВЧ сигналов «FORSTAR».



JONHON

«JONHON» (основан в 1970 г.)

Разъемы специального, военного и аэрокосмического назначения:

(Применяются в военной, авиационной, аэрокосмической, морской, железнодорожной, горно- и нефтедобывающей отраслях промышленности)

«FORSTAR» (основан в 1998 г.)

ВЧ соединители, коаксиальные кабели,
кабельные сборки и микроволновые компоненты:

(Применяются в телекоммуникациях гражданского и специального назначения, в средствах связи, РЛС, а так же военной, авиационной и аэрокосмической отраслях промышленности).



Телефон: 8 (812) 309-75-97 (многоканальный)

Факс: 8 (812) 320-03-32

Электронная почта: ocean@oceanchips.ru

Web: <http://oceanchips.ru/>

Адрес: 198099, г. Санкт-Петербург, ул. Калинина, д. 2, корп. 4, лит. А