



+5V-Powered, Multichannel RS-232 Drivers/Receivers

MAX220-MAX249

General Description

The MAX220-MAX249 family of line drivers/receivers is intended for all EIA/TIA-232E and V.28/V.24 communications interfaces, particularly applications where $\pm 12V$ is not available.

These parts are especially useful in battery-powered systems, since their low-power shutdown mode reduces power dissipation to less than $5\mu W$. The MAX225, MAX233, MAX235, and MAX245/MAX246/MAX247 use no external components and are recommended for applications where printed circuit board space is critical.

Applications

Portable Computers
Low-Power Modems
Interface Translation
Battery-Powered RS-232 Systems
Multidrop RS-232 Networks

AutoShutdown and UCSP are trademarks of Maxim Integrated Products, Inc.

Next-Generation Device Features

- ◆ For Low-Voltage, Integrated ESD Applications
MAX3222E/MAX3232E/MAX3237E/MAX3241E/
MAX3246E: +3.0V to +5.5V, Low-Power, Up to
1Mbps, True RS-232 Transceivers Using Four
0.1 μF External Capacitors (MAX3246E Available
in a UCSP™ Package)
- ◆ For Low-Cost Applications
MAX221E: $\pm 15kV$ ESD-Protected, +5V, 1 μA ,
Single RS-232 Transceiver with AutoShutdown™

Ordering Information

| PART | TEMP RANGE | PIN-PACKAGE |
|------------|-----------------|----------------|
| MAX220CPE+ | 0°C to +70°C | 16 Plastic DIP |
| MAX220CSE+ | 0°C to +70°C | 16 Narrow SO |
| MAX220CWE+ | 0°C to +70°C | 16 Wide SO |
| MAX220C/D | 0°C to +70°C | Dice* |
| MAX220EPE+ | -40°C to +85°C | 16 Plastic DIP |
| MAX220ESE+ | -40°C to +85°C | 16 Narrow SO |
| MAX220EWE+ | -40°C to +85°C | 16 Wide SO |
| MAX220EJE | -40°C to +85°C | 16 CERDIP |
| MAX220MJE | -55°C to +125°C | 16 CERDIP |

+ Denotes a lead(Pb)-free/RoHS-compliant package.

* Contact factory for dice specifications.

Ordering Information continued at end of data sheet.

Selection Table

| Part Number | Power Supply (V) | No. of RS-232 Drivers/Rx | No. of Ext. Caps | Nominal Cap. Value (μF) | SHDN & Three-State | Rx Active in SHDN | Data Rate (kbps) | Features |
|-----------------|----------------------|--------------------------|------------------|--------------------------------|--------------------|-------------------|------------------|--|
| MAX220 | +5 | 2/2 | 4 | 0.047/0.33 | No | — | 120 | Ultra-low-power, industry-standard pinout |
| MAX222 | +5 | 2/2 | 4 | 0.1 | Yes | — | 200 | Low-power shutdown |
| MAX223 (MAX213) | +5 | 4/5 | 4 | 1.0 (0.1) | Yes | ✓ | 120 | MAX241 and receivers active in shutdown |
| MAX225 | +5 | 5/5 | 0 | — | Yes | ✓ | 120 | Available in SO |
| MAX230 (MAX200) | +5 | 5/0 | 4 | 1.0 (0.1) | Yes | — | 120 | 5 drivers with shutdown |
| MAX231 (MAX201) | +5 and +7.5 to +13.2 | 2/2 | 2 | 1.0 (0.1) | No | — | 120 | Standard +5/+12V or battery supplies; same functions as MAX232 |
| MAX232 (MAX202) | +5 | 2/2 | 4 | 1.0 (0.1) | No | — | 120 (64) | Industry standard |
| MAX232A | +5 | 2/2 | 4 | 0.1 | No | — | 200 | Higher slew rate, small caps |
| MAX233 (MAX203) | +5 | 2/2 | 0 | — | No | — | 120 | No external caps |
| MAX233A | +5 | 2/2 | 0 | — | No | — | 200 | No external caps, high slew rate |
| MAX234 (MAX204) | +5 | 4/0 | 4 | 1.0 (0.1) | No | — | 120 | Replaces 1488 |
| MAX235 (MAX205) | +5 | 5/5 | 0 | — | Yes | — | 120 | No external caps |
| MAX236 (MAX206) | +5 | 4/3 | 4 | 1.0 (0.1) | Yes | — | 120 | Shutdown, three state |
| MAX237 (MAX207) | +5 | 5/3 | 4 | 1.0 (0.1) | No | — | 120 | Complements IBM PC serial port |
| MAX238 (MAX208) | +5 | 4/4 | 4 | 1.0 (0.1) | No | — | 120 | Replaces 1488 and 1489 |
| MAX239 (MAX209) | +5 and +7.5 to +13.2 | 3/5 | 2 | 1.0 (0.1) | No | — | 120 | Standard +5/+12V or battery supplies; single-package solution for IBM PC serial port |
| MAX240 | +5 | 5/5 | 4 | 1.0 | Yes | — | 120 | DIP or flatpack package |
| MAX241 (MAX211) | +5 | 4/5 | 4 | 1.0 (0.1) | Yes | — | 120 | Complete IBM PC serial port |
| MAX242 | +5 | 2/2 | 4 | 0.1 | Yes | ✓ | 200 | Separate shutdown and enable |
| MAX243 | +5 | 2/2 | 4 | 0.1 | No | — | 200 | Open-line detection simplifies cabling |
| MAX244 | +5 | 8/10 | 4 | 1.0 | No | — | 120 | High slew rate |
| MAX245 | +5 | 8/10 | 0 | — | Yes | ✓ | 120 | High slew rate, int. caps, two shutdown modes |
| MAX246 | +5 | 8/10 | 0 | — | Yes | ✓ | 120 | High slew rate, int. caps, three shutdown modes |
| MAX247 | +5 | 8/9 | 0 | — | Yes | ✓ | 120 | High slew rate, int. caps, nine operating modes |
| MAX248 | +5 | 8/8 | 4 | 1.0 | Yes | ✓ | 120 | High slew rate, selective half-chip enables |
| MAX249 | +5 | 6/10 | 4 | 1.0 | Yes | ✓ | 120 | Available in quad flatpack package |



+5V-Powered, Multichannel RS-232 Drivers/Receivers

ABSOLUTE MAXIMUM RATINGS—MAX220/222/232A/233A/242/243

(Voltages referenced to GND.)

| | |
|---|-----------------------------------|
| V _{CC} | -0.3V to +6V |
| V ₊ (Note 1)..... | (V _{CC} - 0.3V) to +14V |
| V ₋ (Note 1)..... | +0.3V to -14V |
| Input Voltages | |
| T _{IN} | -0.3V to (V _{CC} - 0.3V) |
| R _{IN} (Except MAX220)..... | ±30V |
| R _{IN} (MAX220)..... | ±25V |
| T _{OUT} (Except MAX220) (Note 2)..... | ±15V |
| T _{OUT} (MAX220)..... | ±13.2V |
| Output Voltages | |
| T _{OUT} | ±15V |
| R _{OUT} | -0.3V to (V _{CC} + 0.3V) |
| Driver/Receiver Output Short Circuited to GND..... | Continuous |
| Continuous Power Dissipation (T _A = +70°C) | |
| 16-Pin Plastic DIP (derate 10.53mW/°C above +70°C)..... | .842mW |
| 18-Pin Plastic DIP (derate 11.11mW/°C above +70°C)..... | .889mW |
| 20-Pin Plastic DIP (derate 8.00mW/°C above +70°C)..... | .440mW |

| | |
|--|-----------------|
| 16-Pin Narrow SO (derate 8.70mW/°C above +70°C)..... | 696mW |
| 16-Pin Wide SO (derate 9.52mW/°C above +70°C)..... | 762mW |
| 18-Pin Wide SO (derate 9.52mW/°C above +70°C)..... | 762mW |
| 20-Pin Wide SO (derate 10.00mW/°C above +70°C)..... | 800mW |
| 20-Pin SSOP (derate 8.00mW/°C above +70°C)..... | 640mW |
| 16-Pin CERDIP (derate 10.00mW/°C above +70°C)..... | 800mW |
| 18-Pin CERDIP (derate 10.53mW/°C above +70°C)..... | 842mW |
| Operating Temperature Ranges | |
| MAX2_AC_, MAX2_C_..... | 0°C to +70°C |
| MAX2_AE_, MAX2_E_..... | -40°C to +85°C |
| MAX2_AM_, MAX2_M_..... | -55°C to +125°C |
| Storage Temperature Range..... | -65°C to +160°C |
| Lead Temperature (soldering, 10s)..... | +300°C |
| Soldering Temperature (reflow) | |
| 20 PDIP (P20M+1)..... | +225°C |
| All other lead(Pb)-free packages..... | +260°C |
| All other packages containing lead(Pb)..... | +240°C |

Note 1: For the MAX220, V₊ and V₋ can have a maximum magnitude of 7V, but their absolute difference cannot exceed 13V.

Note 2: Input voltage measured with T_{OUT} in high-impedance state, V_{SHDN} or V_{CC} = 0V.

Stresses beyond those listed under “Absolute Maximum Ratings” may cause permanent damage to the device. These are stress ratings only, and functional operation of the device at these or any other conditions beyond those indicated in the operational sections of the specifications is not implied. Exposure to absolute maximum rating conditions for extended periods may affect device reliability.

ELECTRICAL CHARACTERISTICS—MAX220/222/232A/233A/242/243

(V_{CC} = +5V ±10%, C₁–C₄ = 0.1µF, MAX220, C₁ = 0.047µF, C₂–C₄ = 0.33µF, T_A = T_{MIN} to T_{MAX}, unless otherwise noted.) (Note 3)

| PARAMETER | CONDITIONS | | MIN | TYP | MAX | UNITS |
|--------------------------------------|---|---------------------------------|------|-------|-----|-------|
| RS-232 TRANSMITTERS | | | | | | |
| Output Voltage Swing | All transmitter outputs loaded with 3kΩ to GND | | ±5 | ±8 | | V |
| Input Logic-Low Voltage | | | | 1.4 | 0.8 | V |
| Input Logic-High Voltage | All devices except MAX220 | | 2 | 1.4 | | V |
| | MAX220: V _{CC} = +5.0V | | 2.4 | | | |
| Logic Pullup/Input Current | All except MAX220, normal operation | | | 5 | 40 | µA |
| | V _{SHDN} = 0V, MAX222/MAX242, shutdown, MAX220 | | | ±0.01 | ±1 | |
| Output Leakage Current | V _{CC} = +5.5V, V _{SHDN} = 0V, V _{OUT} = ±15V, MAX222/MAX242 | | | ±0.01 | ±10 | µA |
| | V _{CC} = V _{SHDN} = 0V | V _{OUT} = ±15V | | ±0.01 | ±10 | |
| | | MAX220, V _{OUT} = ±12V | | | ±25 | |
| Data Rate | | | | 200 | 116 | kbps |
| Transmitter Output Resistance | V _{CC} = V ₊ = V ₋ = 0V, V _{OUT} = ±2V | | 300 | 10M | | Ω |
| Output Short-Circuit Current | V _{OUT} = 0V | V _{OUT} = 0V | ±7 | ±22 | | mA |
| | | MAX220 | | | ±60 | |
| RS-232 RECEIVERS | | | | | | |
| RS-232 Input Voltage Operating Range | | | | | ±30 | V |
| | MAX220 | | | | ±25 | |
| RS-232 Input Threshold Low | V _{CC} = +5V | All except MAX243 R2IN | 0.8 | 1.3 | | V |
| | | MAX243 R2IN (Note 4) | -3 | | | |
| RS-232 Input Threshold High | V _{CC} = +5V | All except MAX243 R2IN | | 1.8 | 2.4 | V |
| | | MAX243 R2IN (Note 4) | -0.5 | -0.1 | | |

+5V-Powered, Multichannel RS-232 Drivers/Receivers

MAX220-MAX249

ELECTRICAL CHARACTERISTICS—MAX220/222/232A/233A/242/243 (continued)

(V_{CC} = +5V ±10%, C1–C4 = 0.1µF, MAX220, C1 = 0.047µF, C2–C4 = 0.33µF, T_A = T_{MIN} to T_{MAX}, unless otherwise noted.) (Note 3)

| PARAMETER | CONDITIONS | | MIN | TYP | MAX | UNITS |
|---|---|--------------------------------------|-------|-----------------------|------|-------|
| RS-232 Input Hysteresis | All except MAX220/MAX243, V _{CC} = +5V, no hysteresis in shutdown | | 0.2 | 0.5 | 1.0 | V |
| | MAX220 | | 0.3 | | | |
| | MAX243 | | 1 | | | |
| RS-232 Input Resistance | T _A = +25°C (MAX220) | | 3 | 5 | 7 | kΩ |
| | | | 3 | 5 | 7 | |
| TTL/CMOS Output Voltage Low | I _{OUT} = 3.2mA | | 0.2 | | 0.4 | V |
| | I _{OUT} = 1.6mA (MAX220) | | 0.4 | | | |
| TTL/CMOS Output Voltage High | I _{OUT} = -1.0mA | | 3.5 | V _{CC} - 0.2 | | V |
| TTL/CMOS Output Short-Circuit Current | Sourcing V _{OUT} = V _{GND} | | -2 | -10 | | mA |
| | Sinking V _{OUT} = V _{CC} | | 10 | 30 | | |
| TTL/CMOS Output Leakage Current | V _{SHDN} = V _{CC} or V _{EN} = V _{CC} (V _{SHDN} = 0V for MAX222), 0V ≤ V _{OUT} ≤ V _{CC} | | ±0.05 | | ±10 | µA |
| EN Input Threshold Low | MAX242 | | 1.4 | | 0.8 | V |
| EN Input Threshold High | MAX242 | | 2.0 | 1.4 | | V |
| Supply Voltage Range | | | 4.5 | 5.5 | | V |
| V _{CC} Supply Current (V _{SHDN} = V _{CC}), Figures 5, 6, 11, 19 | No load | MAX220 | 0.5 | | 2 | mA |
| | | MAX222/MAX232A/MAX233A/MAX242/MAX243 | 4 | | 10 | |
| | 3kΩ load both inputs | MAX220 | 12 | | | |
| | | MAX222/MAX232A/MAX233A/MAX242/MAX243 | 15 | | | |
| Shutdown Supply Current | MAX222/MAX242 | T _A = +25°C | 0.1 | | 10 | µA |
| | | T _A = 0°C to +70°C | 2 | | 50 | |
| | | T _A = -40°C to +85°C | 2 | | 50 | |
| | | T _A = -55°C to +125°C | 35 | | 100 | |
| SHDN Input Leakage Current | MAX222/MAX242 | | | | ±1 | µA |
| SHDN Threshold Low | MAX222/MAX242 | | 1.4 | | 0.8 | V |
| SHDN Threshold High | MAX222/MAX242 | | 2.0 | 1.4 | | V |
| Transition Slew Rate | C _L = 50pF to 2500pF, R _L = 3kΩ to 7kΩ, V _{CC} = +5V, T _A = +25°C, measured from +3V to -3V or -3V to +3V | MAX222/MAX232A/MAX233/MAX242/MAX243 | 6 | 12 | 30 | V/µs |
| | | MAX220 | 1.5 | 3 | 30.0 | |
| Transmitter Propagation Delay TLL to RS-232 (Normal Operation) | t _{PHLT} , Figure 1 | MAX222/MAX232A/MAX233/MAX242/MAX243 | 1.3 | | 3.5 | µs |
| | | MAX220 | 4 | | 10 | |
| | t _{PLHT} , Figure 1 | MAX222/MAX232A/MAX233/MAX242/MAX243 | 1.5 | | 3.5 | |
| | | MAX220 | 5 | | 10 | |

+5V-Powered, Multichannel RS-232 Drivers/Receivers

ELECTRICAL CHARACTERISTICS—MAX220/222/232A/233A/242/243 (continued)

($V_{CC} = +5V \pm 10\%$, $C1-C4 = 0.1\mu F$, MAX220, $C1 = 0.047\mu F$, $C2-C4 = 0.33\mu F$, $T_A = T_{MIN}$ to T_{MAX} , unless otherwise noted.) (Note 3)

| PARAMETER | CONDITIONS | MIN | TYP | MAX | UNITS |
|--|-----------------------|---|------|-----|---------|
| Receiver Propagation Delay RS-232 to TLL (Normal Operation) | t_{PHLR} , Figure 2 | MAX222/MAX232A/MAX233/ MAX242/MAX243 | 0.5 | 1 | μs |
| | | MAX220 | 0.6 | 3 | |
| | t_{PLHR} , Figure 2 | MAX222/MAX232A/MAX233/ MAX242/MAX243 | 0.6 | 1 | |
| | | MAX220 | 0.8 | 3 | |
| Receiver Propagation Delay RS-232 to TLL (Shutdown) | t_{PHLS} , Figure 2 | MAX242 | 0.5 | 10 | μs |
| | t_{PLHS} , Figure 2 | MAX242 | 2.5 | 10 | |
| Receiver-Output Enable Time | t_{ER} | MAX242, Figure 3 | 125 | 500 | ns |
| Receiver-Output Disable Time | t_{DR} | MAX242, Figure 3 | 160 | 500 | ns |
| Transmitter-Output Enable Time (SHDN Goes High) | t_{ET} | MAX222/MAX242, 0.1 μF caps (includes charge-pump start-up), Figure 4 | 250 | | μs |
| Transmitter-Output Disable Time (SHDN Goes Low) | t_{DT} | MAX222/MAX242, 0.1 μF caps, Figure 4 | 600 | | ns |
| Transmitter + to - Propagation Delay Difference (Normal Operation) | $t_{PHLT} - t_{PLHT}$ | MAX222/MAX232A/MAX233/ MAX242/MAX243 | 300 | | ns |
| | | MAX220 | 2000 | | |
| Receiver + to - Propagation Delay Difference (Normal Operation) | $t_{PHLR} - t_{PLHR}$ | MAX222/MAX232A/MAX233/ MAX242/MAX243 | 100 | | ns |
| | | MAX220 | 225 | | |

Note 3: All units are production tested at hot. Specifications over temperature are guaranteed by design.

Note 4: MAX243 R2OUT is guaranteed to be low when R2IN $\geq 0V$ or is unconnected.

Typical Operating Characteristics

MAX220/MAX222/MAX232A/MAX233A/MAX242/MAX243

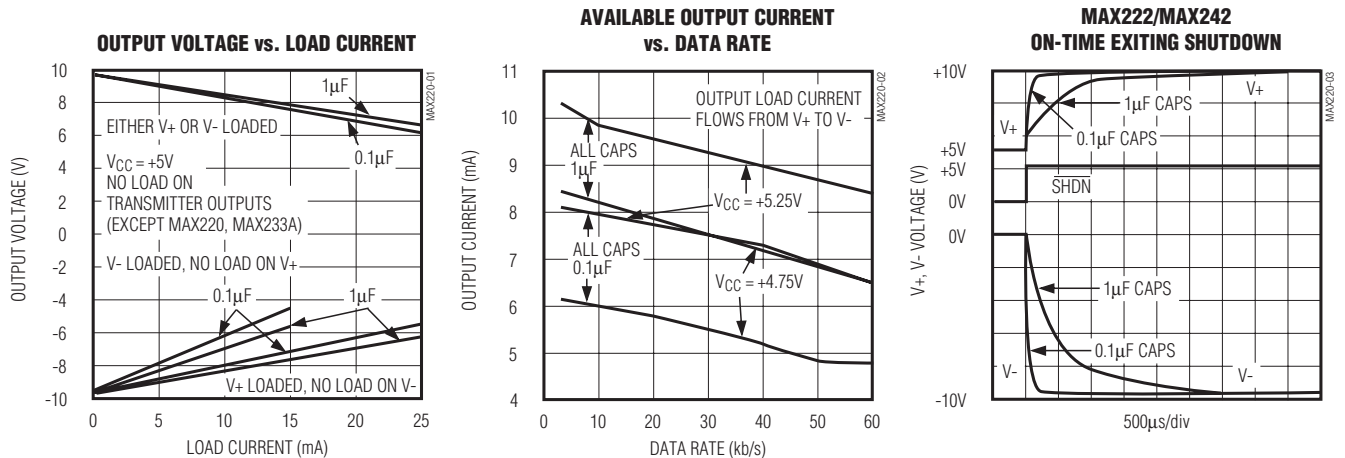

+5V-Powered, Multichannel RS-232 Drivers/Receivers

MAX2220-MAX249

ABSOLUTE MAXIMUM RATINGS—MAX223/MAX230-MAX241

(Voltages referenced to GND.)

| | |
|--|--|
| V _{CC} | -0.3V to +6V |
| V ₊ | (V _{CC} - 0.3V) to +14V |
| V ₋ | +0.3V to -14V |
| Input Voltages | |
| T _{IN} | -0.3V to (V _{CC} + 0.3V) |
| R _{IN} | ±30V |
| Output Voltages | |
| T _{OUT} | (V ₊ + 0.3V) to (V ₋ - 0.3V) |
| R _{OUT} | -0.3V to (V _{CC} + 0.3V) |
| Short-Circuit Duration, T _{OUT} to GND | |
| Continuous Power Dissipation (T _A = +70°C) | |
| 14-Pin Plastic DIP (derate 10.00mW/°C above +70°C)..... | 800mW |
| 16-Pin Plastic DIP (derate 10.53mW/°C above +70°C)..... | 842mW |
| 20-Pin Plastic DIP (derate 11.11mW/°C above +70°C)..... | 889mW |
| 24-Pin Narrow Plastic DIP (derate 13.33mW/°C above +70°C) | 1.07W |
| 24-Pin Plastic DIP (derate 9.09mW/°C above +70°C)..... | 500mW |
| 16-Pin Wide SO (derate 9.52mW/°C above +70°C)..... | 762mW |
| 20-Pin Wide SO (derate 10.00mW/°C above +70°C)..... | 800mW |
| 24-Pin Wide SO (derate 11.76mW/°C above +70°C)..... | 941mW |

| | |
|---|-----------------|
| 28-Pin Wide SO (derate 12.50mW/°C above +70°C) | 1W |
| 44-Pin Plastic FP (derate 11.11mW/°C above +70°C) | 889mW |
| 14-Pin CERDIP (derate 9.09mW/°C above +70°C) | 727mW |
| 16-Pin CERDIP (derate 10.00mW/°C above +70°C) | 800mW |
| 20-Pin CERDIP (derate 11.11mW/°C above +70°C) | 889mW |
| 24-Pin Narrow CERDIP (derate 12.50mW/°C above +70°C) | 1W |
| 24-Pin Sidebrazed (derate 20.0mW/°C above +70°C)..... | 1.6W |
| 28-Pin SSOP (derate 9.52mW/°C above +70°C)..... | 762mW |
| Operating Temperature Ranges | |
| MAX2 __ C __ | 0°C to +70°C |
| MAX2 __ E __ | -40°C to +85°C |
| MAX2 __ M __ | -55°C to +125°C |
| Storage Temperature Range | |
| -65°C to +160°C | |
| Lead Temperature (soldering, 10s) | |
| +300°C | |
| Soldering Temperature (reflow) | |
| 20 PDIP (P20M+1) | +225°C |
| 24 PDIP (P24M-1) | +225°C |
| All other lead(Pb)-free packages | +260°C |
| All other packages containing lead(Pb) | +240°C |

Stresses beyond those listed under "Absolute Maximum Ratings" may cause permanent damage to the device. These are stress ratings only, and functional operation of the device at these or any other conditions beyond those indicated in the operational sections of the specifications is not implied. Exposure to absolute maximum rating conditions for extended periods may affect device reliability.

ELECTRICAL CHARACTERISTICS—MAX223/MAX230-MAX241

(MAX223/230/232/234/236/237/238/240/241, V_{CC} = +5V ±10%; MAX233/MAX235, V_{CC} = +5V ±5%, C₁-C₄ = 1.0μF; MAX231/MAX239, V_{CC} = +5V ±10%; V₊ = +7.5V to +13.2V; T_A = T_{MIN} to T_{MAX}; unless otherwise noted.) (Note 5)

| PARAMETER | CONDITIONS | MIN | TYP | MAX | UNITS |
|--|---|----------------------------|------|-----|-------|
| Output Voltage Swing | All transmitter outputs loaded with 3kΩ to ground | ±5.0 | ±7.3 | | V |
| V _{CC} Supply Current | No load, T _A = +25°C | MAX232/233 | 5 | 10 | mA |
| | | MAX223/230/234-238/240/241 | 7 | 15 | |
| | | MAX231/239 | 0.4 | 1 | |
| V ₊ Supply Current | | MAX231 | 1.8 | 5 | mA |
| | | MAX239 | 5 | 15 | |
| Shutdown Supply Current | T _A = +25°C | MAX223 | 15 | 50 | μA |
| | | MAX230/235/236/240/241 | 1 | 10 | |
| Input Logic-Low Voltage | T _{IN} , EN, $\overline{\text{SHDN}}$ (MAX233); $\overline{\text{EN}}$, SHDN (MAX230/235-241) | | | 0.8 | V |
| Input Logic-High Voltage | T _{IN} | 2.0 | | | V |
| | $\overline{\text{EN}}$, $\overline{\text{SHDN}}$ (MAX223); $\overline{\text{EN}}$, SHDN (MAX230/235/236/240/241) | 2.4 | | | |
| Logic Pullup Current | V _{TIN} = 0V | | 1.5 | 200 | μA |
| Receiver Input Voltage Operating Range | | -30 | | +30 | V |

+5V-Powered, Multichannel RS-232 Drivers/Receivers

ELECTRICAL CHARACTERISTICS—MAX223/MAX230–MAX241 (continued)

(MAX223/230/232/234/236/237/238/240/241, $V_{CC} = +5V \pm 10\%$; MAX233/MAX235, $V_{CC} = +5V \pm 5\%$, $C_1-C_4 = 1.0\mu F$; MAX231/MAX239, $V_{CC} = +5V \pm 10\%$; $V_+ = +7.5V$ to $+13.2V$; $T_A = T_{MIN}$ to T_{MAX} ; unless otherwise noted.) (Note 5)

| PARAMETER | CONDITIONS | | MIN | TYP | MAX | UNITS |
|--|---|---|------------|----------------|----------|------------|
| RS-232 Input Logic-Low Voltage | $T_A = +25^\circ C$, $V_{CC} = +5V$ | Normal operation $V_{SHDN} = +5V$ (MAX223) $V_{SHDN} = 0V$ (MAX235/236/240/241) | 0.8 | 1.2 | | V |
| | | Shutdown (MAX223) $V_{SHDN} = 0V$, $V_{EN} = +5V$ (R4IN, R5IN) | 0.6 | 1.5 | | |
| RS-232 Input Logic-High Voltage | $T_A = +25^\circ C$, $V_{CC} = +5V$ | Normal operation $V_{SHDN} = 5V$ (MAX223) $V_{SHDN} = 0V$ (MAX235/236/240/241) | | 1.7 | 2.4 | V |
| | | Shutdown (MAX223) $V_{SHDN} = 0V$, $V_{EN} = +5V$ (R4IN, R5IN) | | 1.5 | 2.4 | |
| RS-232 Input Hysteresis | $V_{CC} = +5V$, no hysteresis in shutdown | | 0.2 | 0.5 | 1.0 | V |
| RS-232 Input Resistance | $T_A = +25^\circ C$, $V_{CC} = +5V$ | | 3 | 5 | 7 | k Ω |
| TTL/CMOS Output Voltage Low | $I_{OUT} = 1.6mA$ (MAX231/232/233, $I_{OUT} = 3.2mA$) | | | | 0.4 | V |
| TTL/CMOS Output Voltage High | $I_{OUT} = -1mA$ | | 3.5 | $V_{CC} - 0.4$ | | V |
| TTL/CMOS Output Leakage Current | $0V \leq R_{OUT} \leq V_{CC}$; $V_{EN} = 0V$ (MAX223); $V_{EN} = V_{CC}$ (MAX235–241) | | | ± 0.05 | ± 10 | μA |
| Receiver Output Enable Time | Normal operation | MAX223 | | 600 | | ns |
| | | MAX235/236/239/240/241 | | 400 | | |
| Receiver Output Disable Time | Normal operation | MAX223 | | 900 | | ns |
| | | MAX235/236/239/240/241 | | 250 | | |
| Propagation Delay | RS-232 IN to TTL/CMOS OUT, $C_L = 150pF$ | Normal operation | | 0.5 | 10 | μs |
| | | $V_{SHDN} = 0V$ (MAX223) | t_{PHLS} | 4 | 40 | |
| | | | t_{PLHS} | 6 | 40 | |
| Transition Region Slew Rate | MAX223/MAX230/MAX234–241, $T_A = +25^\circ C$, $V_{CC} = +5V$, $R_L = 3k\Omega$ to $7k\Omega$, $C_L = 50pF$ to $2500pF$, measured from $+3V$ to $-3V$ or $-3V$ to $+3V$ | | 3 | 5.1 | 30 | V/ μs |
| | MAX231/MAX232/MAX233, $T_A = +25^\circ C$, $V_{CC} = +5V$, $R_L = 3k\Omega$ to $7k\Omega$, $C_L = 50pF$ to $2500pF$, measured from $+3V$ to $-3V$ or $-3V$ to $+3V$ | | | 4 | 30 | |
| Transmitter Output Resistance | $V_{CC} = V_+ = V_- = 0V$, $V_{OUT} = \pm 2V$ | | 300 | | | Ω |
| Transmitter Output Short-Circuit Current | | | ± 10 | | | mA |

Note 5: All units are production tested at hot except for the MAX240, which is production tested at $T_A = +25^\circ C$. Specifications over temperature are guaranteed by design.

+5V-Powered, Multichannel RS-232 Drivers/Receivers

Typical Operating Characteristics

MAX220-MAX249

MAX223/MAX230-MAX241

TRANSMITTER OUTPUT VOLTAGE (V_{OH}) vs. V_{CC}

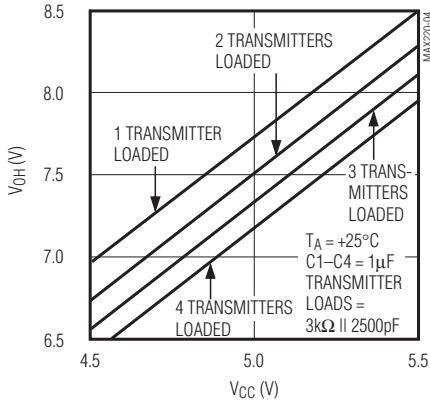

TRANSMITTER OUTPUT VOLTAGE (V_{OH}) vs. LOAD CAPACITANCE AT DIFFERENT DATA RATES

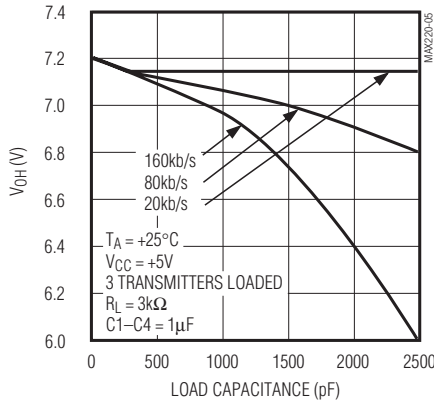

TRANSMITTER SLEW RATE vs. LOAD CAPACITANCE

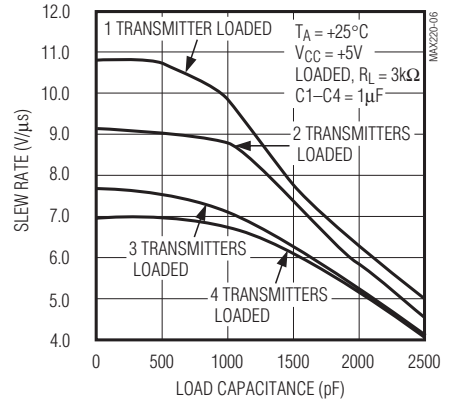

TRANSMITTER OUTPUT VOLTAGE (V_{OL}) vs. V_{CC}

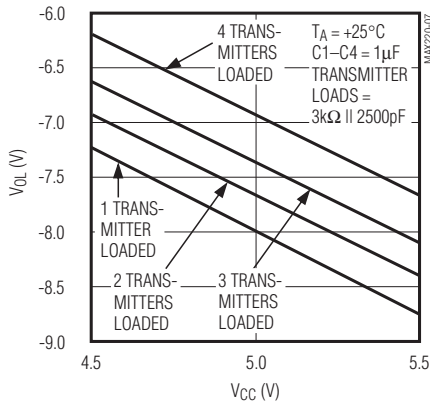

TRANSMITTER OUTPUT VOLTAGE (V_{OL}) vs. LOAD CAPACITANCE AT DIFFERENT DATA RATES

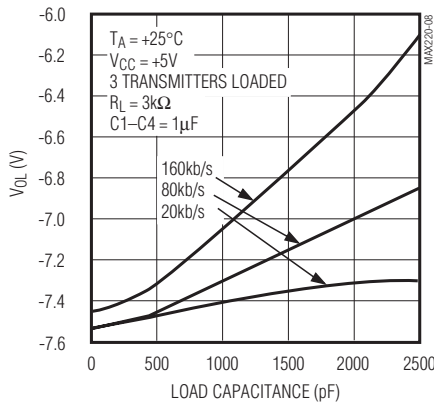

TRANSMITTER OUTPUT VOLTAGE (V_+ , V_-) vs. LOAD CURRENT

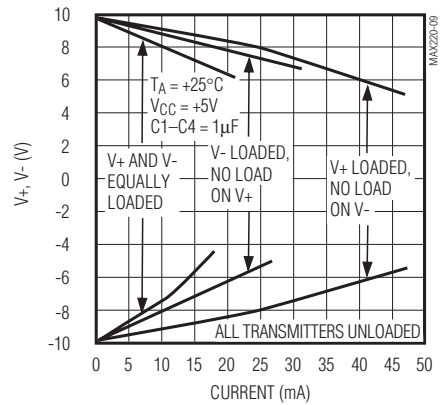

V_+ , V_- WHEN EXITING SHUTDOWN (1µF CAPACITORS)

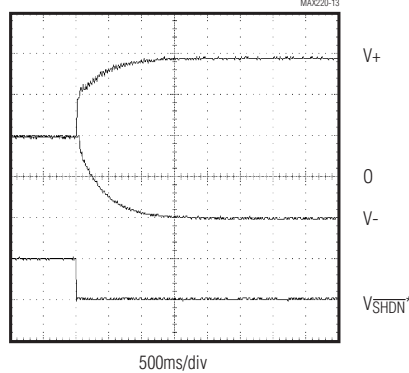

*SHUTDOWN POLARITY IS REVERSED FOR NON MAX241 PARTS

+5V-Powered, Multichannel RS-232 Drivers/Receivers

ABSOLUTE MAXIMUM RATINGS—MAX225/MAX244-MAX249

(Voltages referenced to GND.)

| | |
|---|-----------------------------------|
| Supply Voltage (V _{CC}) | -0.3V to +6V |
| Input Voltages | |
| T _{IN} , EN _A , EN _B , EN _R , EN _T , EN _{RA} , EN _{RB} , EN _{TA} , EN _{TB} | -0.3V to (V _{CC} + 0.3V) |
| R _{IN} | ±25V |
| T _{OUT} (Note 6) | ±15V |
| R _{OUT} | -0.3V to (V _{CC} + 0.3V) |
| Short Circuit Duration (one output at a time) | |
| T _{OUT} to GND | Continuous |
| R _{OUT} to GND | Continuous |

Continuous Power Dissipation (T_A = +70°C)

| | |
|--|-------|
| 28-Pin Wide SO (derate 12.50mW/°C above +70°C) | 1W |
| 40-Pin Plastic DIP (derate 11.11mW/°C above +70°C) | 611mW |
| 44-Pin PLCC (derate 13.33mW/°C above +70°C) | 1.07W |

Operating Temperature Ranges

| | |
|----------------------|----------------|
| MAX225C_-, MAX24_C_- | 0°C to +70°C |
| MAX225E_-, MAX24_E_- | -40°C to +85°C |

Storage Temperature Range

-65°C to +160°C

Lead Temperature (soldering, 10s)

+300°C

Soldering Temperature (reflow)

40 PDIP (P40M-2) +225°C

All other lead(Pb)-free packages +260°C

All other packages containing lead(Pb) +240°C

Note 6: Input voltage measured with transmitter output in a high-impedance state, shutdown, or V_{CC} = 0V.

Stresses beyond those listed under "Absolute Maximum Ratings" may cause permanent damage to the device. These are stress ratings only, and functional operation of the device at these or any other conditions beyond those indicated in the operational sections of the specifications is not implied. Exposure to absolute maximum rating conditions for extended periods may affect device reliability.

ELECTRICAL CHARACTERISTICS—MAX225/MAX244-MAX249

(MAX225, V_{CC} = +5.0V ±5%; MAX244-MAX249, V_{CC} = +5.0V ±10%, external capacitors C1-C4 = 1μF; T_A = T_{MIN} to T_{MAX}; unless otherwise noted.) (Note 7)

| PARAMETER | CONDITIONS | MIN | TYP | MAX | UNITS | |
|---------------------------------------|--|--|-----------------------|-------|-------|----|
| RS-232 TRANSMITTERS | | | | | | |
| Input Logic-Low Voltage | | | 1.4 | 0.8 | V | |
| Input Logic-High Voltage | | 2 | 1.4 | | V | |
| Logic Pullup/Input Current | Tables 1a-1d | Normal operation | | 10 | 50 | μA |
| | | Shutdown | | ±0.01 | ±1 | |
| Data Rate | Tables 1a-1d, normal operation | | 120 | 64 | kbps | |
| Output Voltage Swing | All transmitter outputs loaded with 3kΩ to GND | ±5 | ±7.5 | | V | |
| Output Leakage Current (Shutdown) | Tables 1a-1d | V _{ENA} , V _{ENB} , V _{ENT} , V _{ENT_A} , V _{ENT_B} = V _{CC} , V _{OUT} = ±15V | | ±0.01 | ±25 | μA |
| | | V _{CC} = 0V, V _{OUT} = ±15V | | ±0.01 | ±25 | |
| Transmitter Output Resistance | V _{CC} = V ₊ = V ₋ = 0V, V _{OUT} = ±2V (Note 8) | 300 | 10M | | Ω | |
| Output Short-Circuit Current | V _{OUT} = 0V | ±7 | ±30 | | mA | |
| RS-232 RECEIVERS | | | | | | |
| RS-232 Input Voltage Operating Range | | | | ±25 | V | |
| RS-232 Input Logic-Low Voltage | V _{CC} = +5V | 0.8 | 1.3 | | V | |
| RS-232 Input Logic-High Voltage | V _{CC} = +5V | | 1.8 | 2.4 | V | |
| RS-232 Input Hysteresis | V _{CC} = +5V | 0.2 | 0.5 | 1.0 | V | |
| RS-232 Input Resistance | | 3 | 5 | 7 | kΩ | |
| TTL/CMOS Output Voltage Low | I _{OUT} = 3.2mA | | 0.2 | 0.4 | V | |
| TTL/CMOS Output Voltage High | I _{OUT} = -1.0mA | 3.5 | V _{CC} - 0.2 | | V | |
| TTL/CMOS Output Short-Circuit Current | Sourcing V _{OUT} = V _{GND} | -2 | -10 | | mA | |
| | Sinking V _{OUT} = V _{CC} | 10 | 30 | | | |
| TTL/CMOS Output Leakage Current | Normal operation, outputs disabled, Tables 1a-1d, 0V ≤ V _{OUT} ≤ V _{CC} , V _{ENR_C} = V _{CC} | | ±0.05 | ±0.10 | μA | |

+5V-Powered, Multichannel RS-232 Drivers/Receivers

MAX220-MAX249

ELECTRICAL CHARACTERISTICS—MAX225/MAX244-MAX249 (continued)

(MAX225, $V_{CC} = +5.0V \pm 5\%$; MAX244-MAX249, $V_{CC} = +5.0V \pm 10\%$, external capacitors C1-C4 = 1 μ F; $T_A = T_{MIN}$ to T_{MAX} ; unless otherwise noted.) (Note 7)

| PARAMETER | CONDITIONS | MIN | TYP | MAX | UNITS |
|--|--|---|-----|---------|------------|
| POWER SUPPLY AND CONTROL LOGIC | | | | | |
| Supply Voltage Range | MAX225 | 4.75 | | 5.25 | V |
| | MAX244-MAX249 | 4.5 | | 5.5 | |
| V_{CC} Supply Current (Normal Operation) | No load | MAX225 | 10 | 20 | mA |
| | | MAX244-MAX249 | 11 | 30 | |
| | 3k Ω loads on all outputs | MAX225 | 40 | | |
| | | MAX244-MAX249 | 57 | | |
| Shutdown Supply Current | $T_A = +25^\circ\text{C}$ | | 8 | 25 | μ A |
| | $T_A = T_{MIN}$ to T_{MAX} | | | 50 | |
| Control Input | Leakage current | | | ± 1 | μ A |
| | Logic-low voltage | | 1.4 | 0.8 | V |
| | Logic-high voltage | 2.4 | 1.4 | | |
| AC CHARACTERISTICS | | | | | |
| Transition Slew Rate | $C_L = 50\text{pF}$ to 2500pF , $R_L = 3\text{k}\Omega$ to $7\text{k}\Omega$, $V_{CC} = +5\text{V}$, $T_A = +25^\circ\text{C}$, measured from +3V to -3V or -3V to +3V | 5 | 10 | 30 | V/ μ s |
| Transmitter Propagation Delay TLL to RS-232 (Normal Operation) | t_{PHLT} , Figure 1 | | 1.3 | 3.5 | μ s |
| | t_{PLHT} , Figure 1 | | 1.5 | 3.5 | |
| Receiver Propagation Delay TLL to RS-232 (Normal Operation) | t_{PHLR} , Figure 2 | | 0.6 | 1.5 | μ s |
| | t_{PLHR} , Figure 2 | | 0.6 | 1.5 | |
| Receiver Propagation Delay TLL to RS-232 (Low-Power Mode) | t_{PHLS} , Figure 2 | | 0.6 | 10 | μ s |
| | t_{PLHS} , Figure 2 | | 3.0 | 10 | |
| Transmitter + to - Propagation Delay Difference (Normal Operation) | $t_{PHLT} - t_{PLHT}$ | | 350 | | ns |
| Receiver + to - Propagation Delay Difference (Normal Operation) | $t_{PHLR} - t_{PLHR}$ | | 350 | | ns |
| Receiver-Output Enable Time | t_{ER} , Figure 3 | | 100 | 500 | ns |
| Receiver-Output Disable Time | t_{DR} , Figure 3 | | 100 | 500 | ns |
| Transmitter Enable Time | t_{ET} | MAX246-MAX249 (excludes charge-pump startup) | 5 | | μ s |
| | | MAX225/MAX245-MAX249 (includes charge-pump startup) | 10 | | ms |
| Transmitter Disable Time | t_{DT} , Figure 4 | | 100 | | ns |

Note 7: All units production tested at hot. Specifications over temperature are guaranteed by design.

Note 8: The 300 Ω minimum specification complies with EIA/TIA-232E, but the actual resistance when in shutdown mode or $V_{CC} = 0\text{V}$ is 10M Ω as is implied by the leakage specification.

+5V-Powered, Multichannel RS-232 Drivers/Receivers

Typical Operating Characteristics

MAX225/MAX244-MAX249

TRANSMITTER SLEW RATE vs. LOAD CAPACITANCE

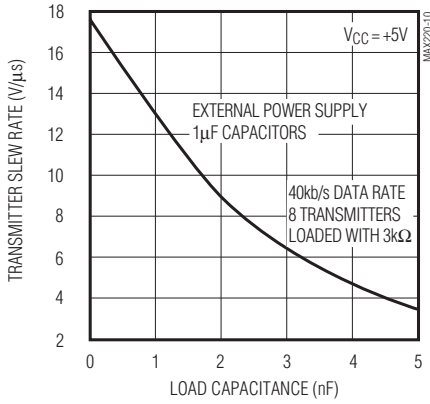

OUTPUT VOLTAGE vs. LOAD CURRENT FOR V+ AND V-

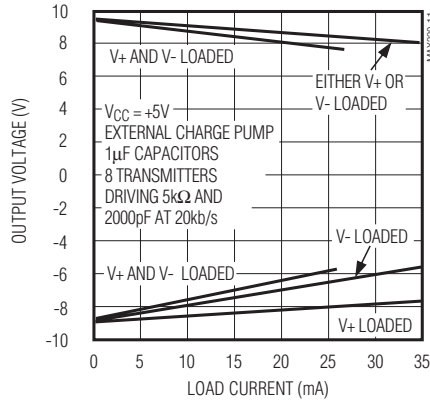

TRANSMITTER OUTPUT VOLTAGE (V+, V-) vs. LOAD CAPACITANCE AT DIFFERENT DATA RATES

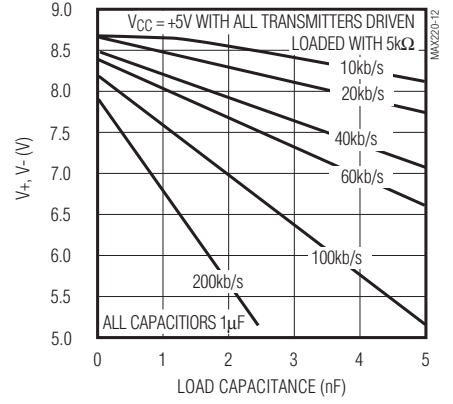

+5V-Powered, Multichannel RS-232 Drivers/Receivers

Test Circuits/Timing Diagrams

MAX220-MAX249

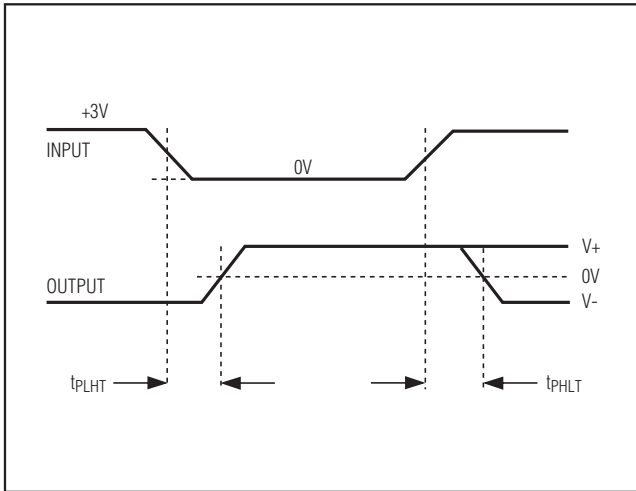

Figure 1. Transmitter Propagation-Delay Timing

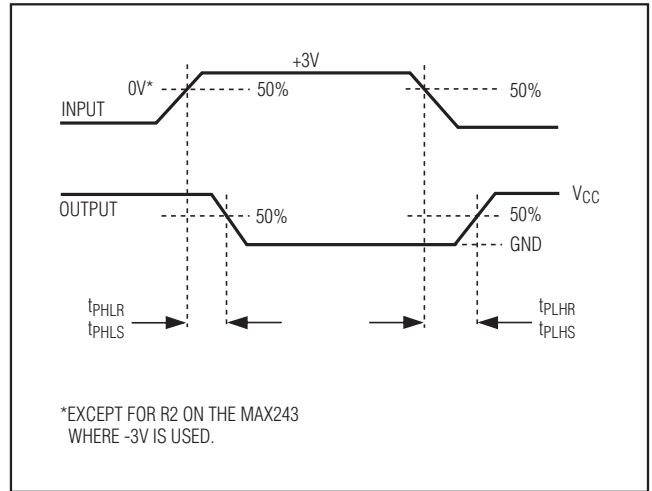

Figure 2. Receiver Propagation-Delay Timing

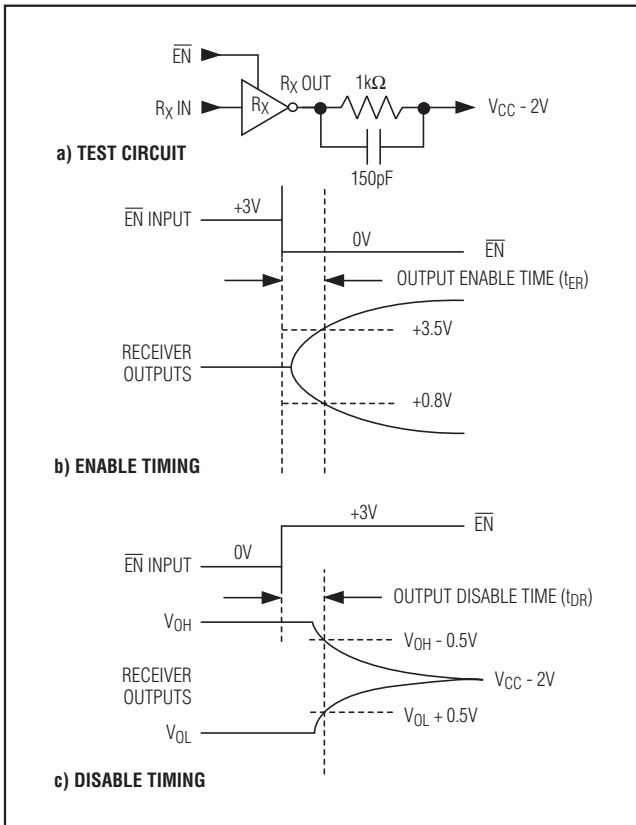

Figure 3. Receiver-Output Enable and Disable Timing

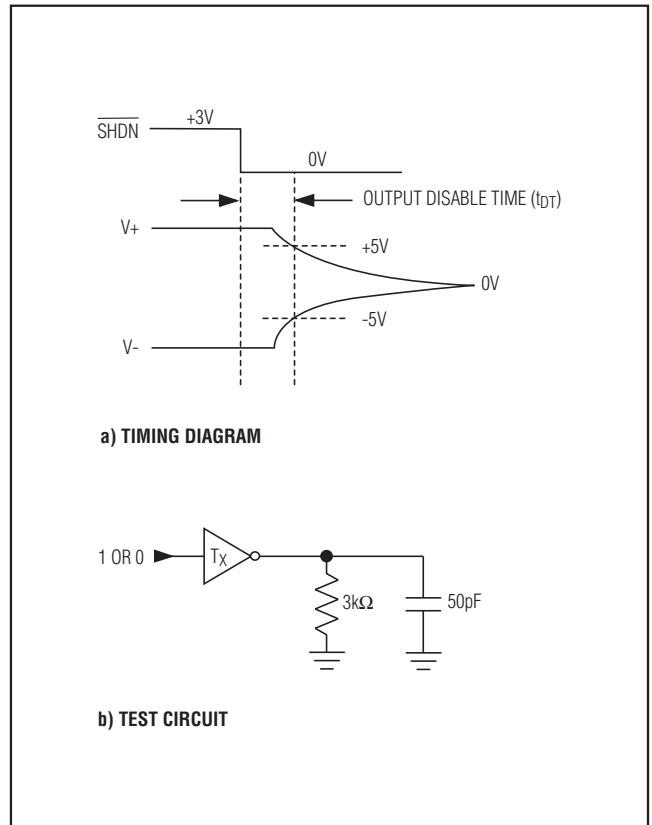

Figure 4. Transmitter-Output Disable Timing

+5V-Powered, Multichannel RS-232 Drivers/Receivers

Control Pin Configuration Tables

Table 1a. MAX245 Control Pin Configurations

| $\overline{\text{ENT}}$ | $\overline{\text{ENR}}$ | OPERATION STATUS | TRANSMITTERS | RECEIVERS |
|-------------------------|-------------------------|------------------|--------------|----------------------------|
| 0 | 0 | Normal Operation | All Active | All Active |
| 0 | 1 | Normal Operation | All Active | All High-Z |
| 1 | 0 | Shutdown | All High-Z | All Low-Power Receive Mode |
| 1 | 1 | Shutdown | All High-Z | All High-Z |

Table 1b. MAX245 Control Pin Configurations

| $\overline{\text{ENT}}$ | $\overline{\text{ENR}}$ | OPERATION STATUS | TRANSMITTERS | | RECEIVERS | |
|-------------------------|-------------------------|------------------|--------------|------------|---|---|
| | | | TA1-TA4 | TB1-TB4 | RA1-RA5 | RB1-RB5 |
| 0 | 0 | Normal Operation | All Active | All Active | All Active | All Active |
| 0 | 1 | Normal Operation | All Active | All Active | RA1-RA4 High-Z, RA5 Active | RB1-RB4 High-Z, RB5 Active |
| 1 | 0 | Shutdown | All High-Z | All High-Z | All Low-Power Receive Mode | All Low-Power Receive Mode |
| 1 | 1 | Shutdown | All High-Z | All High-Z | RA1-RA4 High-Z, RA5 Low-Power Receive Mode | RB1-RB4 High-Z, RB5 Low-Power Receive Mode |

Table 1c. MAX246 Control Pin Configurations

| $\overline{\text{ENA}}$ | $\overline{\text{ENB}}$ | OPERATION STATUS | TRANSMITTERS | | RECEIVERS | |
|-------------------------|-------------------------|------------------|--------------|------------|---|---|
| | | | TA1-TA4 | TB1-TB4 | RA1-RA5 | RB1-RB5 |
| 0 | 0 | Normal Operation | All Active | All Active | All Active | All Active |
| 0 | 1 | Normal Operation | All Active | All High-Z | All Active | RB1-RB4 High-Z, RB5 Active |
| 1 | 0 | Shutdown | All High-Z | All Active | RA1-RA4 High-Z, RA5 Active | All Active |
| 1 | 1 | Shutdown | All High-Z | All High-Z | RA1-RA4 High-Z, RA5 Low-Power Receive Mode | RB1-RB4 High-Z, RA5 Low-Power Receive Mode |

+5V-Powered, Multichannel RS-232 Drivers/Receivers

MAX220-MAX249

Table 1d. MAX247/MAX248/MAX249 Control Pin Configurations

| $\overline{\text{ENTA}}$ | $\overline{\text{ENTB}}$ | $\overline{\text{ENRA}}$ | $\overline{\text{ENRB}}$ | OPERATION STATUS | TRANSMITTERS | | | RECEIVERS | |
|--------------------------|--------------------------|--------------------------|--------------------------|------------------|--------------|------------|------------|------------------------|---|
| | | | | | MAX247 | TA1-TA4 | TB1-TB4 | RA1-RA4 | RB1-RB5 |
| | | | | | MAX248 | TA1-TA4 | TB1-TB4 | RA1-RA4 | RB1-RB4 |
| | | | | | MAX249 | TA1-TA3 | TB1-TB3 | RA1-RA5 | RB1-RB5 |
| 0 | 0 | 0 | 0 | Normal Operation | | All Active | All Active | All Active | All Active |
| 0 | 0 | 0 | 1 | Normal Operation | | All Active | All Active | All Active | All High-Z, except RB5 stays active on MAX247 |
| 0 | 0 | 1 | 0 | Normal Operation | | All Active | All Active | All High-Z | All Active |
| 0 | 0 | 1 | 1 | Normal Operation | | All Active | All Active | All High-Z | All High-Z, except RB5 stays active on MAX247 |
| 0 | 1 | 0 | 0 | Normal Operation | | All Active | All High-Z | All Active | All Active |
| 0 | 1 | 0 | 1 | Normal Operation | | All Active | All High-Z | All Active | All High-Z, except RB5 stays active on MAX247 |
| 0 | 1 | 1 | 0 | Normal Operation | | All Active | All High-Z | All High-Z | All Active |
| 0 | 1 | 1 | 1 | Normal Operation | | All Active | All High-Z | All High-Z | All High-Z, except RB5 stays active on MAX247 |
| 1 | 0 | 0 | 0 | Normal Operation | | All High-Z | All Active | All Active | All Active |
| 1 | 0 | 0 | 1 | Normal Operation | | All High-Z | All Active | All Active | All High-Z, except RB5 stays active on MAX247 |
| 1 | 0 | 1 | 0 | Normal Operation | | All High-Z | All Active | All High-Z | All Active |
| 1 | 0 | 1 | 1 | Normal Operation | | All High-Z | All Active | All High-Z | All High-Z, except RB5 stays active on MAX247 |
| 1 | 1 | 0 | 0 | Shutdown | | All High-Z | All High-Z | Low-Power Receive Mode | Low-Power Receive Mode |
| 1 | 1 | 0 | 1 | Shutdown | | All High-Z | All High-Z | Low-Power Receive Mode | All High-Z, except RB5 stays active on MAX247 |
| 1 | 1 | 1 | 0 | Shutdown | | All High-Z | All High-Z | All High-Z | Low-Power Receive Mode |
| 1 | 1 | 1 | 1 | Shutdown | | All High-Z | All High-Z | All High-Z | All High-Z, except RB5 stays active on MAX247 |

+5V-Powered, Multichannel RS-232 Drivers/Receivers

Detailed Description

The MAX220–MAX249 contain four sections: dual charge-pump DC-DC voltage converters, RS-232 drivers, RS-232 receivers, and receiver and transmitter enable control inputs.

Dual Charge-Pump Voltage Converter

The MAX220–MAX249 have two internal charge-pumps that convert +5V to $\pm 10V$ (unloaded) for RS-232 driver operation. The first converter uses capacitor C1 to double the +5V input to +10V on C3 at the V+ output. The second converter uses capacitor C2 to invert +10V to -10V on C4 at the V- output.

A small amount of power may be drawn from the +10V (V+) and -10V (V-) outputs to power external circuitry (see the *Typical Operating Characteristics* section), except on the MAX225 and MAX245–MAX247, where these pins are not available. V+ and V- are not regulated, so the output voltage drops with increasing load current. Do not load V+ and V- to a point that violates the minimum $\pm 5V$ EIA/TIA-232E driver output voltage when sourcing current from V+ and V- to external circuitry.

When using the shutdown feature in the MAX222, MAX225, MAX230, MAX235, MAX236, MAX240, MAX241, and MAX245–MAX249, avoid using V+ and V- to power external circuitry. When these parts are shut down, V- falls to 0V, and V+ falls to +5V. For applications where a +10V external supply is applied to the V+ pin (instead of using the internal charge pump to generate +10V), the C1 capacitor must not be installed and the SHDN pin must be connected to VCC. This is because V+ is internally connected to VCC in shutdown mode.

RS-232 Drivers

The typical driver output voltage swing is $\pm 8V$ when loaded with a nominal $5k\Omega$ RS-232 receiver and $V_{CC} = +5V$. Output swing is guaranteed to meet the EIA/TIA-232E and V.28 specification, which calls for $\pm 5V$ minimum driver output levels under worst-case conditions. These include a minimum $3k\Omega$ load, $V_{CC} = +4.5V$, and maximum operating temperature. Unloaded driver output voltage ranges from (V+ -1.3V) to (V- +0.5V).

Input thresholds are both TTL and CMOS compatible. The inputs of unused drivers can be left unconnected since $400k\Omega$ input pullup resistors to VCC are built in (except for the MAX220). The pullup resistors force the outputs of unused drivers low because all drivers invert. The internal input pullup resistors typically source $12\mu A$, except in shutdown mode where the pullups are disabled. Driver outputs turn off and enter a high-impedance state—where leakage current is typically microamperes (maximum $25\mu A$)—when in shutdown

mode, in three-state mode, or when device power is removed. Outputs can be driven to $\pm 15V$. The power-supply current typically drops to $8\mu A$ in shutdown mode. The MAX220 does not have pullup resistors to force the outputs of the unused drivers low. Connect unused inputs to GND or VCC.

The MAX239 has a receiver three-state control line, and the MAX223, MAX225, MAX235, MAX236, MAX240, and MAX241 have both a receiver three-state control line and a low-power shutdown control. Table 2 shows the effects of the shutdown control and receiver three-state control on the receiver outputs.

The receiver TTL/CMOS outputs are in a high-impedance, three-state mode whenever the three-state enable line is high (for the MAX225/MAX235/MAX236/MAX239–MAX241), and are also high-impedance whenever the shutdown control line is high.

When in low-power shutdown mode, the driver outputs are turned off and their leakage current is less than $1\mu A$ with the driver output pulled to ground. The driver output leakage remains less than $1\mu A$, even if the transmitter output is backdriven between 0V and ($V_{CC} + 6V$). Below -0.5V, the transmitter is diode clamped to ground with $1k\Omega$ series impedance. The transmitter is also zener clamped to approximately $V_{CC} + 6V$, with a series impedance of $1k\Omega$.

The driver output slew rate is limited to less than $30V/\mu s$ as required by the EIA/TIA-232E and V.28 specifications. Typical slew rates are $24V/\mu s$ unloaded and $10V/\mu s$ loaded with 3Ω and $2500pF$.

RS-232 Receivers

EIA/TIA-232E and V.28 specifications define a voltage level greater than 3V as a logic 0, so all receivers invert. Input thresholds are set at 0.8V and 2.4V, so receivers respond to TTL level inputs as well as EIA/TIA-232E and V.28 levels.

The receiver inputs withstand an input overvoltage up to $\pm 25V$ and provide input terminating resistors with

Table 2. Three-State Control of Receivers

| PART | SHDN | SHDN | EN | EN(R) | RECEIVERS |
|----------------------------|--------------------|---------------------|------------------|------------------|--|
| MAX223 | — | Low High High | X Low High | — | High Impedance Active High Impedance |
| MAX225 | — | — | — | Low High | High Impedance Active |
| MAX235 MAX236 MAX240 | Low Low High | — | — | Low High X | High Impedance Active High Impedance |

+5V-Powered, Multichannel RS-232 Drivers/Receivers

nominal $5k\Omega$ values. The receivers implement Type 1 interpretation of the fault conditions of V.28 and EIA/TIA-232E.

The receiver input hysteresis is typically 0.5V with a guaranteed minimum of 0.2V. This produces clear output transitions with slow-moving input signals, even with moderate amounts of noise and ringing. The receiver propagation delay is typically 600ns and is independent of input swing direction.

Low-Power Receive Mode

The low-power receive mode feature of the MAX223, MAX242, and MAX245-MAX249 puts the IC into shutdown mode but still allows it to receive information. This is important for applications where systems are periodically awakened to look for activity. Using low-power receive mode, the system can still receive a signal that will activate it on command and prepare it for communication at faster data rates. This operation conserves system power.

Negative Threshold—MAX243

The MAX243 is pin compatible with the MAX232A, differing only in that RS-232 cable fault protection is removed on one of the two receiver inputs. This means that control lines such as CTS and RTS can either be driven or left unconnected without interrupting communication. Different cables are not needed to interface with different pieces of equipment.

The input threshold of the receiver without cable fault protection is -0.8V rather than +1.4V. Its output goes positive only if the input is connected to a control line that is actively driven negative. If not driven, it defaults to the 0 or “OK to send” state. Normally, the MAX243’s other receiver (+1.4V threshold) is used for the data line (TD or RD), while the negative threshold receiver is connected to the control line (DTR, DTS, CTS, RTS, etc.).

Other members of the RS-232 family implement the optional cable fault protection as specified by EIA/TIA-232E specifications. This means a receiver output goes high whenever its input is driven negative, left unconnected, or shorted to ground. The high output tells the serial communications IC to stop sending data. To avoid this, the control lines must either be driven or connected with jumpers to an appropriate positive voltage level.

Shutdown—MAX222-MAX242

On the MAX222, MAX235, MAX236, MAX240, and MAX241, all receivers are disabled during shutdown. On the MAX223 and MAX242, two receivers continue to operate in a reduced power mode when the chip is in shutdown. Under these conditions, the propagation delay increases to about 2.5 μ s for a high-to-low input transition. When in shutdown, the receiver acts as a CMOS inverter with no hysteresis. The MAX223 and MAX242 also have a receiver output enable input (\overline{EN} for the MAX242 and EN for the MAX223) that allows receiver output control independent of \overline{SHDN} (SHDN for MAX241). With all other devices, \overline{SHDN} (SHDN for MAX241) also disables the receiver outputs.

The MAX225 provides five transmitters and five receivers, while the MAX245 provides ten receivers and eight transmitters. Both devices have separate receiver and transmitter-enable controls. The charge pumps turn off and the devices shut down when a logic high is applied to the ENT input. In this state, the supply current drops to less than 25 μ A and the receivers continue to operate in a low-power receive mode. Driver outputs enter a high-impedance state (three-state mode). On the MAX225, all five receivers are controlled by the \overline{ENR} input. On the MAX245, eight of the receiver outputs are controlled by the \overline{ENR} input, while the remaining two receivers (RA5 and RB5) are always active. RA1-RA4 and RB1-RB4 are put in a three-state mode when ENR is a logic high.

Receiver and Transmitter Enable Control Inputs

The MAX225 and MAX245-MAX249 feature transmitter and receiver enable controls.

The receivers have three modes of operation: full-speed receive (normal active), three-state (disabled), and low-power receive (enabled receivers continue to function at lower data rates). The receiver enable inputs control the full-speed receive and three-state modes. The transmitters have two modes of operation: full-speed transmit (normal active) and three-state (disabled). The transmitter enable inputs also control the shutdown mode. The device enters shutdown mode when all transmitters are disabled. Enabled receivers function in the low-power receive mode when in shutdown.

+5V-Powered, Multichannel RS-232 Drivers/Receivers

Tables 1a–1d define the control states. The MAX244 has no control pins and is not included in these tables.

The MAX246 has ten receivers and eight drivers with two control pins, each controlling one side of the device. A logic high at the A-side control input (\overline{ENA}) causes the four A-side receivers and drivers to go into a three-state mode. Similarly, the B-side control input (\overline{ENB}) causes the four B-side drivers and receivers to go into a three-state mode. As in the MAX245, one A-side and one B-side receiver (RA5 and RB5) remain active at all times. The entire device is put into shutdown mode when both the A and B sides are disabled ($\overline{ENA} = \overline{ENB} = +5V$).

The MAX247 provides nine receivers and eight drivers with four control pins. The \overline{ENRA} and \overline{ENRB} receiver enable inputs each control four receiver outputs. The \overline{ENTA} and \overline{ENTB} transmitter enable inputs each control four drivers. The ninth receiver (RB5) is always active. The device enters shutdown mode with a logic high on both \overline{ENTA} and \overline{ENTB} .

The MAX248 provides eight receivers and eight drivers with four control pins. The \overline{ENRA} and \overline{ENRB} receiver enable inputs each control four receiver outputs. The \overline{ENTA} and \overline{ENTB} transmitter enable inputs control four drivers each. This part does not have an always-active receiver. The device enters shutdown mode and transmitters go into a three-state mode with a logic high on both \overline{ENTA} and \overline{ENTB} .

The MAX249 provides ten receivers and six drivers with four control pins. The \overline{ENRA} and \overline{ENRB} receiver enable inputs each control five receiver outputs. The \overline{ENTA} and \overline{ENTB} transmitter enable inputs control three drivers each. There is no always-active receiver. The device enters shutdown mode and transmitters go into a three-state mode with a logic high on both \overline{ENTA} and \overline{ENTB} . In shutdown mode, active receivers operate in a low-power receive mode at data rates up to 20kb/s.

Applications Information

Figures 5 through 25 show pin configurations and typical operating circuits. In applications that are sensitive to power-supply noise, V_{CC} should be decoupled to ground with a capacitor of the same value as C1 and C2 connected as close as possible to the device.

+5V-Powered, Multichannel RS-232 Drivers/Receivers

MAX220-MAX249

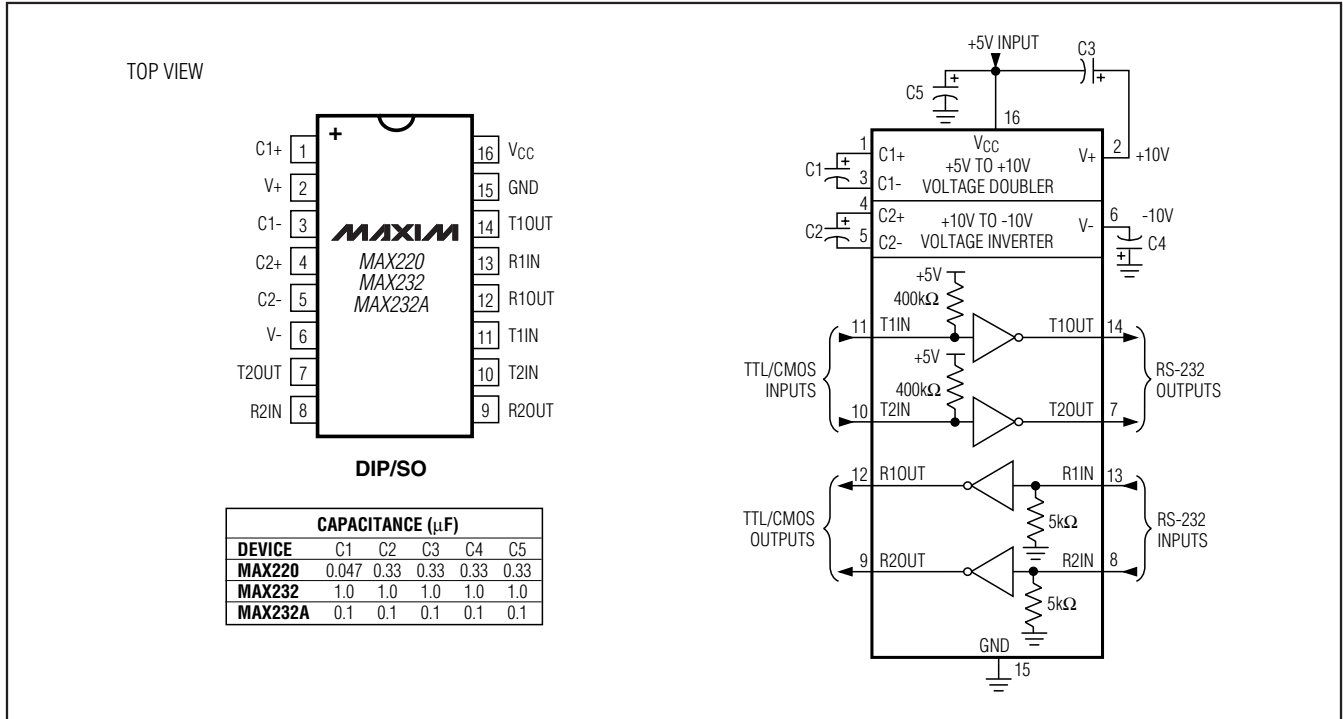

Figure 5. MAX220/MAX232/MAX232A Pin Configuration and Typical Operating Circuit

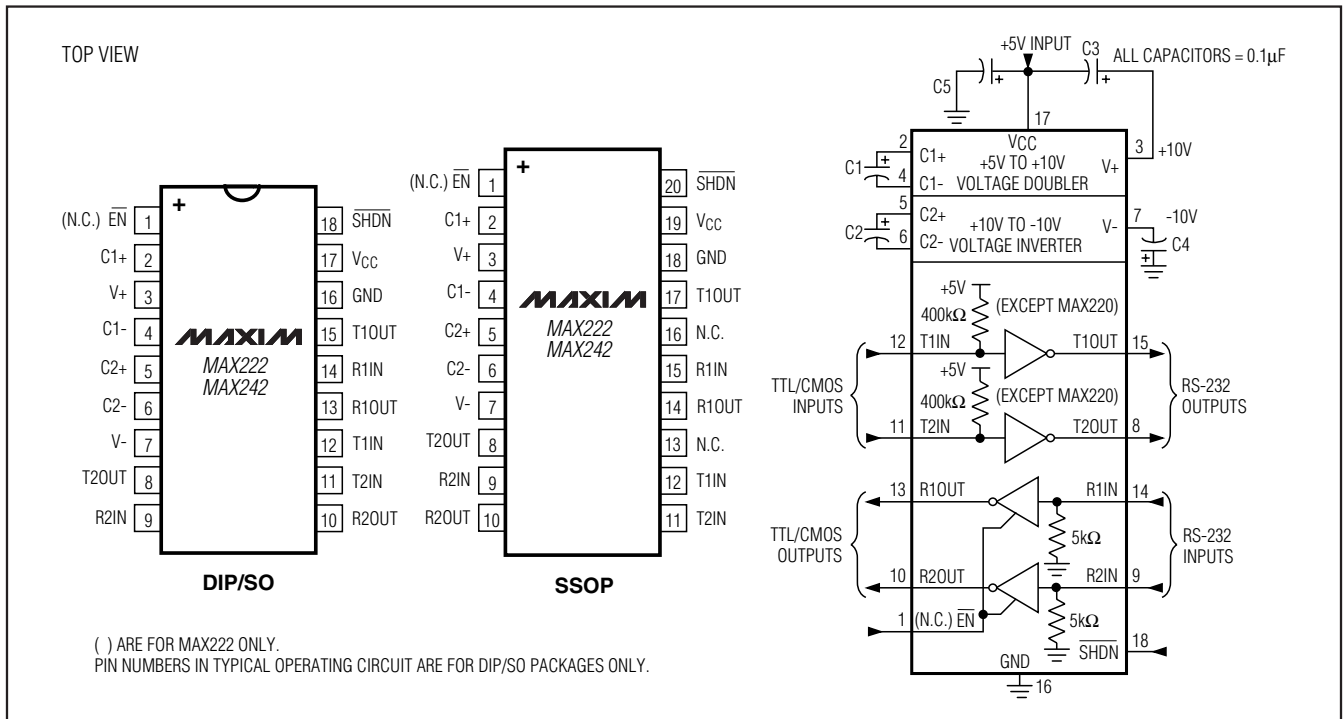
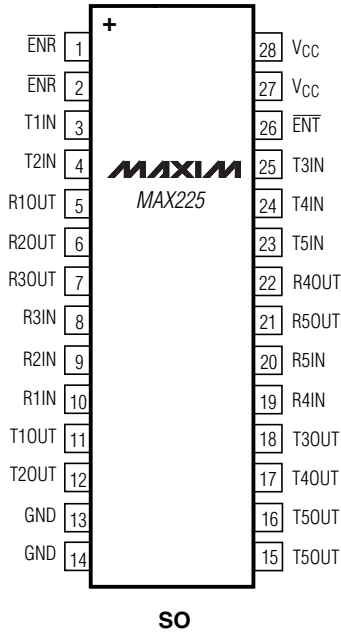

Figure 6. MAX222/MAX242 Pin Configurations and Typical Operating Circuit

+5V-Powered, Multichannel RS-232 Drivers/Receivers

TOP VIEW



MAX225 FUNCTIONAL DESCRIPTION

- 5 RECEIVERS
- 5 TRANSMITTERS
- 2 CONTROL PINS
 - 1 RECEIVER ENABLE ($\overline{\text{ENR}}$)
 - 1 TRANSMITTER ENABLE ($\overline{\text{ENT}}$)

PINS ($\overline{\text{ENR}}$, GND, V_{CC} , T5OUT) ARE INTERNALLY CONNECTED. CONNECT EITHER OR BOTH EXTERNALLY. T5OUT IS A SINGLE DRIVER.

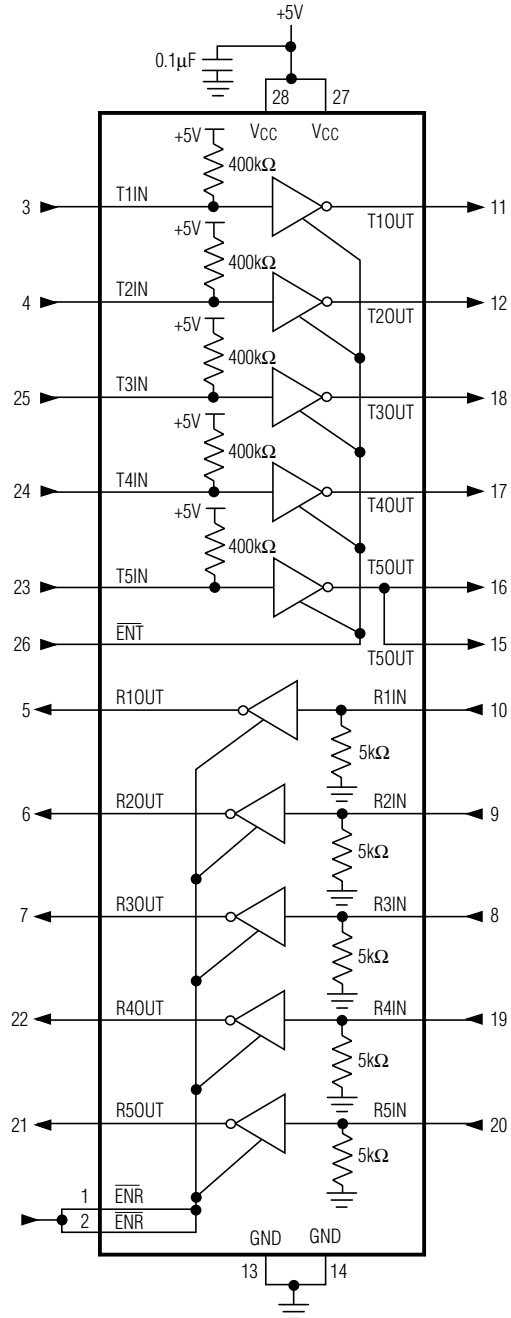

Figure 7. MAX225 Pin Configuration and Typical Operating Circuit

+5V-Powered, Multichannel RS-232 Drivers/Receivers

MAX220-MAX249

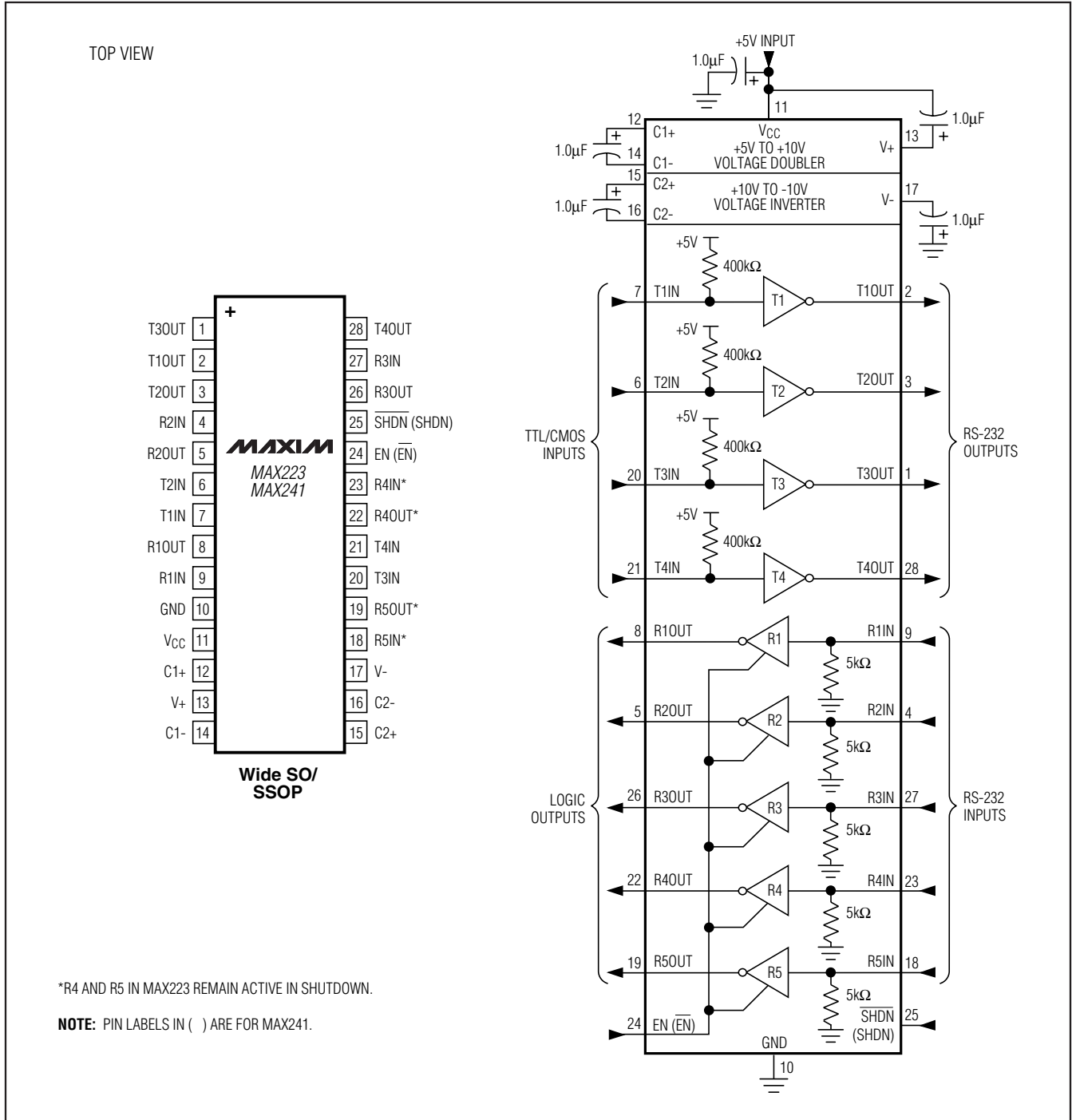

Figure 8. MAX223/MAX241 Pin Configuration and Typical Operating Circuit

+5V-Powered, Multichannel RS-232 Drivers/Receivers

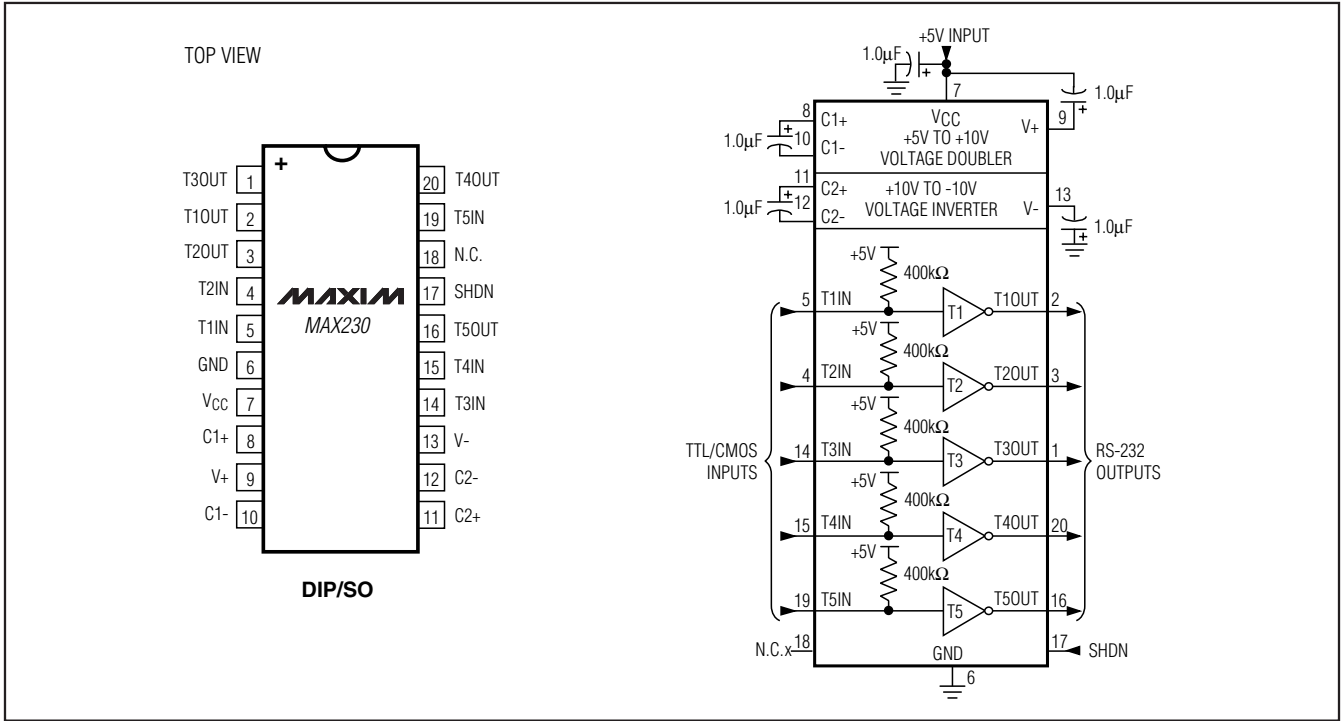

Figure 9. MAX230 Pin Configuration and Typical Operating Circuit

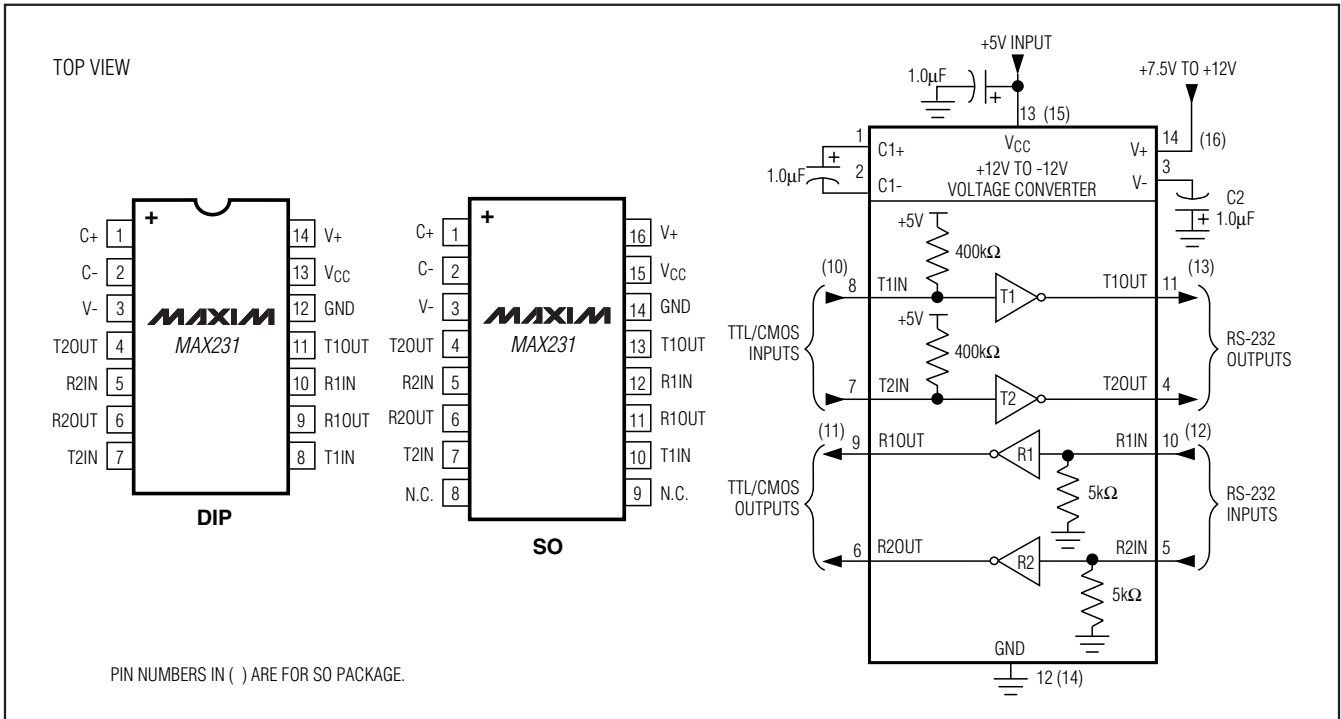

Figure 10. MAX231 Pin Configurations and Typical Operating Circuit

+5V-Powered, Multichannel RS-232 Drivers/Receivers

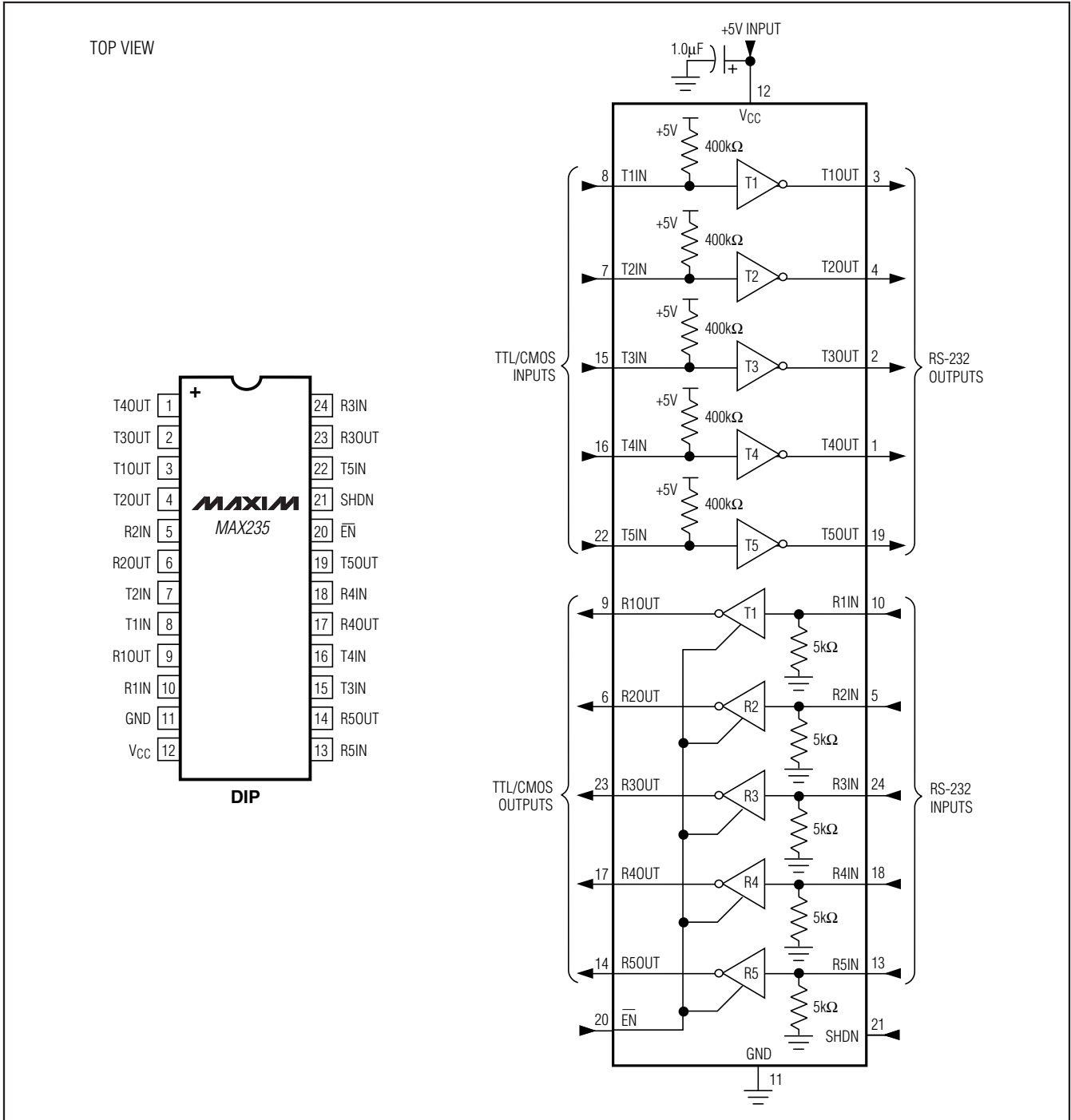

Figure 13. MAX235 Pin Configuration and Typical Operating Circuit

+5V-Powered, Multichannel RS-232 Drivers/Receivers

MAX2220-MAX249

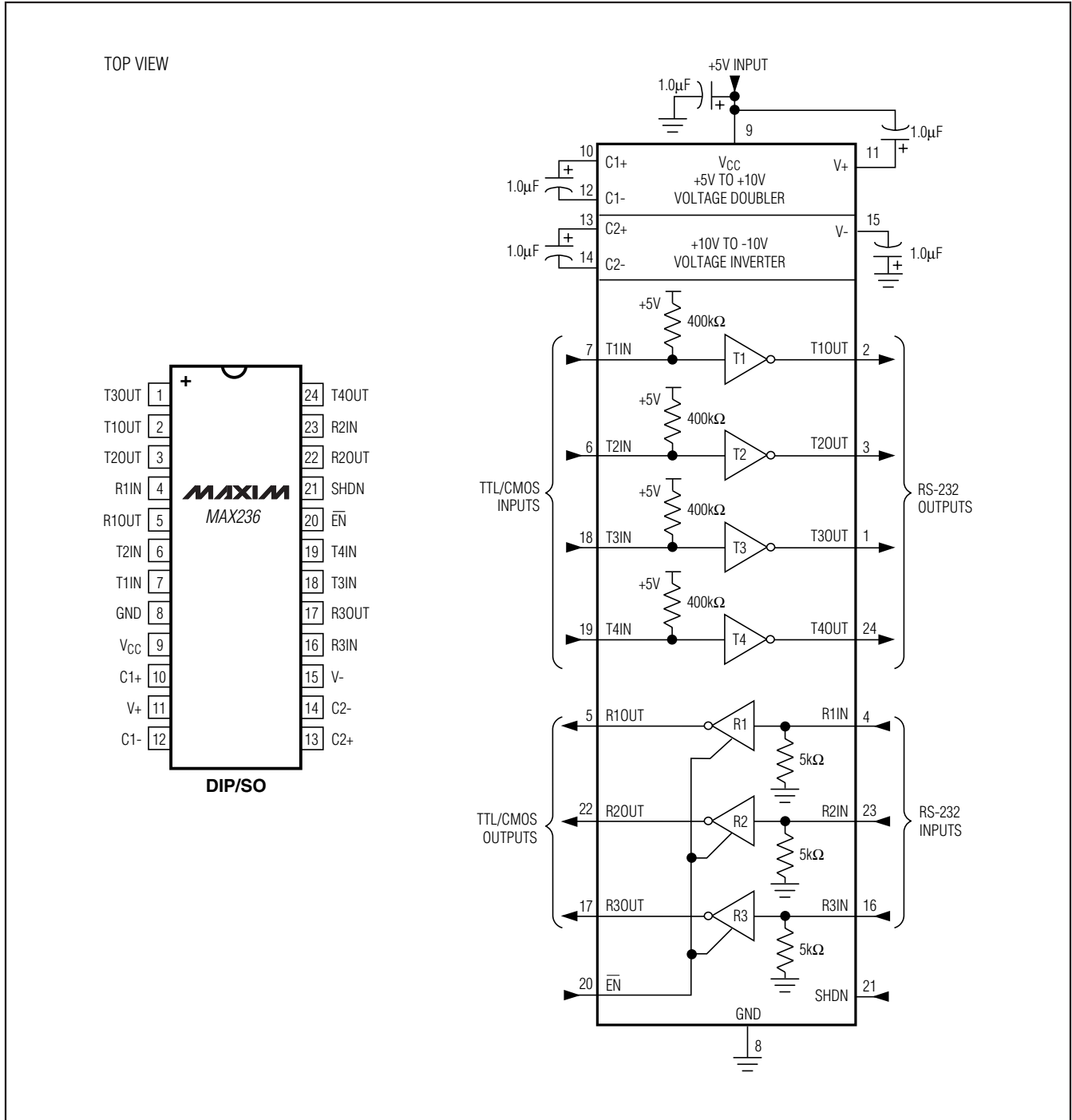

Figure 14. MAX236 Pin Configuration and Typical Operating Circuit

+5V-Powered, Multichannel RS-232 Drivers/Receivers

TOP VIEW

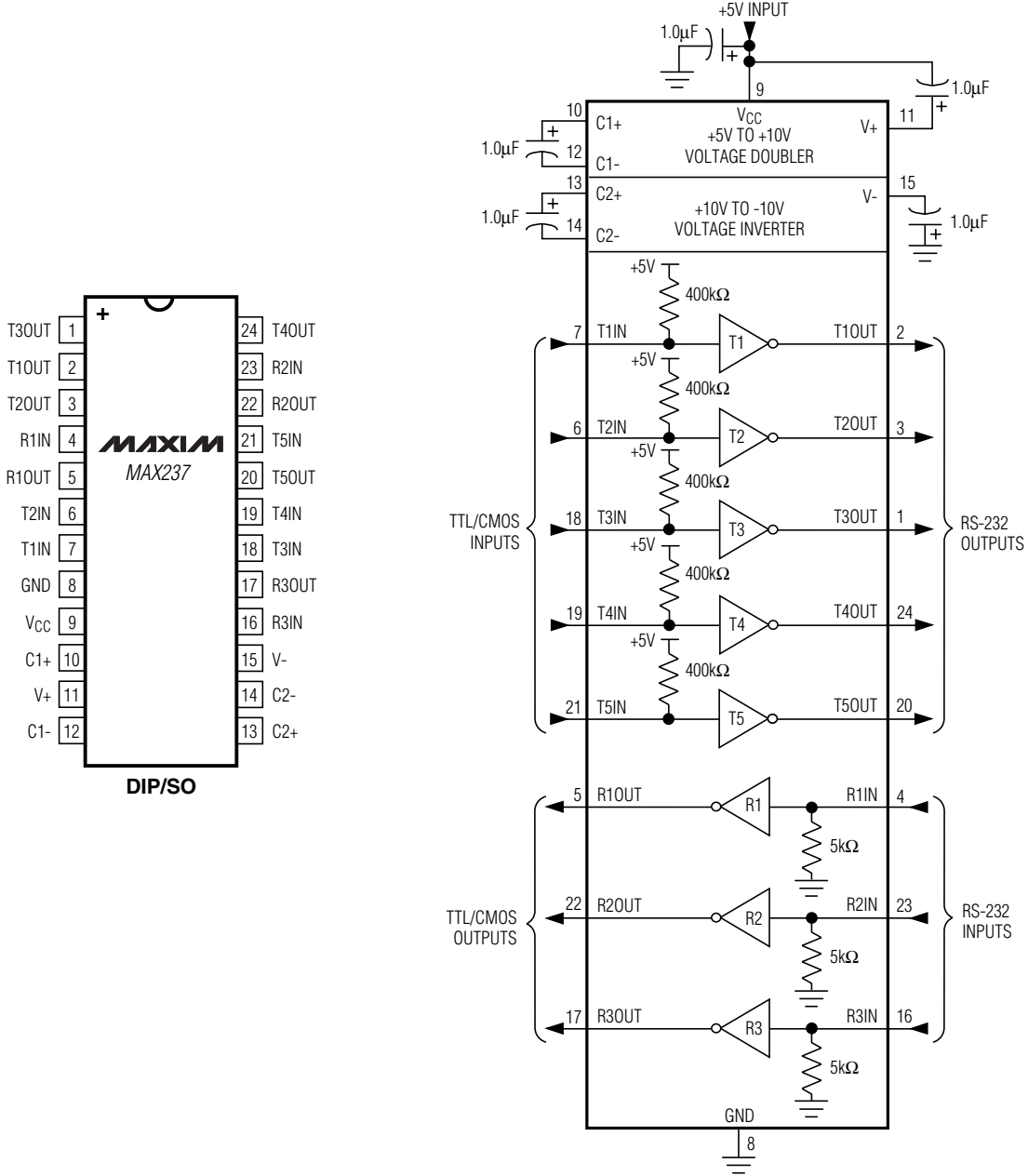

Figure 15. MAX237 Pin Configuration and Typical Operating Circuit

+5V-Powered, Multichannel RS-232 Drivers/Receivers

MAX220-MAX249

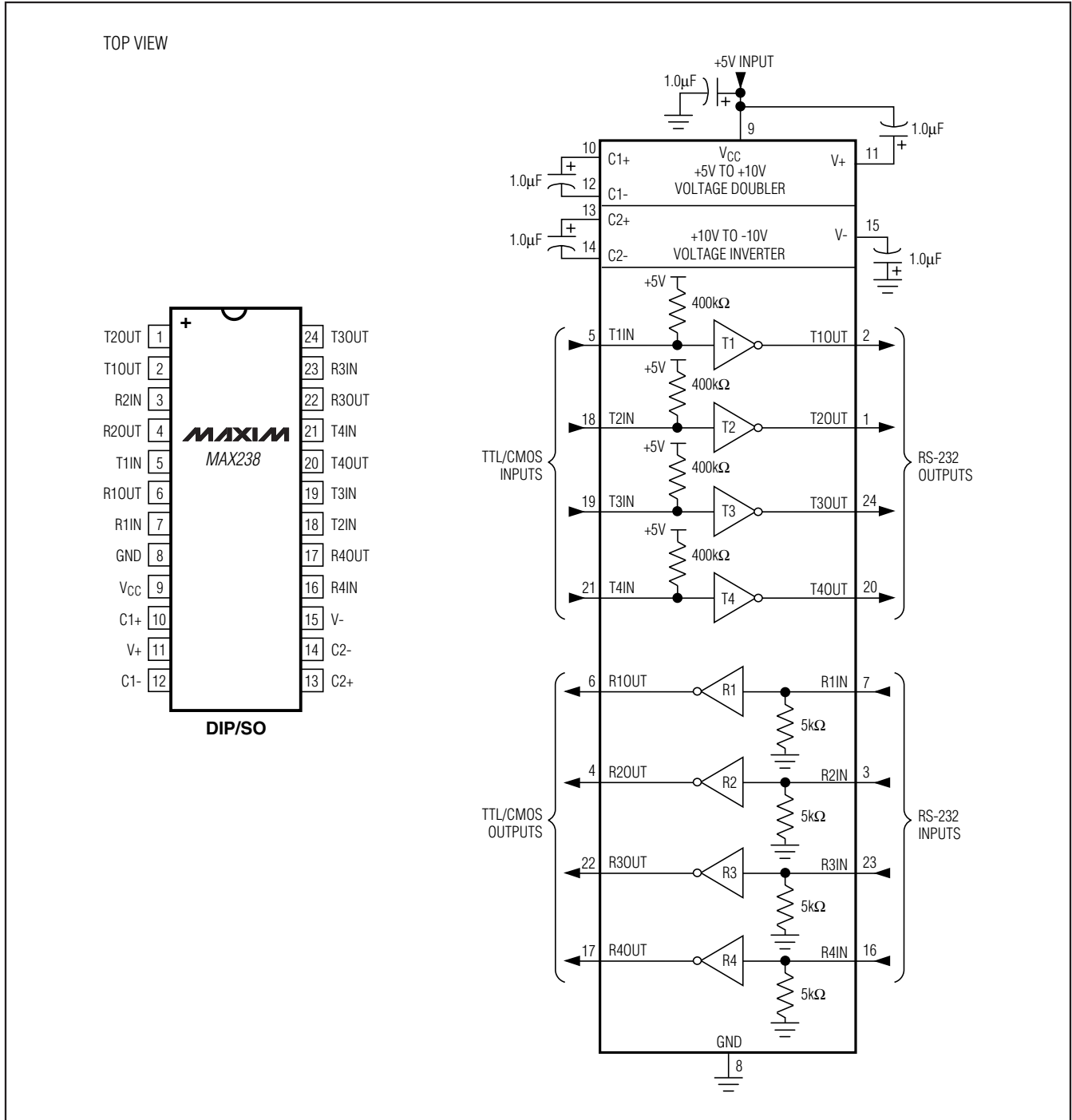
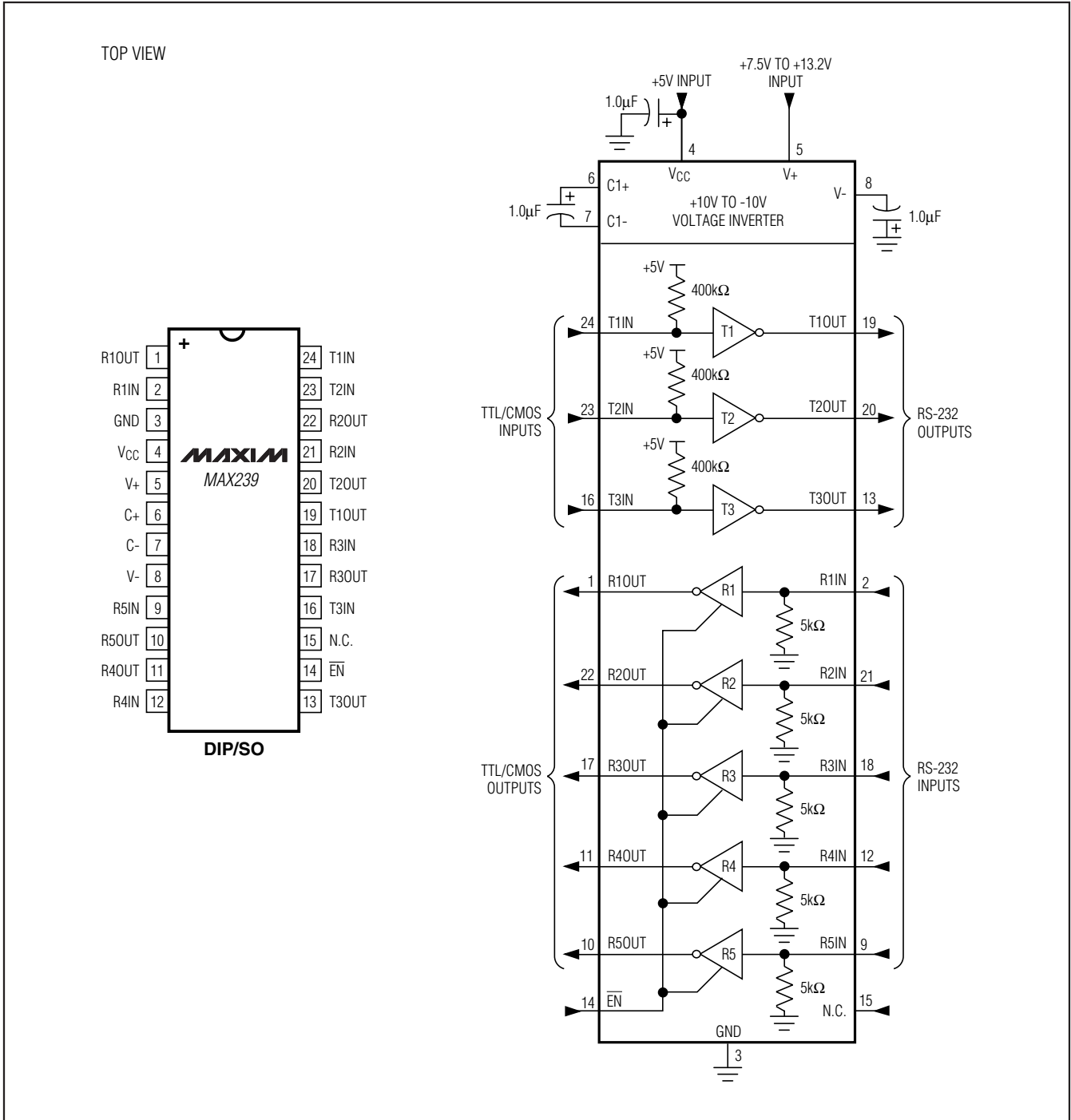

Figure 16. MAX238 Pin Configuration and Typical Operating Circuit

+5V-Powered, Multichannel RS-232 Drivers/Receivers



+5V-Powered, Multichannel RS-232 Drivers/Receivers

MAX220-MAX249

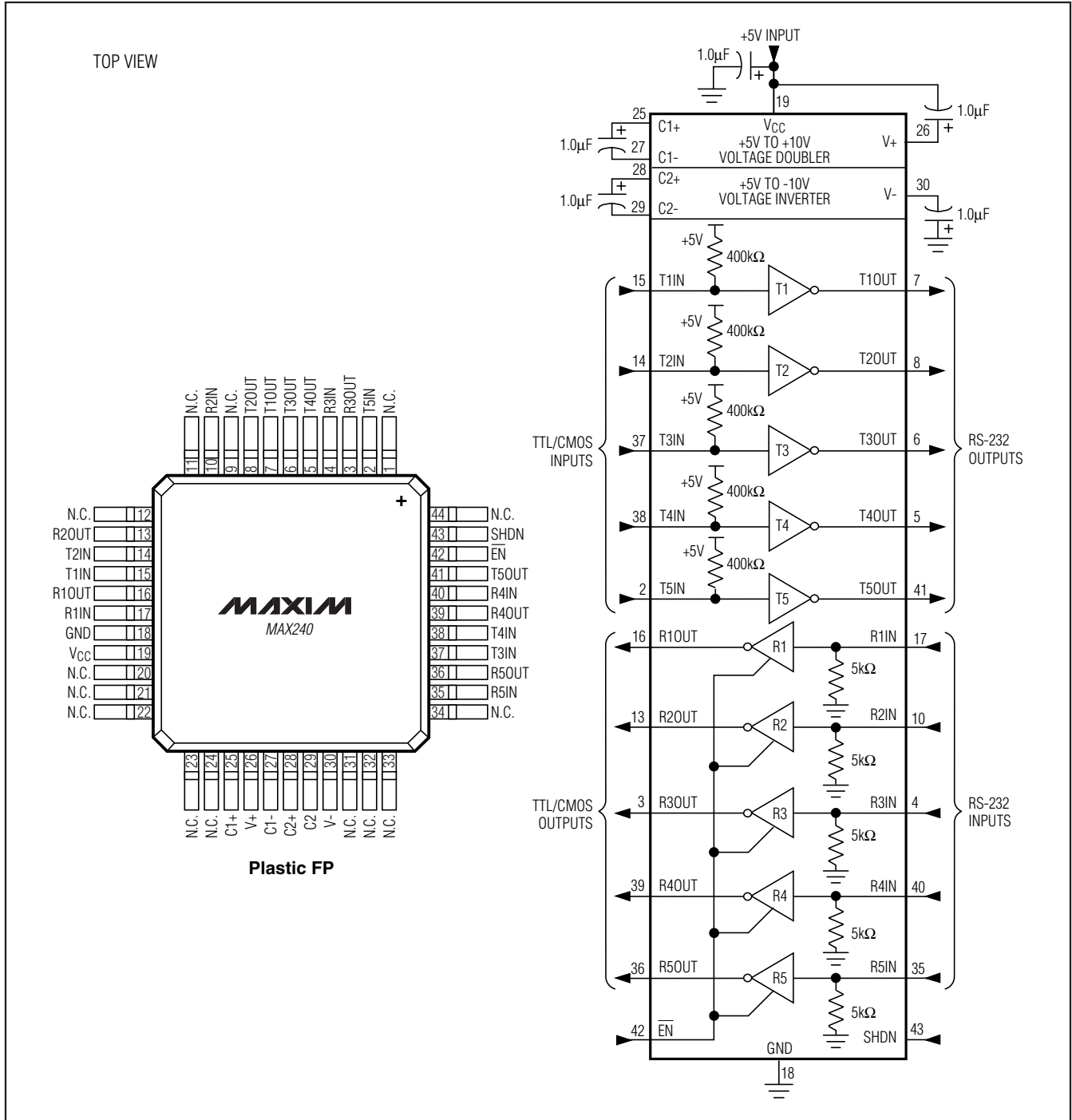

Figure 18. MAX240 Pin Configuration and Typical Operating Circuit

+5V-Powered, Multichannel RS-232 Drivers/Receivers

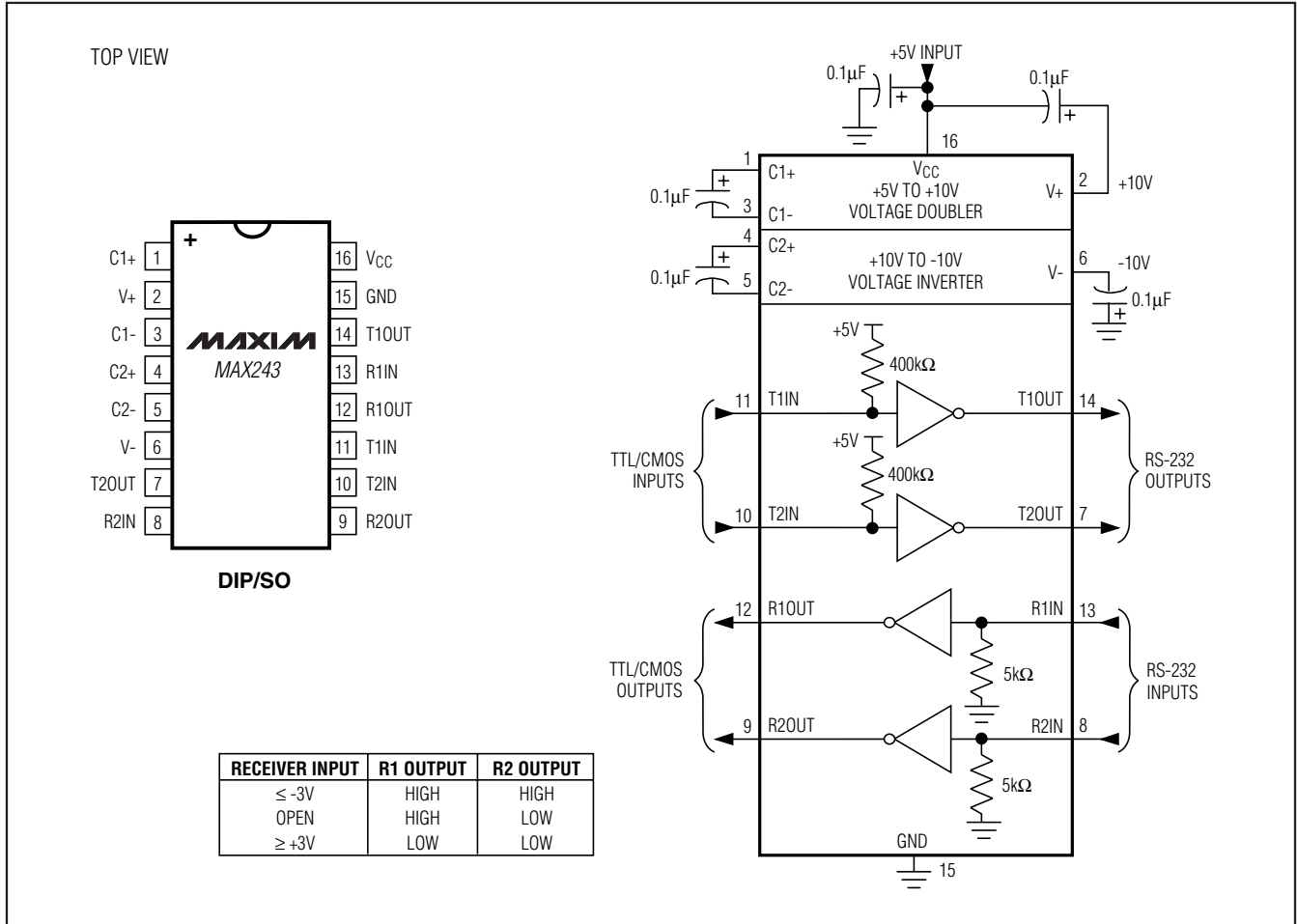

Figure 19. MAX243 Pin Configuration and Typical Operating Circuit

+5V-Powered, Multichannel RS-232 Drivers/Receivers

MAX220-MAX249

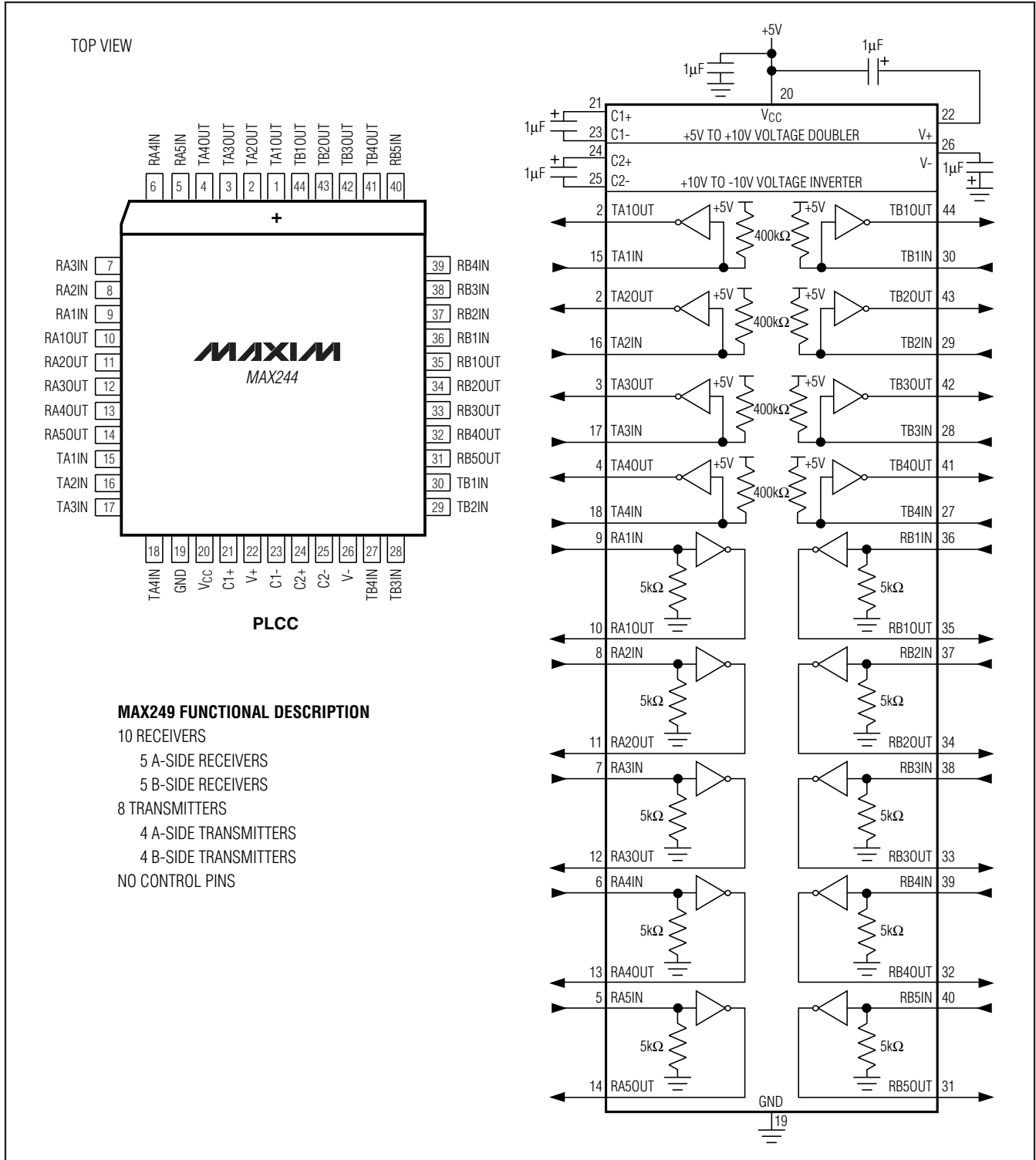

Figure 20. MAX244 Pin Configuration and Typical Operating Circuit

+5V-Powered, Multichannel RS-232 Drivers/Receivers

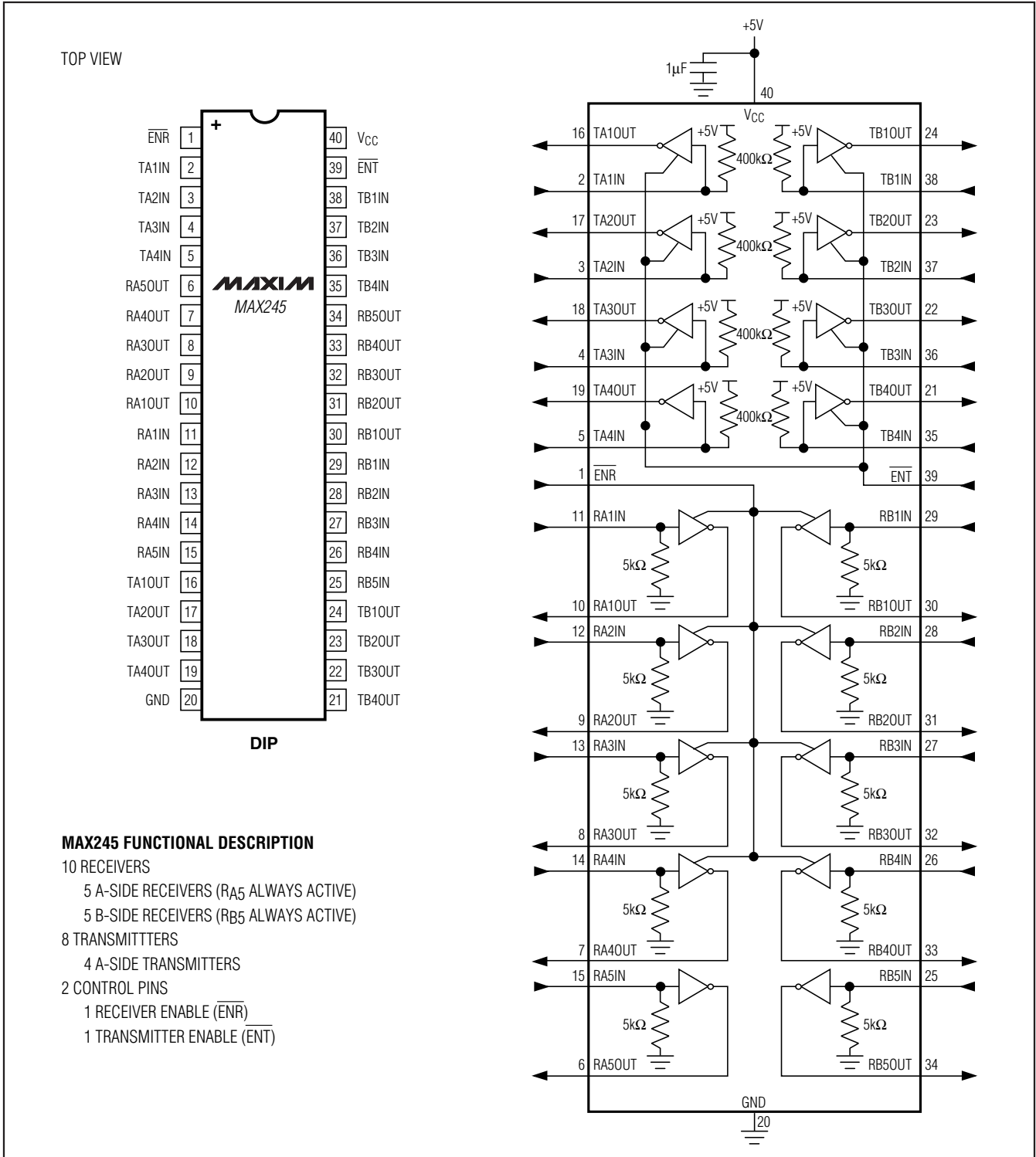

Figure 21. MAX245 Pin Configuration and Typical Operating Circuit

+5V-Powered, Multichannel RS-232 Drivers/Receivers

MAX220-MAX249

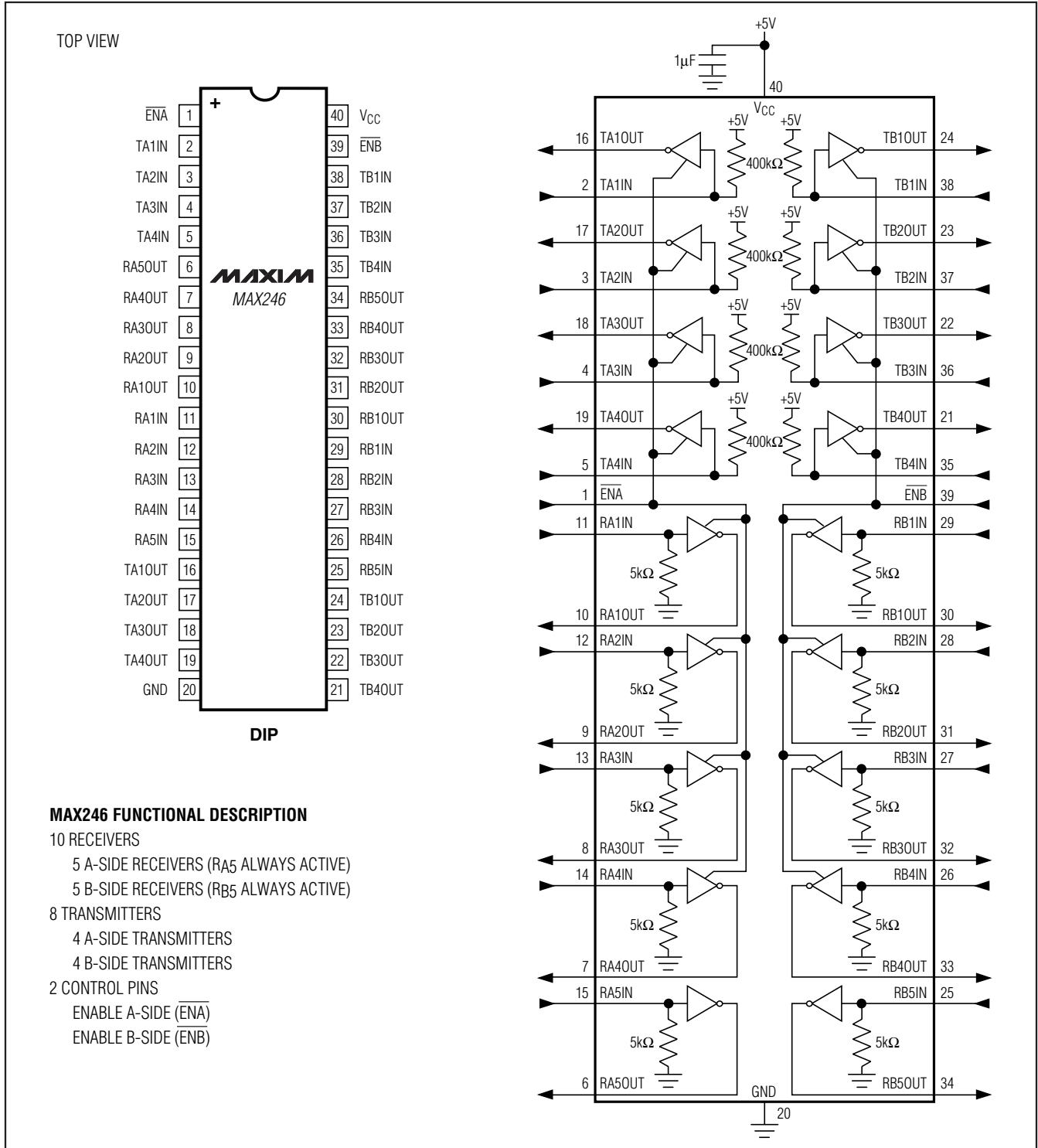

Figure 22. MAX246 Pin Configuration and Typical Operating Circuit

+5V-Powered, Multichannel RS-232 Drivers/Receivers

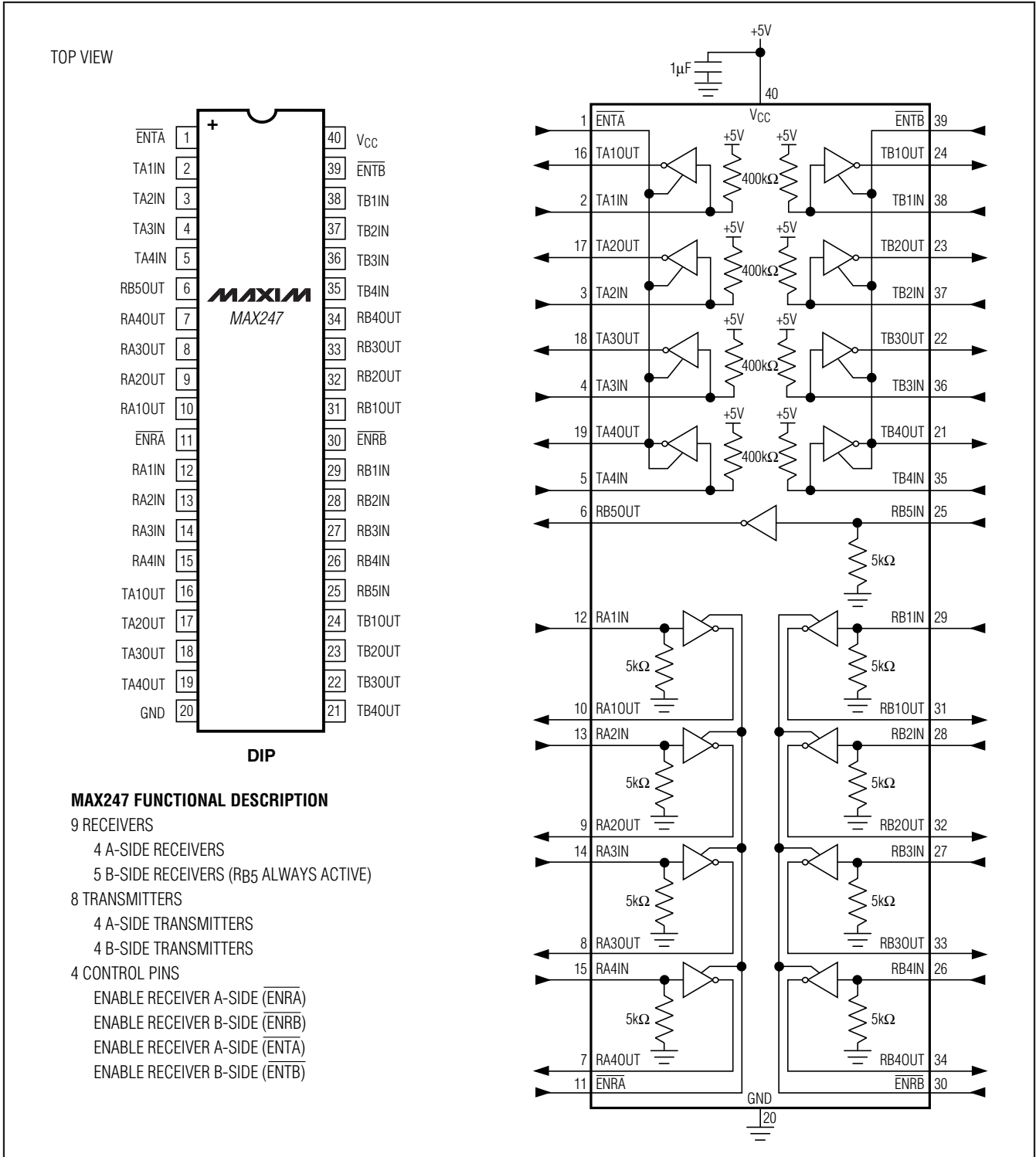

Figure 23. MAX247 Pin Configuration and Typical Operating Circuit

+5V-Powered, Multichannel RS-232 Drivers/Receivers

MAX220-MAX249

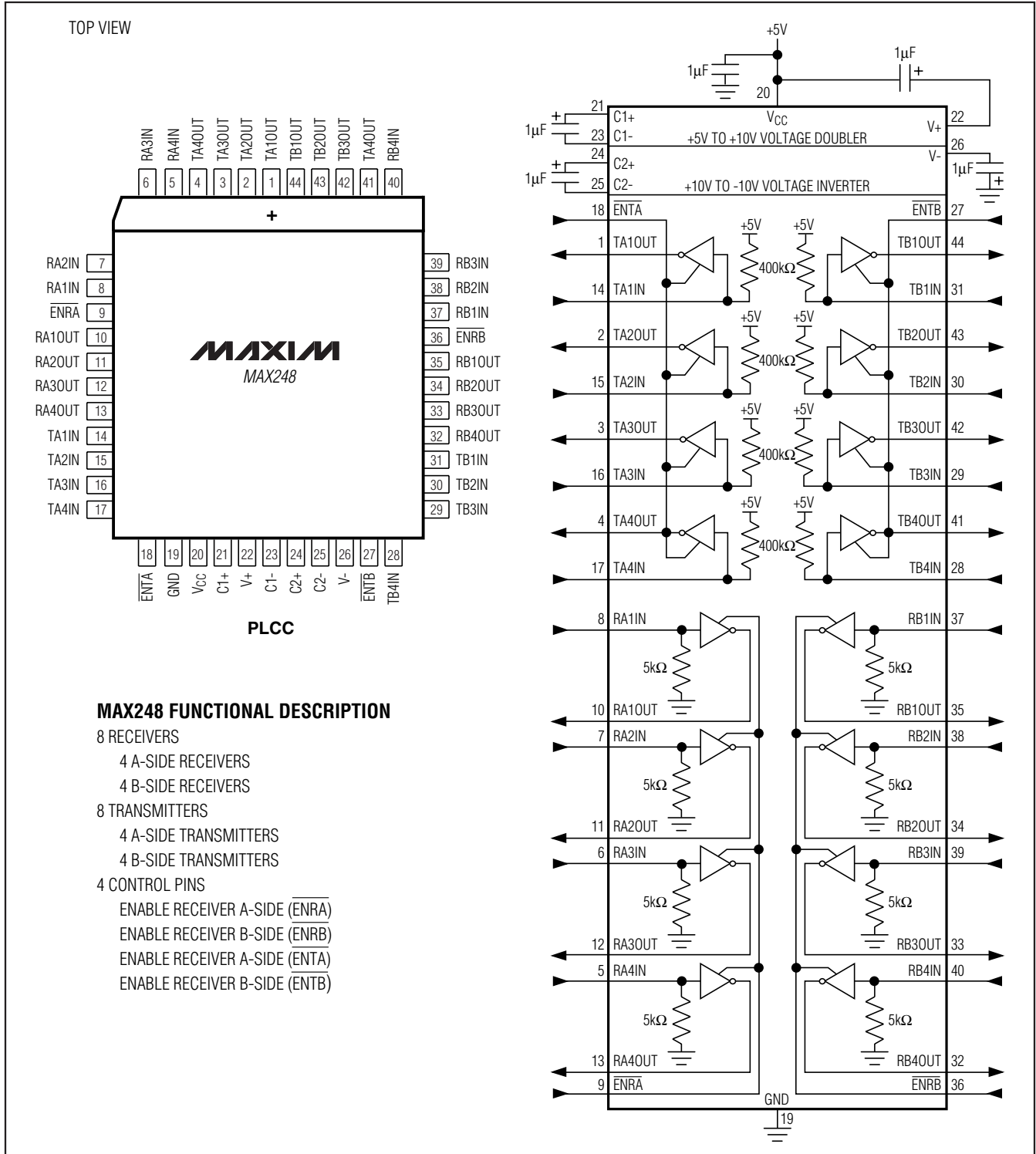

Figure 24. MAX248 Pin Configuration and Typical Operating Circuit

+5V-Powered, Multichannel RS-232 Drivers/Receivers

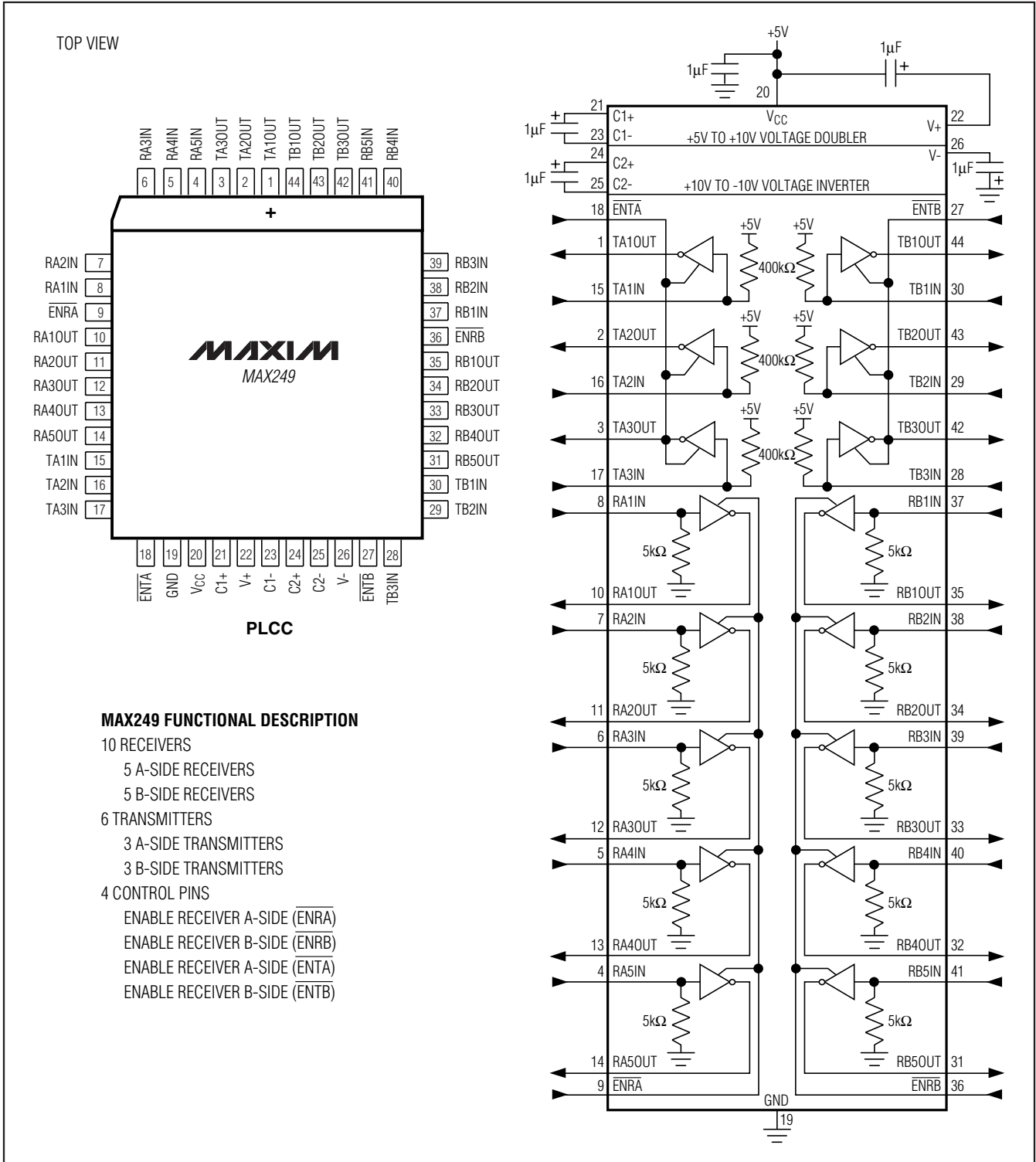

Figure 25. MAX249 Pin Configuration and Typical Operating Circuit

+5V-Powered, Multichannel RS-232 Drivers/Receivers

Ordering Information (continued)

MAX220-MAX249

| PART | TEMP RANGE | PIN-PACKAGE |
|---------------------|-----------------|----------------|
| MAX222 CPN+ | 0°C to +70°C | 18 Plastic DIP |
| MAX222CWN+ | 0°C to +70°C | 18 Wide SO |
| MAX222C/D | 0°C to +70°C | Dice* |
| MAX222EPN+ | -40°C to +85°C | 18 Plastic DIP |
| MAX222EWN+ | -40°C to +85°C | 18 Wide SO |
| MAX222EJN | -40°C to +85°C | 18 CERDIP |
| MAX222MJN | -55°C to +125°C | 18 CERDIP |
| MAX223 CAI+ | 0°C to +70°C | 28 SSOP |
| MAX223CWI+ | 0°C to +70°C | 28 Wide SO |
| MAX223C/D | 0°C to +70°C | Dice* |
| MAX223EAI+ | -40°C to +85°C | 28 SSOP |
| MAX223EWI+ | -40°C to +85°C | 28 Wide SO |
| MAX225 CWI+ | 0°C to +70°C | 28 Wide SO |
| MAX225EWI+ | -40°C to +85°C | 28 Wide SO |
| MAX230 CPP+ | 0°C to +70°C | 20 Plastic DIP |
| MAX230CWP+ | 0°C to +70°C | 20 Wide SO |
| MAX230C/D | 0°C to +70°C | Dice* |
| MAX230EPP+ | -40°C to +85°C | 20 Plastic DIP |
| MAX230EWP+ | -40°C to +85°C | 20 Wide SO |
| MAX230EJP | -40°C to +85°C | 20 CERDIP |
| MAX230MJP | -55°C to +125°C | 20 CERDIP |
| MAX231 CPD+ | 0°C to +70°C | 14 Plastic DIP |
| MAX231CWE+ | 0°C to +70°C | 16 Wide SO |
| MAX231CJD | 0°C to +70°C | 14 CERDIP |
| MAX231C/D | 0°C to +70°C | Dice* |
| MAX231EPD+ | -40°C to +85°C | 14 Plastic DIP |
| MAX231EWE+ | -40°C to +85°C | 16 Wide SO |
| MAX231EJD | -40°C to +85°C | 14 CERDIP |
| MAX231MJD | -55°C to +125°C | 14 CERDIP |
| MAX232 CPE+ | 0°C to +70°C | 16 Plastic DIP |
| MAX232CSE+ | 0°C to +70°C | 16 Narrow SO |
| MAX232CWE+ | 0°C to +70°C | 16 Wide SO |
| MAX232C/D | 0°C to +70°C | Dice* |
| MAX232EPE+ | -40°C to +85°C | 16 Plastic DIP |
| MAX232ESE+ | -40°C to +85°C | 16 Narrow SO |
| MAX232EWE+ | -40°C to +85°C | 16 Wide SO |
| MAX232EJE | -40°C to +85°C | 16 CERDIP |
| MAX232MJE | -55°C to +125°C | 16 CERDIP |
| MAX232MLP+ | -55°C to +125°C | 20 LCC |
| MAX232A CPE+ | 0°C to +70°C | 16 Plastic DIP |
| MAX232ACSE+ | 0°C to +70°C | 16 Narrow SO |
| MAX232ACWE+ | 0°C to +70°C | 16 Wide SO |

| PART | TEMP RANGE | PIN-PACKAGE |
|---------------------|-----------------|-----------------------|
| MAX232AC/D | 0°C to +70°C | Dice* |
| MAX232AEPE+ | -40°C to +85°C | 16 Plastic DIP |
| MAX232AESE+ | -40°C to +85°C | 16 Narrow SO |
| MAX232AEWE+ | -40°C to +85°C | 16 Wide SO |
| MAX232AEJE | -40°C to +85°C | 16 CERDIP |
| MAX232AMJE | -55°C to +125°C | 16 CERDIP |
| MAX232AMLP+ | -55°C to +125°C | 20 LCC |
| MAX233 CPP+ | 0°C to +70°C | 20 Plastic DIP |
| MAX233EPP+ | -40°C to +85°C | 20 Plastic DIP |
| MAX233A CPP+ | 0°C to +70°C | 20 Plastic DIP |
| MAX233ACWP+ | 0°C to +70°C | 20 Wide SO |
| MAX233AEPP+ | -40°C to +85°C | 20 Plastic DIP |
| MAX233AEWP+ | -40°C to +85°C | 20 Wide SO |
| MAX234 CPE+ | 0°C to +70°C | 16 Plastic DIP |
| MAX234CWE+ | 0°C to +70°C | 16 Wide SO |
| MAX234C/D | 0°C to +70°C | Dice* |
| MAX234EPE+ | -40°C to +85°C | 16 Plastic DIP |
| MAX234EWE+ | -40°C to +85°C | 16 Wide SO |
| MAX234EJE | -40°C to +85°C | 16 CERDIP |
| MAX234MJE | -55°C to +125°C | 16 CERDIP |
| MAX235 CPG+ | 0°C to +70°C | 24 Wide Plastic DIP |
| MAX235EPG+ | -40°C to +85°C | 24 Wide Plastic DIP |
| MAX235EDG | -40°C to +85°C | 24 Ceramic SB |
| MAX235MDG | -55°C to +125°C | 24 Ceramic SB |
| MAX236 CNG+ | 0°C to +70°C | 24 Narrow Plastic DIP |
| MAX236CWG+ | 0°C to +70°C | 24 Wide SO |
| MAX236C/D | 0°C to +70°C | Dice* |
| MAX236ENG+ | -40°C to +85°C | 24 Narrow Plastic DIP |
| MAX236EWG+ | -40°C to +85°C | 24 Wide SO |
| MAX236ERG | -40°C to +85°C | 24 Narrow CERDIP |
| MAX236MRG | -55°C to +125°C | 24 Narrow CERDIP |
| MAX237 CNG+ | 0°C to +70°C | 24 Narrow Plastic DIP |
| MAX237CWG+ | 0°C to +70°C | 24 Wide SO |
| MAX237C/D | 0°C to +70°C | Dice* |
| MAX237ENG+ | -40°C to +85°C | 24 Narrow Plastic DIP |
| MAX237EWG+ | -40°C to +85°C | 24 Wide SO |
| MAX237ERG | -40°C to +85°C | 24 Narrow CERDIP |
| MAX237MRG | -55°C to +125°C | 24 Narrow CERDIP |
| MAX238 CNG+ | 0°C to +70°C | 24 Narrow Plastic DIP |
| MAX238CWG+ | 0°C to +70°C | 24 Wide SO |
| MAX238C/D | 0°C to +70°C | Dice* |

+ Denotes a lead(Pb)-free/RoHS-compliant package.

* Contact factory for dice specifications.

+5V-Powered, Multichannel RS-232 Drivers/Receivers

Ordering Information (continued)

| PART | TEMP RANGE | PIN-PACKAGE |
|--------------------|-----------------|-----------------------|
| MAX238ENG+ | -40°C to +85°C | 24 Narrow Plastic DIP |
| MAX238EWG+ | -40°C to +85°C | 24 Wide SO |
| MAX238ERG | -40°C to +85°C | 24 Narrow CERDIP |
| MAX238MRG | -55°C to +125°C | 24 Narrow CERDIP |
| MAX239 CNG+ | 0°C to +70°C | 24 Narrow Plastic DIP |
| MAX239CWG+ | 0°C to +70°C | 24 Wide SO |
| MAX239C/D | 0°C to +70°C | Dice* |
| MAX239ENG+ | -40°C to +85°C | 24 Narrow Plastic DIP |
| MAX239EWG+ | -40°C to +85°C | 24 Wide SO |
| MAX239ERG | -40°C to +85°C | 24 Narrow CERDIP |
| MAX239MRG | -55°C to +125°C | 24 Narrow CERDIP |
| MAX240 CMH+ | 0°C to +70°C | 44 Plastic FP |
| MAX240C/D | 0°C to +70°C | Dice* |
| MAX241 CAI+ | 0°C to +70°C | 28 SSOP |
| MAX241CWI+ | 0°C to +70°C | 28 Wide SO |
| MAX241C/D | 0°C to +70°C | Dice* |
| MAX241EAI+ | -40°C to +85°C | 28 SSOP |
| MAX241EWI+ | -40°C to +85°C | 28 Wide SO |
| MAX242 CAP+ | 0°C to +70°C | 20 SSOP |
| MAX242CPN+ | 0°C to +70°C | 18 Plastic DIP |
| MAX242CWN+ | 0°C to +70°C | 18 Wide SO |
| MAX242C/D | 0°C to +70°C | Dice* |
| MAX242EPN+ | -40°C to +85°C | 18 Plastic DIP |
| MAX242EWN+ | -40°C to +85°C | 18 Wide SO |
| MAX242EJN | -40°C to +85°C | 18 CERDIP |
| MAX242MJN | -55°C to +125°C | 18 CERDIP |

| PART | TEMP RANGE | PIN-PACKAGE |
|--------------------|-----------------|----------------|
| MAX243 CPE+ | 0°C to +70°C | 16 Plastic DIP |
| MAX243CSE+ | 0°C to +70°C | 16 Narrow SO |
| MAX243CWE+ | 0°C to +70°C | 16 Wide SO |
| MAX243C/D | 0°C to +70°C | Dice* |
| MAX243EPE+ | -40°C to +85°C | 16 Plastic DIP |
| MAX243ESE+ | -40°C to +85°C | 16 Narrow SO |
| MAX243EWE+ | -40°C to +85°C | 16 Wide SO |
| MAX243EJE | -40°C to +85°C | 16 CERDIP |
| MAX243MJE | -55°C to +125°C | 16 CERDIP |
| MAX244 CQH+ | 0°C to +70°C | 44 PLCC |
| MAX244C/D | 0°C to +70°C | Dice* |
| MAX244EQH+ | -40°C to +85°C | 44 PLCC |
| MAX245 CPL+ | 0°C to +70°C | 40 Plastic DIP |
| MAX245C/D | 0°C to +70°C | Dice* |
| MAX245EPL+ | -40°C to +85°C | 40 Plastic DIP |
| MAX246 CPL+ | 0°C to +70°C | 40 Plastic DIP |
| MAX246C/D | 0°C to +70°C | Dice* |
| MAX246EPL+ | -40°C to +85°C | 40 Plastic DIP |
| MAX247 CPL+ | 0°C to +70°C | 40 Plastic DIP |
| MAX247C/D | 0°C to +70°C | Dice* |
| MAX247EPL+ | -40°C to +85°C | 40 Plastic DIP |
| MAX248 CQH+ | 0°C to +70°C | 44 PLCC |
| MAX248C/D | 0°C to +70°C | Dice* |
| MAX248EQH+ | -40°C to +85°C | 44 PLCC |
| MAX249 CQH+ | 0°C to +70°C | 44 PLCC |
| MAX249EQH+ | -40°C to +85°C | 44 PLCC |

+Denotes a lead(Pb)-free/RoHS-compliant package.

*Contact factory for dice specifications.

+5V-Powered, Multichannel RS-232 Drivers/Receivers

MAX220-MAX249

Package Information

For the latest package outline information and land patterns, go to www.maxim-ic.com/packages. Note that a "+", "#", or "-" in the package code indicates RoHS status only. Package drawings may show a different suffix character, but the drawing pertains to the package regardless of RoHS status.

| PACKAGE TYPE | PACKAGE CODE | OUTLINE NO. | LAND PATTERN NO. |
|--------------|--------------|-------------------------|-------------------------|
| 14 PDIP | P14+3 | 21-0043 | — |
| 16 PDIP | P16+1 | | |
| 16 PDIP | P16+2 | | |
| 16 PDIP | P16+3 | | |
| 18 PDIP | P18+5 | | |
| 20 PDIP | P20+3 | | |
| 20 PDIP | P20M+1 | | |
| 24 PDIP | N24+3 | | |
| 24 PDIP | P24M+1 | 21-0044 | — |
| 28 PDIP | P28+2 | | |
| 40 PDIP | P40+1 | | |
| 40 PDIP | P40M+2 | | |
| 14 CERDIP | J14-3 | 21-0045 | — |
| 16 CERDIP | J16-3 | | |
| 18 CERDIP | J18-2 | | |
| 20 CERDIP | J20-2 | | |
| 24 CERDIP | R24-4 | | |
| 16 SO(N) | S16+3 | 21-0041 | 90-0097 |
| 16 SO(N) | S16+5 | 21-0042 | — |
| 16 SO(W) | W16+1 | | |
| 16 SO(W) | W16+2 | | |
| 16 SO(W) | W16+3 | | |
| 18 SO(W) | W18+1 | | |
| 20 SO(W) | W20+3 | | |
| 20 SO(W) | W20M+1 | | |
| 24 SO(W) | W24+2 | | |
| 28 SO(W) | W28+1 | | |
| 28 SO(W) | W28+2 | | |
| 28 SO(W) | W28M+1 | 21-0056 | 90-0107 |
| 20 LCC | L20+3 | | 90-0181 |
| 20 SSOP | A20+1 | | 90-0108 |
| 24 SSOP | A24+2 | | 90-0182 |
| 28 SSOP | A28+1 | | 90-0109 |
| 16 TSSOP | U16+1 | 21-0013 | — |
| 16 FPCK | F16-3 | 21-0826 | 90-0177 |
| 44 MQFP | M44+5 | 21-0049 | 90-0094 |
| 44 PLCC | Q44+1 | | 90-0110 |
| 44 PLCC | Q44+2 | | 90-0095 |
| | | | 90-0117 |
| | | | — |
| | | | 90-0169 |
| | | | 90-0236 |

+5V-Powered, Multichannel RS-232 Drivers/Receivers

Revision History

| REVISION NUMBER | REVISION DATE | DESCRIPTION | PAGES CHANGED |
|-----------------|---------------|---|---------------|
| 15 | 1/06 | Added part information to the lead temperature in the <i>Absolute Maximum Ratings</i> sections | 2, 5, 8 |
| 16 | 7/10 | Changed multiple packages to lead-free versions; updated/added notes 3, 4, 5, 7, and 8 to the <i>Electrical Characteristics</i> table; removed incorrect subscripting from all pin names in the <i>Electrical Characteristics</i> table and <i>Pin Configurations</i> | 1, 2-9, 17-36 |

Maxim cannot assume responsibility for use of any circuitry other than circuitry entirely embodied in a Maxim product. No circuit patent licenses are implied. Maxim reserves the right to change the circuitry and specifications without notice at any time.

38 **Maxim Integrated Products, 120 San Gabriel Drive, Sunnyvale, CA 94086 408-737-7600**

Компания «Океан Электроники» предлагает заключение долгосрочных отношений при поставках импортных электронных компонентов на взаимовыгодных условиях!

Наши преимущества:

- Поставка оригинальных импортных электронных компонентов напрямую с производств Америки, Европы и Азии, а так же с крупнейших складов мира;
- Широкая линейка поставок активных и пассивных импортных электронных компонентов (более 30 млн. наименований);
- Поставка сложных, дефицитных, либо снятых с производства позиций;
- Оперативные сроки поставки под заказ (от 5 рабочих дней);
- Экспресс доставка в любую точку России;
- Помощь Конструкторского Отдела и консультации квалифицированных инженеров;
- Техническая поддержка проекта, помощь в подборе аналогов, поставка прототипов;
- Поставка электронных компонентов под контролем ВП;
- Система менеджмента качества сертифицирована по Международному стандарту ISO 9001;
- При необходимости вся продукция военного и аэрокосмического назначения проходит испытания и сертификацию в лаборатории (по согласованию с заказчиком);
- Поставка специализированных компонентов военного и аэрокосмического уровня качества (Xilinx, Altera, Analog Devices, Intersil, Interpoint, Microsemi, Actel, Aeroflex, Peregrine, VPT, Syfer, Eurofarad, Texas Instruments, MS Kennedy, Miteq, Cobham, E2V, MA-COM, Hittite, Mini-Circuits, General Dynamics и др.);

Компания «Океан Электроники» является официальным дистрибьютором и эксклюзивным представителем в России одного из крупнейших производителей разъемов военного и аэрокосмического назначения «JONHON», а так же официальным дистрибьютором и эксклюзивным представителем в России производителя высокотехнологичных и надежных решений для передачи СВЧ сигналов «FORSTAR».



JONHON

«JONHON» (основан в 1970 г.)

Разъемы специального, военного и аэрокосмического назначения:

(Применяются в военной, авиационной, аэрокосмической, морской, железнодорожной, горно- и нефтедобывающей отраслях промышленности)

«FORSTAR» (основан в 1998 г.)

ВЧ соединители, коаксиальные кабели,
кабельные сборки и микроволновые компоненты:

(Применяются в телекоммуникациях гражданского и специального назначения, в средствах связи, РЛС, а так же военной, авиационной и аэрокосмической отраслях промышленности).



Телефон: 8 (812) 309-75-97 (многоканальный)

Факс: 8 (812) 320-03-32

Электронная почта: ocean@oceanchips.ru

Web: <http://oceanchips.ru/>

Адрес: 198099, г. Санкт-Петербург, ул. Калинина, д. 2, корп. 4, лит. А