

# Cree® XLamp® XR-E LED



## PRODUCT DESCRIPTION

The XLamp XR-E LED is leading the LED lighting revolution with its unprecedented lighting-class brightness, efficacy, lifetime and quality of light. These lighting-class features enable the XLamp XR-E LED to replace many traditional light sources and save money with energy-efficient light and long lifetimes.

Cree XLamp LEDs bring high performance and quality of light to a wide range of lighting applications, including color-changing lighting, portable and personal lighting, outdoor lighting, indoor directional lighting, commercial lighting and emergency-vehicle lighting.

## FEATURES

- Available in white (2600 K to 10,000 K CCT), blue, royal blue and green
- Maximum drive current: up to 1000 mA
- Maximum junction temperature: 150 °C
- Industry-leading JEDEC standard pre-qualification testing
- Reflow solderable – JEDEC J-STD-020C compatible
- Electrically neutral thermal path
- RoHS- and REACH-compliant
- UL-recognized component (E326295)



## TABLE OF CONTENTS

Flux Characteristics - White .....	2
Flux Characteristics - Color .....	3
Characteristics .....	4
Relative Spectral Power Distribution .	5
Relative Flux vs. Junction Temperature .....	6
Electrical Characteristics.....	7
Thermal design .....	7
Relative Flux vs. Current .....	8
Typical Spatial Distribution.....	8
Reflow Soldering Characteristics .....	9
Notes.....	10
Mechanical Dimensions.....	12
Tape and reel .....	13
Dry Packaging and Packaging .....	14

## FLUX CHARACTERISTICS (T<sub>j</sub> = 25 °C) - WHITE

The following tables describe the available colors and flux for XR-E LEDs by listing the correlated color temperature or dominant wavelength range for the entire family and by providing several base order codes. It is important to note that the base order codes listed here are a subset of the total available order codes for the product family. For more order codes, as well as a complete description of the order-code nomenclature, please consult the XR Family Binning and Labeling document.

Color	CCT Range		Base Order Codes Min. Luminous Flux		Order Code
	Min.	Max.	Group	Flux (lm)	
Cool White	5000 K	10,000 K	P4	80.6	XREWHT-L1-0000-00901
			Q2	87.4	XREWHT-L1-0000-00A01
			Q3	93.9	XREWHT-L1-0000-00B01
			Q4	100	XREWHT-L1-0000-00C01
			Q5	107	XREWHT-L1-0000-00D01
			R2	114	XREWHT-L1-0000-00E01
Neutral White	3700 K	5000 K	P3	73.9	XREWHT-L1-0000-008E4
			P4	80.6	XREWHT-L1-0000-009E4
			Q2	87.4	XREWHT-L1-0000-00AE4
			Q3	93.9	XREWHT-L1-0000-00BE4
			Q4	100	XREWHT-L1-0000-00CE4
Warm White	2600 K	3700 K	N3	56.8	XREWHT-L1-0000-005E7
			N4	62.0	XREWHT-L1-0000-006E7
			P2	67.2	XREWHT-L1-0000-007E7
			P3	73.9	XREWHT-L1-0000-008E7
			P4	80.6	XREWHT-L1-0000-009E7

### Notes:

- Cree maintains a tolerance of +/- 7% on flux and power measurements, ±0.005 on chromaticity (CC<sub>x</sub>, CC<sub>y</sub>) measurements and ±2 on CRI measurements.
- Typical CRI for Cool White & Neutral White (3700 K – 10,000 K CCT) is 75.
- Typical CRI for Warm White (2600 K – 3700 K CCT) is 80.

## FLUX CHARACTERISTICS (T<sub>j</sub> = 25 °C) - COLOR

The following tables describe the available colors and flux for XR-E LEDs by listing the correlated color temperature or dominant wavelength range for the entire family and by providing several base order codes. It is important to note that the base order codes listed here are a subset of the total available order codes for the product family. For more order codes, as well as a complete description of the order-code nomenclature, please consult the XR Family Binning and Labeling document.

Color	Dominant Wavelength Range				Base Order Codes Min Radiant Flux (mW)		Order Code
	Min.		Max.		Group	Flux (mW)	
	Group	DWL (nm)	Group	DWL (nm)			
Royal Blue	D3	450	D5	465	13	300	XREROY-L1-0000-00801
					14	350	XREROY-L1-0000-00901
					15	425	XREROY-L1-0000-00A01

Color	Dominant Wavelength Range				Base Order Codes Min Luminous Flux (lm)		Order Code
	Min.		Max.		Group	Flux (lm)	
	Group	DWL (nm)	Group	DWL (nm)			
Blue	B3	465	B6	485	J	23.5	XREBLU-L1-0000-00J01
					K	30.6	XREBLU-L1-0000-00K01

Color	Dominant Wavelength Range				Base Order Codes Min. Luminous Flux (lm)		Order Code
	Min.		Max.		Group	Flux (lm)	
	Group	DWL (nm)	Group	DWL (nm)			
Green	G2	520	G4	535	P	67.2	XREGRN-L1-0000-00P01

Note: Cree maintains a tolerance of +/- 7% on flux and power measurements.

**CHARACTERISTICS**

Characteristics	Unit	Minimum	Typical	Maximum
Thermal Resistance, junction to solder point	°C/W		8	
Viewing Angle (FWHM) - white	degrees		90	
Viewing Angle (FWHM) - royal blue, blue, green	degrees		100	
Temperature Coefficient of Voltage - white, royal blue, blue, green	mV/°C		-4.0	
ESD Classification (HBM per Mil-Std-883D)			Class 2	
DC Forward Current - white ≥ 5000 K, royal blue, blue	mA			1000
DC Forward Current - white < 5000 K, green	mA			700
DC Pulse Current (@ 1 kHz, 10% duty cycle)	A			1.8
Reverse Voltage	V			5
Forward Voltage (@ 350 mA)	V		3.3	3.9
Forward Voltage (@ 700 mA)	V		3.5	
Forward Voltage (@ 1000 mA) - white ≥ 5000 K, royal blue, blue	V		3.7	
LED Junction Temperature*	°C			150

**RELATIVE SPECTRAL POWER DISTRIBUTION**

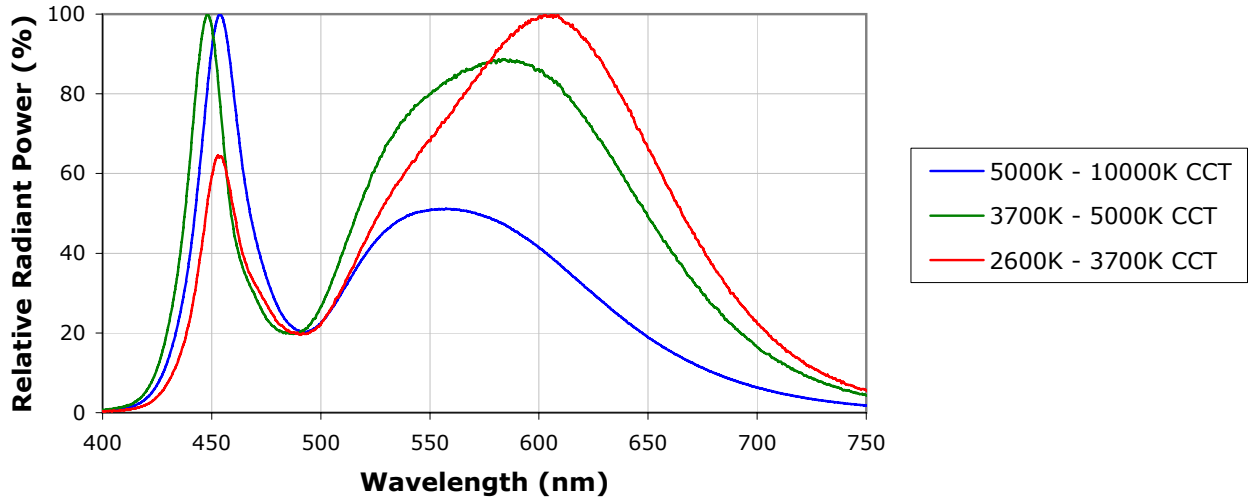

**RELATIVE FLUX VS. JUNCTION TEMPERATURE ( $I_F = 350 \text{ MA}$ )**

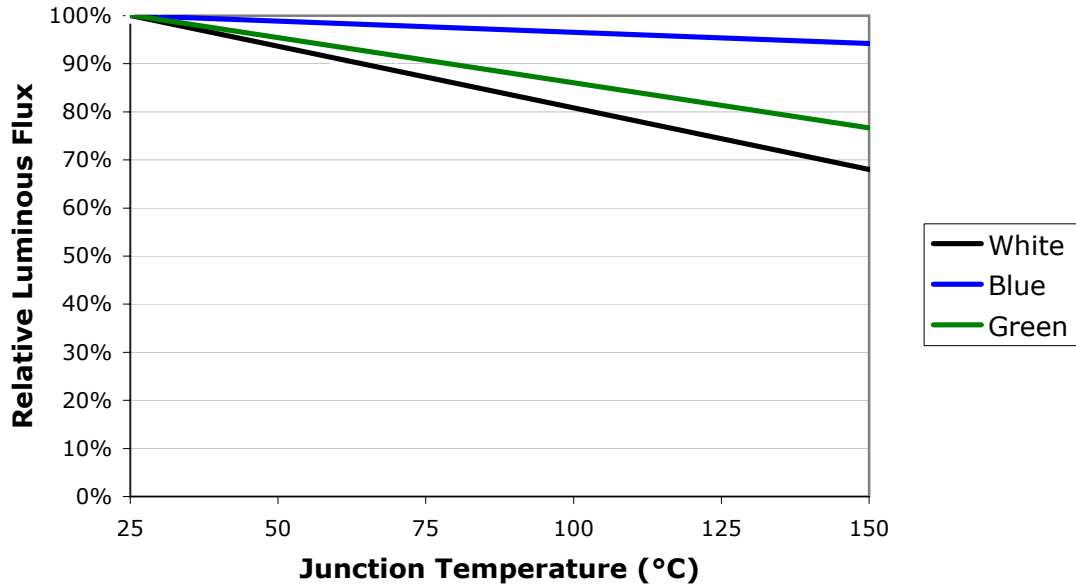

**ELECTRICAL CHARACTERISTICS ( $T_j = 25^\circ\text{C}$ )**



**THERMAL DESIGN**

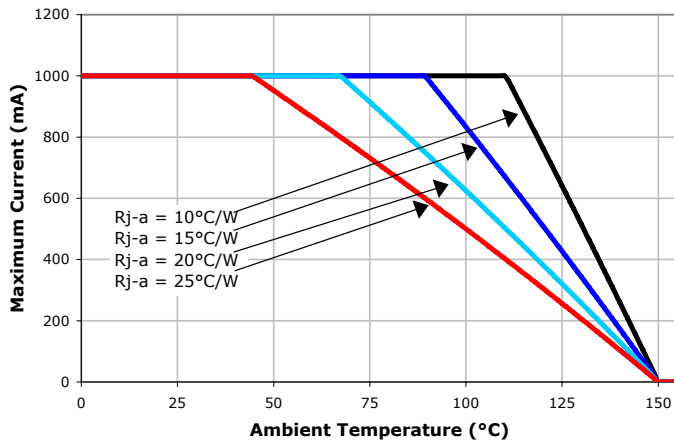

White  $\geq 5,000$  K, Royal Blue, Blue

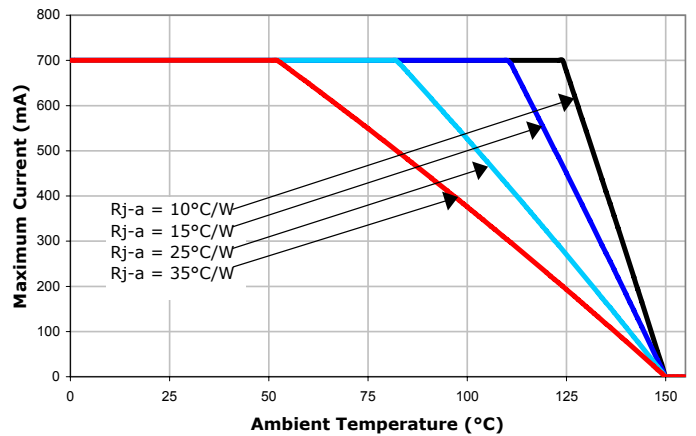

White  $< 5,000$  K, Green

**RELATIVE FLUX VS. CURRENT ( $T_j = 25^\circ\text{C}$ )**



**TYPICAL SPATIAL DISTRIBUTION**





## REFLOW SOLDERING CHARACTERISTICS

In testing, Cree has found XLamp XR-E LEDs to be compatible with JEDEC J-STD-020C, using the parameters listed below. As a general guideline, Cree recommends that users follow the recommended soldering profile provided by the manufacturer of solder paste used.

Note that this general guideline may not apply to all PCB designs and configurations of reflow soldering equipment.



Profile Feature	Lead-Based Solder	Lead-Free Solder
Average Ramp-Up Rate ( $T_{S_{max}}$ to $T_p$ )	3 °C/second max.	3 °C/second max.
Preheat: Temperature Min ( $T_{S_{min}}$ )	100 °C	150 °C
Preheat: Temperature Max ( $T_{S_{max}}$ )	150 °C	200 °C
Preheat: Time ( $t_{S_{min}}$ to $t_{S_{max}}$ )	60-120 seconds	60-180 seconds
Time Maintained Above: Temperature ( $T_L$ )	183 °C	217 °C
Time Maintained Above: Time ( $t_L$ )	60-150 seconds	60-150 seconds
Peak/Classification Temperature ( $T_p$ )	215 °C	260 °C
Time Within 5 °C of Actual Peak Temperature ( $t_p$ )	10-30 seconds	20-40 seconds
Ramp-Down Rate	6 °C/second max.	6 °C/second max.
Time 25 °C to Peak Temperature	6 minutes max.	8 minutes max.

Note: All temperatures refer to topside of the package, measured on the package body surface.

## NOTES

### Lumen Maintenance Projections

Cree now uses standardized IES LM-80-08 and TM-21-11 methods for collecting long-term data and extrapolating LED lumen maintenance. For information on the specific LM-80 data sets available for this LED, refer to the public LM-80 results document at [www.cree.com/xlamp\\_app\\_notes/LM80\\_results](http://www.cree.com/xlamp_app_notes/LM80_results).

Please read the XLamp Long-Term Lumen Maintenance application note at [www.cree.com/xlamp\\_app\\_notes/lumen\\_maintenance](http://www.cree.com/xlamp_app_notes/lumen_maintenance) for more details on Cree’s lumen maintenance testing and forecasting. Please read the XLamp Thermal Management application note at [www.cree.com/xlamp\\_app\\_notes/thermal\\_management](http://www.cree.com/xlamp_app_notes/thermal_management) for details on how thermal design, ambient temperature, and drive current affect the LED junction temperature.

### Moisture Sensitivity

XLamp LEDs are shipped in sealed, moisture-barrier bags (MBB) designed for long shelf life. If XLamp LEDs are exposed to moist environments after opening the MBB packaging but before soldering, damage to the LED may occur during the soldering operation. The following derating table defines the maximum exposure time (in days) for an XLamp LED in the listed humidity and temperature conditions. LEDs with exposure time longer than the time specified below must be baked according to the baking conditions listed below.

Cree recommends keeping XLamp LEDs in their sealed moisture-barrier packaging until immediately prior to use. Cree also recommends returning any unused LEDs to the resealable moisture-barrier bag and closing the bag immediately after use.

Temp.	Maximum Percent Relative Humidity						
	30%	40%	50%	60%	70%	80%	90%
30 °C	9	5	4	3	1	1	1
25 °C	12	7	5	4	2	1	1
20 °C	17	9	7	6	2	2	1

### Baking Conditions

It is not necessary to bake all XLamp LEDs. Only the LEDs that meet all of the following criteria must be baked:

1. LEDs that have been removed from the original MBB packaging.
2. LEDs that have been exposed to a humid environment longer than listed in the Moisture Sensitivity section above.
3. LEDs that have not been soldered.

LEDs should be baked at 80 °C for 24 hours. LEDs may be baked on the original reels. Remove LEDs from MBB packaging before baking. Do not bake parts at temperatures higher than 80 °C. This baking operation resets the exposure time as defined in the Moisture Sensitivity section above.

### **Storage Conditions**

XLamp LEDs that have been removed from original MBB packaging but not soldered yet should be stored in a room or cabinet that will maintain an atmosphere of  $25 \pm 5$  °C and no greater than 10% RH (relative humidity). For LEDs stored in these conditions, storage time does not add to exposure time as defined in the Moisture Sensitivity section above.

### **RoHS Compliance**

The levels of RoHS restricted materials in this product are below the maximum concentration values (also referred to as the threshold limits) permitted for such substances, or are used in an exempted application, in accordance with EU Directive 2011/65/EC (RoHS2), as amended through June 8, 2011. RoHS Declarations for this product can be obtained from your Cree representative or obtained from the Product Ecology section of [www.cree.com](http://www.cree.com).

### **REACH Compliance**

REACH substances of high concern (SVHCs) information is available for this product. Since the European Chemical Agency (ECHA) has published notices of their intent to frequently revise the SVHC listing for the foreseeable future, please contact a Cree representative to insure you get the most up-to-date REACH Declaration. Historical REACH banned substance information (substances restricted or banned in the EU prior to 2010) is also available upon request.

### **Vision Advisory Claim**

**WARNING:** Do not look at exposed lamp in operation. Eye injury can result. See LED Eye Safety at [www.cree.com/xlamp\\_app\\_notes/led\\_eye\\_safety](http://www.cree.com/xlamp_app_notes/led_eye_safety).

**MECHANICAL DIMENSIONS ( $T_A = 25\text{ }^\circ\text{C}$ )**

All measurements are  $\pm .1\text{mm}$  unless otherwise indicated.

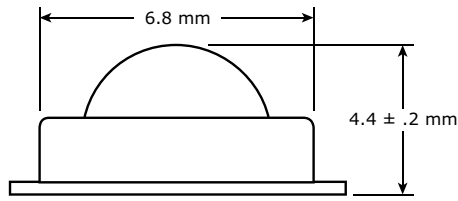
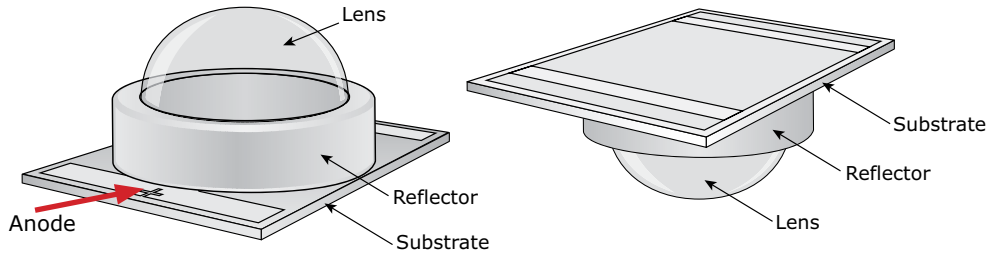

Side View

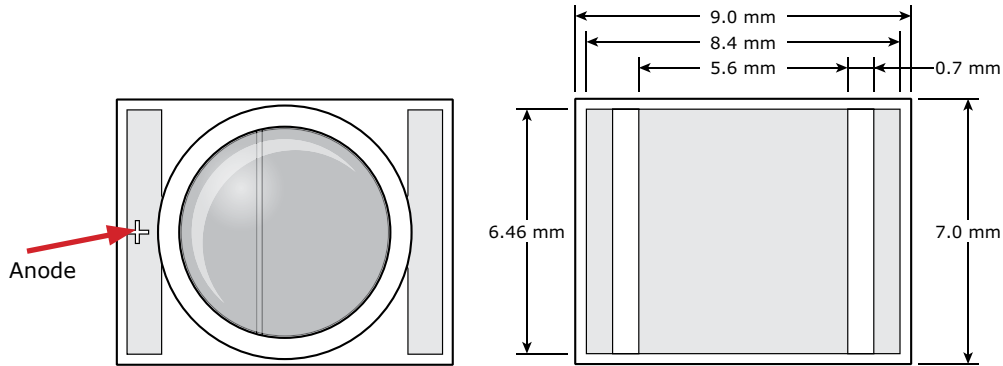

Top View

Bottom View

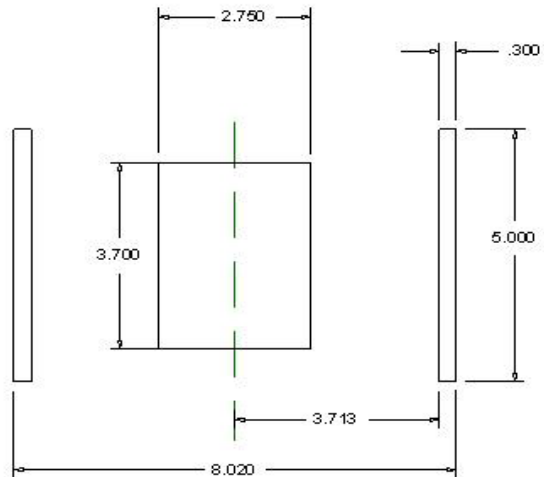

Recommended PC Board Solder Pad

### TAPE AND REEL

All Cree carrier tapes conform to EIA-481D, Automated Component Handling Systems Standard.

All dimensions in mm.

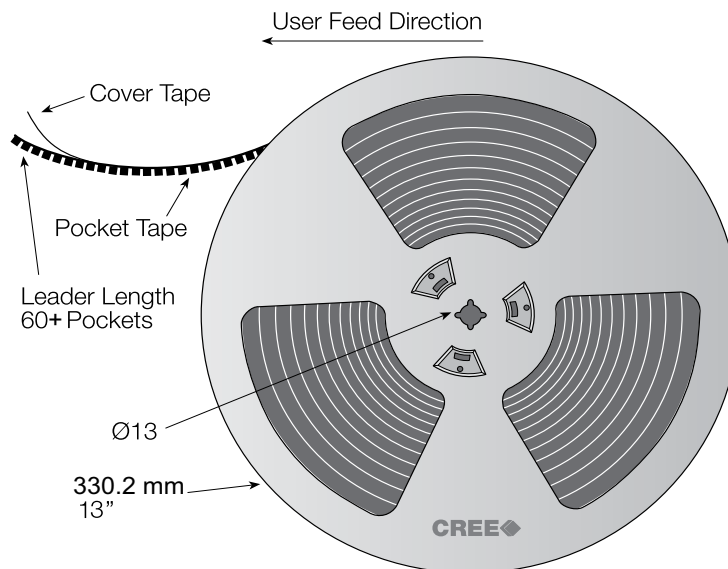

**DRY PACKAGING AND PACKAGING**

**Unpackaged Reel**



Label with Cree Bin Code, Qty, Reel ID

**Packaged Reel**



Desiccant (inside bag)

Humidity Indicator Card (inside bag)

Label with Cree Order Code, Qty, Reel ID, PO #

Label with Cree Bin Code, Qty, Reel ID

**Boxed Reel**



Label with Cree Order Code, Qty, Reel ID, PO #

Label with Cree Bin Code, Qty, Reel ID

Patent Label

Компания «Океан Электроники» предлагает заключение долгосрочных отношений при поставках импортных электронных компонентов на взаимовыгодных условиях!

Наши преимущества:

- Поставка оригинальных импортных электронных компонентов напрямую с производств Америки, Европы и Азии, а так же с крупнейших складов мира;
- Широкая линейка поставок активных и пассивных импортных электронных компонентов (более 30 млн. наименований);
- Поставка сложных, дефицитных, либо снятых с производства позиций;
- Оперативные сроки поставки под заказ (от 5 рабочих дней);
- Экспресс доставка в любую точку России;
- Помощь Конструкторского Отдела и консультации квалифицированных инженеров;
- Техническая поддержка проекта, помощь в подборе аналогов, поставка прототипов;
- Поставка электронных компонентов под контролем ВП;
- Система менеджмента качества сертифицирована по Международному стандарту ISO 9001;
- При необходимости вся продукция военного и аэрокосмического назначения проходит испытания и сертификацию в лаборатории (по согласованию с заказчиком);
- Поставка специализированных компонентов военного и аэрокосмического уровня качества (Xilinx, Altera, Analog Devices, Intersil, Interpoint, Microsemi, Actel, Aeroflex, Peregrine, VPT, Syfer, Eurofarad, Texas Instruments, MS Kennedy, Miteq, Cobham, E2V, MA-COM, Hittite, Mini-Circuits, General Dynamics и др.);

Компания «Океан Электроники» является официальным дистрибьютором и эксклюзивным представителем в России одного из крупнейших производителей разъемов военного и аэрокосмического назначения «JONHON», а так же официальным дистрибьютором и эксклюзивным представителем в России производителя высокотехнологичных и надежных решений для передачи СВЧ сигналов «FORSTAR».



## JONHON

«JONHON» (основан в 1970 г.)

Разъемы специального, военного и аэрокосмического назначения:

(Применяются в военной, авиационной, аэрокосмической, морской, железнодорожной, горно- и нефтедобывающей отраслях промышленности)

«FORSTAR» (основан в 1998 г.)

ВЧ соединители, коаксиальные кабели, кабельные сборки и микроволновые компоненты:

(Применяются в телекоммуникациях гражданского и специального назначения, в средствах связи, РЛС, а так же военной, авиационной и аэрокосмической отраслях промышленности).



Телефон: 8 (812) 309-75-97 (многоканальный)

Факс: 8 (812) 320-03-32

Электронная почта: [ocean@oceanchips.ru](mailto:ocean@oceanchips.ru)

Web: <http://oceanchips.ru/>

Адрес: 198099, г. Санкт-Петербург, ул. Калинина, д. 2, корп. 4, лит. А