

AUXILIARY ACTUATORS

Easy to assemble auxiliary actuators for the MM Series provides the end-user with the capability to operate the switch with force not directly in line with the operating button. Actuators are available in either the plain-leaf or roller-leaf style. Each actuator kit consists of the stainless steel spring-leaf with an integral side mounting plate, flexible insulator, two (2) #2-56 x 7/16" roundhead screws, with lockwashers and hex nuts. Actuator and hardware are supplied unassembled. Specially formed auxiliary actuators are available, consult Customer Service Center.

ALS-1 LEAF



SWITCH CHARACTERISTICS

OPERATING FORCE (MAX)	$\frac{\text{oz}}{\text{grams}}$	$\frac{6}{170}$
RELEASE FORCE (MIN)	$\frac{\text{oz}}{\text{grams}}$	$\frac{2}{56}$
DIFFERENTIAL TRAVEL (MAX)	$\frac{\text{in}}{\text{mm}}$	$\frac{.025}{(0,64)}$
PRETRAVEL (MAX)	$\frac{\text{in}}{\text{mm}}$	$\frac{.110}{(2,79)}$
OVERTRAVEL (MIN)	$\frac{\text{in}}{\text{mm}}$	$\frac{.015}{(0,38)}$

ALS-2 LEAF (Low Motion)



SWITCH CHARACTERISTICS

OPERATING FORCE (MAX)	$\frac{\text{oz}}{\text{grams}}$	$\frac{7}{198}$
RELEASE FORCE (MIN)	$\frac{\text{oz}}{\text{grams}}$	$\frac{2}{56}$
DIFFERENTIAL TRAVEL (MAX)	$\frac{\text{in}}{\text{mm}}$	$\frac{.025}{(0,64)}$
PRETRAVEL (MAX)	$\frac{\text{in}}{\text{mm}}$	$\frac{.225}{(5,72)}$
OVERTRAVEL (MIN)	$\frac{\text{in}}{\text{mm}}$	$\frac{.015}{(0,38)}$

AWS-1 LEAF ROLLER

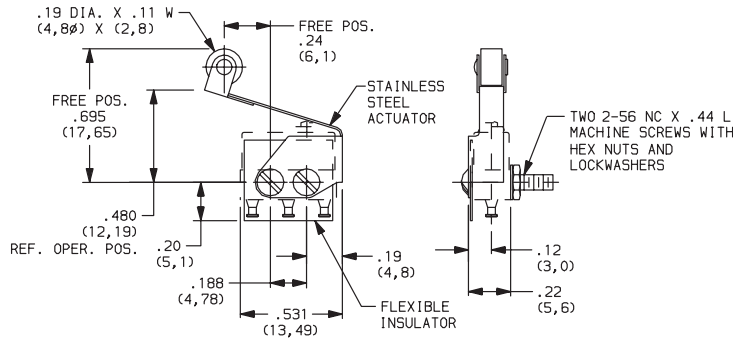

SWITCH CHARACTERISTICS

OPERATING FORCE (MAX)	$\frac{\text{oz}}{\text{grams}}$	$\frac{6}{170}$
RELEASE FORCE (MIN)	$\frac{\text{oz}}{\text{grams}}$	$\frac{2}{56}$
DIFFERENTIAL TRAVEL (MAX)	$\frac{\text{in}}{\text{mm}}$	$\frac{.025}{(0,64)}$
PRETRAVEL (MAX)	$\frac{\text{in}}{\text{mm}}$	$\frac{.110}{(2,79)}$
OVERTRAVEL (MIN)	$\frac{\text{in}}{\text{mm}}$	$\frac{.015}{(0,38)}$

AWS-2 LEAF ROLLER (Low Motion)

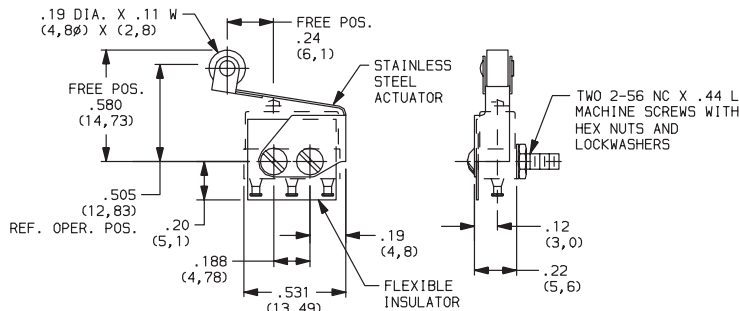

SWITCH CHARACTERISTICS

OPERATING FORCE (MAX)	$\frac{\text{oz}}{\text{grams}}$	$\frac{7}{198}$
RELEASE FORCE (MIN)	$\frac{\text{oz}}{\text{grams}}$	$\frac{2}{56}$
DIFFERENTIAL TRAVEL (MAX)	$\frac{\text{in}}{\text{mm}}$	$\frac{.025}{(0,64)}$
PRETRAVEL (MAX)	$\frac{\text{in}}{\text{mm}}$	$\frac{.225}{(5,72)}$
OVERTRAVEL (MIN)	$\frac{\text{in}}{\text{mm}}$	$\frac{.015}{(0,38)}$

AUXILIARY ACTUATORS

Basic precision HB Series switches, with any terminal style, can be used with these attachable actuators. As supplied, the actuator is not assembled to the switch; the switch must be ordered separately. The actuator can be assembled to the switch before mounting, or the actuator can be mounted on the panel or chassis and the switch installed after wiring. Assembly screws, nuts and lockwashers are furnished.

BB-1 SEALED PLUNGER (For use with P0 actuator option.)

BB-2 SEALED PLUNGER (For use with PS sealed actuator option.)



Actuator assembly sealed to mounting surface by flexible boot and o-ring seal.

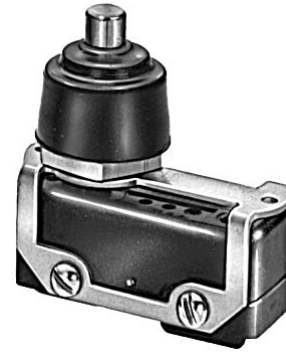

BJ-1 OVERTRAVEL PLUNGER (For use with P0 actuator option.)

BJ-2 OVERTRAVEL PLUNGER (For use with PS sealed actuator option.)

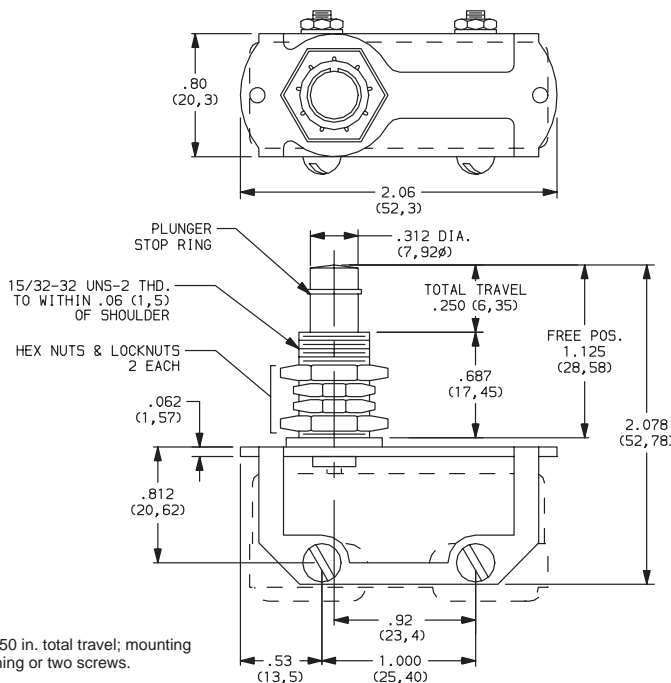

Provides up to .250 in. total travel; mounting by threaded bushing or two screws.

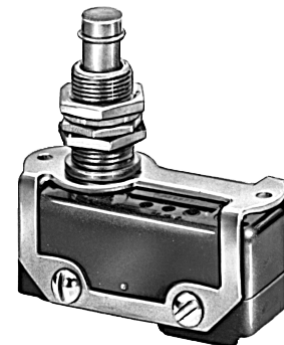

CAPS

EP & TP SERIES, .100" DIA. PLUNGERS



PART NO.

- 508101000** WHITE
- 508102000** BLACK
- 508103000** RED

TP SERIES, .100" DIA. PLUNGERS (Recommended for S9 plunger)



PART NO.

- 538701000** WHITE
- 538702000** BLACK
- 538703000** RED

EP & TP SERIES, .100" DIA. PLUNGERS



PART NO.

- 465801000** WHITE
- 465802000** BLACK
- 465803000** RED

8600 & KM33 SERIES, .106" DIA. PLUNGERS



PART NO.

- 785101000** WHITE
- 785102000** BLACK
- 785103000** RED

8020, 8060, E010, E020, KM11, L & TP SERIES, .122" DIA. PLUNGERS



PART NO.

- 708901000** WHITE
- 708902000** BLACK
- 708903000** RED

8020, 8060, E010, E020, KM11 & L SERIES, .122" DIA. PLUNGERS



PART NO.

- 752701000** WHITE
- 752702000** BLACK
- 752703000** RED

8020, 8060, E010, E020, KM11, L & TP SERIES .122" DIA. PLUNGERS



PART NO.

- 801801000** WHITE
- 801802000** BLACK
- 801803000** RED

.157" DIA. PLUNGERS



PART NO.

- 267A01000** WHITE
- 267A02000** BLACK
- 267A03000** RED

FOR SERIES
85X2T, 8534T
Models only

PART NO.

- 893101000** WHITE
- 893102000** BLACK
- 893103000** RED

FOR SERIES
85X1T, 8532T1,
8533T, 8534T1 Models only

8020, 8050, E010, E020 & L SERIES, .122" DIA. SNAP-FITTING PLUNGERS

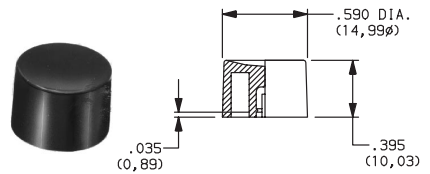

PART NO.

- 894001000** WHITE
- 894002000** BLACK
- 894003000** RED

EP11 & EP12 MODELS, .100 DIA. SNAP-FITTING PLUNGERS



PART NO.

- 585A01000** WHITE
- 585A02000** BLACK
- 585A03000** RED

EP11 & EP12 MODELS, .100 DIA. SNAP-FITTING PLUNGERS



PART NO.

- 785A01000** WHITE
- 785A02000** BLACK
- 785A03000** RED

8020, 8050, E010, E020 & L SERIES, .122" DIA. SNAP-FITTING PLUNGERS



PART NO.

- 894101000** WHITE
- 894102000** BLACK
- 894103000** RED

MATERIAL

Nylon. Finish: Gloss.

Special colors, custom markings available, consult Customer Service Center.

CAPS

KA SERIES, K1 CRUCIFORM ACTUATORS



PART NO.

699101000 WHITE
699102000 BLACK
699103000 RED

MATERIAL

Nylon; Finish: Matte

MP SERIES



PART NO.

489401000 WHITE
489402000 BLACK
489403000 RED

MATERIAL

Polycarbonate-ABS blend; Finish: Matte

MP SERIES WITH TWO LED

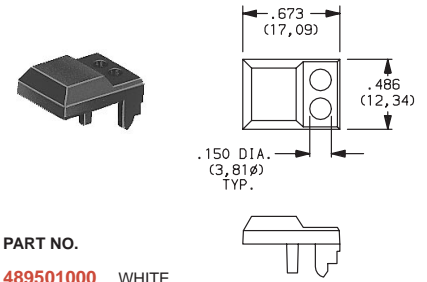

PART NO.

489501000 WHITE
489502000 BLACK
489503000 RED

MATERIAL

Polycarbonate-ABS blend; Finish: Matte

MP SERIES WITHOUT LED



PART NO.

489601000 WHITE
489602000 BLACK
489603000 RED

MATERIAL

Polycarbonate-ABS blend; Finish: Matte

MP SERIES WITH LED



PART NO.

489701000 WHITE
489702000 BLACK
489703000 RED

MATERIAL

Polycarbonate-ABS blend; Finish: Matte

MP SERIES WITH TWO LED

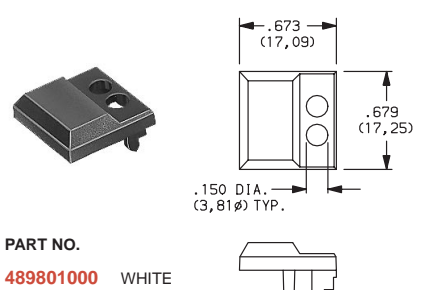

PART NO.

489801000 WHITE
489802000 BLACK
489803000 RED

MATERIAL

Polycarbonate-ABS blend; Finish: Matte

MP SERIES, ANTI-STATIC WITH TRANSPARENT LENS

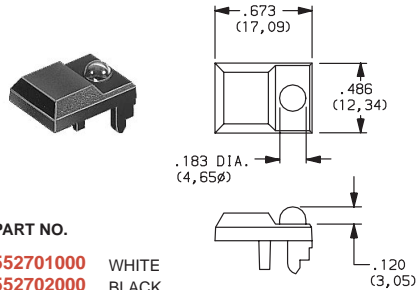

PART NO.

552701000 WHITE
552702000 BLACK
552703000 RED

MATERIAL

Polycarbonate-ABS blend; Finish: Matte

MP SERIES

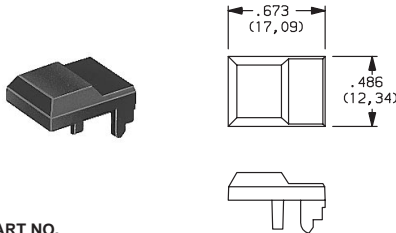

PART NO.

489301000 WHITE
489302000 BLACK
489303000 RED

MATERIAL

Polycarbonate-ABS blend; Finish: Matte

S SERIES, 03 ACTUATOR

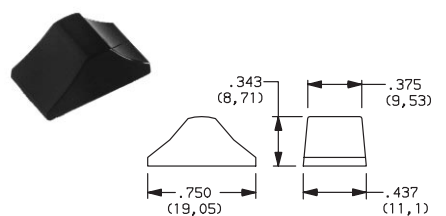

PART NO.

121000101 WHITE
121000102 BLACK
121000103 RED

MATERIAL

6/6 Nylon; Finish: Gloss

S SERIES, C1-C9 ACTUATORS

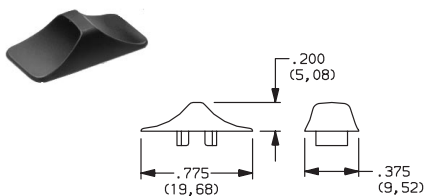

PART NO.

121160100 WHITE
121160200 BLACK
121160300 RED

MATERIAL

6/6 NYLON; Finish: Matte

L SERIES

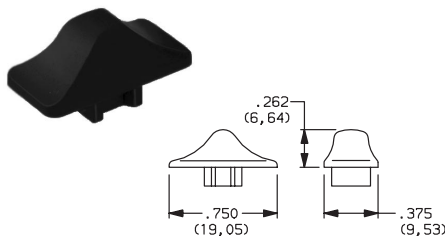

PART NO.

120100602 BLACK

MATERIAL

6/6 Nylon; Finish: Matte

.122" DIA. PLUNGERS

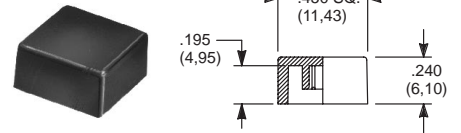

GLOSS

PART NO.

484601000 WHITE
484602000 BLACK
484603000 RED

FOR SERIES

8020, 8060, E010, E020, KM11, L, TP.

MATTE

PART NO.

798201000 WHITE
798202263 BLACK
798203000 RED

FOR SERIES

8020, 8060, E010, E020, KM11, L, TP.

Special colors, custom markings available, consult Customer Service Center.

CAPS

7000, 9000 & E SERIES TOGGLE CAPS



PART NO.

- 896801000 WHITE
- 896802000 BLACK
- 896803000 RED

Material: Polyethylene

7000 SERIES TOGGLE CAPS



PART NO.

- 763701000 WHITE
- 763702000 BLACK
- 763703000 RED

Material: Vinyl

7000, 9000, E & ET SERIES TOGGLE CAPS



PART NO.

- 706201000 WHITE
- 706202000 BLACK
- 706203000 RED

Material: Vinyl

8500 SERIES, .157" DIA. PLUNGERS

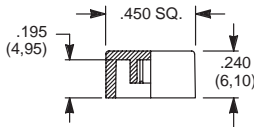

PART NO.

- 448901000 WHITE
- 448902000 BLACK
- 448903000 RED

8020 & 8060 SERIES, .122" DIA. PLUNGERS

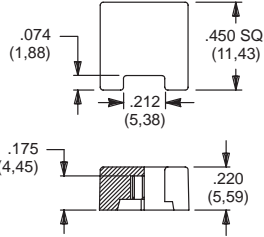
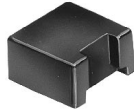

MATTE

GLOSS

PART NO.

- | | | |
|-----------|-----------|-------|
| 459701000 | 476801000 | WHITE |
| 459702000 | 476802000 | BLACK |
| 459703000 | 476803000 | RED |

PN SERIES, .110" SQ. PLUNGERS

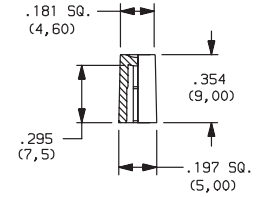

PART NO.

- 979A01000 WHITE
- 979A02000 BLACK
- 979A03000 RED

MATERIAL
ABS

PN SERIES, .130" SQ. PLUNGERS

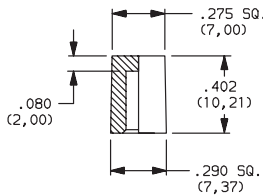

PART NO.

- 980A01000 WHITE
- 980A02000 BLACK
- 980A03000 RED

MATERIAL
ABS

PN SERIES, .110" SQ. PLUNGERS

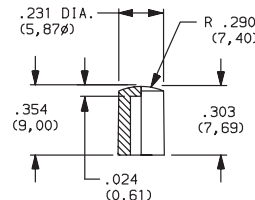

PART NO.

- 981A01000 WHITE
- 981A02000 BLACK
- 981A03000 RED

MATERIAL
ABS

PN SERIES, .130" SQ. PLUNGERS

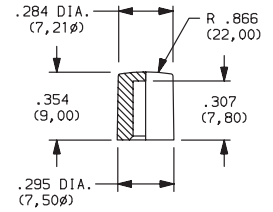

PART NO.

- 982A01000 WHITE
- 982A02000 BLACK
- 982A03000 RED

MATERIAL
ABS

PN SERIES, .130" SQ. PLUNGERS

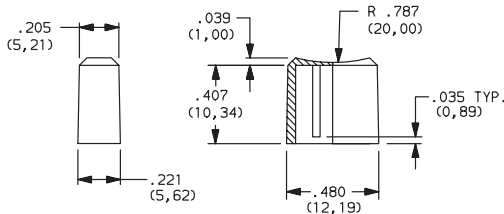

PART NO.

- 983A01000 WHITE
- 983A02000 BLACK
- 983A03000 RED

MATERIAL
ABS

MATERIAL

Nylon. Finish: Matte or gloss.

Special colors, custom markings available, consult Customer Service Center.

CODED SWITCHES – BLANK (INACTIVE) SECTIONS

3U SERIES BLANK SECTION, .302" THK.
(Replaces active section.)



PART NO.
123B002000 BLACK
123B009000 GRAY

3P SERIES BLANK SECTION, .300" THK.



PART NO.
663702000 BLACK
663709000 GRAY

S2 SERIES BLANK SECTION, .315" THK.

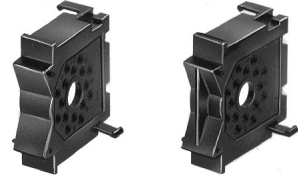

2127 2290

PART NO.
212702000 PLAIN-BLACK
229002000 W/RIB-BLACK

3 SERIES FRONT MOUNT, TYPE 0 & 3,
.315" THK.

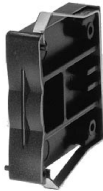

PART NO.
413602000 W/RIB-BLACK
413609000 W/RIB-GRAY
400502000 W/RIB & W/OUT SPRINGS-BLACK
400509000 W/RIB & W/OUT SPRINGS GRAY

3 SERIES FRONT MOUNT, TYPE 0 & 3,
.315" THK.

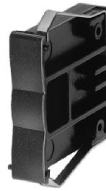

PART NO.
413502000 PLAIN-BLACK
413509000 PLAIN-GRAY
400702000 PLAIN W/OUT SPRINGS-BLACK
400709000 PLAIN W/OUT SPRINGS GRAY

3 SERIES REAR MOUNT, TYPE 1,
.350" THK.

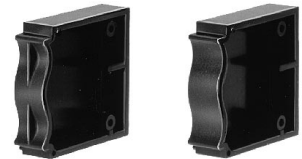

4006 4008

PART NO.
400602000 W/RIB-BLACK
400609000 W/RIB-GRAY
400802000 PLAIN-BLACK
400809000 PLAIN-GRAY

3 SERIES REAR MOUNT, TYPE 2,
.350" THK.

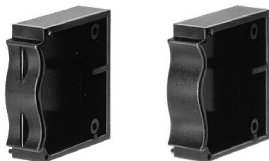

4734 4733

PART NO.
473402000 W/RIB-BLACK
473409000 W/RIB-GRAY
473302000 PLAIN-BLACK
473309000 PLAIN-GRAY



CODED SWITCHES – END PLATES

S2 SERIES REAR MOUNT, MOUNTING STYLE S2S
WITH .157" (4MM) FLANGE



PART NO.

211702000 BLACK
211709000 GRAY

Two required for complete assembly.

S2 SERIES REAR MOUNT, MOUNTING STYLE S2R
WITH .315" (8MM) FLANGE



PART NO.

211802000 BLACK
211809000 GRAY

Two required for complete assembly.

S2 SERIES REAR MOUNT, MOUNTING STYLE S2T
WITH NO FLANGE



PART NO.

212002000 BLACK
212009000 GRAY

Two required for complete assembly.

S2 SERIES FRONT MOUNT, MOUNTING STYLE S2F



PART NO.

211902000 BLACK
211909000 GRAY

Two required for complete assembly.

3U SERIES



LEFT-with hole RIGHT-with pin

PART NO.

113B02000 LEFT-BLACK
113B09000 LEFT-GRAY

114B02000 RIGHT-BLACK
114B09000 RIGHT-GRAY

One left and one right piece required for complete assembly.

3 SERIES FRONT MOUNT, TYPE 3



PART NO.

655702000 BLACK
655709000 GRAY

Two required for complete assembly.

3 SERIES FRONT MOUNT, TYPE 0



PART NO.

413402000 BLACK
413409000 GRAY

Two required for complete assembly.

3 SERIES REAR MOUNT, TYPE 1



PART NO.

400402000 BLACK
400409000 GRAY

Two required for complete assembly.

3 SERIES REAR MOUNT, TYPE 2



PART NO.

473202000 BLACK
473209000 GRAY

Two required for complete assembly.

3P SERIES



LEFT-with hole RIGHT-with pin

PART NO.

623502000 LEFT-BLACK
623509000 LEFT-GRAY
623602000 RIGHT-BLACK
623609000 RIGHT-GRAY

One left and one right piece required for complete assembly.



CODED SWITCHES – SPACERS

3P SERIES, .100" THK.
(Makes section pitch .400")



PART NO.
663602000 BLACK
663609000 GRAY

3 SERIES FRONT MOUNT-FITS TYPE 0 & 3,
.185" THK. (Makes section pitch .500")



PART NO.
410602000 BLACK
410609000 GRAY

3 SERIES FRONT MOUNT, FITS TYPE 0 & 3,
.078" THK. (Makes section pitch 10mm)



PART NO.
410802000 BLACK
410809000 GRAY

3 SERIES REAR MOUNT, FITS TYPE 1,
.150" THK. (Makes section pitch .500")



PART NO.
410702000 BLACK
410709000 GRAY

3 SERIES REAR MOUNT, FITS TYPE 2,
.150" THK. (Makes section pitch .500")



PART NO.
473602000 BLACK
473609000 GRAY

HARDWARE FOR FIELD ASSEMBLY-3 SERIES ONLY.

SCREWS FOR FIELD ASSEMBLY OF THUMBWHEEL SWITCHES
(2 screws needed per assembly + 403500000 nuts)

SCREW PART NUMBER (0-80 UNF THD. SIZE)	NUMBER OF SECTIONS IN ASSEMBLY				
	FRONT MOUNTING			REAR MOUNTING	
	MTG. STYLE – 00, 30	MTG. STYLE – 03, 33	MTG. STYLE – 04, 34	MTG. STYLE – 10, 20	MTG. STYLE – 14, 24
412700000	1 – 2	1	1	1 – 2	1
412701000	3 – 4	2 – 3	2	3	2
412702000	5 – 7	4 – 5	3 – 4	4 – 6	3 – 4
412703000	8 – 10	6 – 8	5 – 6	7 – 9	5 – 6
412704000	11 – 13	9 – 10	7 – 8	10 – 12	7 – 8
412705000	14 – 16	11 – 13	9 – 10	13 – 15	9 – 10

See 3 series mounting styles, pages J-11 thru J-14.

NUT



PART NO.
403500000
Two nuts required per assembly and screws.

NUT DRIVER (For 403500000 nut)



PART NO.
406100652
Not required for assembly.
Not supplied with sample pieces.

FIXING SPANNERS

RAFI 15.2mm, Lumotast 75 & 8.1mm



PART NO.
5.58002.0190000

DESCRIPTION
Tool used to secure switch to panel.
Tightens threaded fixing ring.

RAFIX 16



PART NO.
5.58002.0340000

DESCRIPTION
Tool used to secure switch to panel.
Tightens hexagon nut.

FRAMES

7000 & E SERIES
J11, J21 ACTUATORS



Material: Spring Steel.

PART NO.
764500223 BRIGHT CHROME
764500252 SATIN CHROME
764500746 BLACK ENAMEL
764500747 WHITE ENAMEL
764601106 RETAINING SPRING

7000 & E SERIES
J16, J26 ACTUATORS



Material: Nylon.
Finish: Matte.

PART NO.
459101000 WHITE
459102000 BLACK
459103000 RED

7000, 8020, 8060 & 8500 SERIES
J51, J61, J81, J83, J85, J86, J91 ACTUATORS



Material: Nylon.
Finish: Matte.

PART NO.
615601000 WHITE
615602263 BLACK
615603000 RED

J19 ACTUATOR



Material: Spring Steel.

PART NO.
781000223 BRIGHT CHROME
781000252 SATIN CHROME
781000746 BLACK ENAMEL
781000747 WHITE ENAMEL

7000 & 9000 SERIES
J37, J47, J57 ACTUATORS



Material: Spring Steel.

PART NO.
445400223 BRIGHT CHROME
445400252 SATIN CHROME
445400746 BLACK ENAMEL
445400747 WHITE ENAMEL

7000, 8020, 8060 & 8500 SERIES
J52, J62, J82, J84, J92 ACTUATORS



Material: Nylon.
Finish: Matte.

PART NO.
613301000 WHITE
613302263 BLACK
613303000 RED

J50, J60, J80, J83, J90 ACTUATORS



Material: Nylon.
Finish: Matte or Gloss.

MATTE GLOSS
PART NO. PART NO.
486701000 486801000 WHITE
486702000 486802000 BLACK
486703000 486803000 RED

7000 SERIES
J76 ACTUATORS



Material: Nylon.
Finish: Matte.

PART NO.
724A01000 WHITE
724A02000 BLACK
724A03000 RED

Special colors, custom markings available, consult Customer Service Center.

FRAMES—SEPARATE SNAP-IN

Frames snap into panel opening and are independent from switch mounting. Accurate positioning of the PC mounted switch relative to the panel opening is necessary to provide proper clearance between actuator and frame. Available in two basic styles and four panel thicknesses .047-.125 in. Material: Nylon. Finish: Matte.

TYPICAL APPLICATION

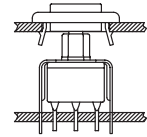

7000 & E SERIES
J1, J2 ACTUATORS

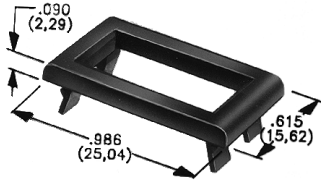

.047" (1,19) PANEL THK. .062" (1,57) PANEL THK. .090" (2,29) PANEL THK. .125" (3,18) PANEL THK.

PART NO.	PART NO.	PART NO.	PART NO.
452901000	452701000	452801000	452601000
452902263	452702263	452802263	452602263
452903000	452703000	452803000	452603000
			WHITE
			BLACK
			RED

7000, 8020, 8060, 8500, E, E010, E020 & TP SERIES
J50, J60, J80, J90 ACTUATORS

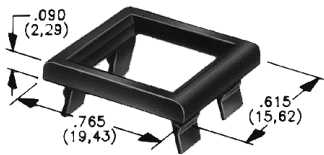

.047" (1,19) PANEL THK. .062" (1,57) PANEL THK. .090" (2,29) PANEL THK. .125" (3,18) PANEL THK.

PART NO.	PART NO.	PART NO.	PART NO.
432501000	432601000	432701000	432801000
432502263	432602263	432702263	432802263
432503000	432603000	432703000	432803000
			WHITE
			BLACK
			RED

4529, 4527, 4528, 4526

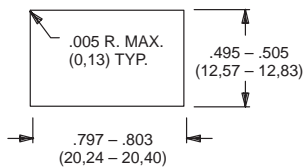

PANEL MOUNTING

4325, 4326

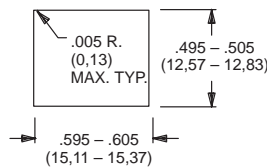

4327, 4328

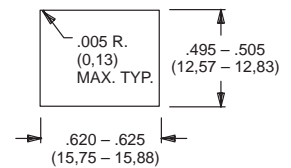

PANEL INSERTS

(WILL FIT SEPARATE SNAP-IN FRAMES FOR J50, J60, J90 ACTUATORS).

Above frames (part nos. 432XXXXXX) are also available with insert which accepts LED for indicator light assembly. Order insert separately from frame. Blank insert panel (without hole for LED) also available. LED not included, see page L-17 for LED information and recommendations.

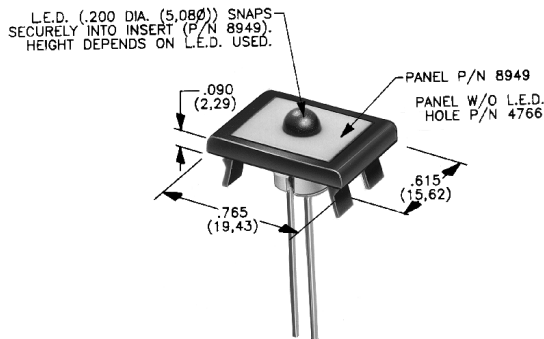

PANEL INSERT WITH HOLE FOR LED

PART NO.
894901000
894902000
894903000

BLANK PANEL INSERT WITHOUT HOLE FOR LED

PART NO.	
476601000	WHITE
476602000	BLACK
476603000	RED

Special colors, custom markings available, consult Customer Service Center.



INSERT

D SERIES



PART NO.
057190200

MATERIAL
Zinc nylon 6/6
Finish: Matte

KEYS



4 TUMBLER
PART NO. (ONE KEY)
115140126

MATERIAL
Brass; Finish: Nickel plate

FOR SERIES
A, H, P, W, Y, YL
Key Code: A126

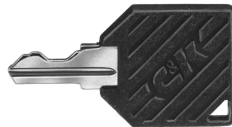

4 TUMBLER
PART NO. (ONE KEY)
11599112601 WHITE
11599112602 BLACK
11599112603 RED
11599112600 BEIGE

MATERIAL
Brass; Finish: Nickel plate;
6/6 Nylon insert molded head

FOR SERIES
A, H, P, W, Y, YL
Key Code: A126

5 TUMBLER
PART NO. (ONE KEY)
11622100101 WHITE
11622100102 BLACK
11622100103 RED
11622100100 BEIGE

MATERIAL
Brass; Finish: Nickel plate;
6/6 Nylon insert molded head

FOR SERIES
A, BY, GY, H, Y, YL
Key Code: D001

A, H, W, Y & YL SERIES
KEY CODE: AAAA



PART NO. (ONE KEY)
1110801

MATERIAL
Zinc alloy;
Finish: Chrome plate

PF, PL & PM SERIES
KEY CODE: 041



PART NO. (ONE KEY)
16916004101 WHITE
16916004102 BLACK
16916004103 RED
16916004100 BEIGE

MATERIAL
Brass; Finish: Nickel plate;
6/6 Nylon insert molded head

YF & YM SERIES
KEY CODE: 0029



PART NO. (ONE KEY)
119091029

MATERIAL
Brass; Finish: Nickel plate

BY, GY SERIES
KEY CODE: 3434



PART NO. (ONE KEY)
11630CKBYST

MATERIAL
Zinc alloy;
Finish: Chrome plate

A, BY, H, P, W, Y & YL SERIES
Key Code: A126



PART NO. (ONE KEY)
16564112601 WHITE
16564112602 BLACK
16564112603 RED
16564112600 BEIGE

MATERIAL
Brass; Finish: Nickel plate;
6/6 Nylon insert molded head

RAFI LUMOTAST 75



PART NO. (ONE KEY)
5.58004.7210000

RAFIX 16



PART NO. (ONE KEY)
5.58007.0010000

LAMP EXTRACTORS



PART NO.

1.90900.0010000

FOR SERIES

RAFI 8.1 mm Illuminated Pushbutton

DESCRIPTION

Tool used to remove lamps or LEDs from switches.

PART NO.

1.90900.0020000

FOR SERIES

RAFI Lumotast® 75

DESCRIPTION

Tool used to remove lamps or LEDs from switches.

PART NO.

1.90900.0030000

FOR SERIES

RAFIX 16

DESCRIPTION

Tool used to remove lamps or LEDs from switches.

LEDS & FILAMENT LAMPS

MP SERIES

02, R2 & S2 CAP STYLES

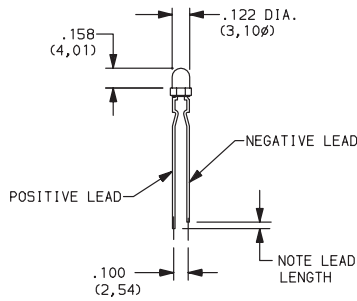

PART NO.

- 498703615 RED
- 498705615 YELLOW
- 498706615 GREEN

MP SERIES

01, A1, A2 & S1 CAP STYLES



PART NO.

- 498703614 RED
- 498705614 YELLOW
- 498706614 GREEN

LED PART NUMBER	DESCRIPTION	COLOR	BASE	VOLTAGE U _B	FORWARD CURRENT I _F	FOR SERIES	LAMP EXTRACTOR PART NUMBER
1.90691.0260000 1.90691.0270000 1.90691.0280000	1 Chip LED	Red Green Yellow	Bi-pin T1	DC*	10 mA	8.1mm Illuminated Pushbutton	1.90900.0010000
1.90692.0010000 1.90692.0020000 1.90692.0030000	1 Chip LED	Red Green Yellow	T4.5	DC*	10 mA	Lumotast® 75	1.90900.0010000
1.90692.0450000 1.90692.0460000 1.90692.0470000	6 chip LED	Red Green Yellow	W 2x4.6 d	24 +10% AC/DC max.	12 mA	RAFIX 16	1.90900.0030000

*Must install a suitable external series resistor.

FILAMENT LAMP	PART NUMBER	DESCRIPTION	BASE	RATED VOLTAGE	RATED CURRENT (A or mA)	RATED POWER (W)	AVERAGE OPERATING LIFE (Hrs.)	FOR SERIES	LAMP EXTRACTOR PART NUMBER
	1.90100.0210000 1.90100.0220000 1.90100.0230000	Miniature Telephone Filament Lamp	T 4.5	6 V 12 V 24 V	0.05 A 0.04 A 0.02 A	0.3 0.48 0.48	10,000 10,000 8,000	Lumotast® 75	1.90900.0020000
	1.90120.0130000 1.90120.0120000 1.90120.0110000 1.90120.0090000	Filament Lamp	W 2x4.6 d	6 V 12 V 24 V 60 V	0.20 A 0.08 A 0.04 A 0.02 A	1.2 1.2 1.2 1.2	20,000 15,000 7,000 3,300	RAFIX 16	1.90900.0030000
	1.90180.4710000 1.90180.4720000 1.90180.4730000	Indicator Lamp T1	Bi-pin	6 V 12/14 V 24/28 V	0.05 A 0.03 A 0.016 A	0.3 0.4-.56 0.4-.56	50,000 20,000 5,000	8.1 mm Illum. Pushbuttons	1.90900.0010000



LOCKING RINGS

T & TP SERIES
FITS 10-48 BUSHING

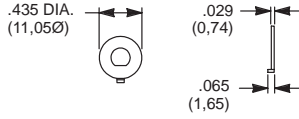

PART NO.
465000201 NICKEL PLATED WITH FLAT

7000, 8020, 8060, 8500, 9000, M, T & TP SERIES
FITS 1/4-40 BUSHING

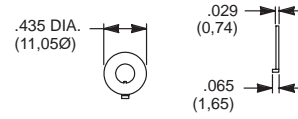

PART NO.
700701201 NICKEL PLATED WITH KEYWAY
700701264 BLACK WITH KEYWAY

T & TP SERIES
FITS 10-48 BUSHING

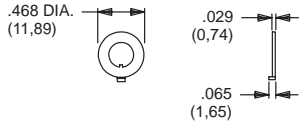

PART NO.
465101201 NICKEL PLATED WITH KEYWAY

7000, 8020, 8060, 8500, 9000, M, T & TP SERIES
FITS 1/4-40 BUSHING

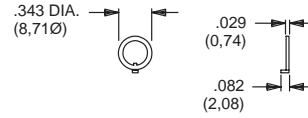

PART NO.
753700201 NICKEL PLATED WITH KEYWAY
753700264 BLACK WITH KEYWAY

7000, 8500 & 9000 SERIES
FITS 15/32 BUSHING

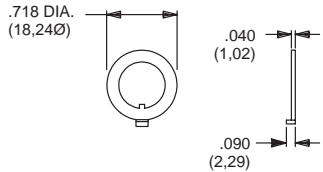

PART NO.
707200201 NICKEL PLATED WITH KEYWAY
707200264 BLACK WITH KEYWAY

7000, 8020, 8060, 8500, 9000, M, T & TP SERIES
FITS 1/4-40 BUSHING

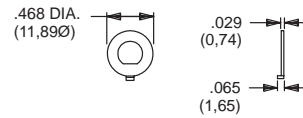

PART NO.
757200201 NICKEL PLATED WITH FLAT
757200264 BLACK WITH FLAT

7000, 8020 & 8060 SERIES
FITS M6P2 METRIC BUSHING

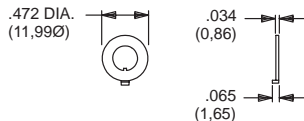

PART NO.
791800201 NICKEL PLATED WITH KEYWAY
791800264 BLACK WITH KEYWAY

7000, 8020, 8060, 8500, 9000, M, T & TP SERIES
FITS 1/4-40 BUSHING



PART NO.
757300201 NICKEL PLATED WITH FLAT
757300264 BLACK WITH FLAT

MATERIAL

Brass, nickel plated standard. Other finishes available, consult Customer Service Center.



LOCKWASHERS

FITS 10-48 BUSHING



PART NO.

465200202 NICKEL PLATED

FITS 15/32 BUSHING



PART NO.

700302202 NICKEL PLATED
700302264 BLACK

FITS 1/4-40 BUSHING



PART NO.

700303202 NICKEL PLATED
700303264 BLACK

A, BY, GY, H, W, Y & YL SERIES
FITS 3/4 DIA. BUSHING



PART NO.

175050200 NICKEL PLATED

MATERIAL
Steel; Finish: Zinc plate

A SERIES
FITS 3/8 DIA. THREAD



PART NO.

472800202

MATERIAL
Steel; Finish: Zinc plate

MATERIAL

Steel, nickel plated standard. Other finishes available, consult Customer Service Center.

MOUNTING CLIP

A, BY, GY, H, P, W, Y & YL SERIES



PART NO.

175050300

MATERIAL
Steel; Finish: Nickel or bright zinc plate

NUTS (DRESS)

Y, H & A SERIES



PART NO.

- 531300201** NICKEL PLATE
- 531300535** POLISHED NICKEL PLATE
- 175052745** GLOSS BLACK PLATE

T & TP SERIES



PART NO.

- 465701201** NICKEL PLATED
- 465701264** BLACK

8020, 8060, 8500 & TP SERIES



PART NO.

- 580700201** NICKEL PLATED

8020, 8060, E010 & TP SERIES



PART NO.

- 702501201** NICKEL PLATED
- 702501264** BLACK

7000, 8020, 8060, 8500, 9000, E, E010, T & TP SERIES



PART NO.

- 709901201** NICKEL PLATED
- 709901215** SATIN CHROME
- 709901264** BLACK

FOR SERIES

7000, 8020, 8060, 8500, 9000, E, E010, T, TP

7000, 8020, 8060, 8500, 9000, E, E010, T & TP SERIES



PART NO.

- 776001201** NICKEL PLATED
- 776002231** BLACK

FOR SERIES

7000, 8020, 8060, 8500, 9000, E, E010, T, TP

7000, 8020, 8060, 8500, 9000, E, E010, T & TP SERIES

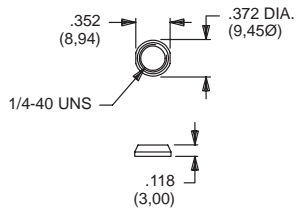

PART NO.

- 780701201** NICKEL PLATED
- 780701215** SATIN CHROME
- 780701264** BLACK

8500 SERIES



PART NO.

- 498800201** NICKEL PLATED

7000 SERIES, T2P ACTUATOR



PART NO.

- 605300201** NICKEL PLATED

MATERIAL

Brass, nickel plated standard. Other finishes available, consult Customer Service center.

NUTS (DRESS)

7000, 8500 & 9000 SERIES

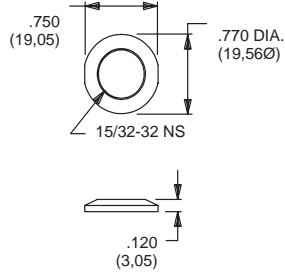

PART NO.

- 895101201 NICKEL PLATED
- 895101264 BLACK

7000, 8020 & 8060 SERIES



PART NO.

- 709903201 NICKEL PLATED
- 709903264 BLACK

MATERIAL

Brass, nickel plated standard. Other finishes available, consult Customer Service center.

NUTS (KNURLED)

7000, 8020, 8060, 8500, 9000, T & TP SERIES

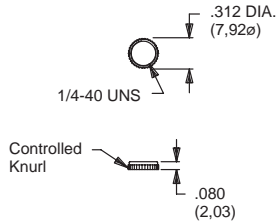

PART NO.

- 778000201 NICKEL PLATED
- 778000264 BLACK

7000, 8020, 8060, 8500, 9000, E, E010, T & TP SERIES

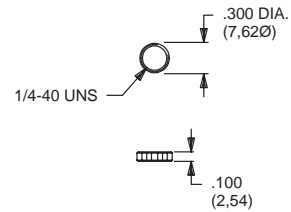

PART NO.

- 778600201 NICKEL PLATED
- 778600224 BLACK

7000, 8020, 8060, 8500, 9000, T & TP SERIES
FITS GULMITE #12 SOCKET & WRENCH 8942-02-201

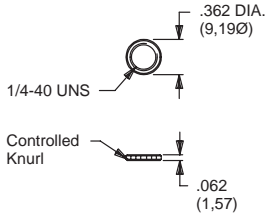

PART NO.

- 796901201 NICKEL PLATED
- 796901264 BLACK

7000, 8500 & 9000 SERIES



PART NO.

- 471300201 NICKEL PLATED
- 471300264 BLACK

7000, 8020 & 8060 SERIES



PART NO.

- 483200201 NICKEL PLATED

MATERIAL

Brass, nickel plated standard. Other finishes available, consult Customer Service center.

NUTS (MOUNTING)

8600 SERIES



PART NO.

775200201 NICKEL PLATED
775200264 BLACK

T & TP SERIES



PART NO.

464900201 NICKEL PLATED
464900264 BLACK

M SERIES

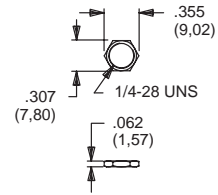

PART NO.

477100201 NICKEL PLATED

E & E010 SERIES



PART NO.

540400201 NICKEL PLATED
540400264 BLACK

7000, 8020, 8060, 8500, 9000, T & TP SERIES



PART NO.

700201201 NICKEL PLATED
700201264 BLACK

7000, 8500 & 9000 SERIES

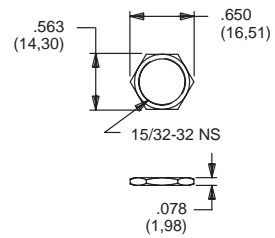

PART NO.

707100201 NICKEL PLATED
707100215 SATIN CHROME
707100264 BLACK

7000, 8020 & 8060 SERIES



PART NO.

791600201 NICKEL PLATED
791600264 BLACK

A, BY, GY, H, P, W, Y & YL SERIES



PART NO.

175050700

MATERIAL
 Steel; Finish: Zinc plate

A SERIES



PART NO.

472706201

MATERIAL
 Zinc; Finish: Nickel plate

A SERIES



PART NO.

495100201

H & R SERIES



PART NO.

175000100

MATERIAL
 Brass; Finish: Zinc electro & clear bright chromate

F SERIES



PART NO.

175020201

MATERIAL

Brass, nickel plated standard. Other finishes available, consult Customer Service Center.

NUTS (MOUNTING)

YM SERIES

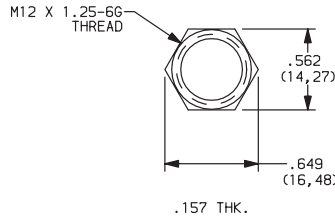

PART NO.
179090123

MATERIAL

Brass, nickel plated standard. Other finishes available, consult Customer Service Center.

RECESSED BRACKET

D & DM SERIES



PART NO.
057090100

MATERIAL
6/6 Nylon

ROCKER AND LEVER HANDLE SWITCH-PANEL MOUNTING HARDWARE

Panel mounting hardware for rocker and lever handle switches is available separately. Mounting hardware consists of two screws, two nuts, two standoffs and two lockwashers per switch, and is available for panel thicknesses of 1/16, 3/32 and 1/8 inch. See part numbers below.



7000 Series: J1, J2, J54, J64, J94 actuators.
T Series: J1, J6 actuators.

PART NO.	PANEL THK.	STANDOFF LENGTH
761101000	1/16 IN. (1,59)	.295 (7,49)
761102000	3/32 IN (2,38)	.264 (6,71)
761103000	1/8 IN. (3,18)	.233 (5,92)

9000 Series: J1, J2, J3, J50, J60, J90 actuators.
7000 Series: J3 actuators.

PART NO.	PANEL THK.	STANDOFF LENGTH
770601000	1/16 IN. (1,59)	.295 (7,49)
770602000	3/32 IN (2,38)	.264 (6,71)
770603000	1/8 IN. (3,18)	.233 (5,92)

7000 & 9000 Series: J4, J5 actuators.

PART NO.	PANEL THK.	STANDOFF LENGTH
775001000	1/16 IN. (1,59)	.375 (9,53)
775002000	3/32 IN (2,38)	.344 (8,74)
775003000	1/8 IN. (3,18)	.312 (7,92)

7000 & 9000 Series: J10 actuators.

PART NO.	PANEL THK.	STANDOFF LENGTH
770701000	1/16 IN. (1,59)	.295 (7,49)
770702000	3/32 IN (2,38)	.264 (6,71)
770703000	1/8 IN. (3,18)	.233 (5,92)

MATERIAL

Screws, nuts, lockwashers: Stainless steel. Standoffs: Nylon, standard Aluminum available, consult Customer Service Center.

ROCKER AND LEVER HANDLE ACTUATORS

ET SERIES
J1 ACTUATOR



PART NO.

261A01000 WHITE
261A02263 BLACK
261A03000 RED

T SERIES
J1 ACTUATOR



PART NO.

468001000 WHITE
468002263 BLACK
468003000 RED

7000, 9000 & E SERIES
J1, J11, J15, J16 ACTUATORS



PART NO.

760201000 WHITE
760202263 BLACK
760203000 RED

7000, 9000 & E SERIES
J2, J21, J25, J26 ACTUATORS



PART NO.

760501000 WHITE
760502263 BLACK
760503000 RED

7000, 9000 & E SERIES
J3, J37 ACTUATORS



PART NO.

766601000 WHITE
766602263 BLACK
766603000 RED

7000, 9000 & E SERIES
J4, J47 ACTUATORS



PART NO.

773301000 WHITE
773302263 BLACK
773303000 RED

7000, 9000 & E SERIES
J5, J57 ACTUATORS



PART NO.

791201000 WHITE
791202263 BLACK
791203000 RED

7000, 9000 & E SERIES
J50, J51, J52, J53, J54 ACTUATORS



PART NO.

628301000 WHITE
628302263 BLACK
628303000 RED

ET SERIES,
J6 ACTUATOR



PART NO.

260A01000 WHITE
260A02263 BLACK
260A03000 RED (For Hi Temp, Consult Factory)

T SERIES
J6 ACTUATOR



PART NO.

468101000 WHITE
468102263 BLACK
468103000 RED

7000, 9000 & E SERIES
J60, J61, J62, J63, J64 ACTUATORS



PART NO.

598101000 WHITE
613802263 BLACK
598103000 RED

7000 SERIES
J76 ACTUATOR

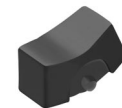

PART NO.

725A01000 WHITE
725A02263 BLACK
725A03000 RED

MATERIAL

Nylon. Finish: Matte. Special colors, custom markings available, consult Customer Service Center.



ROCKER AND LEVER HANDLE ACTUATORS

7000, 9000 & E SERIES
J8 ACTUATOR



PART NO.
488701000 WHITE
488702263 BLACK
488703000 RED

7000, 9000 & E SERIES
J90, J91, J92, J93, J94 ACTUATORS



PART NO.
598001000 WHITE
598002263 BLACK
598003000 RED

7000 & 9000 SERIES
J10, J19 ACTUATORS



PART NO.
769501000 WHITE
769502263 BLACK
769503000 RED

7000 & 9000 SERIES
L41 ACTUATOR



PART NO.
481001000 WHITE
481002263 BLACK
481003000 RED

7000 & 9000 SERIES
L42 ACTUATOR



PART NO.
481101000 WHITE
481102263 BLACK
481103000 RED

9000 SERIES
L43 ACTUATOR



PART NO.
481201000 WHITE
481202263 BLACK
481203000 RED

MATERIAL

Nylon. Finish: Matte. Special colors, custom markings available, consult Customer Service Center.

SPLASH CAPS

L SERIES

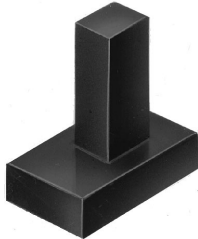

PART NO.
120100200 Fits 'MS' mounting style,
LXX1 & LXX2 models only.
MATERIAL
 6/6 Nylon

L SERIES



PART NO.
120100300 Fits 'MV' mounting style,
LX1X models only.
MATERIAL
 6/6 Nylon

L SERIES



PART NO.
120100400 Fits 'MA' mounting style,
LXX3 models only.
MATERIAL
 6/6 Nylon

V SERIES

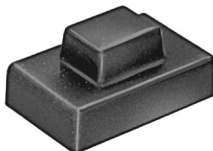

PART NO.
128000100 Fits 'MS' mounting style.
MATERIAL
 6/6 Nylon

SD SERIES



PART NO.
678500000 NATURAL
678501000 BLACK
MATERIAL
 6/6 Nylon

STOP RINGS

A SERIES



PART NO.

472900201

MATERIAL

Brass; Finish: Nickel plated

M SERIES

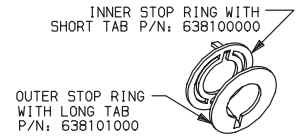

INNER STOP RING WITH SHORT TAB P/N: 638100000
OUTER STOP RING WITH LONG TAB P/N: 638101000

PART NO.

638100000 INNER-W/SHORT TAB
638101000 OUTER-W/LONG TAB

One each required for setting stops.

SWITCH ENCLOSURES

These enclosures make it easy to install HB and HG Series switches with electrical conduit, electrical tubing or armored cable. The switch is inserted through the open top of the enclosure and is secured by two screws (furnished). The lower section of the enclosure is completely removable and gives free access to the switch terminals. Switches having either the flat base or step base can be used. Switches must be ordered separately.

TC-2 THRU-BOLT MOUNTING, 1/2-14 NPSM CONDUIT THREAD (Straight Thread)

TC-4 THRU-BOLT MOUNTING, 1/2-14 NPT CONDUIT THREAD (Tapered Thread)

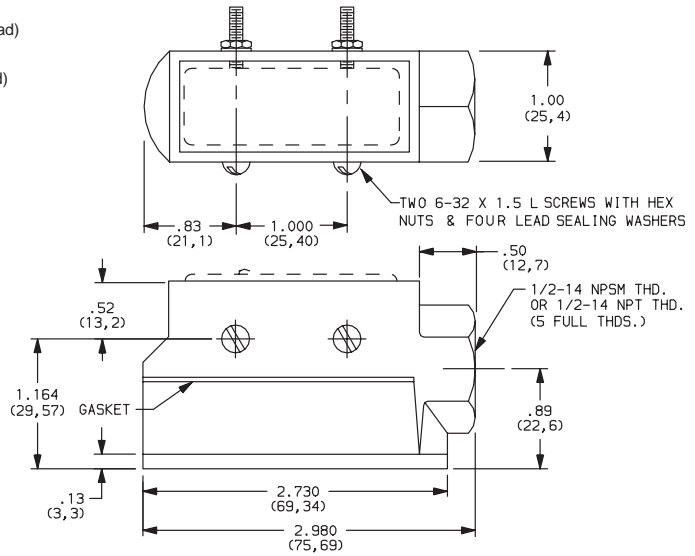

TC-3 FLANGE MOUNTING, 1/2-14 NPSM CONDUIT THREAD (Straight Thread)

TC-5 FLANGE MOUNTING, 1/2-14 NPT CONDUIT THREAD (Tapered Thread)

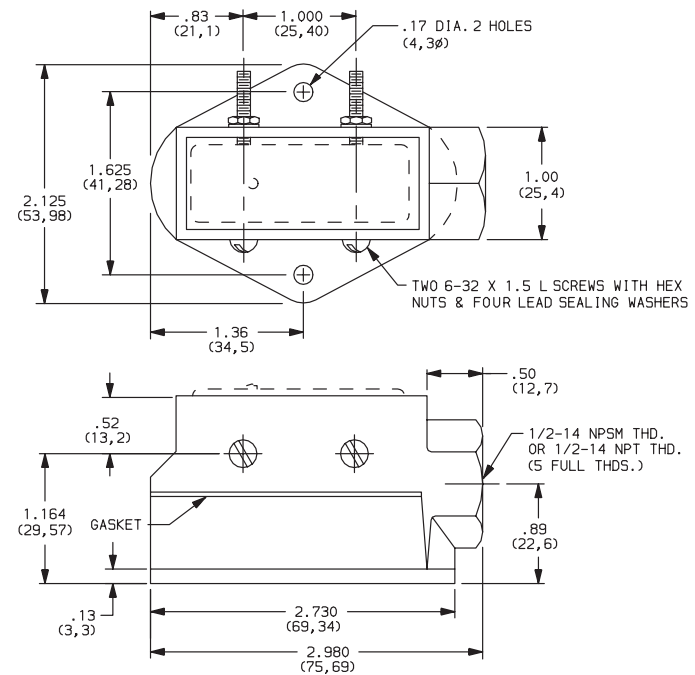

TERMINAL COVERS

These terminal covers are available with HB and HG Series switches. They are made of molded phenolic, with knockouts that permit wires to be brought in at convenient points. They are held in place by the switch mounting screws.

TC-1

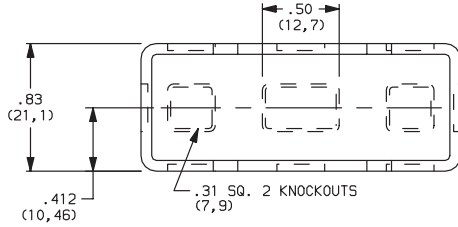

WRENCHES



PART NO.
465300201
FITS NUT PART NUMBERS
 4649XXXXX, 4657XXXXX



PART NO.
778500201
FITS NUT PART NUMBERS
 7002XXXXX, 7099XXXXX
 7807XXXXX, 7916XXXXX



PART NO.
481500201
FITS NUT PART NUMBERS
 7780XXXXX, 4832XXXXX



PART NO.
894200201
FITS NUT PART NUMBERS
 7969XXXXX



C&K Hardware

Miscellaneous Components, Hardware & Technical Data

MISCELLANEOUS

<p>STOP PINS</p> <div style="text-align: center; margin: 20px 0;">  </div> <p>PART NO.</p> <p>402900000 3 SERIES 657800000 3P SERIES 537100000 M SERIES 587300000 SF/SR & S2 SERIES</p>	<p>3 SERIES CONNECTOR</p> <div style="text-align: center; margin: 20px 0;">  </div> <p>PART NO.</p> <p>605A00000 PC Fits 0, 1, 4, 5 terminations only. 605A02000 SOLDER LUG</p>	<p>3P SERIES CONNECTOR</p> <div style="text-align: center; margin: 20px 0;">  </div> <p>PART NO.</p> <p>630000000 Fits 0, 1 terminations only.</p>
<p>M SERIES WASHERS</p> <div style="text-align: center; margin: 20px 0;">  </div> <p>PART NO.</p> <p>586800000 RUBBER PANEL SEAL 537202000 ADHESIVE MYLAR RETAINS STOP PINS</p>	<p>Z3 TERMINATION FEMALE CONNECTOR</p> <div style="text-align: center; margin: 20px 0;">  </div> <p>PART NO.</p> <p>530100000</p>	<p>KS SERIES LED SUPPORT</p> <div style="text-align: center; margin: 20px 0;">  </div> <p>PART NO.</p> <p>540300000</p>



Mouser Electronics

Authorized Distributor

Click to View Pricing, Inventory, Delivery & Lifecycle Information:

C&K Switches:

[801801000](#) [801803000](#) [780701201](#) [537100000](#) [709901201](#) [580700201](#) [175050700](#) [707200201](#) [780701215](#)
[479603000](#) [476803000](#) [700303202](#) [700201201](#) [785103000](#) [798203000](#) [484603000](#) [586800000](#) [464900201](#)
[465802000](#) [477100201](#) [540400201](#) [753700201](#) [459102000](#) [530100000](#) [894102000](#) [121000102](#) [778500201](#)
[638100000](#) [638101000](#) [752701000](#) [472706201](#) [895101201](#) [896802000](#) [708901000](#) [896803000](#) [894103000](#)
[472800202](#) [894101000](#) [538702000](#) [708905000](#) [708906000](#) [761103000](#) [776002231](#) [801805000](#) [801807000](#)
[700302202](#) [121000101](#) [767B00201](#) [452602263](#) [706202000](#) [708903000](#) [585A01000](#) [707100201](#) [540400A56](#)
[708907000](#)

Компания «Океан Электроники» предлагает заключение долгосрочных отношений при поставках импортных электронных компонентов на взаимовыгодных условиях!

Наши преимущества:

- Поставка оригинальных импортных электронных компонентов напрямую с производств Америки, Европы и Азии, а так же с крупнейших складов мира;
- Широкая линейка поставок активных и пассивных импортных электронных компонентов (более 30 млн. наименований);
- Поставка сложных, дефицитных, либо снятых с производства позиций;
- Оперативные сроки поставки под заказ (от 5 рабочих дней);
- Экспресс доставка в любую точку России;
- Помощь Конструкторского Отдела и консультации квалифицированных инженеров;
- Техническая поддержка проекта, помощь в подборе аналогов, поставка прототипов;
- Поставка электронных компонентов под контролем ВП;
- Система менеджмента качества сертифицирована по Международному стандарту ISO 9001;
- При необходимости вся продукция военного и аэрокосмического назначения проходит испытания и сертификацию в лаборатории (по согласованию с заказчиком);
- Поставка специализированных компонентов военного и аэрокосмического уровня качества (Xilinx, Altera, Analog Devices, Intersil, Interpoint, Microsemi, Actel, Aeroflex, Peregrine, VPT, Syfer, Eurofarad, Texas Instruments, MS Kennedy, Miteq, Cobham, E2V, MA-COM, Hittite, Mini-Circuits, General Dynamics и др.);

Компания «Океан Электроники» является официальным дистрибьютором и эксклюзивным представителем в России одного из крупнейших производителей разъемов военного и аэрокосмического назначения «JONHON», а так же официальным дистрибьютором и эксклюзивным представителем в России производителя высокотехнологичных и надежных решений для передачи СВЧ сигналов «FORSTAR».



JONHON

«JONHON» (основан в 1970 г.)

Разъемы специального, военного и аэрокосмического назначения:

(Применяются в военной, авиационной, аэрокосмической, морской, железнодорожной, горно- и нефтедобывающей отраслях промышленности)

«FORSTAR» (основан в 1998 г.)

ВЧ соединители, коаксиальные кабели, кабельные сборки и микроволновые компоненты:

(Применяются в телекоммуникациях гражданского и специального назначения, в средствах связи, РЛС, а так же военной, авиационной и аэрокосмической отраслях промышленности).



Телефон: 8 (812) 309-75-97 (многоканальный)

Факс: 8 (812) 320-03-32

Электронная почта: ocean@oceanchips.ru

Web: <http://oceanchips.ru/>

Адрес: 198099, г. Санкт-Петербург, ул. Калинина, д. 2, корп. 4, лит. А