

## AUXILIARY ACTUATORS

Easy to assemble auxiliary actuators for the MM Series provides the end-user with the capability to operate the switch with force not directly in line with the operating button. Actuators are available in either the plain-leaf or roller-leaf style. Each actuator kit consists of the stainless steel spring-leaf with an integral side mounting plate, flexible insulator, two (2) #2-56 x 7/16" roundhead screws, with lockwashers and hex nuts. Actuator and hardware are supplied unassembled. Specially formed auxiliary actuators are available, consult Customer Service Center.

### ALS-1 LEAF



#### SWITCH CHARACTERISTICS

OPERATING FORCE (MAX)	$\frac{\text{oz}}{\text{grams}}$	$\frac{6}{170}$
RELEASE FORCE (MIN)	$\frac{\text{oz}}{\text{grams}}$	$\frac{2}{56}$
DIFFERENTIAL TRAVEL (MAX)	$\frac{\text{in}}{\text{(mm)}}$	$\frac{.025}{(0,64)}$
PRETRAVEL (MAX)	$\frac{\text{in}}{\text{(mm)}}$	$\frac{.110}{(2,79)}$
OVERTRAVEL (MIN)	$\frac{\text{in}}{\text{(mm)}}$	$\frac{.015}{(0,38)}$

### ALS-2 LEAF (Low Motion)

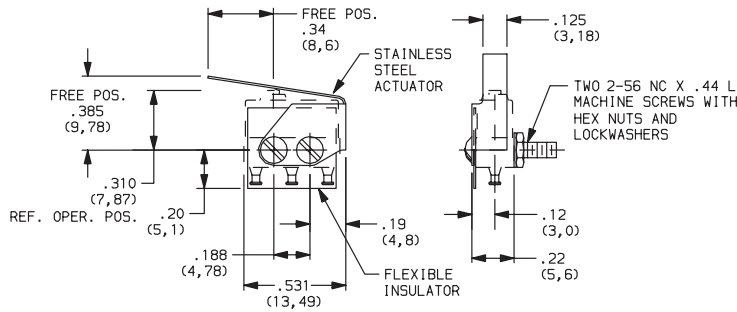

#### SWITCH CHARACTERISTICS

OPERATING FORCE (MAX)	$\frac{\text{oz}}{\text{grams}}$	$\frac{7}{198}$
RELEASE FORCE (MIN)	$\frac{\text{oz}}{\text{grams}}$	$\frac{2}{56}$
DIFFERENTIAL TRAVEL (MAX)	$\frac{\text{in}}{\text{(mm)}}$	$\frac{.025}{(0,64)}$
PRETRAVEL (MAX)	$\frac{\text{in}}{\text{(mm)}}$	$\frac{.225}{(5,72)}$
OVERTRAVEL (MIN)	$\frac{\text{in}}{\text{(mm)}}$	$\frac{.015}{(0,38)}$

### AWS-1 LEAF ROLLER



#### SWITCH CHARACTERISTICS

OPERATING FORCE (MAX)	$\frac{\text{oz}}{\text{grams}}$	$\frac{6}{170}$
RELEASE FORCE (MIN)	$\frac{\text{oz}}{\text{grams}}$	$\frac{2}{56}$
DIFFERENTIAL TRAVEL (MAX)	$\frac{\text{in}}{\text{(mm)}}$	$\frac{.025}{(0,64)}$
PRETRAVEL (MAX)	$\frac{\text{in}}{\text{(mm)}}$	$\frac{.110}{(2,79)}$
OVERTRAVEL (MIN)	$\frac{\text{in}}{\text{(mm)}}$	$\frac{.015}{(0,38)}$

### AWS-2 LEAF ROLLER (Low Motion)

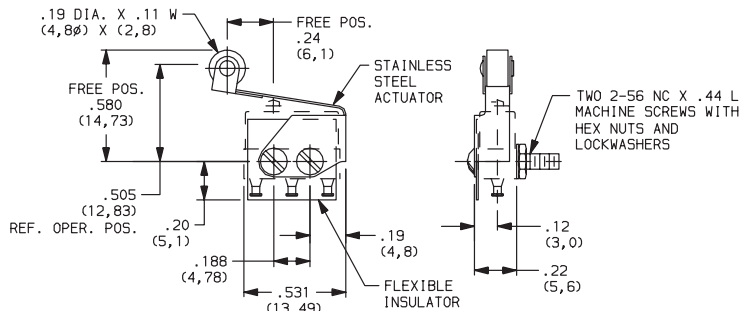

#### SWITCH CHARACTERISTICS

OPERATING FORCE (MAX)	$\frac{\text{oz}}{\text{grams}}$	$\frac{7}{198}$
RELEASE FORCE (MIN)	$\frac{\text{oz}}{\text{grams}}$	$\frac{2}{56}$
DIFFERENTIAL TRAVEL (MAX)	$\frac{\text{in}}{\text{(mm)}}$	$\frac{.025}{(0,64)}$
PRETRAVEL (MAX)	$\frac{\text{in}}{\text{(mm)}}$	$\frac{.225}{(5,72)}$
OVERTRAVEL (MIN)	$\frac{\text{in}}{\text{(mm)}}$	$\frac{.015}{(0,38)}$

AUXILIARY ACTUATORS

Basic precision HB Series switches, with any terminal style, can be used with these attachable actuators. As supplied, the actuator is not assembled to the switch; the switch must be ordered separately. The actuator can be assembled to the switch before mounting, or the actuator can be mounted on the panel or chassis and the switch installed after wiring. Assembly screws, nuts and lockwashers are furnished.

**BB-1** SEALED PLUNGER (For use with P0 actuator option.)

**BB-2** SEALED PLUNGER (For use with PS sealed actuator option.)

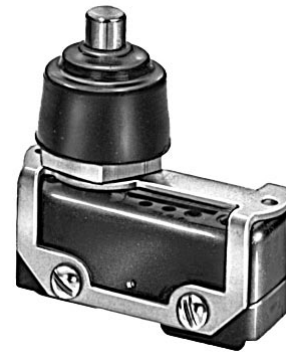
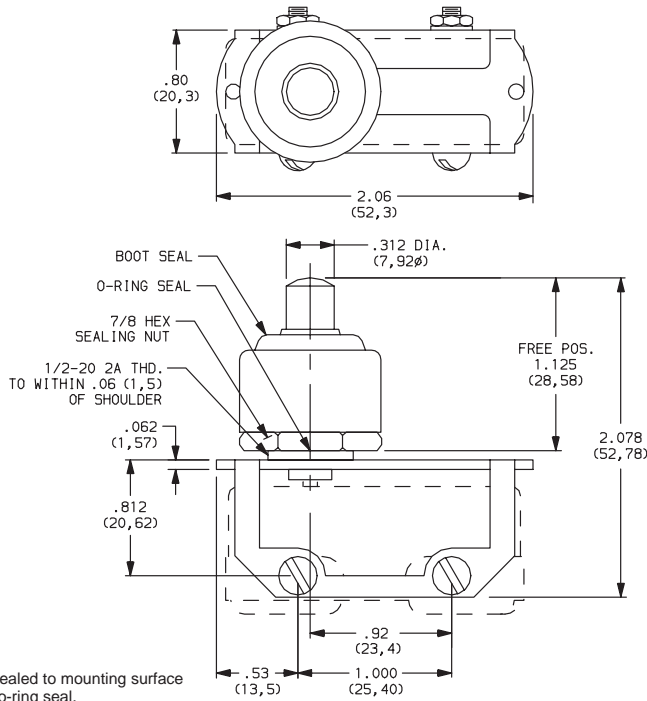

**BJ-1** OVERTRAVEL PLUNGER (For use with P0 actuator option.)

**BJ-2** OVERTRAVEL PLUNGER (For use with PS sealed actuator option.)

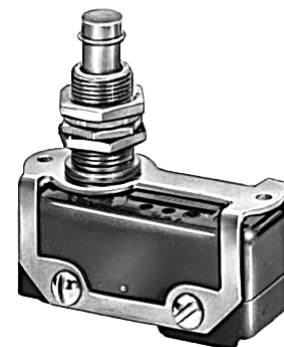
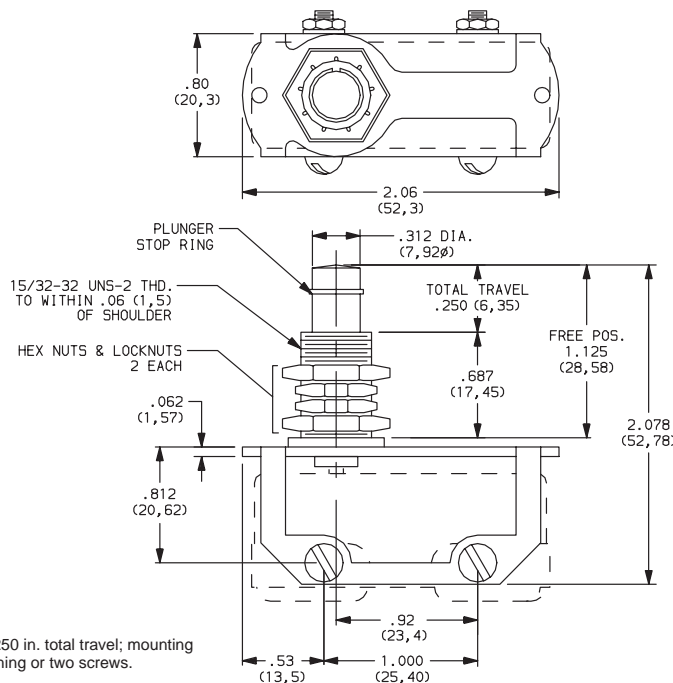

## CAPS

### EP & TP SERIES, .100" DIA. PLUNGERS



**PART NO.**

- 508101000** WHITE
- 508102000** BLACK
- 508103000** RED

### TP SERIES, .100" DIA. PLUNGERS (Recommended for S9 plunger)



**PART NO.**

- 538701000** WHITE
- 538702000** BLACK
- 538703000** RED

### EP & TP SERIES, .100" DIA. PLUNGERS



**PART NO.**

- 465801000** WHITE
- 465802000** BLACK
- 465803000** RED

### 8600 & KM33 SERIES, .106" DIA. PLUNGERS



**PART NO.**

- 785101000** WHITE
- 785102000** BLACK
- 785103000** RED

### 8020, 8060, E010, E020, KM11, L & TP SERIES, .122" DIA. PLUNGERS



**PART NO.**

- 708901000** WHITE
- 708902000** BLACK
- 708903000** RED

### 8020, 8060, E010, E020, KM11 & L SERIES, .122" DIA. PLUNGERS



**PART NO.**

- 752701000** WHITE
- 752702000** BLACK
- 752703000** RED

### 8020, 8060, E010, E020, KM11, L & TP SERIES .122" DIA. PLUNGERS



**PART NO.**

- 801801000** WHITE
- 801802000** BLACK
- 801803000** RED

### .157" DIA. PLUNGERS



**PART NO.**

- 267A01000** WHITE
- 267A02000** BLACK
- 267A03000** RED

**FOR SERIES**  
85X2T, 8534T  
Models only

**PART NO.**

- 893101000** WHITE
- 893102000** BLACK
- 893103000** RED

**FOR SERIES**  
85X1T, 8532T1,  
8533T, 8534T1 Models only

### 8020, 8050, E010, E020 & L SERIES, .122" DIA. SNAP-FITTING PLUNGERS

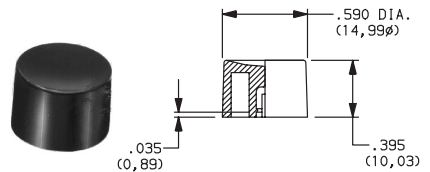

**PART NO.**

- 894001000** WHITE
- 894002000** BLACK
- 894003000** RED

### EP11 & EP12 MODELS, .100 DIA. SNAP-FITTING PLUNGERS



**PART NO.**

- 585A01000** WHITE
- 585A02000** BLACK
- 585A03000** RED

### EP11 & EP12 MODELS, .100 DIA. SNAP-FITTING PLUNGERS



**PART NO.**

- 785A01000** WHITE
- 785A02000** BLACK
- 785A03000** RED

### 8020, 8050, E010, E020 & L SERIES, .122" DIA. SNAP-FITTING PLUNGERS



**PART NO.**

- 894101000** WHITE
- 894102000** BLACK
- 894103000** RED

**MATERIAL**

Nylon. Finish: Gloss.

Special colors, custom markings available, consult Customer Service Center.

CAPS

KA SERIES, K1 CRUCIFORM ACTUATORS

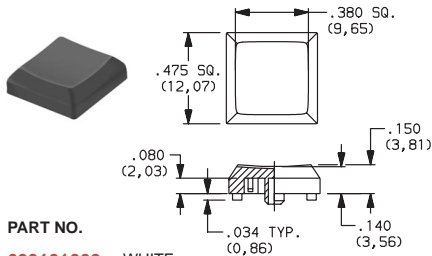

PART NO.

- 699101000 WHITE
- 699102000 BLACK
- 699103000 RED

MATERIAL

Nylon; Finish: Matte

MP SERIES

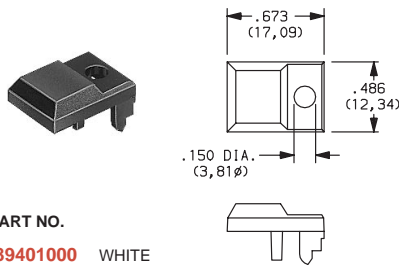

PART NO.

- 489401000 WHITE
- 489402000 BLACK
- 489403000 RED

MATERIAL

Polycarbonate-ABS blend; Finish: Matte

MP SERIES WITH TWO LED

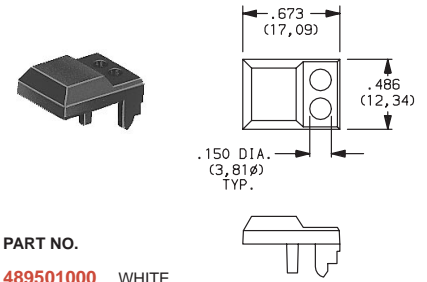

PART NO.

- 489501000 WHITE
- 489502000 BLACK
- 489503000 RED

MATERIAL

Polycarbonate-ABS blend; Finish: Matte

MP SERIES WITHOUT LED

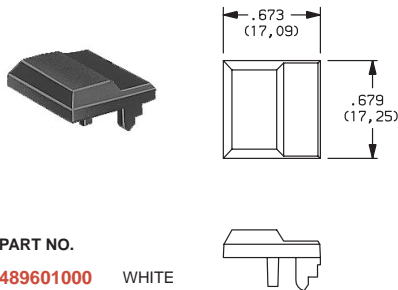

PART NO.

- 489601000 WHITE
- 489602000 BLACK
- 489603000 RED

MATERIAL

Polycarbonate-ABS blend; Finish: Matte

MP SERIES WITH LED

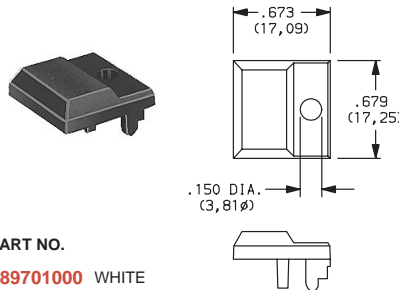

PART NO.

- 489701000 WHITE
- 489702000 BLACK
- 489703000 RED

MATERIAL

Polycarbonate-ABS blend; Finish: Matte

MP SERIES WITH TWO LED

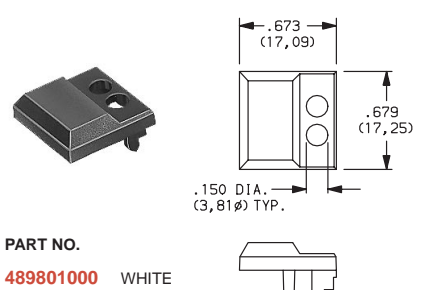

PART NO.

- 489801000 WHITE
- 489802000 BLACK
- 489803000 RED

MATERIAL

Polycarbonate-ABS blend; Finish: Matte

MP SERIES, ANTI-STATIC WITH TRANSPARENT LENS

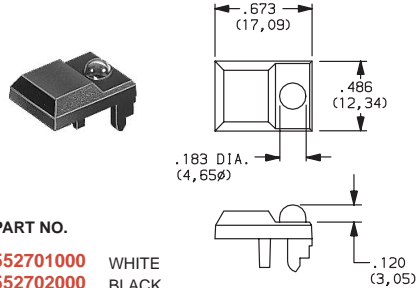

PART NO.

- 552701000 WHITE
- 552702000 BLACK
- 552703000 RED

MATERIAL

Polycarbonate-ABS blend; Finish: Matte

MP SERIES

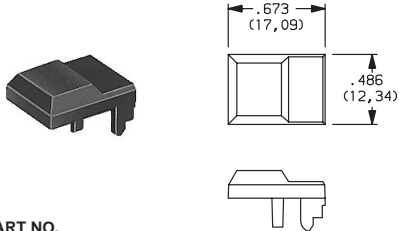

PART NO.

- 489301000 WHITE
- 489302000 BLACK
- 489303000 RED

MATERIAL

Polycarbonate-ABS blend; Finish: Matte

S SERIES, 03 ACTUATOR

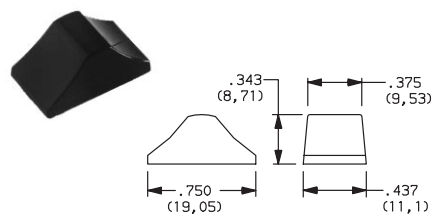

PART NO.

- 121000101 WHITE
- 121000102 BLACK
- 121000103 RED

MATERIAL

6/6 Nylon; Finish: Gloss

S SERIES, C1-C9 ACTUATORS

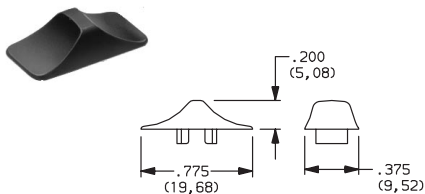

PART NO.

- 121160100 WHITE
- 121160200 BLACK
- 121160300 RED

MATERIAL

6/6 NYLON; Finish: Matte

L SERIES

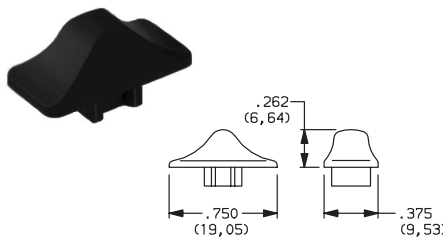

PART NO.

- 120100602 BLACK

MATERIAL

6/6 Nylon; Finish: Matte

.122" DIA. PLUNGERS

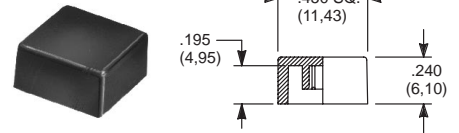

GLOSS

PART NO.

- 484601000 WHITE
- 484602000 BLACK
- 484603000 RED

FOR SERIES

8020, 8060, E010, E020, KM11, L, TP.

MATTE

PART NO.

- 798201000 WHITE
- 798202263 BLACK
- 798203000 RED

FOR SERIES

8020, 8060, E010, E020, KM11, L, TP.

Special colors, custom markings available, consult Customer Service Center.

## CAPS

### 7000, 9000 & E SERIES TOGGLE CAPS



**PART NO.**

- 896801000 WHITE
- 896802000 BLACK
- 896803000 RED

Material: Polyethylene

### 7000 SERIES TOGGLE CAPS



**PART NO.**

- 763701000 WHITE
- 763702000 BLACK
- 763703000 RED

Material: Vinyl

### 7000, 9000, E & ET SERIES TOGGLE CAPS



**PART NO.**

- 706201000 WHITE
- 706202000 BLACK
- 706203000 RED

Material: Vinyl

### 8500 SERIES, .157" DIA. PLUNGERS

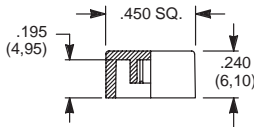

**PART NO.**

- 448901000 WHITE
- 448902000 BLACK
- 448903000 RED

### 8020 & 8060 SERIES, .122" DIA. PLUNGERS

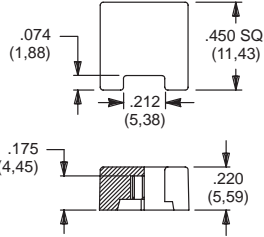
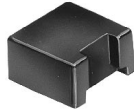

MATTE

GLOSS

**PART NO.**

- |           |           |       |
|-----------|-----------|-------|
| 459701000 | 476801000 | WHITE |
| 459702000 | 476802000 | BLACK |
| 459703000 | 476803000 | RED   |

### PN SERIES, .110" SQ. PLUNGERS

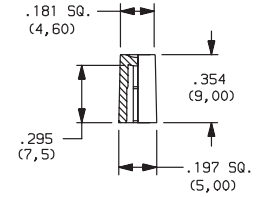

**PART NO.**

- 979A01000 WHITE
- 979A02000 BLACK
- 979A03000 RED

MATERIAL  
ABS

### PN SERIES, .130" SQ. PLUNGERS

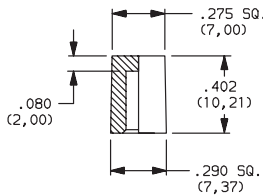

**PART NO.**

- 980A01000 WHITE
- 980A02000 BLACK
- 980A03000 RED

MATERIAL  
ABS

### PN SERIES, .110" SQ. PLUNGERS

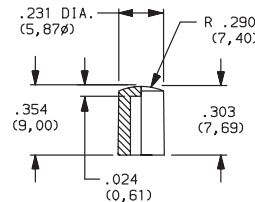

**PART NO.**

- 981A01000 WHITE
- 981A02000 BLACK
- 981A03000 RED

MATERIAL  
ABS

### PN SERIES, .130" SQ. PLUNGERS

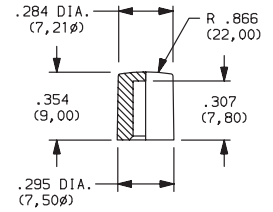

**PART NO.**

- 982A01000 WHITE
- 982A02000 BLACK
- 982A03000 RED

MATERIAL  
ABS

### PN SERIES, .130" SQ. PLUNGERS

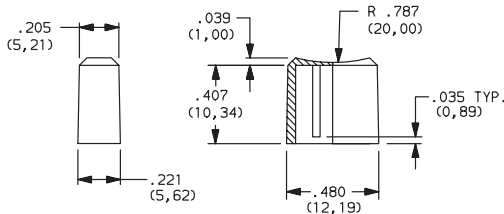

**PART NO.**

- 983A01000 WHITE
- 983A02000 BLACK
- 983A03000 RED

MATERIAL  
ABS

**MATERIAL**

Nylon. Finish: Matte or gloss.

Special colors, custom markings available, consult Customer Service Center.

**CODED SWITCHES – BLANK (INACTIVE) SECTIONS**

3U SERIES BLANK SECTION, .302" THK.  
(Replaces active section.)



PART NO.

- 123B002000 BLACK
- 123B009000 GRAY

3P SERIES BLANK SECTION, .300" THK.



PART NO.

- 663702000 BLACK
- 663709000 GRAY

S2 SERIES BLANK SECTION, .315" THK.



2127

2290

PART NO.

- 212702000 PLAIN-BLACK
- 229002000 W/RIB-BLACK

3 SERIES FRONT MOUNT, TYPE 0 & 3,  
.315" THK.



PART NO.

- 413602000 W/RIB-BLACK
- 413609000 W/RIB-GRAY
- 400502000 W/RIB & W/OUT SPRINGS-BLACK
- 400509000 W/RIB & W/OUT SPRINGS GRAY

3 SERIES FRONT MOUNT, TYPE 0 & 3,  
.315" THK.



PART NO.

- 413502000 PLAIN-BLACK
- 413509000 PLAIN-GRAY
- 400702000 PLAIN W/OUT SPRINGS-BLACK
- 400709000 PLAIN W/OUT SPRINGS GRAY

3 SERIES REAR MOUNT, TYPE 1,  
.350" THK.



4006

4008

PART NO.

- 400602000 W/RIB-BLACK
- 400609000 W/RIB-GRAY
- 400802000 PLAIN-BLACK
- 400809000 PLAIN-GRAY

3 SERIES REAR MOUNT, TYPE 2,  
.350" THK.



4734

4733

PART NO.

- 473402000 W/RIB-BLACK
- 473409000 W/RIB-GRAY
- 473302000 PLAIN-BLACK
- 473309000 PLAIN-GRAY



## CODED SWITCHES – END PLATES

S2 SERIES REAR MOUNT, MOUNTING STYLE S2S  
WITH .157" (4MM) FLANGE



PART NO.

**211702000** BLACK  
**211709000** GRAY

Two required for complete assembly.

S2 SERIES REAR MOUNT, MOUNTING STYLE S2R  
WITH .315" (8MM) FLANGE



PART NO.

**211802000** BLACK  
**211809000** GRAY

Two required for complete assembly.

S2 SERIES REAR MOUNT, MOUNTING STYLE S2T  
WITH NO FLANGE



PART NO.

**212002000** BLACK  
**212009000** GRAY

Two required for complete assembly.

S2 SERIES FRONT MOUNT, MOUNTING STYLE S2F



PART NO.

**211902000** BLACK  
**211909000** GRAY

Two required for complete assembly.

3U SERIES



LEFT-with hole      RIGHT-with pin

PART NO.

**113B02000** LEFT-BLACK  
**113B09000** LEFT-GRAY

**114B02000** RIGHT-BLACK  
**114B09000** RIGHT-GRAY

One left and one right piece required for complete assembly.

3 SERIES FRONT MOUNT, TYPE 3



PART NO.

**655702000** BLACK  
**655709000** GRAY

Two required for complete assembly.

3 SERIES FRONT MOUNT, TYPE 0



PART NO.

**413402000** BLACK  
**413409000** GRAY

Two required for complete assembly.

3 SERIES REAR MOUNT, TYPE 1



PART NO.

**400402000** BLACK  
**400409000** GRAY

Two required for complete assembly.

3 SERIES REAR MOUNT, TYPE 2



PART NO.

**473202000** BLACK  
**473209000** GRAY

Two required for complete assembly.

3P SERIES



LEFT-with hole      RIGHT-with pin

PART NO.

**623502000** LEFT-BLACK  
**623509000** LEFT-GRAY  
**623602000** RIGHT-BLACK  
**623609000** RIGHT-GRAY

One left and one right piece required for complete assembly.



**CODED SWITCHES – SPACERS**

3P SERIES, .100" THK.  
(Makes section pitch .400")



PART NO.  
663602000 BLACK  
663609000 GRAY

3 SERIES FRONT MOUNT-FITS TYPE 0 & 3,  
.185" THK. (Makes section pitch .500")



PART NO.  
410602000 BLACK  
410609000 GRAY

3 SERIES FRONT MOUNT, FITS TYPE 0 & 3,  
.078" THK. (Makes section pitch 10mm)



PART NO.  
410802000 BLACK  
410809000 GRAY

3 SERIES REAR MOUNT, FITS TYPE 1,  
.150" THK. (Makes section pitch .500")



PART NO.  
410702000 BLACK  
410709000 GRAY

3 SERIES REAR MOUNT, FITS TYPE 2,  
.150" THK. (Makes section pitch .500")



PART NO.  
473602000 BLACK  
473609000 GRAY

HARDWARE FOR FIELD ASSEMBLY-3 SERIES ONLY.

SCREWS FOR FIELD ASSEMBLY OF THUMBWHEEL SWITCHES  
(2 screws needed per assembly + 403500000 nuts)

SCREW PART NUMBER (0-80 UNF THD. SIZE)	NUMBER OF SECTIONS IN ASSEMBLY				
	FRONT MOUNTING			REAR MOUNTING	
	MTG. STYLE – 00, 30	MTG. STYLE – 03, 33	MTG. STYLE – 04, 34	MTG. STYLE – 10, 20	MTG. STYLE – 14, 24
412700000	1 – 2	1	1	1 – 2	1
412701000	3 – 4	2 – 3	2	3	2
412702000	5 – 7	4 – 5	3 – 4	4 – 6	3 – 4
412703000	8 – 10	6 – 8	5 – 6	7 – 9	5 – 6
412704000	11 – 13	9 – 10	7 – 8	10 – 12	7 – 8
412705000	14 – 16	11 – 13	9 – 10	13 – 15	9 – 10

See 3 series mounting styles, pages J-11 thru J-14.

NUT



PART NO.  
403500000  
Two nuts required per assembly and screws.

NUT DRIVER (For 403500000 nut)



PART NO.  
406100652  
Not required for assembly.  
Not supplied with sample pieces.



## FIXING SPANNERS

RAFI 15.2mm, Lumotast 75 & 8.1mm



**PART NO.**  
5.58002.0190000

**DESCRIPTION**  
Tool used to secure switch to panel.  
Tightens threaded fixing ring.

RAFIX 16



**PART NO.**  
5.58002.0340000

**DESCRIPTION**  
Tool used to secure switch to panel.  
Tightens hexagon nut.

## FRAMES

7000 & E SERIES  
J11, J21 ACTUATORS



Material: Spring Steel.

**PART NO.**  
764500223 BRIGHT CHROME  
764500252 SATIN CHROME  
764500746 BLACK ENAMEL  
764500747 WHITE ENAMEL  
764601106 RETAINING SPRING

7000 & E SERIES  
J16, J26 ACTUATORS



Material: Nylon.  
Finish: Matte.

**PART NO.**  
459101000 WHITE  
459102000 BLACK  
459103000 RED

7000, 8020, 8060 & 8500 SERIES  
J51, J61, J81, J83, J85, J86, J91 ACTUATORS



Material: Nylon.  
Finish: Matte.

**PART NO.**  
615601000 WHITE  
615602263 BLACK  
615603000 RED

J19 ACTUATOR



Material: Spring Steel.

**PART NO.**  
781000223 BRIGHT CHROME  
781000252 SATIN CHROME  
781000746 BLACK ENAMEL  
781000747 WHITE ENAMEL

7000 & 9000 SERIES  
J37, J47, J57 ACTUATORS



Material: Spring Steel.

**PART NO.**  
445400223 BRIGHT CHROME  
445400252 SATIN CHROME  
445400746 BLACK ENAMEL  
445400747 WHITE ENAMEL

7000, 8020, 8060 & 8500 SERIES  
J52, J62, J82, J84, J92 ACTUATORS



Material: Nylon.  
Finish: Matte.

**PART NO.**  
613301000 WHITE  
613302263 BLACK  
613303000 RED

J50, J60, J80, J83, J90 ACTUATORS



Material: Nylon.  
Finish: Matte or Gloss.

MATTE GLOSS  
**PART NO.** **PART NO.**  
486701000 486801000 WHITE  
486702000 486802000 BLACK  
486703000 486803000 RED

7000 SERIES  
J76 ACTUATORS



Material: Nylon.  
Finish: Matte.

**PART NO.**  
724A01000 WHITE  
724A02000 BLACK  
724A03000 RED

Special colors, custom markings available, consult Customer Service Center.



FRAMES—SEPARATE SNAP-IN

Frames snap into panel opening and are independent from switch mounting. Accurate positioning of the PC mounted switch relative to the panel opening is necessary to provide proper clearance between actuator and frame. Available in two basic styles and four panel thicknesses .047-.125 in. Material: Nylon. Finish: Matte.

TYPICAL APPLICATION

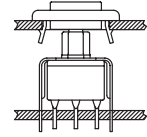

7000 & E SERIES  
J1, J2 ACTUATORS

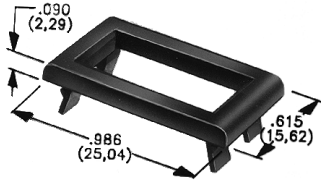

.047" (1,19) PANEL THK.    .062" (1,57) PANEL THK.    .090" (2,29) PANEL THK.    .125" (3,18) PANEL THK.

PART NO.	PART NO.	PART NO.	PART NO.	
452901000	452701000	452801000	452601000	WHITE
452902263	452702263	452802263	452602263	BLACK
452903000	452703000	452803000	452603000	RED

7000, 8020, 8060, 8500, E, E010, E020 & TP SERIES  
J50, J60, J80, J90 ACTUATORS

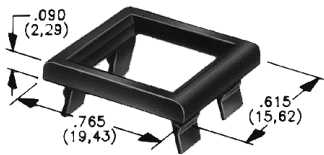

.047" (1,19) PANEL THK.    .062" (1,57) PANEL THK.    .090" (2,29) PANEL THK.    .125" (3,18) PANEL THK.

PART NO.	PART NO.	PART NO.	PART NO.	
432501000	432601000	432701000	432801000	WHITE
432502263	432602263	432702263	432802263	BLACK
432503000	432603000	432703000	432803000	RED

4529, 4527, 4528, 4526

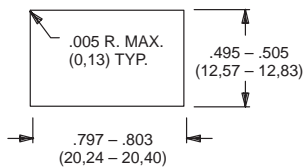

PANEL MOUNTING

4325, 4326

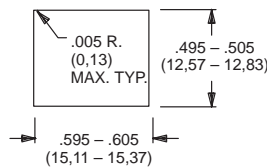

4327, 4328

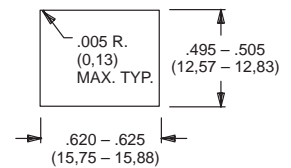

PANEL INSERTS

(WILL FIT SEPARATE SNAP-IN FRAMES FOR J50, J60, J90 ACTUATORS).

Above frames (part nos. 432XXXXXX) are also available with insert which accepts LED for indicator light assembly. Order insert separately from frame. Blank insert panel (without hole for LED) also available. LED not included, see page L-17 for LED information and recommendations.

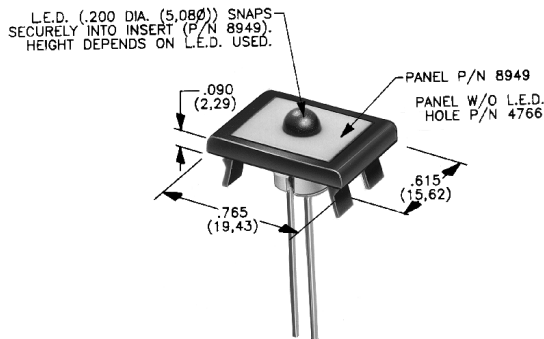

PANEL INSERT WITH HOLE FOR LED

PART NO.
894901000
894902000
894903000

BLANK PANEL INSERT WITHOUT HOLE FOR LED

PART NO.	
476601000	WHITE
476602000	BLACK
476603000	RED

Special colors, custom markings available, consult Customer Service Center.



## INSERT

### D SERIES



### PART NO.

**057190200**

### MATERIAL

Zinc nylon 6/6  
Finish: Matte

## KEYS



### 4 TUMBLER

### PART NO. (ONE KEY)

**115140126**

### MATERIAL

Brass; Finish: Nickel plate

### FOR SERIES

A, H, P, W, Y, YL  
Key Code: A126



### 5 TUMBLER

### PART NO. (ONE KEY)

### 4 TUMBLER

### PART NO. (ONE KEY)

**11599112601** WHITE  
**11599112602** BLACK  
**11599112603** RED  
**11599112600** BEIGE

### MATERIAL

Brass; Finish: Nickel plate;  
6/6 Nylon insert molded head

### FOR SERIES

A, H, P, W, Y, YL  
Key Code: A126

**11622100101** WHITE  
**11622100102** BLACK  
**11622100103** RED  
**11622100100** BEIGE

### MATERIAL

Brass; Finish: Nickel plate;  
6/6 Nylon insert molded head

### FOR SERIES

A, BY, GY, H, Y, YL  
Key Code: D001

### A, H, W, Y & YL SERIES KEY CODE: AAAA



### PART NO. (ONE KEY)

**1110801**

### MATERIAL

Zinc alloy;  
Finish: Chrome plate

### PF, PL & PM SERIES KEY CODE: 041



### PART NO. (ONE KEY)

**16916004101** WHITE  
**16916004102** BLACK  
**16916004103** RED  
**16916004100** BEIGE

### MATERIAL

Brass; Finish: Nickel plate;  
6/6 Nylon insert molded head

### YF & YM SERIES KEY CODE: 0029



### PART NO. (ONE KEY)

**119091029**

### MATERIAL

Brass; Finish: Nickel plate

### BY, GY SERIES KEY CODE: 3434



### PART NO. (ONE KEY)

**11630CKBYST**

### MATERIAL

Zinc alloy;  
Finish: Chrome plate

### A, BY, H, P, W, Y & YL SERIES Key Code: A126



### PART NO. (ONE KEY)

**16564112601** WHITE  
**16564112602** BLACK  
**16564112603** RED  
**16564112600** BEIGE

### MATERIAL

Brass; Finish: Nickel plate;  
6/6 Nylon insert molded head

### RAFI LUMOTAST 75



### PART NO. (ONE KEY)

**5.58004.7210000**

### RAFIX 16



### PART NO. (ONE KEY)

**5.58007.0010000**

LAMP EXTRACTORS



PART NO.

1.90900.0010000

FOR SERIES

RAFI 8.1 mm Illuminated Pushbutton

DESCRIPTION

Tool used to remove lamps or LEDs from switches.

PART NO.

1.90900.0020000

FOR SERIES

RAFI Lumotast® 75

DESCRIPTION

Tool used to remove lamps or LEDs from switches.

PART NO.

1.90900.0030000

FOR SERIES

RAFIX 16

DESCRIPTION

Tool used to remove lamps or LEDs from switches.

LEDS & FILAMENT LAMPS

MP SERIES

02, R2 & S2 CAP STYLES

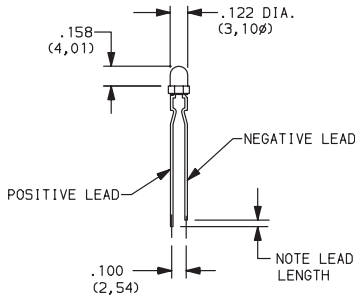

PART NO.

- 498703615 RED
- 498705615 YELLOW
- 498706615 GREEN

MP SERIES

01, A1, A2 & S1 CAP STYLES

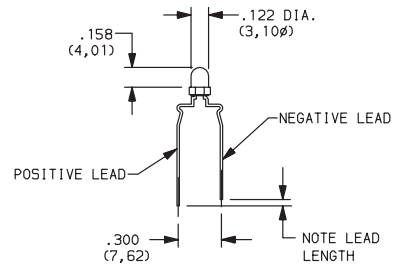

PART NO.

- 498703614 RED
- 498705614 YELLOW
- 498706614 GREEN

LED PART NUMBER	DESCRIPTION	COLOR	BASE	VOLTAGE U <sub>B</sub>	FORWARD CURRENT I <sub>F</sub>	FOR SERIES	LAMP EXTRACTOR PART NUMBER
1.90691.0260000 1.90691.0270000 1.90691.0280000	1 Chip LED	Red Green Yellow	Bi-pin T1	DC*	10 mA	8.1mm Illuminated Pushbutton	1.90900.0010000
1.90692.0010000 1.90692.0020000 1.90692.0030000	1 Chip LED	Red Green Yellow	T4.5	DC*	10 mA	Lumotast® 75	1.90900.0010000
1.90692.0450000 1.90692.0460000 1.90692.0470000	6 chip LED	Red Green Yellow	W 2x4.6 d	24 +10% AC/DC max.	12 mA	RAFIX 16	1.90900.0030000

\*Must install a suitable external series resistor.

FILAMENT LAMP	PART NUMBER	DESCRIPTION	BASE	RATED VOLTAGE	RATED CURRENT (A or mA)	RATED POWER (W)	AVERAGE OPERATING LIFE (Hrs.)	FOR SERIES	LAMP EXTRACTOR PART NUMBER
	1.90100.0210000 1.90100.0220000 1.90100.0230000	Miniature Telephone Filament Lamp	T 4.5	6 V 12 V 24 V	0.05 A 0.04 A 0.02 A	0.3 0.48 0.48	10,000 10,000 8,000	Lumotast® 75	1.90900.0020000
	1.90120.0130000 1.90120.0120000 1.90120.0110000 1.90120.0090000	Filament Lamp	W 2x4.6 d	6 V 12 V 24 V 60 V	0.20 A 0.08 A 0.04 A 0.02 A	1.2 1.2 1.2 1.2	20,000 15,000 7,000 3,300	RAFIX 16	1.90900.0030000
	1.90180.4710000 1.90180.4720000 1.90180.4730000	Indicator Lamp T1	Bi-pin	6 V 12/14 V 24/28 V	0.05 A 0.03 A 0.016 A	0.3 0.4-.56 0.4-.56	50,000 20,000 5,000	8.1 mm Illum. Pushbuttons	1.90900.0010000



## LOCKING RINGS

T & TP SERIES  
FITS 10-48 BUSHING



**PART NO.**  
**465000201** NICKEL PLATED WITH FLAT

7000, 8020, 8060, 8500, 9000, M, T & TP SERIES  
FITS 1/4-40 BUSHING



**PART NO.**  
**700701201** NICKEL PLATED WITH KEYWAY  
**700701264** BLACK WITH KEYWAY

T & TP SERIES  
FITS 10-48 BUSHING



**PART NO.**  
**465101201** NICKEL PLATED WITH KEYWAY

7000, 8020, 8060, 8500, 9000, M, T & TP SERIES  
FITS 1/4-40 BUSHING



**PART NO.**  
**753700201** NICKEL PLATED WITH KEYWAY  
**753700264** BLACK WITH KEYWAY

7000, 8500 & 9000 SERIES  
FITS 15/32 BUSHING

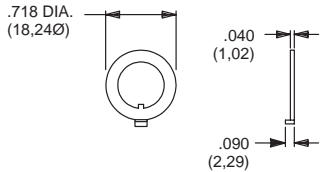

**PART NO.**  
**707200201** NICKEL PLATED WITH KEYWAY  
**707200264** BLACK WITH KEYWAY

7000, 8020, 8060, 8500, 9000, M, T & TP SERIES  
FITS 1/4-40 BUSHING



**PART NO.**  
**757200201** NICKEL PLATED WITH FLAT  
**757200264** BLACK WITH FLAT

7000, 8020 & 8060 SERIES  
FITS M6P2 METRIC BUSHING



**PART NO.**  
**791800201** NICKEL PLATED WITH KEYWAY  
**791800264** BLACK WITH KEYWAY

7000, 8020, 8060, 8500, 9000, M, T & TP SERIES  
FITS 1/4-40 BUSHING



**PART NO.**  
**757300201** NICKEL PLATED WITH FLAT  
**757300264** BLACK WITH FLAT

**MATERIAL**

Brass, nickel plated standard. Other finishes available, consult Customer Service Center.

**LOCKWASHERS**

FITS 10-48 BUSHING



PART NO.

**465200202** NICKEL PLATED

FITS 15/32 BUSHING



PART NO.

**700302202** NICKEL PLATED  
**700302264** BLACK

FITS 1/4-40 BUSHING



PART NO.

**700303202** NICKEL PLATED  
**700303264** BLACK

A, BY, GY, H, W, Y & YL SERIES  
FITS 3/4 DIA. BUSHING

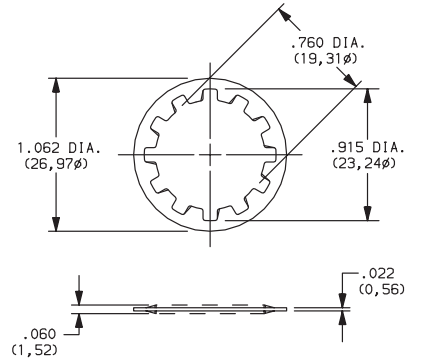

PART NO.

**175050200** NICKEL PLATED

**MATERIAL**  
Steel; Finish: Zinc plate

A SERIES  
FITS 3/8 DIA. THREAD

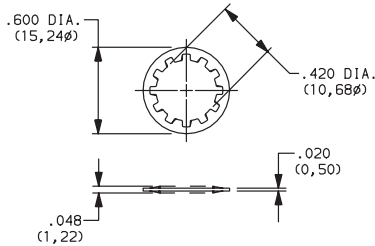

PART NO.

**472800202**

**MATERIAL**  
Steel; Finish: Zinc plate

**MATERIAL**

Steel, nickel plated standard. Other finishes available, consult Customer Service Center.

**MOUNTING CLIP**

A, BY, GY, H, P, W, Y & YL SERIES



PART NO.

**175050300**

**MATERIAL**  
Steel; Finish: Nickel or bright zinc plate

## NUTS (DRESS)

### Y, H & A SERIES



**PART NO.**

- 531300201** NICKEL PLATE
- 531300535** POLISHED NICKEL PLATE
- 175052745** GLOSS BLACK PLATE

### T & TP SERIES

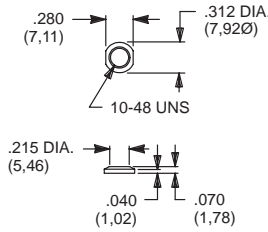

**PART NO.**

- 465701201** NICKEL PLATED
- 465701264** BLACK

### 8020, 8060, 8500 & TP SERIES

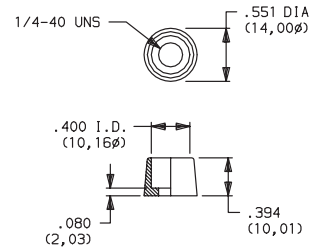

**PART NO.**

- 580700201** NICKEL PLATED

### 8020, 8060, E010 & TP SERIES



**PART NO.**

- 702501201** NICKEL PLATED
- 702501264** BLACK

### 7000, 8020, 8060, 8500, 9000, E, E010, T & TP SERIES



**PART NO.**

- 709901201** NICKEL PLATED
- 709901215** SATIN CHROME
- 709901264** BLACK

**FOR SERIES**

7000, 8020, 8060, 8500, 9000, E, E010, T, TP

### 7000, 8020, 8060, 8500, 9000, E, E010, T & TP SERIES

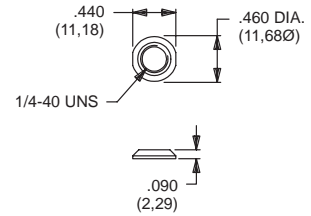

**PART NO.**

- 776001201** NICKEL PLATED
- 776002231** BLACK

**FOR SERIES**

7000, 8020, 8060, 8500, 9000, E, E010, T, TP

### 7000, 8020, 8060, 8500, 9000, E, E010, T & TP SERIES

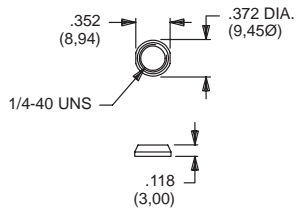

**PART NO.**

- 780701201** NICKEL PLATED
- 780701215** SATIN CHROME
- 780701264** BLACK

### 8500 SERIES



**PART NO.**

- 498800201** NICKEL PLATED

### 7000 SERIES, T2P ACTUATOR



**PART NO.**

- 605300201** NICKEL PLATED

**MATERIAL**

Brass, nickel plated standard. Other finishes available, consult Customer Service center.

**NUTS (DRESS)**

7000, 8500 & 9000 SERIES

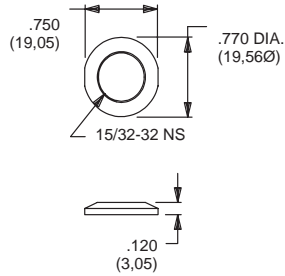

PART NO.

- 895101201 NICKEL PLATED
- 895101264 BLACK

7000, 8020 & 8060 SERIES

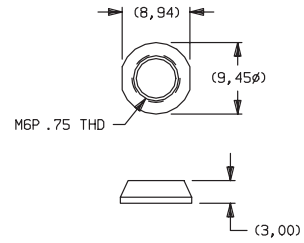

PART NO.

- 709903201 NICKEL PLATED
- 709903264 BLACK

**MATERIAL**

Brass, nickel plated standard. Other finishes available, consult Customer Service center.

**NUTS (KNURLED)**

7000, 8020, 8060, 8500, 9000, T & TP SERIES

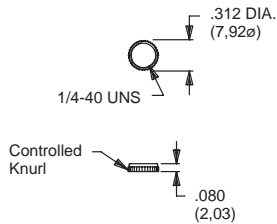

PART NO.

- 778000201 NICKEL PLATED
- 778000264 BLACK

7000, 8020, 8060, 8500, 9000, E, E010, T & TP SERIES

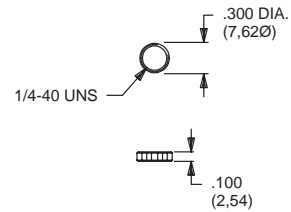

PART NO.

- 778600201 NICKEL PLATED
- 778600224 BLACK

7000, 8020, 8060, 8500, 9000, T & TP SERIES  
FITS GULMITE #12 SOCKET & WRENCH 8942-02-201

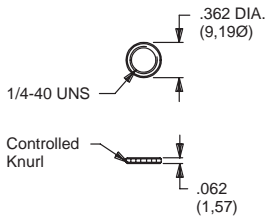

PART NO.

- 796901201 NICKEL PLATED
- 796901264 BLACK

7000, 8500 & 9000 SERIES

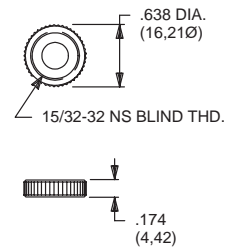

PART NO.

- 471300201 NICKEL PLATED
- 471300264 BLACK

7000, 8020 & 8060 SERIES

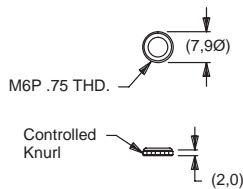

PART NO.

- 483200201 NICKEL PLATED

**MATERIAL**

Brass, nickel plated standard. Other finishes available, consult Customer Service center.



## NUTS (MOUNTING)

### 8600 SERIES

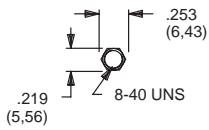

**PART NO.**

**775200201** NICKEL PLATED  
**775200264** BLACK

### T & TP SERIES



**PART NO.**

**464900201** NICKEL PLATED  
**464900264** BLACK

### M SERIES

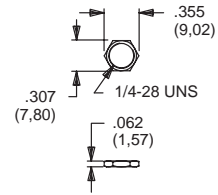

**PART NO.**

**477100201** NICKEL PLATED

### E & E010 SERIES

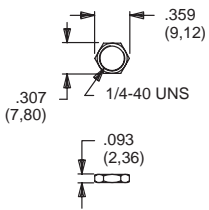

**PART NO.**

**540400201** NICKEL PLATED  
**540400264** BLACK

### 7000, 8020, 8060, 8500, 9000, T & TP SERIES



**PART NO.**

**700201201** NICKEL PLATED  
**700201264** BLACK

### 7000, 8500 & 9000 SERIES

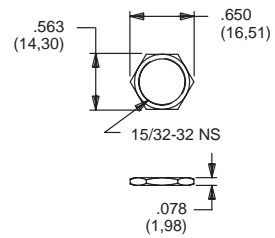

**PART NO.**

**707100201** NICKEL PLATED  
**707100215** SATIN CHROME  
**707100264** BLACK

### 7000, 8020 & 8060 SERIES



**PART NO.**

**791600201** NICKEL PLATED  
**791600264** BLACK

### A, BY, GY, H, P, W, Y & YL SERIES



**PART NO.**

**175050700**

**MATERIAL**  
 Steel; Finish: Zinc plate

### A SERIES



**PART NO.**

**472706201**

**MATERIAL**  
 Zinc; Finish: Nickel plate

### A SERIES



**PART NO.**

**495100201**

### H & R SERIES



**PART NO.**

**175000100**

**MATERIAL**  
 Brass; Finish: Zinc electro & clear bright chromate

### F SERIES



**PART NO.**

**175020201**

**MATERIAL**

Brass, nickel plated standard. Other finishes available, consult Customer Service Center.

## NUTS (MOUNTING)

YM SERIES

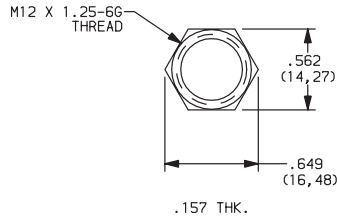

PART NO.  
**179090123**

**MATERIAL**

Brass, nickel plated standard. Other finishes available, consult Customer Service Center.

## RECESSED BRACKET

D & DM SERIES



PART NO.  
**057090100**

MATERIAL  
6/6 Nylon

## ROCKER AND LEVER HANDLE SWITCH-PANEL MOUNTING HARDWARE

Panel mounting hardware for rocker and lever handle switches is available separately. Mounting hardware consists of two screws, two nuts, two standoffs and two lockwashers per switch, and is available for panel thicknesses of 1/16, 3/32 and 1/8 inch. See part numbers below.



7000 Series: J1, J2, J54, J64, J94 actuators.  
T Series: J1, J6 actuators.

PART NO.	PANEL THK.	STANDOFF LENGTH
<b>761101000</b>	1/16 IN. (1,59)	.295 (7,49)
<b>761102000</b>	3/32 IN (2,38)	.264 (6,71)
<b>761103000</b>	1/8 IN. (3,18)	.233 (5,92)

9000 Series: J1, J2, J3, J50, J60, J90 actuators.  
7000 Series: J3 actuators.

PART NO.	PANEL THK.	STANDOFF LENGTH
<b>770601000</b>	1/16 IN. (1,59)	.295 (7,49)
<b>770602000</b>	3/32 IN (2,38)	.264 (6,71)
<b>770603000</b>	1/8 IN. (3,18)	.233 (5,92)

7000 & 9000 Series: J4, J5 actuators.

PART NO.	PANEL THK.	STANDOFF LENGTH
<b>775001000</b>	1/16 IN. (1,59)	.375 (9,53)
<b>775002000</b>	3/32 IN (2,38)	.344 (8,74)
<b>775003000</b>	1/8 IN. (3,18)	.312 (7,92)

7000 & 9000 Series: J10 actuators.

PART NO.	PANEL THK.	STANDOFF LENGTH
<b>770701000</b>	1/16 IN. (1,59)	.295 (7,49)
<b>770702000</b>	3/32 IN (2,38)	.264 (6,71)
<b>770703000</b>	1/8 IN. (3,18)	.233 (5,92)

**MATERIAL**

Screws, nuts, lockwashers: Stainless steel. Standoffs: Nylon, standard Aluminum available, consult Customer Service Center.

## ROCKER AND LEVER HANDLE ACTUATORS

ET SERIES  
J1 ACTUATOR



PART NO.

**261A01000** WHITE  
**261A02263** BLACK  
**261A03000** RED

T SERIES  
J1 ACTUATOR



PART NO.

**468001000** WHITE  
**468002263** BLACK  
**468003000** RED

7000, 9000 & E SERIES  
J1, J11, J15, J16 ACTUATORS



PART NO.

**760201000** WHITE  
**760202263** BLACK  
**760203000** RED

7000, 9000 & E SERIES  
J2, J21, J25, J26 ACTUATORS



PART NO.

**760501000** WHITE  
**760502263** BLACK  
**760503000** RED

7000, 9000 & E SERIES  
J3, J37 ACTUATORS



PART NO.

**766601000** WHITE  
**766602263** BLACK  
**766603000** RED

7000, 9000 & E SERIES  
J4, J47 ACTUATORS



PART NO.

**773301000** WHITE  
**773302263** BLACK  
**773303000** RED

7000, 9000 & E SERIES  
J5, J57 ACTUATORS



PART NO.

**791201000** WHITE  
**791202263** BLACK  
**791203000** RED

7000, 9000 & E SERIES  
J50, J51, J52, J53, J54 ACTUATORS



PART NO.

**628301000** WHITE  
**628302263** BLACK  
**628303000** RED

ET SERIES,  
J6 ACTUATOR



PART NO.

**260A01000** WHITE  
**260A02263** BLACK  
**260A03000** RED For Hi Temp, Consult Factory)

T SERIES  
J6 ACTUATOR



PART NO.

**468101000** WHITE  
**468102263** BLACK  
**468103000** RED

7000, 9000 & E SERIES  
J60, J61, J62, J63, J64 ACTUATORS



PART NO.

**598101000** WHITE  
**613802263** BLACK  
**598103000** RED

7000 SERIES  
J76 ACTUATOR



PART NO.

**725A01000** WHITE  
**725A02263** BLACK  
**725A03000** RED

### MATERIAL

Nylon. Finish: Matte. Special colors, custom markings available, consult Customer Service Center.



**ROCKER AND LEVER HANDLE ACTUATORS**

7000, 9000 & E SERIES  
J8 ACTUATOR



**PART NO.**  
**488701000** WHITE  
**488702263** BLACK  
**488703000** RED

7000, 9000 & E SERIES  
J90, J91, J92, J93, J94 ACTUATORS



**PART NO.**  
**598001000** WHITE  
**598002263** BLACK  
**598003000** RED

7000 & 9000 SERIES  
J10, J19 ACTUATORS



**PART NO.**  
**769501000** WHITE  
**769502263** BLACK  
**769503000** RED

7000 & 9000 SERIES  
L41 ACTUATOR



**PART NO.**  
**481001000** WHITE  
**481002263** BLACK  
**481003000** RED

7000 & 9000 SERIES  
L42 ACTUATOR



**PART NO.**  
**481101000** WHITE  
**481102263** BLACK  
**481103000** RED

9000 SERIES  
L43 ACTUATOR



**PART NO.**  
**481201000** WHITE  
**481202263** BLACK  
**481203000** RED

**MATERIAL**

Nylon. Finish: Matte. Special colors, custom markings available, consult Customer Service Center.

**SPLASH CAPS**

L SERIES

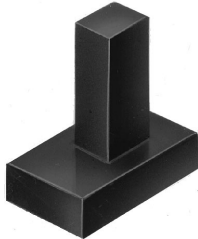

**PART NO.**  
**120100200** Fits 'MS' mounting style,  
LXX1 & LXX2 models only.  
**MATERIAL**  
 6/6 Nylon

L SERIES



**PART NO.**  
**120100300** Fits 'MV' mounting style,  
LX1X models only.  
**MATERIAL**  
 6/6 Nylon

L SERIES



**PART NO.**  
**120100400** Fits 'MA' mounting style,  
LXX3 models only.  
**MATERIAL**  
 6/6 Nylon

V SERIES

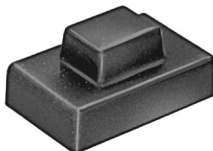

**PART NO.**  
**128000100** Fits 'MS' mounting style.  
**MATERIAL**  
 6/6 Nylon

SD SERIES



**PART NO.**  
**678500000** NATURAL  
**678501000** BLACK  
**MATERIAL**  
 6/6 Nylon

## STOP RINGS

### A SERIES



### PART NO.

**472900201**

### MATERIAL

Brass; Finish: Nickel plated

### M SERIES

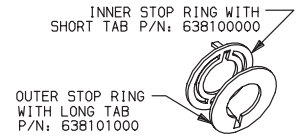

### PART NO.

**638100000** INNER-W/SHORT TAB  
**638101000** OUTER-W/LONG TAB

One each required for setting stops.

## SWITCH ENCLOSURES

These enclosures make it easy to install HB and HG Series switches with electrical conduit, electrical tubing or armored cable. The switch is inserted through the open top of the enclosure and is secured by two screws (furnished). The lower section of the enclosure is completely removable and gives free access to the switch terminals. Switches having either the flat base or step base can be used. Switches must be ordered separately.

**TC-2** THRU-BOLT MOUNTING, 1/2-14 NPSM CONDUIT THREAD (Straight Thread)

**TC-4** THRU-BOLT MOUNTING, 1/2-14 NPT CONDUIT THREAD (Tapered Thread)

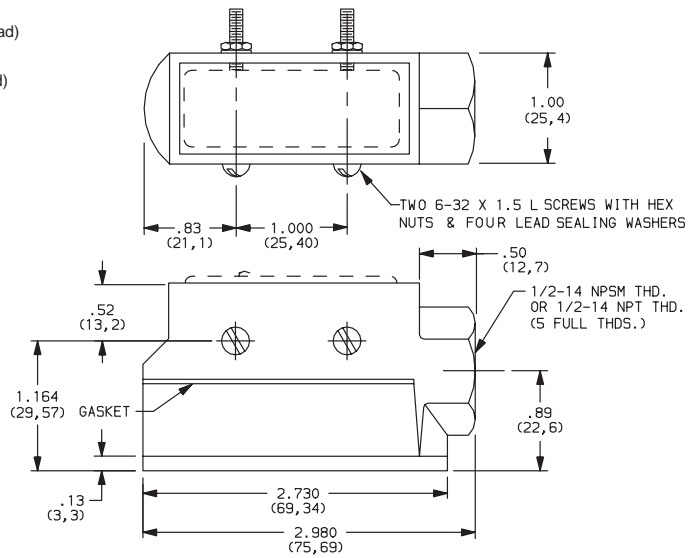

**TC-3** FLANGE MOUNTING, 1/2-14 NPSM CONDUIT THREAD (Straight Thread)

**TC-5** FLANGE MOUNTING, 1/2-14 NPT CONDUIT THREAD (Tapered Thread)

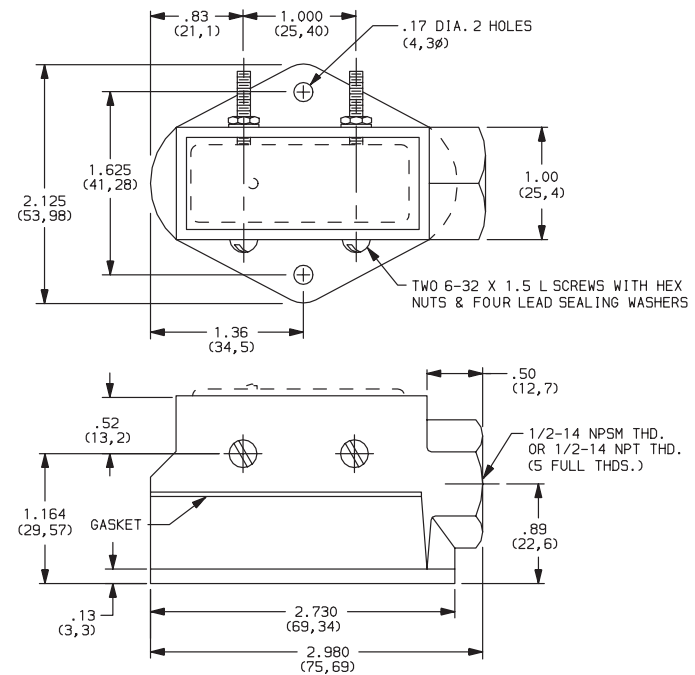

**TERMINAL COVERS**

These terminal covers are available with HB and HG Series switches. They are made of molded phenolic, with knockouts that permit wires to be brought in at convenient points. They are held in place by the switch mounting screws.

**TC-1**

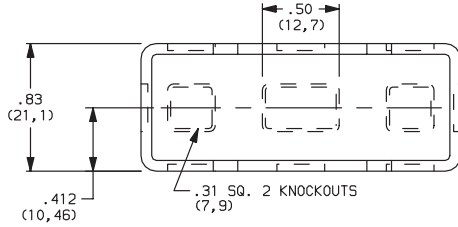

**WRENCHES**



**PART NO.**  
**465300201**  
**FITS NUT PART NUMBERS**  
 4649XXXXX, 4657XXXXX



**PART NO.**  
**778500201**  
**FITS NUT PART NUMBERS**  
 7002XXXXX, 7099XXXXX  
 7807XXXXX, 7916XXXXX



**PART NO.**  
**481500201**  
**FITS NUT PART NUMBERS**  
 7780XXXXX, 4832XXXXX



**PART NO.**  
**894200201**  
**FITS NUT PART NUMBERS**  
 7969XXXXX



# C&K Hardware

Miscellaneous Components, Hardware & Technical Data

## MISCELLANEOUS

<p><b>STOP PINS</b></p>  <p><b>PART NO.</b>  <b>402900000</b> 3 SERIES  <b>657800000</b> 3P SERIES  <b>537100000</b> M SERIES  <b>587300000</b> SF/SR &amp; S2 SERIES</p>	<p><b>3 SERIES CONNECTOR</b></p>  <p><b>PART NO.</b>  <b>605A00000</b> PC Fits 0, 1, 4, 5 terminations only.  <b>605A02000</b> SOLDER LUG</p>	<p><b>3P SERIES CONNECTOR</b></p>  <p><b>PART NO.</b>  <b>630000000</b> Fits 0, 1 terminations only.</p>
<p><b>M SERIES WASHERS</b></p>  <p><b>PART NO.</b>  <b>586800000</b> RUBBER PANEL SEAL  <b>537202000</b> ADHESIVE MYLAR RETAINS STOP PINS</p>	<p><b>Z3 TERMINATION FEMALE CONNECTOR</b></p>  <p><b>PART NO.</b>  <b>530100000</b></p>	<p><b>KS SERIES LED SUPPORT</b></p>  <p><b>PART NO.</b>  <b>540300000</b></p>

# Mouser Electronics

Authorized Distributor

Click to View Pricing, Inventory, Delivery & Lifecycle Information:

## C&K Switches:

[801801000](#) [801803000](#) [780701201](#) [537100000](#) [709901201](#) [580700201](#) [175050700](#) [707200201](#) [780701215](#)  
[479603000](#) [476803000](#) [700303202](#) [700201201](#) [785103000](#) [798203000](#) [484603000](#) [586800000](#) [464900201](#)  
[465802000](#) [477100201](#) [540400201](#) [753700201](#) [459102000](#) [530100000](#) [894102000](#) [121000102](#) [778500201](#)  
[638100000](#) [638101000](#) [752701000](#) [472706201](#) [895101201](#) [896802000](#) [708901000](#) [896803000](#) [894103000](#)  
[472800202](#) [894101000](#) [538702000](#) [708905000](#) [708906000](#) [761103000](#) [776002231](#) [801805000](#) [801807000](#)  
[700302202](#) [121000101](#) [767B00201](#) [452602263](#) [706202000](#) [708903000](#) [585A01000](#) [707100201](#) [540400A56](#)  
[708907000](#)



Компания «Океан Электроники» предлагает заключение долгосрочных отношений при поставках импортных электронных компонентов на взаимовыгодных условиях!

Наши преимущества:

- Поставка оригинальных импортных электронных компонентов напрямую с производств Америки, Европы и Азии, а так же с крупнейших складов мира;
- Широкая линейка поставок активных и пассивных импортных электронных компонентов (более 30 млн. наименований);
- Поставка сложных, дефицитных, либо снятых с производства позиций;
- Оперативные сроки поставки под заказ (от 5 рабочих дней);
- Экспресс доставка в любую точку России;
- Помощь Конструкторского Отдела и консультации квалифицированных инженеров;
- Техническая поддержка проекта, помощь в подборе аналогов, поставка прототипов;
- Поставка электронных компонентов под контролем ВП;
- Система менеджмента качества сертифицирована по Международному стандарту ISO 9001;
- При необходимости вся продукция военного и аэрокосмического назначения проходит испытания и сертификацию в лаборатории (по согласованию с заказчиком);
- Поставка специализированных компонентов военного и аэрокосмического уровня качества (Xilinx, Altera, Analog Devices, Intersil, Interpoint, Microsemi, Actel, Aeroflex, Peregrine, VPT, Syfer, Eurofarad, Texas Instruments, MS Kennedy, Miteq, Cobham, E2V, MA-COM, Hittite, Mini-Circuits, General Dynamics и др.);

Компания «Океан Электроники» является официальным дистрибьютором и эксклюзивным представителем в России одного из крупнейших производителей разъемов военного и аэрокосмического назначения «JONHON», а так же официальным дистрибьютором и эксклюзивным представителем в России производителя высокотехнологичных и надежных решений для передачи СВЧ сигналов «FORSTAR».



## JONHON

«JONHON» (основан в 1970 г.)

Разъемы специального, военного и аэрокосмического назначения:

(Применяются в военной, авиационной, аэрокосмической, морской, железнодорожной, горно- и нефтедобывающей отраслях промышленности)

«FORSTAR» (основан в 1998 г.)

ВЧ соединители, коаксиальные кабели, кабельные сборки и микроволновые компоненты:

(Применяются в телекоммуникациях гражданского и специального назначения, в средствах связи, РЛС, а так же военной, авиационной и аэрокосмической отраслях промышленности).



Телефон: 8 (812) 309-75-97 (многоканальный)

Факс: 8 (812) 320-03-32

Электронная почта: [ocean@oceanchips.ru](mailto:ocean@oceanchips.ru)

Web: <http://oceanchips.ru/>

Адрес: 198099, г. Санкт-Петербург, ул. Калинина, д. 2, корп. 4, лит. А