

# General Specifications

## Electrical Capacity (Resistive Load)

**Logic Level:** 0.4VA maximum @ 48V AC/DC maximum  
(Applicable Range 0.1mA ~ 0.1A @ 20mV ~ 48V)  
Note: Find additional explanation of operating range in Supplement section.

## Other Ratings

**Contact Resistance:** 50 milliohms maximum  
**Insulation Resistance:** 1,000 megohms minimum @ 500V DC  
**Dielectric Strength:** 1,000V AC minimum between contacts for 1 minute minimum;  
1,500V AC minimum between contacts & case for 1 minute minimum  
**Mechanical Life:** 100,000 operations minimum for bat lever models  
50,000 operations minimum for locking lever models  
**Electrical Life:** 50,000 operations minimum  
**Contact Timing:** Nonshorting (break-before-make)  
**Angle of Throw:** 24°

## Materials & Finishes

**Toggle/Lever:** Brass with chrome plating  
**Bushing:** Brass with nickel plating  
**Support Bracket:** Straight PC: phosphor bronze with tin plating; right angle & vertical: brass with tin plating  
**Housing:** Polybutylene terephthalate (PBT) (UL94V-0)  
**Base:** 1- and 2-pole GFR polyamide (UL94V-0); 4-pole liquid crystal polymer (LCP) (UL94V-0)  
**Movable Contacts:** Phosphor bronze with gold plating  
**Stationary Contacts:** Brass with gold plating  
**Terminals:** Brass with gold plating

## Environmental Data

**Operating Temp Range:** -10°C through +70°C (+14°F through +158°F)  
**Humidity:** 90 ~ 95% humidity for 240 hours @ 40°C (104°F)  
**Vibration:** 10 ~ 55Hz with peak-to-peak amplitude of 1.5mm traversing the frequency range & returning in 1 minute; 3 right angled directions for 2 hours  
**Shock:** 50G (490m/s<sup>2</sup>) acceleration (tested in 6 right angled directions, with 5 shocks in each direction)

## PCB Processing

**Soldering:** Wave Soldering recommended. See Profile A in Supplement section.  
Manual Soldering: 1- & 2-pole: 3 seconds maximum @ 350°C maximum;  
4-pole: 4 seconds maximum @ 410°C maximum  
**Cleaning:** Hand clean locally using alcohol based solution.  
See Cleaning specifications in Supplement section.

## Standards & Certifications

**Flammability Standards:** UL94V-0 rated housing & base  
The D2 Series toggles have not been tested for UL recognition or CSA certification.  
These switches are designed for use in a low-current, logic level circuit.  
When used as intended in a logic level circuit, the results do not produce hazardous energy.

# Distinctive Characteristics

Base of heat resistant resin meets UL94V-0 flammability rating.

Maximized voltage capability of 48V allows use in medium source applications and increases operating life.

Award-winning STC contact mechanism with benefits unavailable in conventional mechanisms: smoother positive detent actuation, increased contact stability, and unparalleled reliability. (Additional STC details under Terms and Acronyms in the Supplement section.)

Round .031" (0.8mm) diameter PC terminals for easy PCB assembly.

Terminal spacing conforms to standard .100" (2.54mm) PC board grid spacing.

Molded-in terminals prevent entry of flux, solvents, and other contaminants.

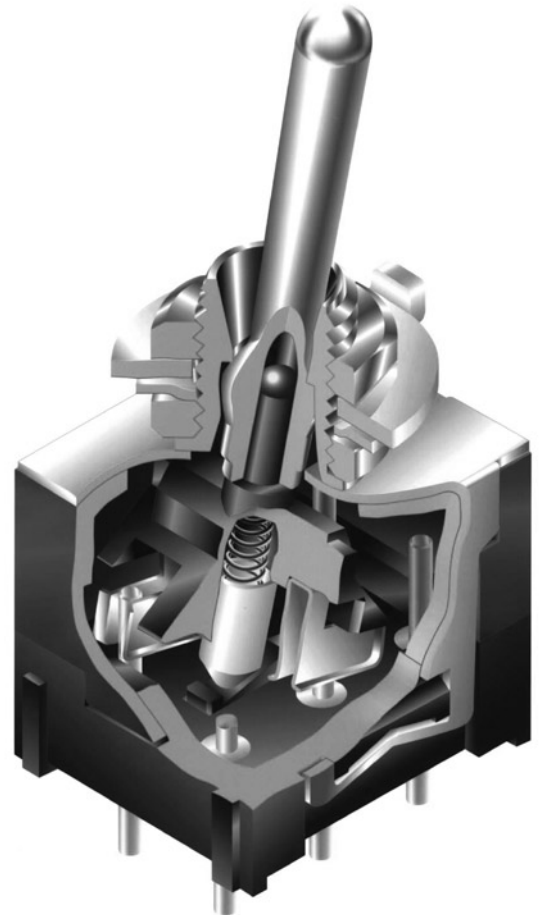

Actual Size

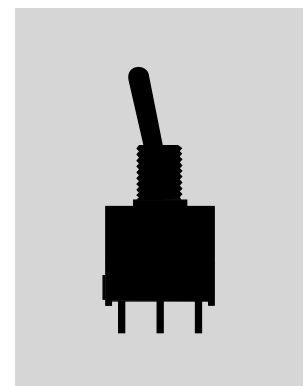
A  
Toggles

Rockers

Pushbuttons

Illuminated PB

Programmable

Keylocks

Rotaries

Slides

Tactiles

Tilt

Touch

Indicators

Accessories

Supplement

### TYPICAL SWITCH ORDERING EXAMPLE

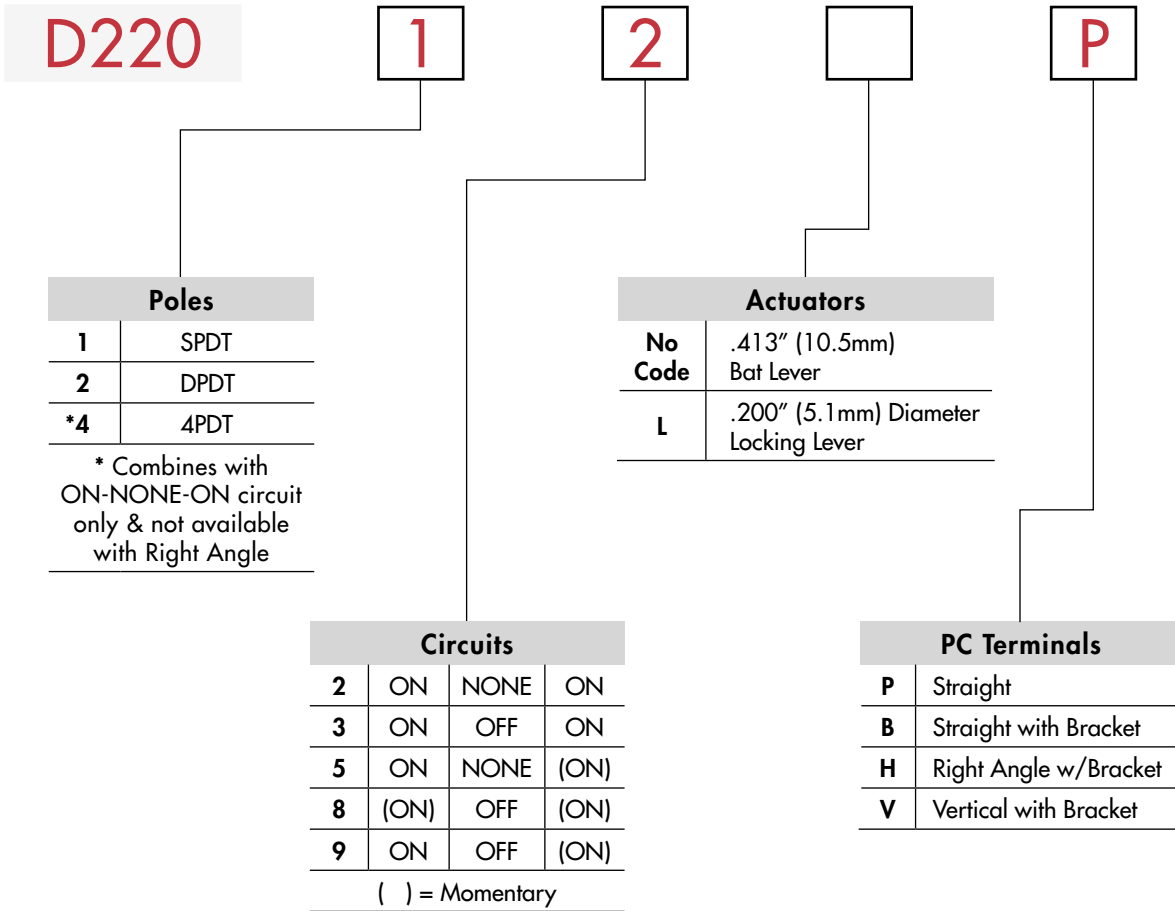

### DESCRIPTION FOR TYPICAL ORDERING EXAMPLE

#### D22012P



## POLES & CIRCUITS

Pole	Model	Toggle Position ( ) = Momentary			Connected Terminals			Throw & Schematics
		Down <small>Keyway</small>	Center	Up	Down <small>Keyway</small>	Center	Up	
SP	D22012 D22013 D22015 D22018 D22019	ON ON ON (ON) ON	NONE OFF NONE OFF OFF	ON ON (ON) (ON) (ON)	2-3	OPEN	2-1	Note: Terminal numbers are not actually on the switch. SPDT
DP	D22022 D22023 D22025 D22028 D22029	ON ON ON (ON) ON	NONE OFF NONE OFF OFF	ON ON (ON) (ON) (ON)	2-3 5-6	OPEN	2-1 5-4	DPDT
4P	D22042	ON	NONE	ON	2-3 5-6 8-9 11-12	OPEN	2-1 5-4 8-7 11-10	4PDT

## ACTUATORS

**No Code** .413" (10.5mm)  
Bat Lever

Material:  
Chrome over brass

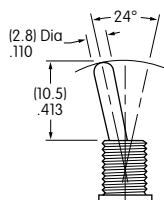

**L** .413" (5.1mm) Diameter  
Locking Lever

Material:  
Chrome over brass

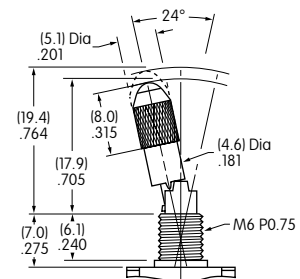

## PC TERMINALS

**P** Straight



**B** Straight with Bracket



**H** Right Angle with Bracket

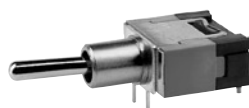

**V** Vertical with Bracket

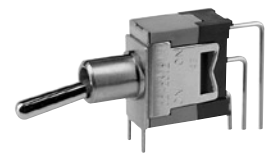

## OPTIONAL CAPS & CAP COLORS

**AT415**  
Bat Lever Cap

Material:  
Polyethylene

Colors Available:  
A B C E F G

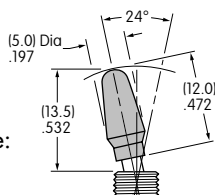

**AT444** Bat Lever  
Conical Cap

Material:  
Polyethylene

Colors Available:  
A B C E F G

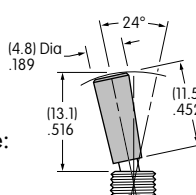

**AT427** Cap Supplied  
with Locking Lever

Material:  
Anodized  
Aluminum

Colors Available:  
A C G

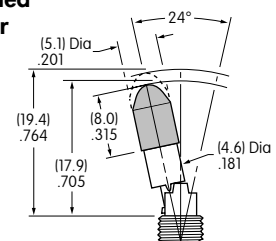

Colors Codes: A Black B White C Red E Yellow F Green G Blue

## TYPICAL SWITCH DIMENSIONS

### Straight PC • Single Pole



D22012P

D22012LP

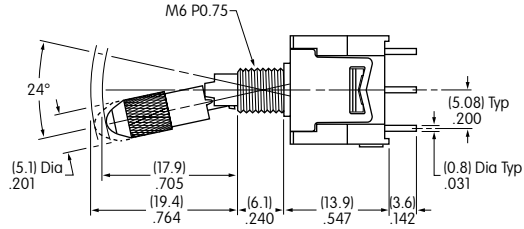

Actuator in Down Position

### Straight PC • Double Pole



D22022P

D22022LP

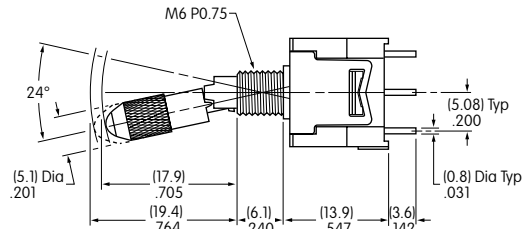
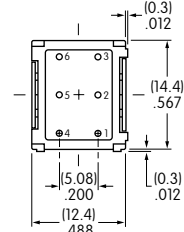
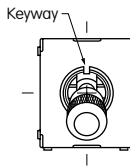
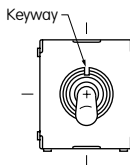

Actuator in Down Position

### Straight PC • Four Pole

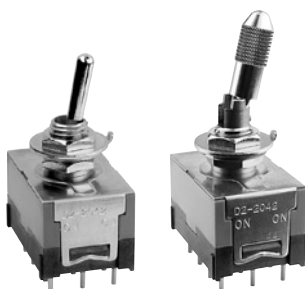

D22042P

D22042LP

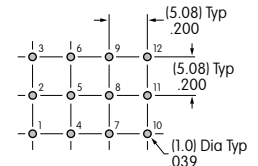
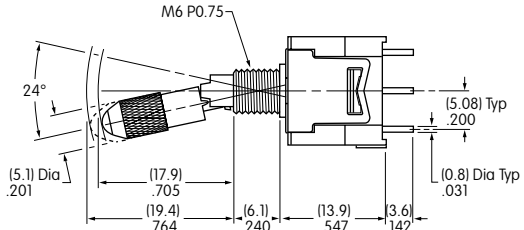
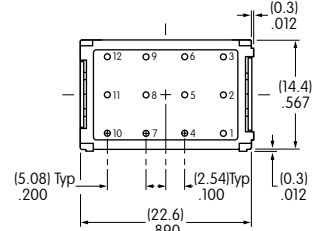
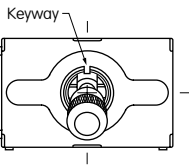
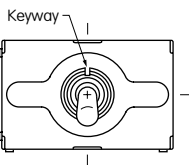

Actuator in Down Position

Rockers

Pushbuttons

Programmable Illuminated PB

Keylocks

Rotaries

Slides

Tactiles

Tilt

Touch

Indicators

Accessories

Supplement

TYPICAL SWITCH DIMENSIONS



Straight PC • Bracket Single Pole

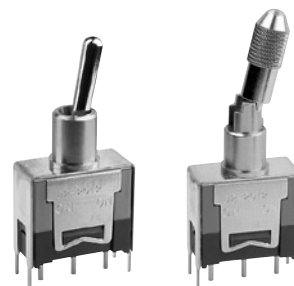

D22012B

D22012LB



Actuator in Down Position

Straight PC • Bracket Double Pole

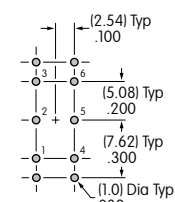
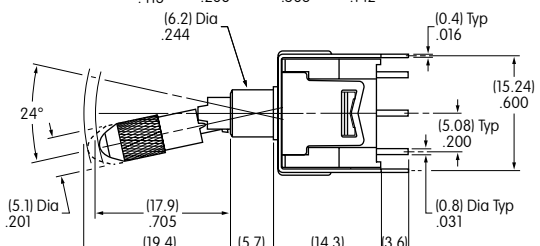
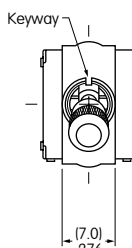
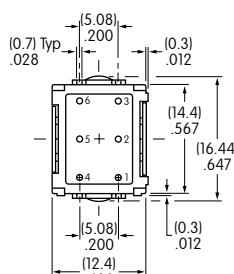

Actuator in Down Position

D22022B

D22022LB

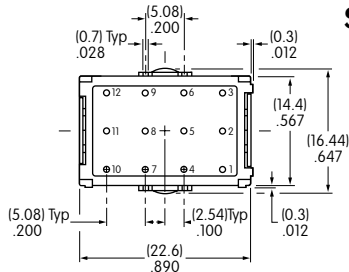
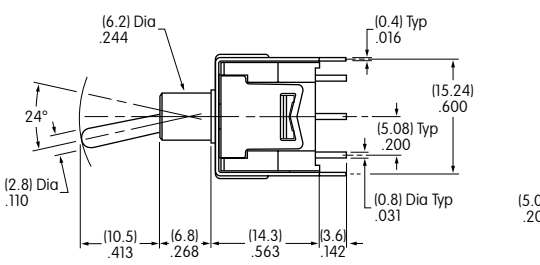
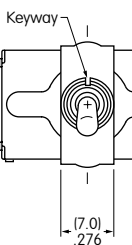

Straight PC • Bracket Four Pole

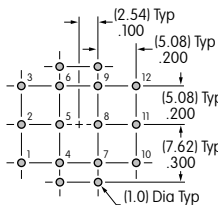
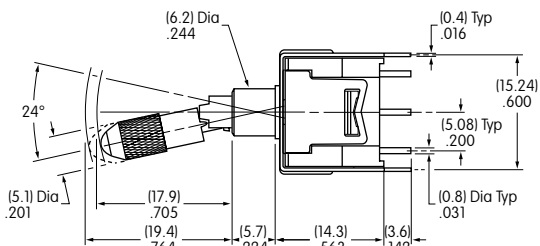
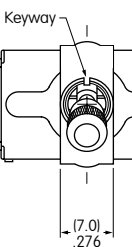

Actuator in Down Position

D22042B

D22042LB

**A** Toggles

Rockers

Pushbuttons

Programmable Illuminated PB

Keylocks

Rotaries

Slides

Tactiles

Tilt

Touch

Indicators

Accessories

Supplement

## TYPICAL SWITCH DIMENSIONS

### Right Angle PC • Single Pole



**D22012H**



**D22012LH**

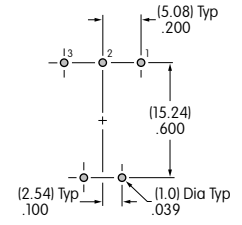

Actuator in Down Position

### Right Angle PC • Double Pole



**D22022H**

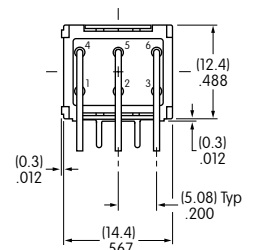
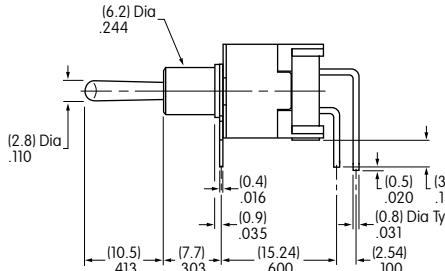
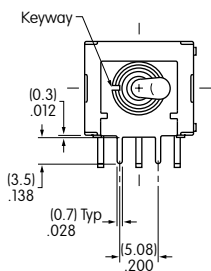

**D22022LH**

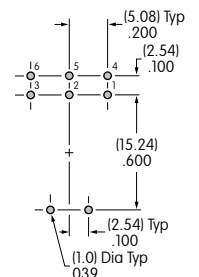
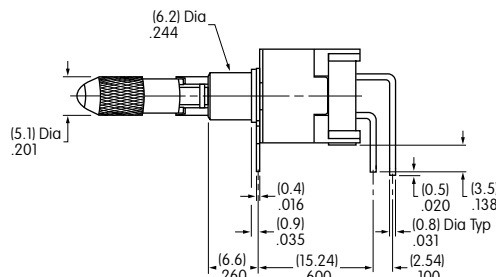

Actuator in Down Position

Rockers

Pushbuttons

Illuminated PB

Programmable

Keylocks

Rotaries

Slides

Tactiles

Tilt

Touch

Indicators

Accessories

Supplement

TYPICAL SWITCH DIMENSIONS

Vertical PC • Single Pole



D22012V



Actuator in Down Position

D22012LV

Vertical PC • Double Pole



D22022V



Actuator in Down Position

D22022LV

A Toggles

Rockers

Pushbuttons

Illuminated PB

Programmable

Keylocks

Rotaries

Slides

Tactiles

Tilt

Touch

Indicators

Accessories

Supplement



## TYPICAL SWITCH DIMENSIONS

### Vertical PC • Four Pole

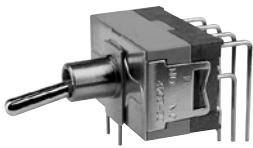

D22042V

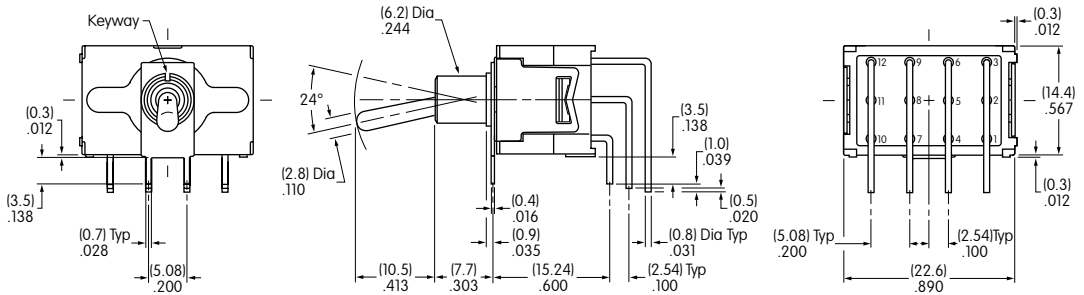

D22042LV

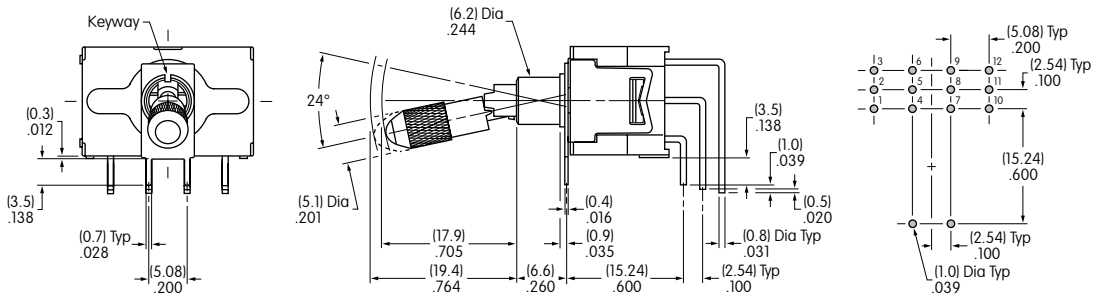

Actuator in Down Position

### STANDARD HARDWARE

**AT513M Hex Nut**  
Brass with nickel plating  
2 supplied

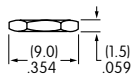
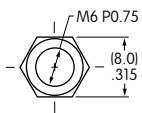

**AT507M Locking Ring**  
Steel with zinc/chromate  
1 supplied

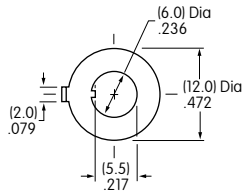

**AT509 Lockwasher**  
Steel with zinc/chromate  
1 supplied

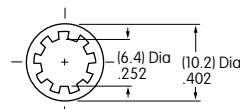

**AT501M Knurled Face Nut**  
Brass with chrome plating

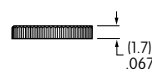
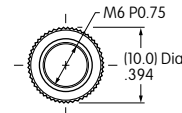

### OPTIONAL

### PANEL CUTOUTS & MAXIMUM PANEL THICKNESS

**With Standard Hardware**

.087" (2.2mm) for Standard Lever

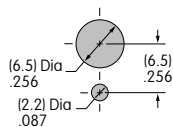

.051" (1.3mm) for Locking Lever

**Without Bottom Hex Nut**

.154" (3.9mm) for Standard Lever

.110" (2.8mm) for Locking Lever

**Without Locking Ring**

.118" (3.0mm) for Standard Lever

.083" (2.1mm) for Locking Lever

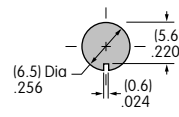

**Without Locking Ring & Bottom Hex Nut**

.185" (4.7mm) for Standard Lever

.142" (3.6mm) for Locking Lever



# Mouser Electronics

Authorized Distributor

Click to View Pricing, Inventory, Delivery & Lifecycle Information:

## [NKK Switches:](#)

[D22012B](#) [D22029B](#) [D22029H](#) [D22029LB](#) [D22029LH](#) [D22029LP](#) [D22029LV](#) [D22029V](#) [D22042B](#) [D22042LB](#)  
[D22042LP](#) [D22042LV](#) [D22042P](#) [D22042V](#) [D22012LP](#) [D22013B](#)

Компания «Океан Электроники» предлагает заключение долгосрочных отношений при поставках импортных электронных компонентов на взаимовыгодных условиях!

Наши преимущества:

- Поставка оригинальных импортных электронных компонентов напрямую с производств Америки, Европы и Азии, а так же с крупнейших складов мира;
- Широкая линейка поставок активных и пассивных импортных электронных компонентов (более 30 млн. наименований);
- Поставка сложных, дефицитных, либо снятых с производства позиций;
- Оперативные сроки поставки под заказ (от 5 рабочих дней);
- Экспресс доставка в любую точку России;
- Помощь Конструкторского Отдела и консультации квалифицированных инженеров;
- Техническая поддержка проекта, помощь в подборе аналогов, поставка прототипов;
- Поставка электронных компонентов под контролем ВП;
- Система менеджмента качества сертифицирована по Международному стандарту ISO 9001;
- При необходимости вся продукция военного и аэрокосмического назначения проходит испытания и сертификацию в лаборатории (по согласованию с заказчиком);
- Поставка специализированных компонентов военного и аэрокосмического уровня качества (Xilinx, Altera, Analog Devices, Intersil, Interpoint, Microsemi, Actel, Aeroflex, Peregrine, VPT, Syfer, Eurofarad, Texas Instruments, MS Kennedy, Miteq, Cobham, E2V, MA-COM, Hittite, Mini-Circuits, General Dynamics и др.);

Компания «Океан Электроники» является официальным дистрибьютором и эксклюзивным представителем в России одного из крупнейших производителей разъемов военного и аэрокосмического назначения «JONHON», а так же официальным дистрибьютором и эксклюзивным представителем в России производителя высокотехнологичных и надежных решений для передачи СВЧ сигналов «FORSTAR».



## JONHON

«JONHON» (основан в 1970 г.)

Разъемы специального, военного и аэрокосмического назначения:

(Применяются в военной, авиационной, аэрокосмической, морской, железнодорожной, горно- и нефтедобывающей отраслях промышленности)

«FORSTAR» (основан в 1998 г.)

ВЧ соединители, коаксиальные кабели, кабельные сборки и микроволновые компоненты:

(Применяются в телекоммуникациях гражданского и специального назначения, в средствах связи, РЛС, а так же военной, авиационной и аэрокосмической отраслях промышленности).



Телефон: 8 (812) 309-75-97 (многоканальный)

Факс: 8 (812) 320-03-32

Электронная почта: [ocean@oceanchips.ru](mailto:ocean@oceanchips.ru)

Web: <http://oceanchips.ru/>

Адрес: 198099, г. Санкт-Петербург, ул. Калинина, д. 2, корп. 4, лит. А