



Corcom Product Guide



RFI Power Line Filters

TE Connectivity (TE) offers over 300 solutions for RFI problems associated with susceptibility, as well as compliance with international emissions standards.



IEC Inlet Filters and Power Entry Modules

A complete line of power entry modules solves a variety of power entry needs by combining functions to reduce cost, space and labor.



DC Filters

TE has developed a wide range of power line filters and power entry modules that combine several power management functions specifically designed for DC applications.



Feedthrough Filters and Capacitors

Designed to offer reliability and performance in high frequency applications and meet EN132200 and 132400 safety requirements. Available for AC or DC applications.



Signal Line Products

The SignalSentry filtered modular jack connector series combines different levels of filtering with RJ45 and RJ11 modular jacks to address signal line noise problems and crosstalk.

TE Connectivity Corcom Products Engineering Offices

USA

620 S. Butterfield Road
Mundelein, IL 60060
Phone: 847-680-7400
Fax: 847-680-8169

6700 Fallbrook Ave.
Suite 287
West Hills, CA 91307
Phone: 818-226-4306
Fax: 818-704-1757

Germany

Finsinger Feld 1
D-85521 Ottobrunn,
Phone: 49-89-6089-0
Fax: 49-89-6089-767

People's Republic of China

668 Guiping Road
Shanghai, 200233
Phone: 86-21-2407-1588
Fax: 86-21-2407-1599

For Sales assistance in the USA please refer to page 286 to find a Corcom product sales representative in your area. For Sales assistance in all other regions, please refer to page 289 to find the Product Information Center in your area.

Main Table of Contents

Navigating the Catalog	3
1. RFI Power Line Filters	9
RFI Power Line Filter Selector Chart	11
AQ Series	12
B Series	15
DK Series	18
EBP Series	21
EDP Series	21
EOP Series	21
EMC Series	24
EP & VP Series	27
FC Series	30
FL Series	33
G Series	35
HQ Series	37
HT Series	40
HZ Series NEW 4, 6, 10 and 20A versions	43
IK Series	46
K Series	49
MV Series	54
N Series	56
Q Series	58
R Series	61
RK Series	65
S Series	68
SB Series NEW High Performance B Series	71
SK Series	75
T Series	80
U Series	84
V Series	86
W Series	86
WG Series	89
X Series	92
Y Series	92
Z Series	92
2. Three Phase Filters	97
Three Phase Selector Chart	97
A Series	98
ADT Series	101
AYA Series	104
AYC Series	108
AYO Series	111
BCF Series NEW Compact Three Phase Filters	113
CFN Series	116
FCD Series	118
3. Power Inlet Filters & Power Entry Modules	125
Introduction	126
Selector Chart	128
Power Entry Module Selector Guide	129
C Series	130
CU Series NEW Compact 1U Height Power Entry Module	134
EBF Series	138
EC Series	141
ED Series	144
EEA & EEB Series	148
EAS & EBS Models	148
EAH & EBH Models	148
EEJ Series	153

Table of Contents *(continued)*

EJH & EJHS Models	153
EJM & EJMS Models	153
EJS Models	153
EF Series	160
EJT Series	163
GG & HG Series	166
H Series	169
J Series	172
L Series	175
LA Series	180
M Series	183
P Series	192
SR Series	201
SRB Series	203
4. DC Filters	209
Introduction	210
Selector Chart	211
DA Series	212
DB Series NEW - Compact RFI High Current DC Inlet	214
DC Series	217
P Series	223
5. Feedthrough Filters and Capacitors	225
Feedthrough Application Selector Chart	225
Introduction	226
FFA Series	228
FFD Series	231
AFC Series	234
DFC Series	237
6. Signal Line Products	241
Introduction	242
SignalSentry Filtered Modular Jacks	243
SignalSentry Part Number Matrix / Ordering Information	244
SignalSentry Selector Chart	245
L Series	247
L - Ganged Series	248
LC Series	249
LCT Series	250
N Series	251
X Series	252
Z Series	253
Model Dimensions	255
L, LC, LCT and X Series RJ Jack Dimensions	255
N and Z Series RJ Jack Dimensions	257
7. Technical Notes	261
Introduction	262
Understanding RFI Power Line Filters	263
Understanding Hipot Testing	266
Understanding Leakage Current (Touch Current)	267
Understanding Insertion Loss	268
Appendix A - Conducted RFI Emissions Testing	269
Appendix B - Conducted RFI Susceptibility Testing	270
Appendix C - Health Care Equipment	270
Appendix D - Safety Agency File Numbers	271
Part Number Index and Cross Reference	273
North American Sales Representatives	286
Authorized Corcom Product Distributors	288
Worldwide Contacts	Inside Back Cover

Navigating the Catalog

Step 1: Determine the product family.

The Corcom product guide contains seven sections with six distinct product families. Use the index numbers along the side of the catalog to quickly jump to that section.

Corcom Product Families

RFI Power Line Filters

Solutions associated with EMI/RFI susceptibility as well as compliance to international emissions standards for single phase power applications. Includes chassis and board mountable designs as well as single and two-stage filters.

Three Phase Filters

Solutions associated with EMI/RFI susceptibility as well as compliance to international emissions standards for three phase and high current applications.

IEC Inlet and Power Entry Modules

IEC inlet power filters and modular products that address a variety of power entry needs by combining several functions such as on/off switching, voltage selection switching, fuseholder, filtering in combination with the IEC inlet connector.

DC Power Line Filters

EMI/RFI solutions for emissions and susceptibility specifically related to DC systems often found in central office and telecommunication applications.

Feedthrough Filters and Capacitors

Products designed for through-bulkhead mounting for high frequency filtering. Designed to meet EN133200 and EN132400 safety requirements. Available in a variety of standard as well as custom configurations.

Signal Line Products

Products that combine different levels of filtering with various sized RJ modular jacks. Signal line products are used to protect data transmissions as they pass through the RJ jacks or as they are transmitted on the PCB.

Technical Notes

The appendices in the back of the catalog offer information such as safety agency classifications, general information regarding RFI, and testing procedures.

(continued on next page)

Looking for Corcom EMI Facility Products?

Power, data and signal line filters for shielded installations
Available in Catalog 1654986 - see page 8 for more information

Navigating the Catalog *(continued)*

Step 2: Use selector charts

Selector charts at the beginning of each section help you to narrow the selection.

Follow the chart to locate one or several product series that could fit your specific application and requirements.

Optimal filter selection requires testing in your specific system, as all systems have unique characteristics.

Selector charts generally show filters in order of performance from good (at the top) to best performance (at the bottom).



Step 3: Open to the page referenced by the selector chart

Each product series contains three technical sections. The majority of questions relating to product applications can be answered directly from these sections.

Technical Characteristics: This first section contains pictures, appropriate safety agency classifications, a description of the series’ capabilities, applications, electrical specifications, schematics, ordering information and available part numbers.

Drawings: The second section contains drawings and dimensions of the parts as well as the recommended cutouts. Dimensions are shown in inches with metric equivalents.

Performance Data: The third section contains performance data in the form of typical insertion loss graphs and minimum insertion loss tables.

If you already know the catalog number or series, the table of contents lists each series in the catalog within each section. The back of the catalog also has an index in alphanumeric order. The index will reference the technical section for that catalog number or series. The index also provides the unique TE ordering number for each part.

Step 4: Contact your local Corcom product sales representative

Corcom product sales representatives for North America as well as distributors and global contacts are listed in the back of the catalog. Contact the sales representative or office closest to you for technical assistance, stock and pricing.

Corcom EMI/RFI Filters and Energy Efficiency



The efficiency of an electrical device is the ratio of the power it delivers to the power that it consumes. The difference is wasted as heat, and to prevent overheating of a device and the system in which it resides, this heat must be transferred out of the system and dissipated. The efficiency of every component, including the power entry module and selected filter, factors into the system's overall efficiency. When the amount of heat is too great to dissipate through the system's enclosure, forced air cooling becomes necessary. This is often accomplished with a fan, and the power used by that fan, (including its own thermal losses) further decreases the system efficiency by another 2% to 5%. Providing room for the fan and air passageways in the equipment increases its size and cost. Careful attention to the efficiency of every component in the system results in a simpler, smaller, lighter, cooler, more competitive product.

Corcom EMI filters can help meet energy efficiency goals, including Energy Star rating and the new 80 Plus certification, which now recognizes systems that exceed 90% efficiency. By using the most energy efficient design and materials, Corcom filters can be the beginning of an energy efficient system strategy.

Energy efficient power components don't just lower energy bills and demand for power from the grid, they also increase product reliability. Small efficiency increases can decrease component temperatures throughout the system, and semiconductor life doubles for every 10°C decrease in temperature. Corcom filters are more efficient and run cooler, and this can help reduce system warranty costs, service calls and total support costs.

Corcom filters

- Have heat dissipation ratings as little as one third that of comparable filters.
- Create less heat and run cooler
- Improve system reliability
- Are more efficient than PC board equivalents
- Can help meet system power efficiency standards
- Enable systems to be smaller and lighter
- Save customers money by reducing energy costs



Corcom Products Engineering Services and Custom Solutions

Corcom Products Engineering Services and Custom Solutions



TE Connectivity Corcom products were established as the world leader in EMI/RFI filtering technology with the introduction of the first line of catalog filter products over 50 years ago.

Today, TE continues to pursue the latest in EMI/RFI filter design by testing and evaluating application specific solutions for a wide range of industries.

In addition to our complete catalog of standard EMI/RFI filtering solutions, TE offers a full range of engineering services and custom products designed for unique applications.

Corcom custom EMI/RFI product solutions can:

- Optimize both cost and performance to target a unique application
- Fit unique mechanical size, installation and/or connection requirements
- Ensure conformance with EMI/RFI requirements of an entire system
- Apply EMI/RFI filtering in a specific frequency or range

With design and testing facilities worldwide, TE is well suited to design an EMI/RFI solution that meets a wide range of unique application needs.

To discuss application specific filtering, contact the TE Corcom product sales representative or office closest to you. A complete list of sales representative and worldwide contacts is listed in the back of this catalog.

Corcom Custom Filters Key Features:

- Custom filter options
- Custom wire harness design
- Fully customizable options including packaging
- Agency approvals available as needed by customer
- Time and cost savings to customer
- Simplify installation

Termination and Wiring Customization Options:

- Wire length
- Wire gauge
- Wire color
- Molded connectors
- Ring terminals
- Custom terminations

Corcom Engineering Services and Custom Solutions

EMI/RFI Testing Services

Corcom Products Test Lab Key Features:

- We can test product to the FCC / EN / EFT specifications
- Let us know your testing needs and time frame to ensure flexibility of testing and timely results

Available Testing Standards:

- Conducted EMI in accordance with FCC part 15 and 18
- EN55011, EN55022 and EN55014
- EFT (Electrically Fast Transient) in accordance with EN61000-4-4
- Tests conducted up to 30A with insertion loss measured up to 10GHZ
- MIL-STD-461 CE101 & CE102

An increase in electronic content and stringent regulatory compliance requirements have increased the need for time spent in qualifying test houses. At these “test labs,” products undergo a number of qualifying tests which include conducted emissions, EFT, and harmonic content. Failure to comply with associated standards can lead to delayed time-to-market and product redesign resulting in lost revenue and market share and an increase in time spent at the test lab.

TE Connectivity can help by heading off some of the potential pitfalls during testing and qualifying phases of new products. We offer complimentary testing to existing regulatory standards. We aim for a high standard of accuracy, and can help identify potential problems.

We are not a certifying body and our test lab is not a qualified test lab; however, we test to the same standards and take product through the same rigor as any certifying lab. In addition, our engineers will recommend a solution and help with a design should a product fail to comply with conducted emissions, EFT and/or harmonic content standards.

The advantage is clear: TE will provide you with a high degree of confidence that a product which passed our in-house testing will pass agency testing at a certifying test house in reduced time and with reduced cost.

TE has three Corcom filter testing facilities:

- Mundelein, IL, USA (main office and design center)
- West Hills, CA, USA (regional office)
- Ottobrunn, Germany (regional office and design center)



Corcom EMI / RFI Product Solutions for Facility and Heavy Power

Corcom EMI Facility Products

Power, data and signal line filters for shielded installations

TE Connectivity has dedicated more than 50 years to developing RFI filter technology for electronic devices. We're proud that our focus on the design and production of the highest quality products has made TE a world leader in RFI technology.

Our leadership in the filter and power entry module markets was enhanced in 1988 with the acquisition of the Heavy Power Line Division of Cornell Dubilier. The high quality designs and manufacturing of these heavy power line filter products is maintained and enhanced by TE.

We have continued that dedication to excellence begun by Cornell Dubilier and inherent to TE's way of doing business. Only the highest quality designs, capacitors, inductors, and workmanship are used to produce these filters. We recognize the need for great care demanded by hi-rel military filters and automatically apply like quality to the heavy power line products. We treat all product as if it is high-reliability.

The Mundelein, IL office provides application engineering service for these heavy power line and military products. Our engineers can help to design a special filter in the rare case a standard product from this catalog cannot adequately solve the problem. Additional product performance data and test results are available from the engineers at this facility.

TE's worldwide sales offices can help you locate information on these products or any of the hundreds of high quality power line filters, power entry modules and SignalSentry products made by TE.

For more information on the complete line of EMI Facility products, request catalog number 1654986 or visit www.corcom.com



1. RFI Power Line Filters – Table of Contents

RFI Power Line Filter Selector Chart11

AQ Series12

B Series15

DK Series18

EBP Series21

EDP Series21

EOP Series21

EMC Series24

EP & VP Series27

FC Series30

FL Series33

G Series35

HQ Series37

HT Series40

HZ Series43

IK Series46

K Series49

MV Series54

N Series56

Q Series58

R Series61

RK Series65

S Series68

SB Series71

SK Series75

T Series80

U Series84

V Series86

W Series86

WG Series89

X Series92

Y Series92

Z Series92



Engineering Notes



RFI Power Line Filter Selector Chart



All Series Are Listed in Ascending Performance

from

Good

to

↓

Better

to

↓

Best

High Frequency Power Line Filter or Power Entry Module

AQ Series



UL Recognized
CSA Certified



AQ Series

- Low cost solution to power line noise at high frequencies
- High common and differential mode performance from 10kHz to 1GHz
- Available with an IEC inlet, fuseholder and switch
- Suitable for applications where computers are used to process secret or confidential information

Ordering Information



Available Part Numbers

3VAQ3	6VAQ3
3VAQ8F	6VAQ8F
3VAQ8FS	6VAQ8FS

*IEC 60320-1 C14 inlet mates with C13 connector

Specifications

Maximum leakage current each Line to Ground:

	3A Models	6A Models
@ 120 VAC 60 Hz:	1.2 mA	.7 mA
@ 250 VAC 50 Hz:	2.3 mA	1.2 mA

Hipot rating (one minute):

Line to Ground:	2250 VDC
Line to Line:	1450 VDC

Rated Voltage (max):

250 VAC

Operating Frequency:

50/60 Hz

Rated Current:

3 or 6A

Operating Ambient Temperature Range

(at rated current I_r): -10°C to +40°C
In an ambient temperature (T_a) higher than +40°C the maximum operating current (I_o) is calculated as follows: $I_o = I_r \sqrt{(85-T_a)/45}$

Electrical Schematics

3A Models



6A Models



Accessories

GA400: NEMA 5-15P to IEC 60320-1 C-13 line cord



High Frequency Power Line Filter or Power Entry Module *(continued)*

AQ Series

Case Styles and Dimensions

3VAQ3



6VAQ3



3VAQ8F



6VAQ8F



3VAQ8FS



6VAQ8FS



High Frequency Power Line Filter or Power Entry Module *(continued)*

AQ Series

Recommended Panel Cutouts



Performance Data

Typical Insertion Loss

Measured in closed 50 Ohm system

3VAQ



6VAQ



— Common Mode / Asymmetrical (L-G)
- - - Differential Mode / Symmetrical (L-L)

Minimum Insertion Loss

Measured in closed 50 Ohm system

Common Mode / Asymmetrical (Line to Ground)

Current Rating	Frequency – MHz								
	.01	.1	.5	1	10	50	100	300	1000
3A	10	80	88	88	100	100	100	93	85
6A	26	59	80	80	100	100	100	93	85

Differential Mode / Symmetrical (Line to Line)

Current Rating	Frequency – MHz								
	.01	.1	.5	1	10	50	100	300	1000
3A	6	51	78	88	100	100	100	93	85
6A	10	65	86	95	100	100	100	93	85

General Purpose RFI Filters for High Impedance Loads at Low Current

B Series



UL Recognized
CSA Certified
VDE Approved



B Series

- Small size & low cost
- General purpose
- Wide variety of termination options
- Meets low leakage current requirements of VDE portable equipment and non-patient medical equipment

Ordering Information



Electrical Schematic



Specifications

Maximum leakage current each Line to Ground:

	VB Models	EB Models
@ 120 VAC 60 Hz:	.4 mA	.21 mA
@ 250 VAC 50 Hz:	.7 mA	.36 mA

Hipot rating (one minute):

Line to Ground:	2250 VDC
Line to Line:	1450 VDC

Rated Voltage (max): 250 VAC

Operating Frequency: 50/60 Hz

Rated Current: 1 to 30A

Operating Ambient Temperature Range

(at rated current I_r): -10°C to +40°C
In an ambient temperature (T_a) higher than +40°C the maximum operating current (I_o) is calculated as follows: $I_o = I_r \sqrt{(85-T_a)/45}$

Available Part Numbers

1VB1	1EB1
1VB3	1EB3
2VB1	2EB1
2VB3	2EB3
3VB1	3EB1
3VB3	3EB3
5VB1	5EB1
5VB3	5EB3
10VB1	10EB1
10VB3	10EB3
10VB6	20EB1
20VB1	
20VB6	
30VB6	

General Purpose RFI Filters for High Impedance/ Low Current *(continued)*

B Series

Case Styles

B1



Typical Dimensions:
 Line/Load Terminals (4): .250 [6.3] with .07 [1.8] Dia. hole
 Ground Terminal (1): .250 [6.3] with .07 x .16 [1.8 x 3.8] slot
 Mounting Holes (2): .188 [4.75] Dia.

30VB6



Typical Dimensions:
 Terminals (5): 8-32, Torque 18 lbf-in. [2.03 N-m] max. ± 2 [2.2]
 Mounting Slots (4): .250 x .156 [6.35 x 3.96]

B3



Typical Dimensions:
 Wire leads (5): 4.0 [101.6] Min. AWG18, (AWG16 for 10A)
 Mounting Holes (2): .188 [4.75] Dia.

10VB6 & 20VB6



Typical Dimensions:
 Terminals (5): 8-32, Torque 18 lbf-in. [2.03 N-m] max. ± 2 [2.2]
 Mounting Holes (4): .188 [4.75] Dia.

Case Dimensions

Part No.	A (max)	B (max)	C (max)	D $\pm .015$ $\pm .38$	E (max)
1VB1, 1EB1,	2.25	1.82	0.66	2.125	2.53
2VB1, 2EB1	57.2	46.2	16.8	53.98	64.3
1VB3, 1EB3,	0.96	1.82	0.66	2.125	2.53
2VB3, 2EB3	24.4	46.2	16.8	53.98	64.3
3VB1, 3EB1,	2.61	1.82	0.78	2.125	2.53
5VB1, 5EB1	66.3	46.2	193.8	53.98	64.3
3VB3, 3EB3,	1.32	1.82	0.78	2.125	2.53
5VB3, 5EB3	33.5	46.2	19.8	53.98	64.3
10VB1, 10EB1	2.61	1.82	1.16	2.125	2.53
	66.3	46.2	29.5	53.98	6.3
10VB3, 10EB3	1.32	1.82	1.16	2.125	2.53
	33.5	46.2	29.5	53.98	64.3
10VB6	2.72	1.82	1.16	2.125	2.53
	69.1	46.2	29.5	53.98	64.3
20VB1, 20EB1	3.36	2.07	1.16	2.375	2.81
	85.3	52.6	29.5	60.33	71.4
20VB6	3.46	2.07	1.16	2.375	2.81
	87.9	52.6	29.5	60.33	71.4
30VB6	5.34	3.38	1.53	3.75	4.20
	135.6	85.9	38.9	95.3	106.7

General Purpose RFI Filters for High Impedance/ Low Current *(continued)*

B Series

Performance Data

Typical Insertion Loss

Measured in closed 50 Ohm system

— Common Mode / Asymmetrical (L-G)
— Differential Mode / Symmetrical (L-L)

1EB & 3EB



2EB, 5EB & 10EB



20EB



1VB



2VB



3VB



10VB



20VB



30VB



Minimum Insertion Loss

Measured in closed 50 Ohm system

Common Mode / Asymmetrical (Line to Ground)

Current Rating	Frequency – MHz					
	.15	.5	1	5	10	30
VB Models						
1A, 3A	15	30	38	50	50	50
2A, 5A, 10A, 20A, 30A	7	20	25	40	45	48
EB Models						
1A, 3A	15	29	35	45	45	48
2A, 5A, 10A, 20A	7	19	23	34	37	42

Enhanced Differential Mode Performance K Series RFI Line Filters

DK Series



UL Recognized
CSA Certified
VDE Approved



DK Series

- Higher performance Line to Line attenuation than the K Series
- E version meets the low leakage current requirements of VDE portable equipment and non-patient care equipment
- V version features same high performance with more cost-effective design

Ordering Information

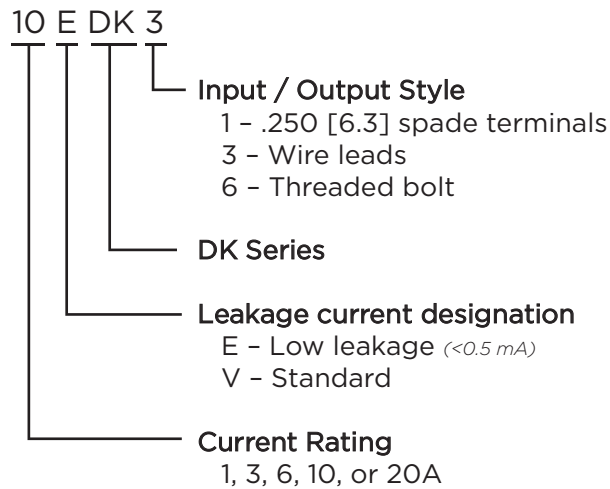

Electrical Schematic

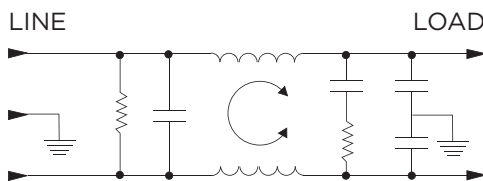

Specifications

Maximum leakage current each Line to Ground:

	VDK Models	EDK Models
@ 120 VAC 60 Hz:	.4 mA	.22 mA
@ 250 VAC 50 Hz:	.7 mA	.38 mA

Hipot rating (one minute):

Line to Ground:	2250 VDC
Line to Line:	1450 VDC

Rated Voltage (max): 250 VAC

Operating Frequency: 50/60 Hz

Rated Current: 1 to 20A

Operating Ambient Temperature Range

(at rated current I_r): -10°C to +40°C
In an ambient temperature (T_a) higher than +40°C the maximum operating current (I_o) is calculated as follows: $I_o = I_r \sqrt{(85-T_a)/45}$

Available Part Numbers

1VVK1	1EDK1
1VVK3	1EDK3
3VVK1	3EDK1
3VVK3	3EDK3
6VVK1	6EDK1
6VVK3	6EDK3
10VVK1	10EDK1
10VVK3	10EDK3
20VVK1	20EDK1
20VVK6	

Enhanced Differential Mode K Series RFI Power Line Filters *(continued)*

DK Series

Case Styles

VDK1 / EDK1



Typical Dimensions:
 Line/Load Terminals (4): .250 [6.3] with .07 [1.8] Dia. hole
 Ground Terminal (1): .250 [6.3] with .07 x .16 [1.8 x 3.8] slot
 Mounting Holes (2): .188 [4.75] Dia.

VDK3 / EDK3

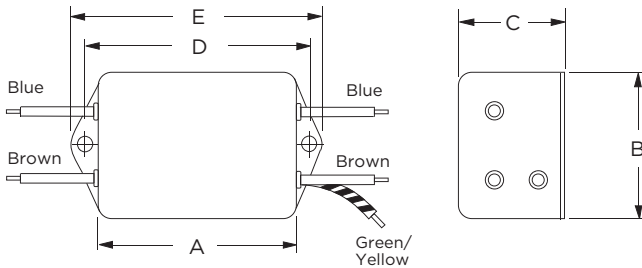

Typical Dimensions:
 Wire leads (5): 4.0 [101.6] Min., AWG18 (AWG16 for 10A)
 Mounting Holes (2): .188 [4.75] Dia.

20VVDK1 / 20EDK1

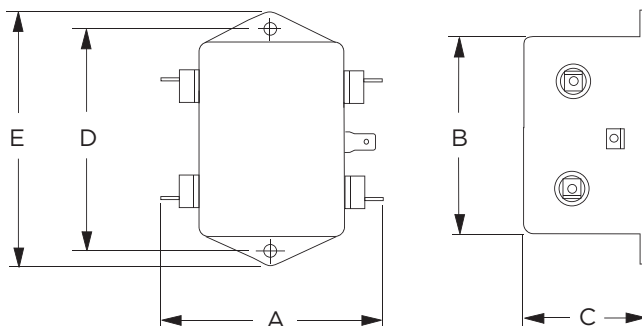

Typical Dimensions:
 Line/Load Terminals (4): .250 [6.3] with .07 [1.8] Dia. hole
 Ground Terminal (1): .250 [6.3] with .07 x .16 [1.8 x 3.8] slot
 Mounting Holes (4): .188 [4.75] Dia.

20VVDK6



Typical Dimensions:
 Terminals (5): 8-32, Torque 18 lbf-in. [2.03 N-m] max. ± 2 [22]
 Mounting Holes (2): .188 [4.75] Dia.

Case Dimensions

Part No.	A (max)	B (max)	C (max)	D $\pm .015$ $\pm .38$	E (max)
1VVDK1, 1EDK1	3.35 85.1	2.07 52.6	1.16 29.5	2.375 60.33	2.81 71.4
1VVDK3, 1EDK3	2.07 52.6	2.07 52.6	1.16 29.5	2.375 60.33	2.81 71.4
3VVDK1, 3EDK1, 6VVDK1, 6EDK1	3.85 97.8	2.07 52.6	1.16 29.5	2.938 74.63	3.35 85.1
3VVDK3, 3EDK3, 6VVDK3, 6EDK3	2.56 65.0	2.07 52.6	1.16 29.5	2.938 74.63	3.35 85.1
10VVDK1, 10EDK1	3.85 97.8	2.07 52.6	1.32 33.5	2.938 74.63	3.35 85.1
10VVDK3, 10EDK3	2.57 65.3	2.07 52.6	1.32 33.5	2.938 74.63	3.35 85.1
20VVDK1, 20EDK1	3.85 97.8	2.58 65.5	1.78 45.2	2.938 74.63	3.35 85.1
20VVDK6	3.46 87.9	2.58 65.5	1.78 45.2	2.938 74.63	3.35 85.1

Enhanced Differential Mode K Series RFI Power Line Filters *(continued)*

DK Series

Performance Data

Typical Insertion Loss

Measured in closed 50 Ohm system

1 & 3VDK



6, 10, 20VDK



1 & 3EDK



6, 10, 20EDK



— Common Mode / Asymmetrical (L-G)
— Differential Mode / Symmetrical (L-L)

Minimum Insertion Loss

Measured in closed 50 Ohm system

Common Mode / Asymmetrical (Line to Ground)

Current Rating	Frequency – MHz					
	.15	.5	1	5	10	30
VDK Models						
1A, 3A	18	30	40	48	48	40
6A, 10A, 20A	10	22	30	39	44	50
EDK Models						
1A, 3A	17	27	33	45	45	40
6A, 10A, 20A	10	19	25	34	40	46

Differential Mode / Symmetrical (Line to Line)

Current Rating	Frequency – MHz					
	.15	.5	1	5	10	30
VDK & EDK Models						
1A, 3A	18	47	62	60	50	45
6A, 10A, 20A	20	43	55	65	60	55

PC Board Mountable General Purpose RFI Filters

EBP, EDP & EOP Series



UL Recognized*
CSA Certified*
VDE Approved*



EBP Series

- General purpose
- Low leakage current
- Cost-effective
- Compact size

EDP Series

- Enhanced differential mode performance
- Low leakage current
- Cost-effective

EOP Series

- General purpose
- Low leakage current
- Cost-effective

Ordering Information

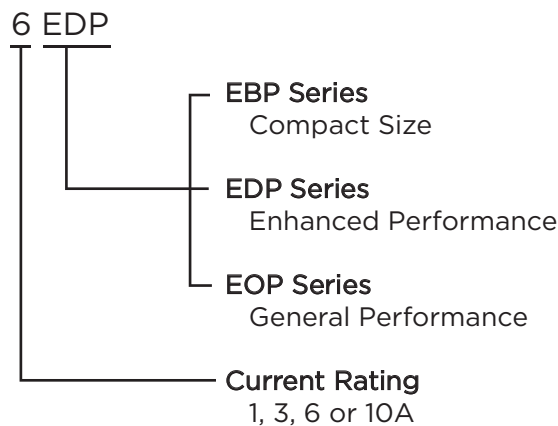

*EBP models are approved to VDE standards only

Specifications

Maximum leakage current each Line to Ground:

	EDP/EOP	EBP
@ 120 VAC 60 Hz:	.22 mA	.13 mA
@ 250 VAC 50 Hz:	.38 mA	.21 mA

Hipot rating (one minute):

Line to Ground:	2250 VDC
Line to Line:	1450 VDC

Rated Voltage (max):

250 VAC

Operating Frequency:

50/60 Hz

Rated Current:

1 to 10A

Operating Ambient Temperature Range

(at rated current I_r): -10°C to +40°C
In an ambient temperature (T_a) higher than +40°C the maximum operating current (I_o) is calculated as follows: $I_o = I_r \sqrt{(85-T_a)/45}$

Electrical Schematic

EBP



EDP & EOP



Available Part Numbers

1EBP	3EBP
1EDP	1EOP
3EDP	3EOP
6EDP	6EOP
10EDP	10EOP

PC Board Mountable General Purpose RFI Filters (continued)

EBP, EDP, EOP Series

Case Styles

EBP



Typical Dimensions:
Pins (5): 0.025 [0.635] square

EDP / EOP



Typical Dimensions:
Pins (5): 0.025 [0.635] square

Case Dimensions

Part No.	A (max)	B (max)	C (max)
EBP	.984 25.0	.984 25.0	.984 25.0
EDP	1.44 36.6	1.24 31.5	0.95 24.15
EOP	1.44 36.6	1.24 31.5	0.78 19.9

Performance Data

Typical Insertion Loss

Measured in closed 50 Ohm system

1EBP



3EBP



— Common Mode / Asymmetrical (L-G)
- - - Differential Mode / Symmetrical (L-L)

PC Board Mountable General Purpose RFI Filters (continued)

EBP, EDP & EOP Series

Performance Data (continued)

Typical Insertion Loss

Measured in closed 50 Ohm system

— Common Mode / Asymmetrical (L-G)
— Differential Mode / Symmetrical (L-L)

1EDP



3EDP



6EDP

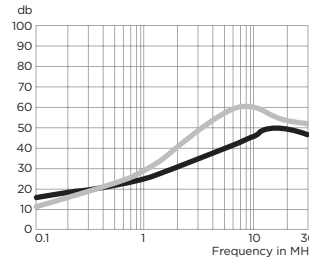

10EDP

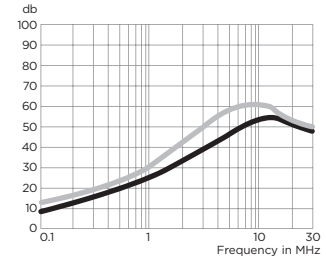

1EOP

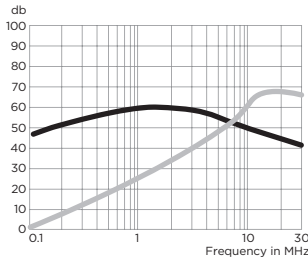

3EOP

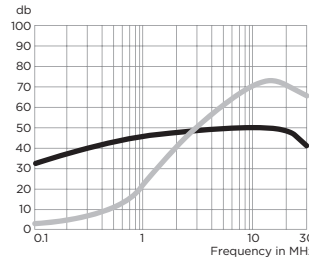

6EOP

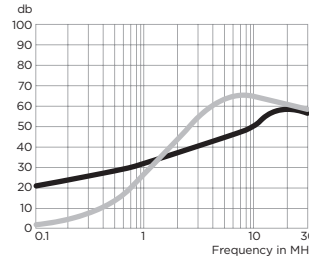

10EOP

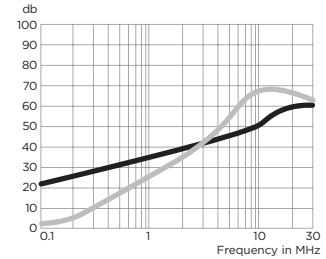

Minimum Insertion Loss

Measured in closed 50 Ohm system

Common Mode / Asymmetrical (Line to Ground)

Current Rating	Frequency – MHz					
	.15	.5	1	5	10	30
EBP Models						
1A	30	40	40	42	45	45
3A	24	29	30	42	45	45
EOP Models						
1A	32	41	54	54	46	40
3A	18	28	35	41	40	40
6A	10	20	28	37	40	40
10A	5	14	19	27	33	40
EDP Models						
1A	32	41	54	54	46	40
3A	18	28	35	41	40	40
6A	10	20	28	37	40	40
10A	5	14	19	27	33	40

Differential Mode / Symmetrical (Line to Line)

Current Rating	Frequency – MHz							
	.15	.5	1	5	10	30		
EBP Models								
1A	-	14	25	35	33	25		
3A	-	14	15	31	34	25		
EOP Models								
1A	4	14	42	42	44	38		
3A	4	14	24	38	38	38		
6A	4	14	22	30	34	34		
10A	6	16	22	40	50	45		
EDP Models								
	Frequency – MHz							
	.15	.5	1	2	4	10	20	30
1A	1	6	19	39	48	52	38	35
3A	1	4	9	9	28	41	36	35
6A	1	4	9	9	40	40	42	35
10A	1	4	9	9	14	35	42	35

Compact and Cost-effective Dual Stage RFI Power Line Filters

EMC Series



UL Recognized
CSA Certified
VDE Approved



EMC6



EMC1

EMC Series

- Compact dual stage filter series
- Cost-effective design
- Current rating up to 30A
- High differential mode attenuation in the lower frequency range
- High common mode performance
- Suitable for switching mode power supplies

Ordering Information



Specifications

Maximum leakage current each Line to Ground:

	<i>3, 6, 10A</i>	<i>15, 20, 30A</i>
@ 120 VAC 60 Hz:	.21 mA	.73 mA
@ 250 VAC 50 Hz:	.43 mA	1.52 mA

Hipot rating (one minute):

Line to Ground:	2250 VDC
Line to Line:	1450 VDC

Rated Voltage (max):

250 VAC

Operating Frequency:

50/60 Hz

Rated Current:

3 to 30A

Operating Ambient Temperature Range

(at rated current I_r): -10°C to +40°C
In an ambient temperature (T_a) higher than +40°C the maximum operating current (I_o) is calculated as follows: $I_o = I_r \sqrt{(85-T_a)/45}$

Electrical Schematic

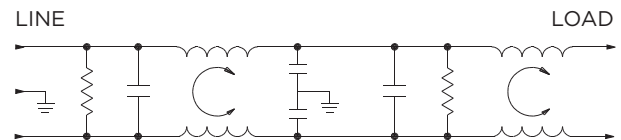

Available Part Numbers

3EMC1	10EMC3
6EMC1	15EMC3
10EMC1	10EMC6
15EMC1	15EMC6
20EMC1	20EMC6
3EMC3	30EMC6
6EMC3	

Compact and Cost-effective Dual Stage RFI Power Line Filters *(continued)*

EMC Series

Case Styles

EMC1



Typical Dimensions:

- Line/Load Terminals (4): .250 [6.3] with .07 [1.8] Dia. hole
- Ground Terminal (1): .250 [6.3] with .07 x .16 [1.8 x 3.8] slot
- Mounting Holes (2): .187 ±.008 [4.75 ±.20] Dia.

EMC3



Typical Dimensions:

- Wire leads (5): 4.0 [101.6] Min., AWG18 (AWG16 for 15A)
- Mounting Holes (2): .187 ±.008 [4.75 ±.20] Dia.

EMC6



Typical Dimensions:

- Terminals (5): 8-32, Torque 18 lbf-in. [2.03 N-m] max. ± 2 [22]
- Mounting Holes (4): .187 ±.008 [4.75 ±.20] Dia.

30EMC6



Typical Dimensions:

- Terminals (5): 10-32, Torque 27 lbf-in. [3.05 N-m] max. ± 3 [.34]
- Mounting Slots (4): .203 x .156 [5.16 x 3.96]

Case Dimensions

Part No.	A (max)	B (max)	C (max)	D (max)	E (max)
3EMC1	3.35 <i>85.1</i>	1.81 <i>46</i>	1.16 <i>29.5</i>	2.375 <i>60.3</i>	2.78 <i>70.6</i>
6EMC1	3.85 <i>97.8</i>	2.07 <i>52.6</i>	1.16 <i>29.5</i>	2.938 <i>74.6</i>	3.35 <i>85.1</i>
10EMC1	3.85 <i>97.8</i>	2.07 <i>52.6</i>	1.53 <i>38.91</i>	2.938 <i>74.6</i>	3.35 <i>85.1</i>
15EMC1	4.97 <i>126.2</i>	2.25 <i>57.2</i>	1.78 <i>45.2</i>	4.063 <i>103.2</i>	4.46 <i>113.3</i>
20EMC1	4.97 <i>126.2</i>	2.25 <i>57.2</i>	1.78 <i>45.2</i>	4.063 <i>103.2</i>	4.46 <i>113.3</i>
3EMC3	2.07 <i>52.6</i>	1.81 <i>46</i>	1.16 <i>29.5</i>	2.375 <i>60.3</i>	2.78 <i>70.6</i>
6EMC3	2.56 <i>65</i>	2.07 <i>52.6</i>	1.16 <i>29.5</i>	2.938 <i>74.6</i>	3.35 <i>85.1</i>
10EMC3	2.56 <i>65</i>	2.07 <i>52.6</i>	1.53 <i>38.9</i>	2.938 <i>74.6</i>	3.35 <i>85.1</i>
15EMC3	3.69 <i>93.7</i>	2.25 <i>57.2</i>	1.78 <i>45.2</i>	4.063 <i>103.2</i>	4.47 <i>113.5</i>
10EMC6	3.94 <i>99.9</i>	2.07 <i>52.6</i>	1.53 <i>38.9</i>	2.938 <i>74.6</i>	3.35 <i>85.1</i>
15EMC6	5.09 <i>129.3</i>	2.25 <i>57.2</i>	1.78 <i>45.2</i>	4.063 <i>103.2</i>	4.47 <i>113.5</i>
20EMC6	5.09 <i>129.3</i>	2.25 <i>57.2</i>	1.78 <i>45.2</i>	4.063 <i>103.2</i>	4.47 <i>113.5</i>
30EMC6	6.05 <i>153.7</i>	3.12 <i>79.2</i>	2.18 <i>55.4</i>	3.5 <i>88.9</i>	3.96 <i>100.6</i>

Compact and Cost-effective Dual Stage RFI Power Line Filters *(continued)*

EMC Series

Performance Data

Typical Insertion Loss

Measured in closed 50 Ohm system

3EMC



6EMC



10EMC



15EMC



20EMC



30EMC



— Common Mode / Asymmetrical (L-G)
— Differential Mode / Symmetrical (L-L)

Minimum Insertion Loss

Common Mode / Asymmetrical (Line to Ground)

Current Rating	Frequency – MHz								
	.05	.07	.11	.15	1	2	10	20	30
3A	6	6	3	16	65	66	62	60	59
6A	6	6	2	15	65	67	65	62	63
10A	5	2	13	24	72	72	56	50	48
15A	3	1	12	22	70	68	57	54	53
20A	2	2	11	21	58	57	63	55	52
30A	2	2	14	22	47	52	60	48	43

Differential Mode / Symmetrical (Line to Line)

Current Rating	Frequency – MHz								
	.05	.07	.11	.15	1	2	10	20	30
3A	12	13	7	18	64	69	65	60	52
6A	12	12	8	27	61	61	59	56	54
10A	14	15	12	33	54	58	47	34	36
15A	16	16	13	34	61	52	36	36	23
20A	17	19	15	37	67	62	36	32	30
30A	17	18	14	40	62	53	30	28	26

Dual Stage RFI Power Line Filters for Switching Mode Power Supplies

EP / VP Series



UL Recognized
CSA Certified
VDE Approved



EP & VP Series

- Dual stage filter offers high insertion loss
- Well suited for meeting CISPR 22 A and FCC Part 15J, Class B
- EP model meets very low leakage current requirements
- 7A and 12A versions offer optimum package size

Ordering Information



Electrical Schematic



*IEC 60320-1 C14 inlet mates with C13 connector

Specifications

Maximum leakage current each Line to Ground:

	VP Models	EP Models
@ 120 VAC 60 Hz:	.73 mA	.21 mA
@ 250 VAC 50 Hz:	1.27 mA	.36 mA

Hipot rating (one minute):

Line to Ground:	2250 VDC
Line to Line:	1450 VDC

Rated Voltage (max):

250 VAC

Operating Frequency:

50/60 Hz

Rated Current:

3 to 20A

Operating Ambient Temperature Range

(at rated current I_r): -10°C to +40°C
In an ambient temperature (T_a) higher than +40°C the maximum operating current (I_o) is calculated as follows: $I_o = I_r \sqrt{(85-T_a)/45}$

Available Part Numbers

3EP1	10EP1
3EP3	10EP3
3EP7	12EP1
3EP7M	12EP3
6EP1	20EP1
6EP3	20EP6
7EP1	20VP1
7EP3	20VP6

Accessories

GA400: NEMA 5-15P to IEC 60320-1 C-13 line cord



Dual Stage RFI Filters for Switching Power Supplies *(continued)*

EP / VP Series

Case Styles

EP1 / VP1 (1-15A)



Typical Dimensions:
 Line/Load Terminals (4): .250 [6.3] with .07 [1.8] Dia. hole
 Ground Terminal (1): .250 [6.3] with .07 x .16 [1.8 x 3.8] slot
 Mounting Holes (2): .188 [4.78] Dia.

EP7 & EP7M



Typical Dimensions:
 Load Terminals (2): .250 [6.3] with .07 [1.8] Dia. hole
 Line Inlet (1): IEC 60320-1 C14
 EP7 Tapped Inserts (2): 6-32 x 1/4
 EP7M Tapped Inserts (2): M3 x .5

20EP1 / VP1



Typical Dimensions:
 Line/Load Terminals (4): .250 [6.3] with .07 [1.8] Dia. hole
 Ground Terminal (1): .250 [6.3] with .07 x .16 [1.8 x 3.8] slot
 Mounting Holes (2): .188 [4.78] Dia.

20EP6 / VP6



Typical Dimensions:
 Terminals (5): 8-32, Torque 18 lbf-in. [2.03 N-m] max. ± 2 [22]
 Mounting Holes (2): .188 [4.78] Dia.

EP3



Typical Dimensions:
 Wire leads (5): 4.0 [101.6] Min, AWG18
 Mounting Holes (2): .188 [4.78] Dia.

Recommended Panel Cutout



Tolerance ± .005 [0.13]

Dual Stage RFI Filters for Switching Power Supplies (continued)

EP / VP Series

Case Dimensions

Part No.	A (max)	B (max)	C (max)	D $\pm .015$ $\pm .38$	E (max)
3EP1	3.85	2.07	1.78	2.938	3.35
3EP3	97.8	52.6	45.2	74.63	85.1
3EP7/7M	2.56	2.07	1.78	2.938	3.35
	65.0	52.6	45.2	74.63	85.1
6EP1	3.21	2.25	1.78	1.575	0.63*
	81.5	57.2	45.2	40.01	12.1*
6EP3	6.62	2.07	2.28	5.625	6.03
	168.1	52.6	57.9	142.88	153.2
7EP1	5.33	2.07	2.28	5.625	6.03
	135.4	52.6	57.9	142.88	153.2
7EP3	4.79	2.07	1.53	3.947	4.33
	121.7	52.6	38.9	10.25	109.98
10EP1	3.50	2.07	1.53	3.947	4.33
	88.9	52.6	38.9	100.25	109.98
10EP3	6.62	2.07	2.78	5.625	6.03
	168.1	52.6	70.6	142.88	153.2
12EP1	5.35	2.03	2.78	5.625	6.03
	135.9	52.6	70.6	142.88	153.2
12EP3	4.97	1.78	1.78	4.063	4.46
	126.2	45.2	45.2	103.20	113.28
20EP1/VP1	3.624	1.78	1.78	4.063	4.46
	92.05	45.2	45.2	103.20	113.28
20EP6/VP6	4.95	1.8	1.8	4.063	4.47
	125.7	45.7	45.7	103.20	113.5
	5.09	1.78	1.78	4.063	4.46
	127.3	45.2	45.2	103.20	113.3

*±0.02 [0.5]

Performance Data

Typical Insertion Loss

Measured in closed 50 Ohm system

3EP



6EP



7EP



10EP



Typical Insertion Loss (continued)

12EP



20EP



20VP



— Common Mode / Asymmetrical (L-G)
— Differential Mode / Symmetrical (L-L)

Minimum Insertion Loss

Measured in closed 50 Ohm system

Common Mode / Asymmetrical (Line to Ground)

Current Rating	Frequency – MHz							
	.01	.05	.15	.5	1	5	10	30
EP Models								
3A	12	10	58	65	65	66	62	30
6, 10A	10	15	60	65	65	65	60	35
7A	15	28	63	75	78	75	75	55
12A	12	7	52	68	70	70	70	45
20A	3	6	28	50	55	60	55	55

VP Models

20A	3	2	42	60	65	65	55	55
-----	---	---	----	----	----	----	----	----

Differential Mode / Symmetrical (Line to Line)

Current Rating	Frequency – MHz							
	.01	.05	.15	.5	1	5	10	30
EP Models								
3A	1	3	36	65	65	65	58	58
6, 10A	1	3	30	65	65	65	65	35
7A	10	13	55	65	68	70	65	50
12A	11	7	43	70	70	70	65	45
20A	8	25	60	65	65	58	58	58

VP Models

20A	8	-	25	60	65	65	58	58
-----	---	---	----	----	----	----	----	----



RFI Power Line Filters

Single Phase Power Line Filter for Frequency Converters

FC Series



UL Recognized



FC Series

- Designed for frequency inverters and variable speed motor drives
- Suitable for electronically noisy environments
- Protects programmable logic controllers from RF noise on the AC power line
- Side flanges for easy mounting
- Touch safe terminals provide easy connections and prevent inadvertent contact for safety in the most demanding applications

Ordering Information



Available Part Numbers

6FC10	
12FC10	12FC10B
16FC10	16FC10B
25FC10	25FC10B
36FC10	36FC10B
50FC10	50FC10B

Specifications

Maximum leakage current each Line to Ground:

	<u>B suffix</u>	<u>no suffix</u>
@ 120 VAC 60 Hz:	3.9 mA	3.8 mA
@ 250 VAC 50 Hz:	7.0 mA	6.7 mA

Hipot rating (one minute):

Line to Ground:	2250 VDC
Line to Line:	1450 VDC

Rated Voltage (max):

250 VAC

Operating Frequency:

50/60 Hz

Rated Current:

6 to 50A

Operating Ambient Temperature Range

(at rated current I_r): -10°C to +40°C
In an ambient temperature (T_a) higher than +40°C the maximum operating current (I_o) is calculated as follows: $I_o = I_r \sqrt{(85-T_a)/45}$

Electrical Schematics

FC10



FC10B



Single Phase Filter for Frequency Converters *(continued)*

FC Series

Case Styles

FC10 / FC10B (6, 12, 16A)



Typical Dimensions:

- Line/Load Terminals (4): DIN type accepts 10AWG solid / 12AWG stranded
- Ground Terminals (2): 8-32 screw terminals
- Mounting Holes (4): .203 x .156 [5.16 x 3.96]

FC10 / FC10B (25, 36, 50A)



Typical Dimensions:

- Line/Load Terminals (4): DIN type accepts 8AWG solid / 10AWG stranded
- Ground Terminals (2): 8-32 screw terminals
- Mounting Slots (4): .260 [6.6] wide

Case Dimensions

Part No.	A (max)	B (max)	C (max)	D $\pm .020$ $\pm .510$	E (max)	F $\pm .010$ $\pm .254$
6FC10	4.60 <i>116.8</i>	3.10 <i>78.7</i>	1.78 <i>45.21</i>	2.677 <i>67.8</i>	3.70 <i>94.0</i>	2.0 <i>50.8</i>
12FC10/10B	5.47	3.96	2.18	3.50	4.53	2.0
16FC10/10B	<i>139.0</i>	<i>100.6</i>	<i>55.4</i>	<i>88.9</i>	<i>114.8</i>	<i>5.08</i>
25, 36, 50	6.90	5.48	2.55	4.90	5.94	2.756
FC10/10B	<i>175.3</i>	<i>139.2</i>	<i>64.77</i>	<i>124.5</i>	<i>150.9</i>	<i>70.0</i>

1
RFI Power Line Filters

Single Phase Filter for Frequency Converters *(continued)*

FC Series

Performance Data

Typical Insertion Loss

Measured in closed 50 Ohm system

— Common Mode / Asymmetrical (L-G)
— Differential Mode / Symmetrical (L-L)



Minimum Insertion Loss

Common Mode / Asymmetrical (Line to Ground)

Differential Mode / Symmetrical (Line to Line)

Part No.	Frequency – MHz								
	.01	.03	.05	.1	.5	1	5	10	30
6FC10	9	19	26	37	65	65	50	40	35
12FC10	5	17	25	37	65	65	65	60	35
16FC10	4	15	22	36	65	65	70	70	35
25FC10	2	14	22	36	75	75	70	70	48
36, 50FC10	-	6	14	27	68	75	70	70	50
12, 16FC10B	16	28	37	50	81	76	63	55	38
25FC10B	14	25	36	49	91	88	71	64	46
36FC10B	11	25	37	50	81	87	73	66	49
50FC10B	11	24	36	49	81	75	62	54	37

Part No.	Frequency – MHz								
	.01	.03	.05	.1	.5	1	5	10	30
6FC10	10	10	35	60	75	75	60	50	45
12FC10	14	14	30	51	75	75	75	70	45
16FC10	14	14	29	55	75	75	75	70	45
25FC10	14	14	17	42	75	75	70	70	50
36, 50FC10	14	14	17	42	75	75	70	70	50
12, 16FC10B	30	32	46	64	91	86	77	78	65
25FC10B	24	24	31	46	92	87	86	75	55
36FC10B	27	33	27	41	89	88	82	74	55
50FC10B	30	32	48	64	91	87	82	79	67

Differential Mode Filter for Fluorescent Lighting Applications

FL Series



UL Listed



FL Series

- Specifically designed for fluorescent lights
- Suitable for industrial environments
- UL Listed for aftermarket installation

Ordering Information



Available Part Number

3FL3	
------	--

Specifications

- Maximum leakage current each Line to Ground:**
 @ 125 VAC 60 Hz: 3.0 mA
 @280 VAC 50 Hz: 6.0 mA
- Hipot rating (one minute):**
 Line to Ground: 1560 VAC
 Line to Line: 1560 VAC
- Rated Voltage:** 125/280 VAC
- Operating Frequency:** 50/60 Hz
- Rated Current:** 3.9 A
- Operating Ambient Temperature Range (at rated current I_r):** -10°C to +40°C
 In an ambient temperature (T_a) higher than +40°C the maximum operating current (I_o) is calculated as follows: $I_o = I_r \sqrt{(85-T_a)/45}$

Electrical Schematic



Differential Mode Filter for Fluorescent Lighting Applications *(continued)*

FL Series

Case Styles



Case Dimensions

Part No.	A (max)	B (max)	C (max)	D $\pm .015$ $\pm .38$	E (max)
3FL3	3.35	2.07	1.16	2.938	2.57
	85.09	52.58	29.5	74.63	65.3

Performance Data

Typical Insertion Loss

Measured in closed 50 Ohm system



— Differential Mode / Symmetrical (L-L)

Minimum Insertion Loss

Differential Mode / Symmetrical (Line to Line)

Part No.	Frequency – MHz						
	.15	.3	.6	1	4	10	20
3FL3	10	18	34	46	56	38	26

High Performance RFI Filters for Switching Power Supplies

G Series



UL Recognized
CSA Certified
VDE Approved



RFI Power Line Filters

G Series

- Designed to provide excellent attenuation for most digital electronics equipment
- Broad frequency range of performance from 20kHz to 30MHz
- Size and cost-effective solution
- Designed to help comply with EN55022 Level A and FCC Part 15J Class B

Ordering Information

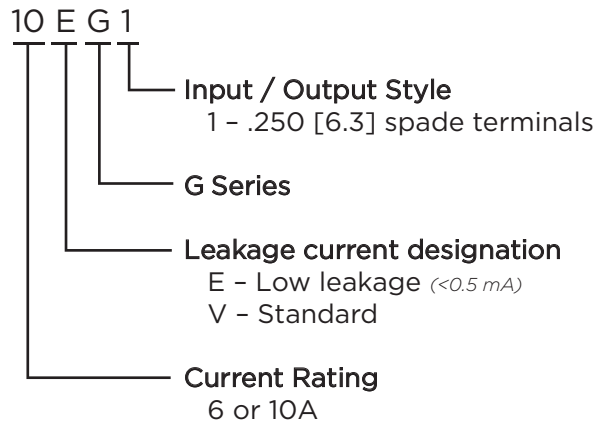

Available Part Numbers

6EG1	6VG1
10EG1	10VG1

Specifications

Maximum leakage current each Line to Ground:

	EG Models	VG Models
@ 120 VAC 60 Hz:	.30 mA	1.2 mA
@ 250 VAC 50 Hz:	.50 mA	2.0 mA

Hipot rating (one minute):

Line to Ground:	2250 VDC
Line to Line:	1450 VDC

Rated Voltage (max): 250 VAC

Operating Frequency: 50/60 Hz

Rated Current: 6 & 10A

Operating Ambient Temperature Range

(at rated current I_r): -10°C to +40°C
In an ambient temperature (T_a) higher than +40°C the maximum operating current (I_o) is calculated as follows: $I_o = I_r \sqrt{(85-T_a)/45}$

Electrical Schematics

6EG1 & 6VG1

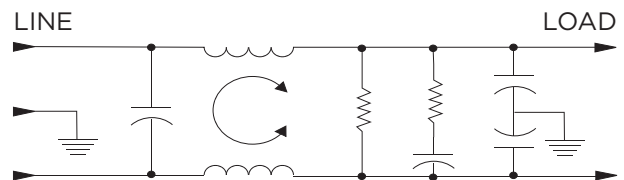

10EG1 & 10VG1

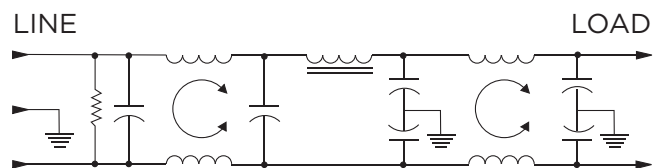

High Performance RFI Filters for Switching Power Supplies *(continued)*

G Series

Case Styles

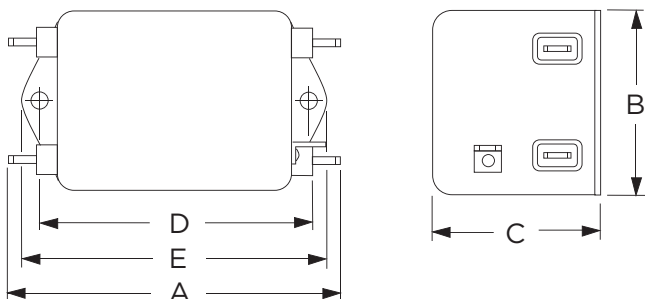

Typical Dimensions:

- Line/Load Terminals (4): .250 [6.3] with .07 [1.8] Dia. hole
- Ground Terminal (1): .250 [6.3] with .07 x .16 [1.8 x 3.8] slot
- Mounting Holes (2): .188 [4.78] Dia.

Case Dimensions

Part No.	A (max)	B (max)	C (max)	D $\pm .015$ $\pm .38$	E (max)
6EG1/VG1	3.56 <i>90.4</i>	2.15 <i>54.6</i>	1.56 <i>39.6</i>	2.938 <i>74.63</i>	3.38 <i>85.8</i>
10EG1/VG1	4.69 <i>119.1</i>	2.27 <i>57.7</i>	1.8 <i>45.7</i>	4.063 <i>103.2</i>	4.47 <i>113.5</i>

Performance Data

Typical Insertion Loss

Measured in closed 50 Ohm system

— Common Mode / Asymmetrical (L-G)
— Differential Mode / Symmetrical (L-L)

6EG1

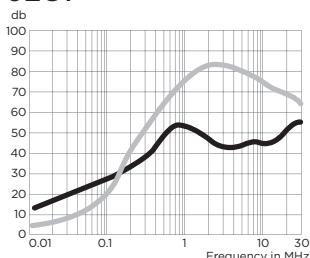

6VG1



10EG1



10VG1

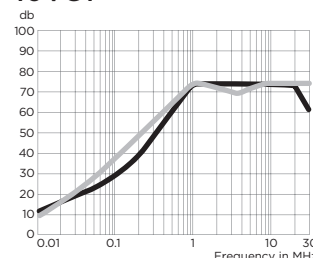

Minimum Insertion Loss

Common Mode / Asymmetrical (Line to Ground)

Current Rating	Frequency – MHz									
	.01	.05	.07	.1	.15	.5	1	5	10	30
EG Models										
6A	6	19	23	25	29	48	44	43	40	40
10A	8	10	15	18	42	64	65	65	60	60
VG Models										
6A	4	18	21	25	30	56	55	53	45	45
10A	5	10	24	37	50	72	70	70	60	60

Differential Mode / Symmetrical (Line to Line)

Current Rating	Frequency – MHz									
	.01	.05	.07	.1	.15	.5	1	5	10	30
EG Models										
6A	4	6	10	24	37	66	75	72	50	50
10A	5	5	5	26	40	65	65	60	70	70
VG Models										
6A	4	7	7	26	39	67	75	68	55	55
10A	5	5	7	26	39	65	60	60	70	70

Highest Performance RFI Filters for Medical Equipment

HQ Series



UL Recognized
CSA Certified
VDE Approved



HQ Series

- Designed to provide the highest available attenuation of RFI noise in the frequency range from 10kHz to 30MHz for low leakage current applications
- Size and cost-effective

Ordering Information



*IEC 60320-1 C14 inlet mates with C13 connector

Specifications

Maximum leakage current each Line to Ground:
 @ 120 VAC 60 Hz: 2 µA
 @ 250 VAC 50 Hz: 5 µA

Hipot rating (one minute):
 Line to Ground: 2250 VDC
 Line to Line: 1450 VDC

Rated Voltage (max): 250 VAC

Operating Frequency: 50/60 Hz

Rated Current: 3 & 6A

Operating Ambient Temperature Range
 (at rated current I_r): -10°C to +40°C
 In an ambient temperature (T_a) higher than +40°C
 the maximum operating current (I_o) is calculated as
 follows: $I_o = I_r \sqrt{(85-T_a)/45}$

Available Part Numbers

3EHQ1	6EHQ1
3EHQ3	6EHQ3
3EHQ8	6EHQ8
3EHQ8M	3EHQ8M

Accessories

GA400: NEMA 5-15P to IEC 60320-1 C-13 line cord



Highest Performance RFI Filters for Medical Equipment *(continued)*

HQ Series

Electrical Schematics

3EHQ



6EHQ



Case Styles

HQ1



Typical Dimensions:
 Line/Load Terminals (4): .250 [6.3] with .07 [1.8] Dia. hole
 Ground Terminal (1): .250 [6.3] with .07 x .16 [1.8 x 3.8] slot
 Mounting Holes (2): .188 [4.78] Dia.

HQ3



Typical Dimensions:
 Wire Leads (5): 4.0 [101.6] Min.
 Mounting Holes (2): .188 [4.78] Dia.

3EHQ8 & 3EHQ8M



Typical Dimensions:
 Wire Leads (3): 4.0 [101.6] Min.
 Line Inlet (1): IEC 60320-1 C14
 HQ8 Tapped Inserts (2): 6-32 x 1/4
 HQ8M Tapped Inserts (2): M3 x .5

6EHQ8 & 6EHQ8M



Typical Dimensions:
 Wire Leads (3): 4.0 [101.6] Min.
 Line Inlet (1): IEC 60320-1 C14
 HQ8 Tapped Inserts (2): 6-32 x 1/4
 HQ8M Tapped Inserts (2): M3 x .5

Highest Performance RFI Filters for Medical Equipment *(continued)*

HQ Series

Recommended Panel Cutout



Case Dimensions

Part No.	A (max)	B (max)	C (max)	D $\pm .015$ $\pm .38$	E (max)
3EHQ1	3.85 97.8	2.07 52.6	1.78 45.2	2.938 74.63	3.34 84.8
3EHQ3	2.56 65.0	2.07 52.6	1.78 45.2	2.938 74.63	3.34 84.8
3EHQ8, 3EHQ8M	3.07 78.0	2.25 57.2	1.78 45.2	1.575 40.01	0.63* 16.0*
6EHQ1	4.98 126.5	2.27 57.7	1.8 45.7	4.063 103.2	4.47 113.5
6EHQ3	3.69 93.7	2.27 57.7	1.8 45.7	4.063 103.2	4.47 113.5
6EHQ8, 6EHQ8M	5.47 138.9	2.07 52.6	1.78 45.2	1.575 40.01	2.7* 68.6*

*±0.02 [0.5]

1
RFI Power Line Filters

Performance Data

Typical Insertion Loss

Measured in closed 50 Ohm system

3EHQ



6EHQ



— Common Mode / Asymmetrical (L-G)
- - - Differential Mode / Symmetrical (L-L)

Minimum Insertion Loss

Measured in closed 50 Ohm system

Common Mode / Asymmetrical (Line to Ground)

Current Rating	Frequency – MHz											
	.01	.02	.05	.15	.5	1	2	5	7	10	20	30
3A	19	24	32	44	44	40	38	28	25	22	13	10
6A	24	29	39	42	28	35	36	30	30	24	16	15

Differential Mode / Symmetrical (Line to Line)

Current Rating	Frequency – MHz											
	.01	.02	.05	.15	.5	1	2	5	7	10	20	30
3A	1	18	43	68	75	75	72	70	66	65	60	60
6A	6	10	43	70	75	75	75	65	50	55	50	40

High Performance RFI Power Line Filters for Medical Equipment

HT Series



UL Recognized
CSA Certified
VDE Approved



HT Series

- Designed to provide significant attenuation of RFI noise in the frequency range from 10kHz to 30MHz
- Size and cost-effective

Ordering Information

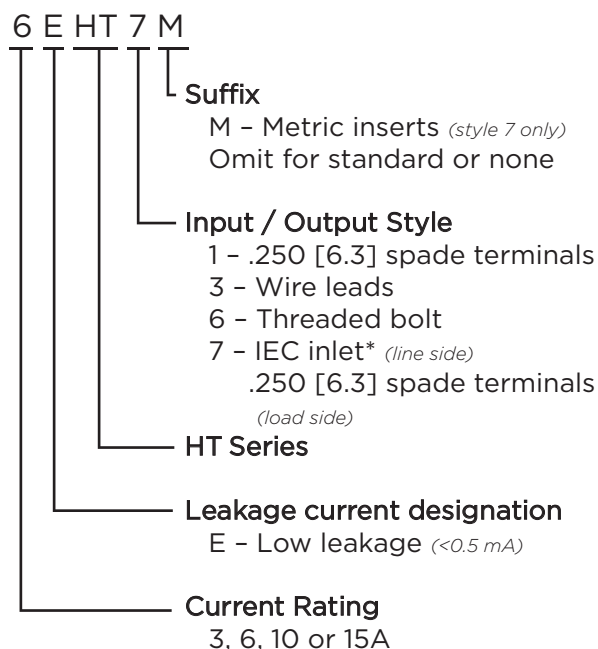

*IEC 60320-1 C14 inlet mates with C13 connector

Specifications

- Maximum leakage current each Line to Ground:**
 @ 120 VAC 60 Hz: 2 μ A
 @ 250 VAC 50 Hz: 5 μ A
- Hipot rating (one minute):**
 Line to Ground: 2250 VDC
 Line to Line: 1450 VDC
- Rated Voltage (max):** 250 VAC
- Operating Frequency:** 50/60 Hz
- Rated Current:** 3 to 15A
- Operating Ambient Temperature Range (at rated current I_r):** -10°C to +40°C
 In an ambient temperature (T_a) higher than +40°C the maximum operating current (I_o) is calculated as follows: $I_o = I_r \sqrt{(85-T_a)/45}$

Available Part Numbers

3EHT1	6EHT7
3EHT3	6EHT7M
3EHT7	10EHT1
3EHT7M	10EHT3
6EHT1	15EHT1
6EHT3	15EHT6

Accessories

GA400: NEMA 5-15P to IEC 60320-1 C-13 line cord

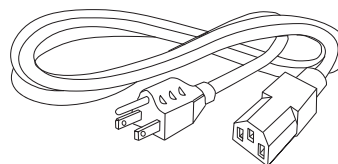

High Performance Power Line Filters for Medical Equipment *(continued)*

HT Series

Electrical Schematics

3 & 6EHT

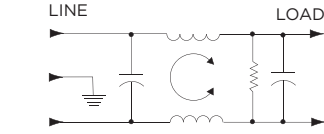

10EHT

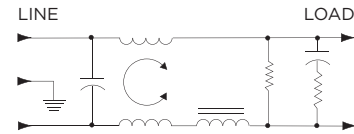

15EHT

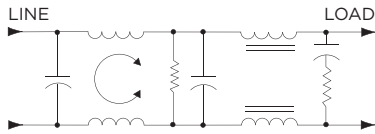

Case Styles

HT1 (3, 6, 10A)



Typical Dimensions:
 Line/Load Terminals (4): .250 [6.3] with .07 [1.8] Dia. hole
 Ground Terminal (1): .250 [6.3] with .07 x .16 [1.8 x 3.8] slot
 Mounting Holes (2): .188 [4.78] Dia.

HT1 (15A)



Typical Dimensions:
 Line/Load Terminals (4): .250 [6.3] with .07 [1.8] Dia. hole
 Ground Terminal (1): .250 [6.3] with .07 x .16 [1.8 x 3.8] slot
 Mounting Slots (4): .203 x .156 [5.16 x 3.96] Dia.

HT3



Typical Dimensions:
 6A Wire Leads (5): 4.0 [101.6] Min., 18AWG
 10A Wire Leads (5): 6.0 [152.4] Min., 18AWG
 Mounting Holes (2): .188 [4.78] Dia.

HT6



Typical Dimensions:
 Terminals (5): 8-32, Torque 18 lbf-in. [2.03 N-m] max. ± 2 [22]
 Mounting Slots (4): .203 x .156 [5.16 x 3.96] Dia.

HT7 & HT7M



Typical Dimensions:
 Load Terminals (2): .250 [6.3] with .07 [1.8] Dia. hole
 Ground Terminal (1): .250 [6.3] with .07 x .16 [1.8 x 3.8] slot
 Line Inlet (1): IEC 60320-1 C14
 HT7 Tapped Inserts (2): 6-32 x 1/4
 HT7M Tapped Inserts (2): M3 x .5

1
RFI Power Line Filters

High Performance Power Line Filters for Medical Equipment *(continued)*

HT Series

Recommended Panel Cutout



Case Dimensions

Part No.	A (max)	B (max)	C (max)	D $\pm .015$ $\pm .38$	E (max)
3EHT1,	3.56	2.15	1.81	2.938	3.38
6EHT1	90.4	54.6	46.0	74.63	85.9
3EHT3,	2.55	2.15	1.81	2.938	3.38
6EHT3	64.8	54.6	46.0	74.63	85.9
3EHT7 / 7M,	3.52	2.25	1.78	1.575	0.63*
6EHT7 / 7M	89.4	57.2	45.2	40.01	16.0*
10EHT1	4.69	2.27	1.8	4.063	4.47
	119.1	57.7	45.7	103.2	113.5
10EHT3	3.69	2.27	1.8	4.063	4.47
	93.7	57.7	45.7	103.2	113.5
15EHT1	5.45	3.12	2.18	3.5	3.96
	138.4	79.2	55.4	88.9	100.6
15EHT6	5.95	3.12	2.18	3.5	3.96
	151.1	79.2	55.4	88.9	100.6

*±0.02 [0.5]

Performance Data

Typical Insertion Loss

Measured in closed 50 Ohm system

— Common Mode / Asymmetrical (L-G)
— Differential Mode / Symmetrical (L-L)

3EHT

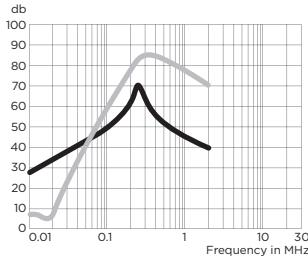

6EHT



10EHT



15EHT



Minimum Insertion Loss

Common Mode / Asymmetrical (Line to Ground)

Current Rating	Frequency – MHz											
	.02	.02	.05	.08	.15	.5	1	2	5	10	20	30
3A	22	32	36	-	49	46	40	30	22	12	12	12
6A	16	23	32	41	46	41	33	26	15	9	6	2
10A	9	15	24	30	36	42	34	22	11	12	8	8
15A	4	9	18	22	27	41	34	22	12	12	5	2

Differential Mode / Symmetrical (Line to Line)

Current Rating	Frequency – MHz											
	.02	.02	.05	.08	.15	.5	1	2	5	10	20	30
3A	3	1	30	-	61	70	65	65	48	40	32	32
6A	4	1	14	45	51	70	70	65	55	47	37	37
10A	7	8	17	32	52	70	70	70	65	55	40	35
15A	12	16	15	10	51	70	70	70	70	70	65	55

High Performance Power Line Filter for Medical Applications

HZ Series



UL Recognized
CSA Certified
VDE Approved



HZ Series

- Designed to provide good attenuation to RFI noise in the frequency range from 10kHz to 30MHz
- Size and cost-effective
- Low leakage current
- New versions up to 30A

Ordering Information



Available Part Numbers

3EHZ1	4EHZ1
6EHZ1	10EHZ1
15EHZ1	20EHZ1
30EHZ6	

Electrical Schematic



Specifications

- Maximum leakage current each Line to Ground:**
 @ 120 VAC 60 Hz: 2 μ A
 @ 250 VAC 50 Hz: 5 μ A
- Hipot rating (one minute):**
 Line to Ground: 2250 VDC
 Line to Line: 1450 VDC
- Rated Voltage (max):** 250 VAC
- Operating Frequency:** 50/60 Hz
- Rated Current:** 3 to 30A
- Operating Ambient Temperature Range (at rated current I_r):** -10°C to +40°C
 In an ambient temperature (T_a) higher than +40°C the maximum operating current (I_o) is calculated as follows: $I_o = I_r \sqrt{(85-T_a)/45}$

Case Styles

3EHZ1



- Typical Dimensions:
- Line/Load Terminals (4): .250 [6.3] with .07 [1.8] Dia. hole
 - Ground Terminal (1): .250 [6.3] with .07 x .16 [1.8 x 3.8] slot
 - Mounting Holes (2): .188 [4.78] Dia.

High Performance Power Line Filter for Medical Applications *(continued)*

HZ Series

Case Styles *(continued)*

4EHZ1



Typical Dimensions:

Line/Load Terminals (4): .250 [6.3] with .07 [1.8] Dia. hole
Ground Terminal (1): .250 [6.3] with .07 x .16 [1.8 x 3.8] slot
Mounting Holes (2): .188 [4.78] Dia.

6EHZ1



Typical Dimensions:

Line/Load Terminals (4): .250 [6.3] with .07 [1.8] Dia. hole
Ground Terminal (1): .250 [6.3] with .07 x .16 [1.8 x 3.8] slot
Mounting Holes (2): .188 [4.78] Dia.

10, 15 & 20EHZ1



Typical Dimensions:

Line/Load Terminals (4): .250 [6.3] with .07 [1.8] Dia. hole
Ground Terminal (1): .250 [6.3] with .07 x .16 [1.8 x 3.8] slot
Mounting Holes (2): .188 [4.78] Dia.

30EHZ6

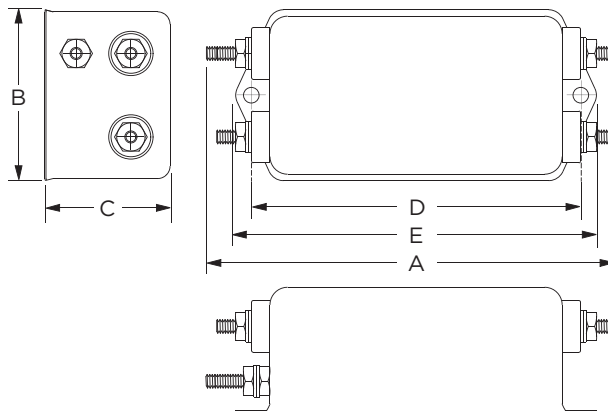

Typical Dimensions:

Terminals (5): 8-32, Torque 18 lbf-in. [2.03 N-m] max. ± 2 [2.2]
Mounting Holes (4): .188 [4.75] Dia.

Case Dimensions

Part No.	A (max)	B (max)	C (max)	D $\pm .015$ $\pm .38$	E (max)
3EHZ1	<i>3.54</i> 89.91	<i>2.08</i> 52.8	<i>1.31</i> 33.3	<i>2.938</i> 74.63	<i>3.35</i> 85.1
4EHZ1	<i>3.07</i> 77.98	<i>1.82</i> 46.23	<i>1.16</i> 29.46	<i>2.375</i> 60.33	<i>2.78</i> 70.61
6EHZ1	<i>3.07</i> 77.98	<i>1.82</i> 46.23	<i>1.28</i> 32.51	<i>2.375</i> 60.33	<i>2.78</i> 70.61
10EHZ1	<i>3.54</i>	<i>2.047</i>	<i>1.805</i>	<i>2.938</i>	<i>3.54</i>
15EHZ1	<i>89.92</i>	<i>51.99</i>	<i>45.85</i>	<i>74.63</i>	<i>89.92</i>
20EHZ1	<i>89.92</i>	<i>51.99</i>	<i>45.85</i>	<i>74.63</i>	<i>89.92</i>
30EHZ6	<i>4.92</i> 124.97	<i>2.07</i> 52.58	<i>1.53</i> 38.86	<i>3.947</i> 100.25	<i>4.33</i> 109.98

High Performance Power Line Filter for Medical Applications *(continued)*

Performance Data

Typical Insertion Loss

Measured in closed 50 Ohm system

3EHZ1



4EHZ1



6EHZ1



10EHZ1



15EHZ1



20EHZ1

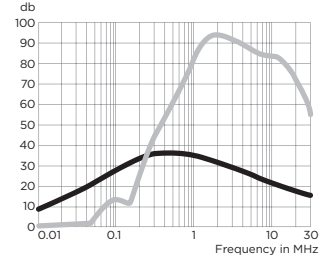

30EHZ6



— Common Mode / Asymmetrical (L-G)
— Differential Mode / Symmetrical (L-L)

Minimum Insertion Loss

Common Mode / Asymmetrical (Line to Ground)

Differential Mode / Symmetrical (Line to Line)

Part No.	Frequency – MHz								
	.01	.05	.1	.15	.5	1	5	10	30
3EHZ1	10	24	30	34	34	35	15	10	5
4EHZ1	12	24	31	35	47	47	30	25	18
6EHZ1	9	21	27	30	36	34	27	22	16
10EHZ1	7	21	25	31	43	40	26	21	14
15EHZ1	7	27	27	30	43	37	24	17	12
20EHZ1	5	19	24	28	31	29	14	9	4
30EHZ6	-	5	11	14	27	30	20	17	14

Part No.	Frequency – MHz								
	.01	.05	.1	.15	.5	1	5	10	30
3EHZ1	10	25	30	54	70	70	65	55	55
4EHZ1	-	-	14	32	72	83	68	63	30
6EHZ1	-	-	7	17	59	80	67	60	52
10EHZ1	-	-	4	21	63	80	80	74	36
15EHZ1	-	-	7	15	51	77	80	74	48
20EHZ1	-	-	11	9	54	77	74	69	47
30EHZ6	-	-	13	14	47	67	76	70	58

Single and 2-phase RFI Filters for Industrial Applications

IK Series



IK Series

- Excellent performance for applications with high interference levels
- Designed for single or two-phase applications
- Wide current range
- For small to medium sized industrial equipment, power converters and variable speed motors
- Touch safe terminals on the 6 to 60A product provide easy connections and prevent inadvertent contact for safety in the most demanding applications

Ordering Information

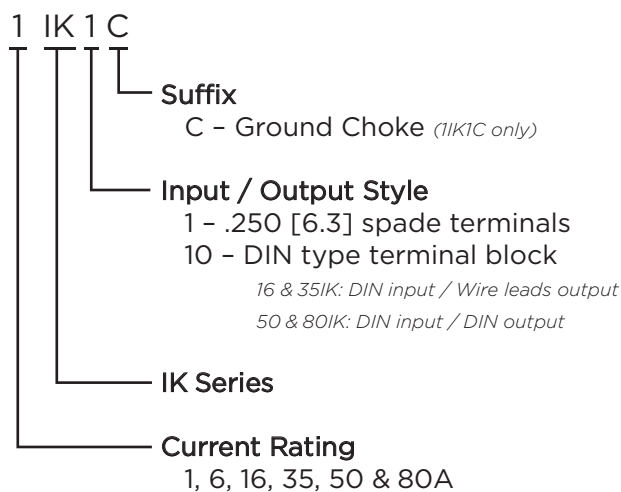

Available Part Number

1IK1C	6IK1
16IK10	35IK10
50IK10	80IK10

Specifications

Maximum leakage current each Line to Ground:

@120 VAC 60 Hz:	1IK & 6IK:	0.6 mA
	16, 35 & 50IK:	1.7 mA
	80IK:	5.2 mA
@289 VAC 50 Hz:	1IK:	1.2 mA
@277 VAC 50 Hz:	6IK:	1.15 mA
	16, 35 & 50IK:	3.2 mA
	80IK:	9.9 mA

Hipot rating (one minute):

Line to Ground:	2250 VDC
Line to Line:	1450 VDC

Rated Voltage (max):

	1IK	6 to 80IK
Line to Ground:	289 VAC	500 VAC
Line to Line:	277 VAC	480 VAC

Operating Frequency:

50/60 Hz

Rated Current:

1 to 80A

Operating Ambient Temperature Range

(at rated current I_r): -10°C to +40°C
In an ambient temperature (T_a) higher than +40°C the maximum operating current (I_o) is calculated as follows: $I_o = I_r \sqrt{(85-T_a)/45}$

Electrical Schematic



Note 1: 1IK1C only
Note 2: 6IK1 only

Single and 2-phase RFI Filters for Industrial Applications

IK Series

Case Styles

11K1C



Typical Dimensions:
 Line/Load Terminals (4): .250 [6.3] with .07 [1.8] Dia. hole
 Ground Terminal (1): .250 [6.3] with .07 x .16 [1.8 x 3.8] slot
 Mounting Holes (2): .188 [4.78] Dia.

6IK1

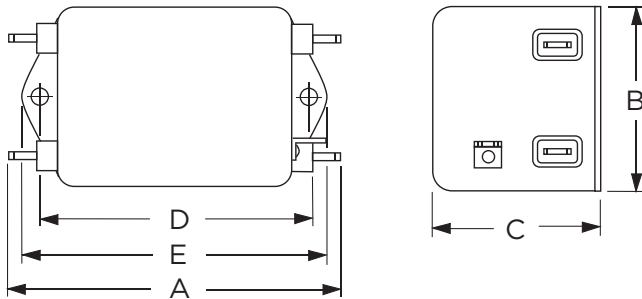

Typical Dimensions:
 Line/Load Terminals (4): .250 [6.3] with .07 [1.8] Dia. hole
 Ground Terminal (1): .250 [6.3] with .07 x .16 [1.8 x 3.8] slot
 Mounting Holes (2): .188 [4.78] Dia.

16 & 35IK10



Typical Dimensions:
 Input Terminals (3): DIN type terminal block
 Output Wire Leads (2): 7.0 [180.0] min.
 Mounting Holes (4): .216 [5.5] dia.

50 & 80IK10

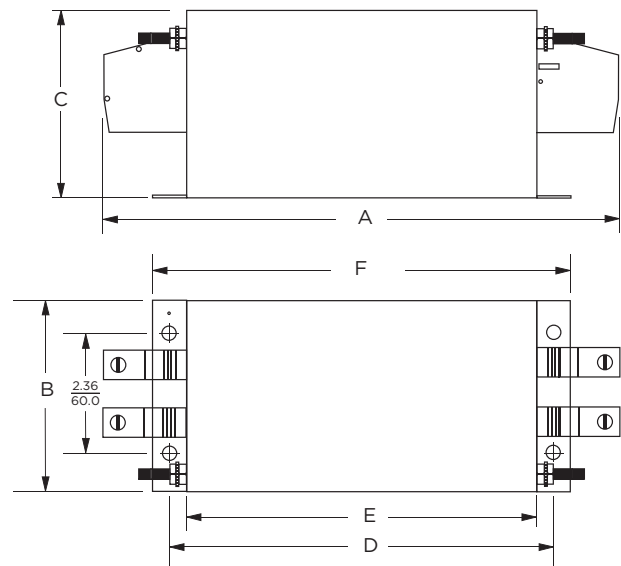

Typical Dimensions:
 Line / Load terminals (4): DIN type terminal block
 Ground terminals (2): 1/4-20 screw
 Mounting Holes (4): .260 [6.5] dia.

1
RFI Power Line Filters

Single and 2-phase RFI Filters for Industrial Applications

IK Series

Case Dimensions

Part No.	A (max)	B (max)	C (max)	D $\pm .020$ $\pm .510$	E (max)	F $\pm .010$ $\pm .254$
1IK1C	3.85 <i>97.8</i>	2.07 <i>52.6</i>	1.53 <i>38.9</i>	2.93 <i>74.4</i>	3.35 <i>85.1</i>	-
6IK1	4.69 <i>119.1</i>	2.27 <i>57.7</i>	1.8 <i>45.7</i>	4.063 <i>103.2</i>	4.47 <i>113.5</i>	-
16IK10	6.28 <i>159.5</i>	1.97 <i>50.0</i>	4.76 <i>121.0</i>	5.90 <i>150.0</i>	5.35 <i>136.0</i>	6.34 <i>161.0</i>
35IK10	6.48 <i>164.5</i>	1.97 <i>50.0</i>	4.76 <i>121.0</i>	5.90 <i>150.0</i>	5.35 <i>136.0</i>	6.34 <i>161.0</i>
50IK10	9.45	3.94	3.54	6.89	6.3	7.48
80IK10	<i>240.0</i>	<i>100.0</i>	<i>90.0</i>	<i>175.0</i>	<i>160.0</i>	<i>190.0</i>

Performance Data

Typical Insertion Loss

Measured in closed 50 Ohm system



— Common Mode / Asymmetrical (L-G)
— Differential Mode / Symmetrical (L-L)

General Purpose RFI Power Line Filters - Ideal for High Impedance Load

K Series



UL Recognized
CSA Certified
VDE Approved**



K Series

- Suitable for high impedance loads
- Well suited to applications where pulsed, continuous and/or intermittent RFI interference is present
- EK models meet the very low leakage current requirements for VDE portable equipment and non-patient care medical equipment
- Available with ground line inductor (choke)

Ordering Information



*1-15A: IEC 60320-1 C14 inlet mates with C13 connector
20VK7: C20 inlet mates with C19 connector

Specifications

Maximum leakage current each Line to Ground:

	VK Models	EK Models
@ 120 VAC 60 Hz:	.5 mA	.21 mA
@ 250 VAC 50 Hz:	1.0 mA	.36 mA

Hipot rating (one minute):

Line to Ground:	2250 VDC
Line to Line:	1450 VDC

Rated Voltage (max):

250 VAC

Operating Frequency:

50/60 Hz

Rated Current:

1 to 60A*

Operating Ambient Temperature Range

(at rated current I_r): -10°C to +40°C

In an ambient temperature (T_a) higher than +40°C the maximum operating current (I_o) is calculated as follows: $I_o = I_r \sqrt{(85-T_a)/45}$

Available Part Numbers

1VK1	10VK6	2EK3
1VK3	10VK7	3EK1
2VK1	10VK7M	3EK3
2VK3	20VK1	3EK7
3VK1	20VK6	3EK7M
3VK3	20VK7*	5EK1
3VK7	30VK6	5EK3
3VK7M	30VK6C	5EK7
5VK1	40VK6	5EK7M
5VK3	40VK6C	10EK1
5VK7	60VK6	10EK3
5VK7M	1EK1	10EK7
10VK1	1EK3	10EK7M
10VK3	2EK1	20EK1

**20VK7, 20A model tested by Underwriters Laboratories to US and Canadian requirements and is VDE approved at 16A, 250VAC

General Purpose RFI Power Line Filters *(continued)*

K Series

Electrical Schematics



30 & 40VK6C *(Inductor in Ground Line)*



60VK6



Accessories

GA400: NEMA 5-15P to IEC 60320-1 C-13 line cord



Case Styles

K1 (1, 2, 3, 6, 10A)



Typical Dimensions:
 Line/Load Terminals (4): .250 [6.3] with .07 [1.8] Dia. hole
 Ground Terminal (1): .250 [6.3] with .07 x .16 [1.8 x 3.8] slot
 Mounting Holes (2): .188 [4.78] Dia.

K1 (20A)



Typical Dimensions:
 Line/Load Terminals (4): .250 [6.3] with .07 [1.8] Dia. hole
 Ground Terminal (1): .250 [6.3] with .07 x .16 [1.8 x 3.8] slot
 Mounting Holes (2): .188 [4.78] Dia.

K3



Typical Dimensions:
 Wire Leads (5): 4.0 [101.6] Min., AWG18 (AWG16 for 10A)
 Mounting Holes (2): .188 [4.78] Dia.

General Purpose RFI Power Line Filters (continued)

K Series

Case Styles (continued)

10VK6



Typical Dimensions:
 Terminals (5): 8-32, Torque 18 lbf-in. [2.03 N-m] max. ± 2 [.22]
 Mounting Holes (2): .188 [4.78] Dia.

20VK6



Typical Dimensions:
 Terminals (5): 8-32, Torque 18 lbf-in. [2.03 N-m] max. ± 2 [.22]
 Mounting Holes (2): .188 [4.78] Dia.

30VK6/6C & 40VK6/6C



Typical Dimensions:
 Terminals (5): 8-32, Torque 18 lbf-in. [2.03 N-m] max. ± 2 [.22]
 Mounting Slots (4): .250 x .156 [6.35 x 3.96] Dia.

60VK6



Typical Dimensions:
 Terminals (5): 1/4-20, Torque 56 lbf-in. [6.32 N-m] max. ± 2 [.22]
 Mounting Slots (4): .250 x .156 [6.35 x 3.96] Dia.

K7 & K7M (3, 5, 10A)



Typical Dimensions:
 Load Terminals (2): .250 [6.3] with .07 [1.8] Dia. hole
 Ground Terminal (1): .250 [6.3] with .07 x .16 [1.8 x 3.8] slot
 Line Inlet (1): IEC 60320-1 C14
 K7 Tapped Inserts (2): 6-32 x 1/4
 K7M Tapped Inserts (2): M3 x .5

20VK7



Typical Dimensions:
 Load Terminals (2): .250 [6.3] with .07 [1.8] Dia. hole
 Ground Terminal (1): .250 [6.3] with .07 x .16 [1.8 x 3.8] slot
 Line Inlet (1): IEC 60320-1 C20
 K7 Tapped Inserts (2): 6-32 x 1/4
 K7M Tapped Inserts (2): M3 x .5



RFI Power Line Filters

General Purpose RFI Power Line Filters (continued)

K Series

Case Dimensions

Part No.	A (max)	B (max)	C (max)	D $\pm .015$ $\pm .38$	E (max)
1VK1, 1EK1,	3.1	2.07	0.91	2.375	2.81
2VK1, 2EK1	78.7	52.6	23.1	60.33	74.1
1VK3, 1EK3,	1.81	2.07	0.91	2.375	2.81
2VK3, 2EK3	46.0	52.6	23.1	60.33	74.1
3VK1, 3EK1,	3.10	2.07	1.16	2.375	2.81
5VK1, 5EK1	78.7	52.6	29.5	60.33	74.1
3VK3, 3EK3,	1.81	2.07	1.16	2.375	2.81
5VK5, 5EK3	46.0	52.6	29.5	60.33	74.4
3VK7/7M,	3.21	2.25	1.28	1.575	0.63*
3EK7/7M	81.5	57.2	32.5	40.01	16.0'
5VK7/7M,	3.21	2.25	1.28	1.575	0.63*
5EK7/7M	81.5	57.2	32.5	40.01	16.0'
10VK1,	3.35	2.07	1.16	2.375	2.81
10EK1	85.1	52.6	29.5	60.33	71.4
10VK3,	2.07	2.07	1.16	2.375	2.81
10EK3	52.6	52.6	29.5	60.33	71.4
10VK6	3.46	2.07	1.16	2.375	2.81
	87.9	52.6	29.5	60.33	71.4
10VK7/7M,	3.71	2.25	1.28	1.575	0.63*
10EK7/7M	94.2	57.2	32.5	40.01	16.0'
20VK1,	3.35	2.56	1.53	2.938	3.35
20EK1	85.1	65.0	38.9	74.63	85.1
20VK6	3.46	2.56	1.53	2.938	3.35
	87.9	65.0	38.9	74.63	85.1
20VK7	3.8	2.28	1.78	1.575	.846'
	90.4	54.6	39.6	74.63	85.8'
30VK6,	5.34	3.38	1.53	3.75	4.20
30VK6C	135.6	85.9	38.9	95.25	106.7
40VK6,	5.34	3.38	1.53	3.75	4.20
40VK6C	135.6	85.9	38.9	95.25	106.7
60VK6	6.0	3.38	1.53	3.75	4.20
	152.4	85.9	38.9	95.25	106.7

*±0.02 [0.5]
'±0.01 [0.25]

Recommended Panel Cutouts

K7 & K7M Cutout (3, 5, 10A)



20VK7 Cutout



Performance Data

Typical Insertion Loss

Measured in closed 50 Ohm system

1 & 3EK



2 & 10EK



5EK



20EK



General Purpose RFI Power Line Filters (continued)

K Series

Performance Data (continued)

Typical Insertion Loss

Measured in closed 50 Ohm system

1VK

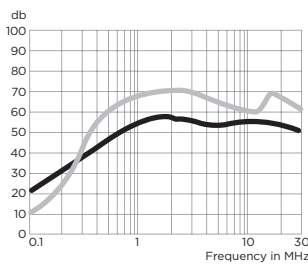

2VK

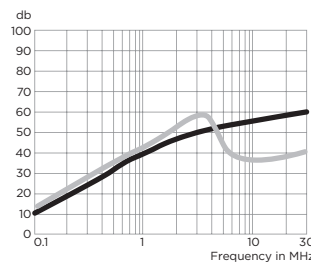

3VK

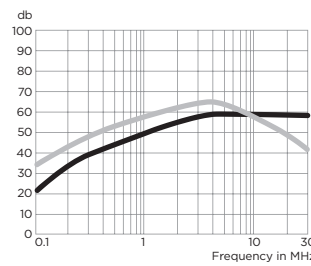

5VK

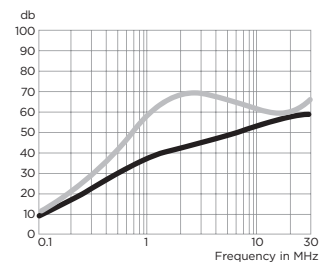

10VK



20VK



30VK & 30VK6C



40VK & 40VK6C

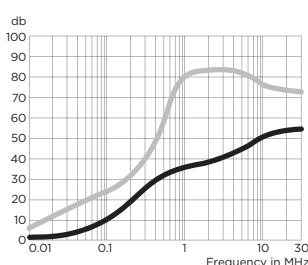

60VK

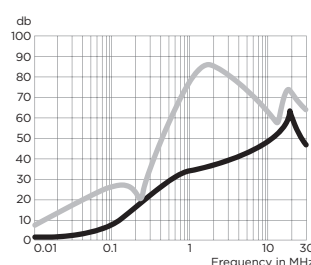

— Common Mode / Asymmetrical (L-G)
— Differential Mode / Symmetrical (L-L)

Minimum Insertion Loss

Measured in closed 50 Ohm system

Common Mode / Asymmetrical (Line to Ground)

Current Rating	Frequency – MHz					
	.15	.5	1	5	10	30
VK Models						
1A, 3A	15	30	38	50	50	50
2A, 5A, 10A	6	19	28	42	45	50
20A	6	19	28	42	45	50
30A, 40A	6	19	28	42	45	50
60A	6	22	28	32	39	35
EK Models						
1A, 3A	15	29	35	45	45	50
2A, 5A, 10A	8	19	25	38	40	45
20A	8	19	25	38	40	45

Differential Mode / Symmetrical (Line to Line)

Current Rating	Frequency – MHz					
	.15	.5	1	5	10	30
VK Models						
1A, 3A	-	-	48	55	50	35
2A, 5A, 10A	-	-	30	50	30	30
20A	6	6	30	50	30	30
30A, 40A	2	40	60	65	57	55
60A	13	49	67	57	53	53
EK Models						
1A, 3A	-	-	48	55	50	35
2A, 5A, 10A	-	-	30	50	30	30
20A	6	6	30	50	30	30

Multi-purpose Medical Filter for Power Line Noise Protection

MV Series



UL Recognized
CSA Certified
VDE Approved



MV Series

- Multi-purpose medical filter
- Improved Line to Ground performance
- A good solution to emission or immunity problems
- Meets leakage current requirements of UL2601 for health care equipment

Specifications

Maximum leakage current each Line to Ground:
 @ 120 VAC 60 Hz: .07 mA
 @ 250 VAC 50 Hz: .13 mA

Hipot rating (one minute):
 Line to Ground: 2250 VDC
 Line to Line: 1450 VDC

Rated Voltage (max): 250 VAC

Operating Frequency: 50/60 Hz

Rated Current: 3 to 20A

Operating Ambient Temperature Range (at rated current I_r): -10°C to +40°C
 In an ambient temperature (T_a) higher than +40°C the maximum operating current (I_o) is calculated as follows: $I_o = I_r \sqrt{(85-T_a)/45}$

Ordering Information



Electrical Schematic



Available Part Numbers

3MV1	6MV1
10MV1	20MV1

Multi-purpose Medical Filter for Power Line Noise Protection *(continued)*

MV Series

Case Styles

MV1 (3, 6, 10A)

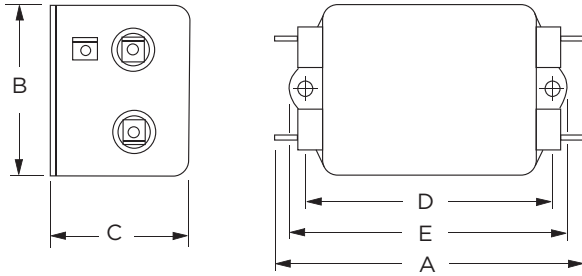

Typical Dimensions:

- Line/Load Terminals (4): .250 [6.3] with .07 [1.8] Dia. hole
- Ground Terminal (1): .250 [6.3] with .07 x .16 [1.8 x 3.8] slot
- Mounting Holes (2): .188 [4.78] Dia.

20MV1

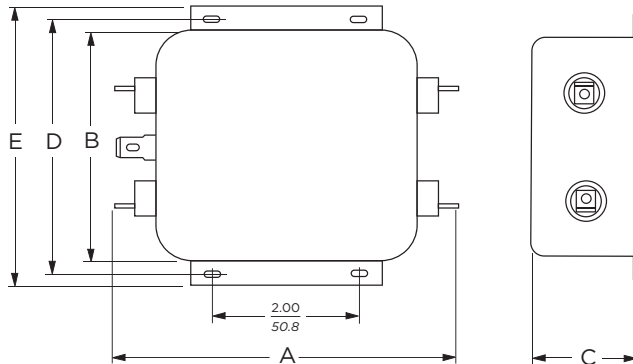

Typical Dimensions:

- Line/Load Terminals (4): .250 [6.3] with .07 [1.8] Dia. hole
- Ground Terminal (1): .250 [6.3] with .07 x .16 [1.8 x 3.8] slot
- Mounting Holes (2): .188 [4.78] Dia.

Case Dimensions

Part No.	A (max)	B (max)	C (max)	D $\pm .015$ $\pm .38$	E (max)
3MV1	3.36 85.3	1.82 46.2	1.28 32.5	2.375 60.33	2.78 70.6
6MV1	3.86 98.0	2.08 52.8	1.53 38.9	2.938 74.63	3.34 84.8
10MV1	3.86 98.0	2.08 52.8	1.53 38.9	2.938 74.63	3.34 84.8
20MV1	5.23 132.8	3.38 85.9	1.53 38.9	3.75 95.25	4.20 106.7

Performance Data

Typical Insertion Loss

Measured in closed 50 Ohm system

3MV

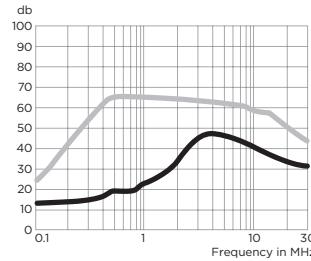

6MV

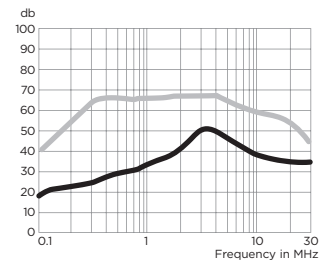

10MV

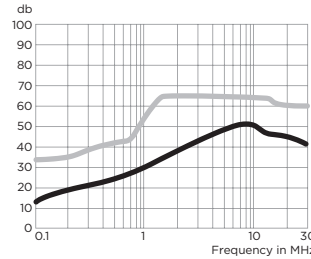

20MV

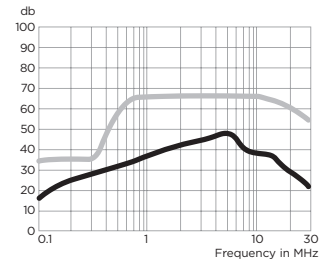

— Common Mode / Asymmetrical (L-G)
- - - Differential Mode / Symmetrical (L-L)

Minimum Insertion Loss

Measured in closed 50 Ohm system

Common Mode / Asymmetrical (Line to Ground)

Current Rating	Frequency – MHz							
	.15	.5	1	2	5	10	20	30
3A	14	19	20	30	46	40	34	31
6A	19	27	30	38	50	40	35	35
10A	15	25	26	34	46	50	44	42
20A	18	30	34	34	46	40	36	20

Differential Mode / Symmetrical (Line to Line)

Current Rating	Frequency – MHz							
	.15	.5	1	2	5	10	20	30
3A	33	65	65	65	65	60	53	50
6A	40	65	65	65	65	60	57	55
10A	33	65	65	65	65	65	55	55
20A	25	65	65	65	65	60	57	45



RFI Power Line Filters

High Performance RFI Filters for Switching Power Supplies

N Series



UL Recognized
CSA Certified
VDE Approved



N Series

- Superior attenuation for most digital electronic equipment over the frequency range of 10kHz to 30MHz
- Provides excellent common mode and differential mode performance
- Cost-effective solution to very noisy equipment that must meet conducted emission limits

Ordering Information



Available Part Numbers

6VN1	10VN1
------	-------

Specifications

Maximum leakage current each Line to Ground:
 @ 120 VAC 60 Hz: 1.2 mA
 @ 250 VAC 50 Hz: 2.0 mA

Hipot rating (one minute):
 Line to Ground: 2250 VDC
 Line to Line: 1450 VDC

Rated Voltage (max): 250 VAC

Operating Frequency: 50/60 Hz

Rated Current: 6 to 10A

Operating Ambient Temperature Range (at rated current I_r): -10°C to +40°C
 In an ambient temperature (T_a) higher than +40°C the maximum operating current (I_o) is calculated as follows: $I_o = I_r \sqrt{(85-T_a)/45}$

Electrical Schematics

3VN



10VN



High Performance RFI Filters for Switching Power Supplies *(continued)*

N Series

Case Styles



Typical Dimensions:

- Line/Load Terminals (4): 250 [6.3] with .07 [1.8] Dia. hole
- Ground Terminal (1): 250 [6.3] with .07 x .16 [1.8 x 3.8] slot
- Mounting Holes (2): .188 [4.78] Dia.

Case Dimensions

Part No.	A (max)	B (max)	C (max)	D $\pm .015$ $\pm .38$	E (max)
6VN1	<i>3.56</i>	<i>2.15</i>	<i>1.81</i>	<i>2.938</i>	<i>3.38</i>
	<i>90.4</i>	<i>54.6</i>	<i>45.9</i>	<i>74.63</i>	<i>85.8</i>
10VN1	<i>4.69</i>	<i>2.27</i>	<i>1.8</i>	<i>4.063</i>	<i>4.47</i>
	<i>119.1</i>	<i>57.7</i>	<i>45.7</i>	<i>103.2</i>	<i>113.5</i>

Performance Data

Typical Insertion Loss

Measured in closed 50 Ohm system

6VN



10VN



— Common Mode / Asymmetrical (L-G)
- - - Differential Mode / Symmetrical (L-L)

Minimum Insertion Loss

Measured in closed 50 Ohm system

Common Mode / Asymmetrical (Line to Ground)

Current Rating	Frequency – MHz								
	.01	.05	.1	.15	.5	1	5	10	30
6A	6	20	28	34	58	54	53	53	43
10A	8	8	44	55	75	70	70	70	55

Differential Mode / Symmetrical (Line to Line)

Current Rating	Frequency – MHz								
	.01	.05	.1	.15	.5	1	5	10	30
6A	6	14	41	52	66	77	72	60	60
10A	6	6	35	45	72	70	72	75	70

Highest Performance RFI Filters for Switching Power Supplies

Q Series



UL Recognized
CSA Certified
VDE Approved



Q Series

- Specifically developed for switching power supplies
- High attenuation for common and differential mode interference
- Effective from 10kHz to 30MHz
- Optimized for attenuation and size
- 3 or 6A versions available with IEC inlet

Ordering Information



*IEC 60320-1 C14 inlet mates with C13 connector

Specifications

Maximum leakage current each Line to Ground:

	VQ Models	EQ Models
3 & 20A		
@120 VAC 60 Hz:	.73 mA	.22 mA
@250 VAC 50 Hz:	1.27 mA	.38 mA
6A		
@120 VAC 60 Hz:	—	.29 mA
@250 VAC 50 Hz:	—	.51 mA

Hipot rating (one minute):

Line to Ground:	2250 VDC
Line to Line:	1450 VDC

Rated Voltage (max): 250 VAC

Operating Frequency: 50/60 Hz

Rated Current: 3 to 20A

Operating Ambient Temperature Range

(at rated current I_r): -10°C to +40°C
In an ambient temperature (T_a) higher than +40°C the maximum operating current (I_o) is calculated as follows: $I_o = I_r \sqrt{(85-T_a)/45}$

Available Part Numbers

3EQ1	6EQ8M
3EQ3	20EQ1
3EQ8	3VQ1
3EQ8M	3VQ3
6EQ1	3VQ8
6EQ3	3VQ8M
6EQ8	20VQ1

Accessories

GA400: NEMA 5-15P to IEC 60320-1 C-13 line cord



Highest Performance RFI Filters for Switching Power Supplies *(continued)*

Q Series

Electrical Schematics

3A



6, 20A



Case Styles

Q1



Typical Dimensions:

- Line/Load Terminals (4): .250 [6.3] with .07 [1.8] Dia. hole
- Ground Terminal (1): .250 [6.3] with .07 x .16 [1.8 x 3.8] slot
- Mounting Holes (2): .188 [4.78] Dia.

Q3



Typical Dimensions:

- Wire Leads (5): 4.0 [101.6] Min., 18AWG
- Mounting Holes (2): .188 [4.78] Dia.

Q8, Q8M (3A)



Typical Dimensions:

- Wire Leads (3): 6.0 [152.4] Min., 18AWG
- Line Inlet (1): IEC 60320-1 C14
- Q8 Tapped Inserts (2): 6-32 x 1/4
- Q8M Tapped Inserts (2): M3 x .5

Q8, Q8M (6A)



Typical Dimensions:

- Wire Leads (3): 6.0 [152.4] Min., 18AWG
- Line Inlet (1): IEC 60320-1 C14
- Q8 Tapped Inserts (3): 6-32 x 1/4
- Q8M Tapped Inserts (3): M3 x .5

Case Dimensions

Part No.	A (max)	B (max)	C (max)	D ±.015 ±.38	E (max)
3VQ1, 3EQ1	3.85	2.07	1.78	2.938	3.34
	97.8	52.6	45.2	74.63	84.8
3VQ3, 3EQ3	2.56	2.07	1.78	2.938	3.34
	65.0	52.6	45.2	74.63	84.8
3VQ8/8M, 3EQ8/8M	3.07	2.25	1.78	1.575	0.63*
	78.0	57.2	45.2	40.01	16.0*
6EQ1	4.98	2.27	1.80	4.063	4.47
	126.5	57.7	45.7	103.2	113.5
6EQ3	3.69	2.27	1.80	4.063	4.47
	93.7	57.7	45.7	103.2	113.5
6EQ8/8M	5.47	2.07	1.78	1.575	2.70
	138.9	52.6	45.2	40.01	68.0
20EQ1, 20VQ1	6.66	2.07	2.28	5.625	6.03*
	168.1	52.6	57.9	142.9	153.2*

*±0.02 [0.5]

Highest Performance RFI Filters for Switching Power Supplies *(continued)*

Q Series

Recommended Panel Cutout



Tolerance $\pm .005$ [0.13]

Performance Data

Typical Insertion Loss

Measured in closed 50 Ohm system

3VQ



3EQ



6EQ



20VQ



20EQ



— Common Mode / Asymmetrical (L-G)
— Differential Mode / Symmetrical (L-L)

Minimum Insertion Loss

Common Mode / Asymmetrical (Line to Ground)

Current Rating	Frequency – MHz								
	.01	.02	.05	.15	.5	1	5	10	30
3VQ	22	27	37	50	55	55	55	50	55
3EQ	22	27	36	47	47	43	45	45	45
6EQ	26	31	20	68	72	72	65	65	65
20EQ	6	10	8	39	60	65	65	65	55
20VQ	6	3	17	52	65	70	70	70	70

Differential Mode / Symmetrical (Line to Line)

Current Rating	Frequency – MHz								
	.01	.02	.05	.15	.5	1	5	10	30
3VQ	1	17	42	65	75	75	60	65	65
3EQ	1	17	42	65	75	75	65	65	60
6EQ	6	10	43	70	75	75	65	55	55
20EQ	15	20	20	46	65	70	65	60	60
20VQ	15	20	20	46	65	70	65	60	60

Two-stage General Purpose RFI Power Line Filter

R Series



UL Recognized
CSA Certified
VDE Approved



R Series

- Dual T section RFI filter provides premium performance
- Well suited for low impedance loads where noisy RFI environments are present
- Controls pulsed, continuous and/or intermittent interference
- ER models offer low leakage current without deterioration of insertion loss

Ordering Information



*IEC 60320-1 C14 inlet mates with C13 connector

Specifications

Maximum leakage current each Line to Ground:

	VR Models	ER Models
@120 VAC 60 Hz:	.4 mA	.21 mA
@250 VAC 50 Hz:	.7 mA	.36 mA

Hipot rating (one minute):

Line to Ground:	2250 VDC
Line to Line:	1450 VDC

Rated Voltage (max): 250 VAC

Operating Frequency: 50/60 Hz

Rated Current: 1 to 20A

Operating Ambient Temperature Range

(at rated current I_r): -10°C to +40°C
In an ambient temperature (T_a) higher than +40°C the maximum operating current (I_o) is calculated as follows: $I_o = I_r \sqrt{(85-T_a)/45}$

Available Part Numbers

1VR1	1ER1
1VR3	1ER3
2VR1	2ER1
2VR3	2ER3
3VR1	3ER1
3VR3	3ER3
3VR7	3ER7
3VR7M	3ER7M
5VR1	5ER1
5VR3	5ER3
5VR7	5ER7
5VR7M	5ER7M
10VR1	10ER1
10VR3	10ER3
10VR6	10ER7
10VR7	10ER7M
10VR7M	20ER1
20VR1	
20VR6	

Two-stage General Purpose RFI Power Line Filter *(continued)*

R Series

Electrical Schematic



Case Styles

R1 (1, 2, 3, 5, 10A)



Typical Dimensions:
 Line/Load Terminals (4): .250 [6.3] with .07 [1.8] Dia. hole
 Ground Terminal (1): .250 [6.3] with .07 x .16 [1.8 x 3.8] slot
 Mounting Holes (2): .188 [4.78] Dia.

R1 (20A)



Typical Dimensions:
 Line/Load Terminals (4): .250 [6.3] with .07 [1.8] Dia. hole
 Ground Terminal (1): .250 [6.3] with .07 x .16 [1.8 x 3.8] slot
 Mounting Slots (4): .250 x .156 [6.35 x 3.96] Dia.

Case Styles *(continued)*

R3



Typical Dimensions:
 Wire Leads (5): 4.0 [101.6] Min., AWG18
 Mounting Holes (2): .188 [4.78] Dia.

10VR6



Typical Dimensions:
 Terminals (5): 8-32, Torque 18 lbf-in. [2.03 N-m] max. ± 2 [.22]
 Mounting Holes (2): .188 [4.78] Dia.

20VR6

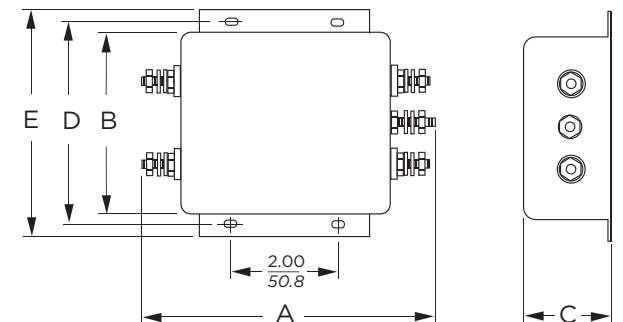

Typical Dimensions:
 Terminals (5): 8-32, Torque 18 lbf-in. [2.03 N-m] max. ± 2 [.22]
 Mounting Slots (4): .250 x .156 [6.35 x 3.96] Dia.

Two-stage General Purpose RFI Power Line Filter *(continued)*

R Series

Case Styles *(continued)*

R7 & R7M



Typical Dimensions:

- Load Terminals (2): .250 [6.3] with .07 [1.8] Dia. hole
- Ground Terminal (1): .250 [6.3] with .07 x .16 [1.8 x 3.8] slot
- Line Inlet (1): IEC 60320-1 C14
- K7 Tapped Inserts (2): 6-32 x 1/4
- K7M Tapped Inserts (2): M3 x .5

Recommended Panel Cutout

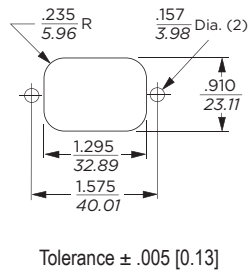

Accessories

GA400: NEMA 5-15P to IEC 60320-1 C-13 line cord



Case Dimensions

Part No.	A (max)	B (max)	C (max)	D $\pm .015$ $\pm .38$	E (max)
1VR1, 1ER1,	3.35	1.81	1.16	2.375	2.78
2VR1, 2ER1	<i>85.1</i>	<i>46.0</i>	<i>29.5</i>	<i>60.33</i>	<i>70.6</i>
1VR3, 1ER1,	2.07	1.81	1.16	2.375	2.78
2VR3, 2ER3	<i>52.6</i>	<i>46.0</i>	<i>29.5</i>	<i>60.33</i>	<i>70.6</i>
3VR1, 3ER1,	3.85	2.07	1.16	2.938	3.35
5VR1, 5ER1	<i>97.8</i>	<i>52.6</i>	<i>29.5</i>	<i>74.63</i>	<i>85.1</i>
3VR3, 3ER3,	2.56	2.07	1.16	2.938	3.35
5VR3, 5ER3	<i>65.0</i>	<i>52.6</i>	<i>29.5</i>	<i>74.63</i>	<i>85.1</i>
3VR7/7M,	4.33	2.25	1.28	1.575	0.64*
3ER7/7M	<i>110.0</i>	<i>57.2</i>	<i>32.5</i>	<i>40.01</i>	<i>16.3*</i>
5VR7/7M,	4.33	2.25	1.28	1.575	0.64*
5ER7/7M	<i>110.0</i>	<i>57.2</i>	<i>32.5</i>	<i>40.01</i>	<i>16.3*</i>
10VR1,	3.85	2.07	1.53	2.938	3.35
10ER1	<i>97.8</i>	<i>52.6</i>	<i>38.9</i>	<i>74.63</i>	<i>85.1</i>
10VR3,	2.56	2.07	1.53	2.938	3.35
10ER3	<i>65.0</i>	<i>52.6</i>	<i>38.9</i>	<i>74.63</i>	<i>85.1</i>
10VR6	3.96	2.07	1.53	2.938	3.35
	<i>100.6</i>	<i>52.6</i>	<i>38.9</i>	<i>74.63</i>	<i>85.1</i>
10VR7/7M,	4.33	2.25	1.53	1.575	0.88*
10ER7/7M	<i>110.0</i>	<i>57.2</i>	<i>38.9</i>	<i>40.01</i>	<i>22.4*</i>
20VR1,	5.23	3.37	1.53	3.75	4.20
20ER1	<i>132.8</i>	<i>85.6</i>	<i>38.9</i>	<i>95.25</i>	<i>106.7</i>
20VR6	5.34	3.37	1.53	3.75	4.20
	<i>135.6</i>	<i>85.6</i>	<i>38.9</i>	<i>95.25</i>	<i>406.7</i>

*±0.02 [0.5]

Two-stage General Purpose RFI Power Line Filter *(continued)*

R Series

Performance Data

Typical Insertion Loss

Measured in closed 50 Ohm system

1ER



3ER



5ER



2ER, 10ER & 20ER



1VR



2VR



3VR



5VR



10VR



20VR



— Common Mode / Asymmetrical (L-G)
— Differential Mode / Symmetrical (L-L)

Minimum Insertion Loss

Measured in closed 50 Ohm system

Common Mode / Asymmetrical (Line to Ground)

Current Rating	Frequency – MHz					
	.15	.5	1	5	10	30
VR Models						
1A, 3A	30	65	65	65	65	65
2A, 5A, 10A, 20A	5	44	60	65	65	60
ER Models						
1A, 3A	25	60	65	65	65	65
2A, 5A, 10A, 20A	2	35	51	63	60	50

Differential Mode / Symmetrical (Line to Line)

Current Rating	Frequency – MHz					
	.15	.5	1	5	10	30
VR Models						
1A, 3A	-	-	65	60	54	46
2A, 5A, 10A, 20A	-	-	35	60	57	45
ER Models						
1A, 3A	-	-	65	60	54	46
2A, 5A, 10A, 20A	-	-	35	60	57	45

High Performance Compact Power Line Filter

RK Series



UL Recognized
CSA Certified
VDE Approved



RK Series

- Compact
- Single stage
- Chassis mount
- Significant differential mode performance
- Suitable for industrial machinery
- Low input leakage current makes it suitable for portable equipment

Ordering Information



Available Part Numbers

3ERK1	6ERK1
10ERK1	15ERK1
20ERK1	

Specifications

Maximum leakage current each Line to Ground:

@ 120 VAC 60 Hz:	0.16 mA
@250 VAC 50 Hz:	0.26 mA

Hipot rating (one minute):

Line to Ground:	2250 VDC
Line to Line:	1450 VDC

Rated Voltage (max):

250 VAC

Operating Frequency:

50/60 Hz

Rated Current:

3 to 20A

Operating Ambient Temperature Range

(at rated current I_r): -10°C to +40°C

In an ambient temperature (T_a) higher than +40°C the maximum operating current (I_o) is calculated as follows: $I_o = I_r \sqrt{(85-T_a)/45}$

Electrical Schematic

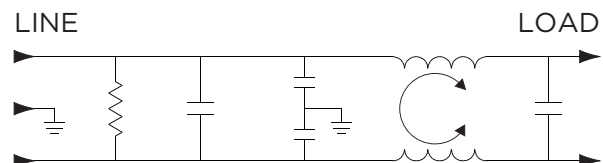

1

RFI Power Line Filters

High Performance Compact Power Line Filter *(continued)*

RK Series

Case Styles

RK1 (3 & 6A)



RK1 (10, 15 & 20A)



Typical Dimensions:

- Line/Load Terminals (4): .250 [6.3] with .07 [1.8] Dia. hole
- Ground Terminal (1): .250 [6.3] with .07 x .16 [1.8 x 3.8] slot
- Mounting Holes (2): .188 [4.78] Dia.

Case Dimensions

Part No.	A (max)	B (max)	C (max)	D $\pm .015$ $\pm .38$	E (max)
3ERK1	3.35 <i>85.09</i>	1.82 <i>46.23</i>	1.16 <i>29.46</i>	2.38 <i>74.68</i>	2.78 <i>70.61</i>
6ERK1	3.35 <i>85.09</i>	1.82 <i>46.23</i>	1.28 <i>32.51</i>	2.38 <i>74.68</i>	2.78 <i>70.61</i>
10ERK1, 15ERK1, 20ERK1	3.85 <i>97.79</i>	2.07 <i>52.58</i>	1.78 <i>45.21</i>	2.94 <i>74.67</i>	3.35 <i>85.09</i>

High Performance Compact Power Line Filter *(continued)*

RK Series

Performance Data

Typical Insertion Loss

Measured in closed 50 Ohm system

3RK



6RK



10RK



15RK



20RK



— Common Mode / Asymmetrical (L-G)
— Differential Mode / Symmetrical (L-L)

Minimum Insertion Loss

Common Mode / Asymmetrical (Line to Ground)

Current Rating	Frequency – MHz									
	.05	.10	.15	.5	1	2	5	10	20	30
3A	21	27	30	43	49	50	50	48	50	49
6A	19	29	29	37	43	44	48	46	50	48
10A	20	27	31	45	45	44	46	47	53	44
15A	21	28	31	45	43	41	42	42	47	57
20A	19	25	29	34	36	38	40	41	43	52

Differential Mode / Symmetrical (Line to Line)

Current Rating	Frequency – MHz									
	.05	.10	.15	.5	1	2	5	10	20	30
3A	9	20	35	67	78	78	72	66	61	60
6A	14	14	13	59	74	80	72	68	61	60
10A	14	12	30	65	80	84	78	70	60	50
15A	15	13	20	61	76	88	70	72	64	50
20A	16	19	16	54	74	90	74	67	61	54

Multipurpose Power Line RFI Filter for Emission Control

S Series



UL Recognized
CSA Certified
VDE Approved



20VS1



3VS1

S Series

- Combines Line to Ground interference rejection filters with additional circuitry to reduce Line to Line noise and transients
- Designed for use when equipment impedance at RF frequencies is high
- Effective for use with switch-mode power supplies
- Effective when used to control emissions in equipment using SCR and T2L circuits for compliance with FCC Part 15, Subpart J and EN55022, Level A, down to 150kHz

Ordering Information



Available Part Numbers

3VS1	20VS1
6VS1	20VS6
10VS1	60VS6

Specifications

Maximum leakage current each Line to Ground:

	<u>3 & 20A</u>	<u>60A</u>
@120 VAC 60 Hz:	.4 mA	.75 mA
@250 VAC 50 Hz:	.7 mA	1.25 mA

Hipot rating (one minute):

Line to Ground:	2250 VDC
Line to Line:	1450 VDC

Rated Voltage (max):

250 VAC

Operating Frequency:

50/60 Hz

Rated Current:

3 to 60A

Operating Ambient Temperature Range

(at rated current I_r): -10°C to +40°C

In an ambient temperature (T_a) higher than +40°C the maximum operating current (I_o) is calculated as follows: $I_o = I_r \sqrt{(85-T_a)/45}$

Electrical Schematics

3, 6, 10VS



20VS



60VS

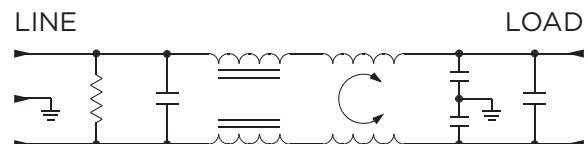

Multipurpose Power Line RFI Filter for Emission Control *(continued)*

S Series

Case Styles

S1 (3, 6, 10A)



Typical Dimensions:

- Line/Load Terminals (4): .250 [6.3] with .07 [1.8] Dia. hole
- Ground Terminal (1): .250 [6.3] with .07 x .16 [1.8 x 3.8] slot
- Mounting Holes (2): .188 [4.78] Dia.

20VS1



Typical Dimensions:

- Line/Load Terminals (4): .250 [6.3] with .07 [1.8] Dia. hole
- Ground Terminal (1): .250 [6.3] with .07 x .16 [1.8 x 3.8] slot
- Mounting Slots (4): .250 x .156 [6.35 x 3.96] Dia.

20VS6



Typical Dimensions:

- Terminals (5): 8-32, Torque 18 lbf-in. [2.03 N-m] max. ± 2 [.22]
- Mounting Slots (4): .250 x .156 [6.35 x 3.96] Dia.

60VS6



Typical Dimensions:

- Terminals (5): 1/4-20, Torque 56 lbf-in. [6.32 N-m] max. ± 2 [.22]
- Mounting Holes (5): .218 [5.53] Dia. ± .006 [.152]

Case Dimensions

Part No.	A (max)	B (max)	C (max)	D $\pm .015$ $\pm .38$	E (max)
3VS1	3.36 85.3	1.82 46.2	1.16 29.5	2.375 60.33	2.78 70.6
6VS1	3.86 98.0	2.08 52.8	1.53 38.9	2.938 74.63	3.34 84.8
10VS1	3.86 98.0	2.08 52.8	1.53 38.9	2.938 74.63	3.34 84.8
20VS1	5.23 132.8	3.38 85.9	1.53 38.9	3.75 95.25	4.20 106.7
20VS6	5.34 135.6	3.38 85.9	1.53 38.9	3.75 95.25	4.20 106.7
60VS6	7.2 182.88	3.08 78.23	2.28 57.91	5.625 142.87	6.25 158.75



RFI Power Line Filters

Multipurpose Power Line RFI Filter for Emission Control *(continued)*

S Series

Performance Data

Typical Insertion Loss

Measured in closed 50 Ohm system

3VS



6VS



10VS



20VS



60VS



— Common Mode / Asymmetrical (L-G)
— Differential Mode / Symmetrical (L-L)

Minimum Insertion Loss

Measured in closed 50 Ohm system

Common Mode / Asymmetrical (Line to Ground)

Current Rating	Frequency – MHz							
	.15	.5	1	2	5	10	20	30
3A	15	27	35	40	32	44	47	47
6A	15	27	35	40	32	44	47	47
10A	15	27	35	40	32	44	47	47
20A	15	30	38	38	32	43	42	40
60A	7	27	34	38	45	54	44	40

Differential Mode / Symmetrical (Line to Line)

Current Rating	Frequency – MHz								
	.15	.3	.5	1	2	5	10	20	30
3A	35	50	65	65	65	60	50	40	45
6A	35	50	65	65	65	60	45	48	48
10A	35	50	65	65	65	60	50	40	45
20A	35	50	65	65	65	60	45	48	48
60A	37	-	77	93	86	70	54	64	54

High Performance B Series RFI Line Filters

SB Series



UL Recognized
CSA Certified
VDE Approved



SB Series

- Enhanced performance version of our popular B Series of RFI line filters
- Small size with enhanced performance
- 30A version half the size of other 30A filters
- Low leakage version available that meets current requirements of VDE portable equipment and non-patient care medical equipment

Ordering Information



Electrical Schematic



Specifications

Maximum leakage current each Line to Ground:

	VSB Models	ESB Models
@ 120 VAC 60 Hz:	.75 mA	.22 mA
@ 250 VAC 50 Hz:	1.25 mA	.36 mA

Hipot rating (one minute):

Line to Ground:	2250 VDC
Line to Line:	1450 VDC

Rated Voltage (max):

250 VAC
250 VDC

Operating Frequency:

50/60 Hz

Rated Current:

6 to 30A

Operating Ambient Temperature Range

(at rated current I_r): -10°C to +40°C
In an ambient temperature (T_a) higher than +40°C the maximum operating current (I_o) is calculated as follows: $I_o = I_r \sqrt{(85-T_a)/45}$

Available Part Numbers

6ESB1	6VSB1
10ESB1	10VSB1
10ESB6	10VSB6
20ESB1	20VSB1
20ESB6	20VSB6
30ESB6	30VSB6

High Performance B Series RFI Line Filters *(continued)*

SB Series

Case Styles

6ESB1 & 6VSB1



Typical Dimensions:

- Line/Load Terminals (4): .250 [6.3] with .07 [1.8] Dia. hole
- Ground Terminal (1): .250 [6.3] with .07 x .16 [1.8 x 3.8] slot
- Mounting Holes (2): .188 [4.75] Dia.

10ESB1, 10VSB1, 20ESB1 & 20VSB1



Typical Dimensions:

- Line/Load Terminals (4): .250 [6.3] with .07 [1.8] Dia. hole
- Ground Terminal (1): .250 [6.3] with .07 x .16 [1.8 x 3.8] slot
- Mounting Holes (2): .188 [4.75] Dia.

ESB6 & VSB6

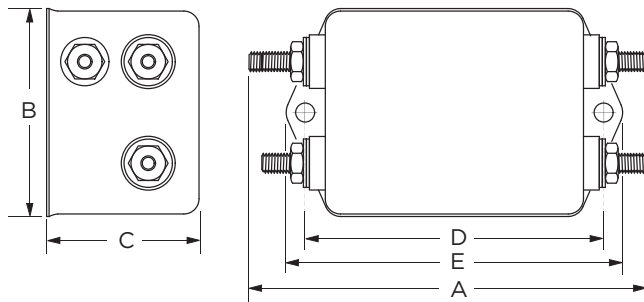

Typical Dimensions:

- Terminals (5): 8-32, Torque 18 lbf-in. [2.03 N-m] max. ± 2 [22]
- Mounting Holes (2): .188 [4.75] Dia.

Case Dimensions

Part No.	A (max)	B (max)	C (max)	D $\pm .015$ $\pm .38$	E (max)
6ESB1,	3.36	1.82	0.91	2.375	2.78
6VSB1	<i>85.34</i>	<i>46.23</i>	<i>23.11</i>	<i>60.325</i>	<i>70.61</i>
10ESB1,	3.36	1.82	1.28	2.375	2.78
10VSB1	<i>85.34</i>	<i>46.23</i>	<i>32.51</i>	<i>60.325</i>	<i>70.61</i>
10ESB6,	3.47	1.82	1.53	2.375	2.78
10VSB6	<i>88.14</i>	<i>46.23</i>	<i>38.86</i>	<i>60.325</i>	<i>70.61</i>
20ESB1,	3.85	2.07	1.31	2.938	3.35
20VSB1	<i>97.79</i>	<i>52.58</i>	<i>33.27</i>	<i>74.625</i>	<i>85.09</i>
20ESB6,	4.00	2.07	1.53	2.938	3.35
20VSB6	<i>101.60</i>	<i>52.58</i>	<i>38.86</i>	<i>74.625</i>	<i>85.09</i>
30ESB6,	4.92	2.07	1.53	3.947	4.33
30VSB6	<i>124.97</i>	<i>52.58</i>	<i>38.86</i>	<i>100.254</i>	<i>109.98</i>

High Performance B Series RFI Line Filters *(continued)*

SB Series

Performance Data

Typical Insertion Loss

Measured in closed 50 Ohm system

ESB Models

6ESB1



10ESB1



10ESB6



20ESB1



20ESB6



30ESB6



VSB Models

6VSB1



10VSB1



10VSB6



20VSB1



20VSB6



30VSB6



— Common Mode / Asymmetrical (L-G)
— Differential Mode / Symmetrical (L-L)

High Performance B Series RFI Line Filters *(continued)*

SB Series

Performance Data *(continued)*

Minimum Insertion Loss

Measured in closed 50 Ohm system

Common Mode / Asymmetrical (Line to Ground)

Part No.	Frequency – MHz										
	.03	.05	.1	.15	.5	1	2	5	10	20	30
ESB Models											
6ESB1	3	8	13	17	31	37	40	47	50	58	62
10ESB1	3	9	15	19	31	39	41	44	47	54	51
10ESB6	3	9	14	18	31	39	41	44	47	54	54
20ESB1	3	7	13	15	30	35	37	39	40	46	40
20ESB6	3	7	13	16	30	35	39	40	44	58	46
30ESB6	3	7	13	17	30	34	37	40	42	49	58
VSB Models											
6VSB1	3	8	14	19	37	47	51	58	66	59	49
10VSB1	3	9	15	21	41	49	50	56	64	54	46
10VSB6	4	9	15	21	39	49	50	56	64	54	44
20VSB1	3	7	14	19	37	45	47	50	60	48	40
20VSB6	3	7	14	19	37	44	49	52	62	48	41
30VSB6	3	6	13	18	37	45	49	51	60	50	42

Differential Mode / Symmetrical (Line to Line)

Part No.	Frequency – MHz											
	.01	.03	.05	.1	.15	.5	1	2	5	10	20	30
ESB Models												
6ESB1	5	14	20	25	29	41	49	47	50	60	74	72
10ESB1	5	15	20	26	29	41	47	50	54	64	74	74
10ESB6	5	14	20	25	29	41	47	48	50	60	62	64
20ESB1	5	15	21	26	29	41	45	48	54	63	70	66
20ESB6	5	15	21	26	29	41	44	48	54	63	70	66
30ESB6	5	14	20	25	29	40	46	50	50	58	70	70
VSB Models												
6VSB1	5	14	20	25	29	40	41	57	66	78	56	62
10VSB1	5	15	21	26	29	39	40	60	64	67	67	64
10VSB6	5	14	20	25	29	39	40	60	64	68	70	64
20VSB1	5	15	20	26	29	40	42	60	68	70	70	67
20VSB6	5	15	21	26	29	39	38	58	68	70	70	66
30VSB6	5	15	20	25	29	39	39	56	62	70	70	66

High Performance K Series RFI Line Filters for SMPS Emission Control

SK Series



UL Recognized
CSA Certified
VDE Approved



SK Series

- Designed to reduce conducted noise to acceptable limits for equipment that must comply with FCC / EN specifications
- Utilizes significantly higher element values than the general purpose K Series which makes them better suited for equipment with Line to Ground and Line to Line conducted emissions including those with switching power supplies
- ESK6C and VSK6C incorporate separate ground circuit inductor to isolate the equipment chassis from power line ground at RF frequencies

Ordering Information



*IEC 60320-1 C14 inlet mates with C13 connector

Specifications

Maximum leakage current each Line to Ground:

	VSK Models	ESK Models
3, 6 & 10A		
@120 VAC 60 Hz:	.4 mA	.21 mA
@250 VAC 50 Hz:	.7 mA	.36 mA
20, 30 & 40A		
@120 VAC 60 Hz:	.75 mA	.3 mA
@250 VAC 50 Hz:	1.25 mA	.5 mA

Hipot rating (one minute):

Line to Ground:	2250 VDC
Line to Line:	1450 VDC

Rated Voltage (max):

250 VAC

Operating Frequency:

50/60 Hz

Rated Current:

3 to 40A

Operating Ambient Temperature Range

(at rated current I_r): -10°C to +40°C
In an ambient temperature (T_a) higher than +40°C the maximum operating current (I_o) is calculated as follows: $I_o = I_r \sqrt{(85-T_a)/45}$

Available Part Numbers

3VSK1	3ESK1	20ESK6
3VSK3	3ESK3	20VSK6
3VSK7	3ESK7	30ESK6
3VSK7M	3ESK7M	30ESK6C
6VSK1	6ESK1	30VSK6
6VSK3	6ESK3	30VSK6C
6VSK7	6ESK7	40VSK6
6VSK7M	6ESK7M	
10VSK1	10ESK1	
10VSK3	10ESK3	
10VSK7	10ESK7	
10VSK7M	10ESK7M	

High Performance K Series Filters for SMPS Emission Control *(continued)*

SK Series

Electrical Schematic



Accessories

GA400: NEMA 5-15P to IEC 60320-1 C-13 line cord



Case Styles

SK1

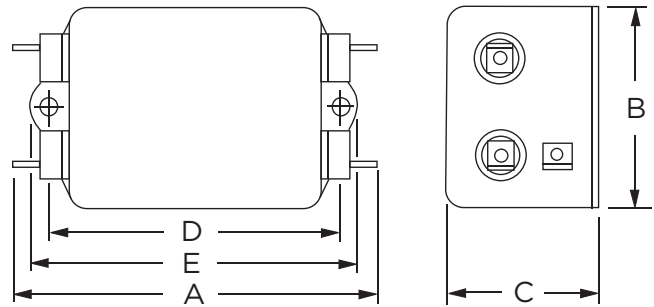

Typical Dimensions:

- Line/Load Terminals (4): .250 [6.3] with .07 [1.8] Dia. hole
- Ground Terminal (1): .250 [6.3] with .07 x .16 [1.8 x 3.8] slot
- Mounting Holes (2): .188 [4.78] Dia.

SK3 (3A)

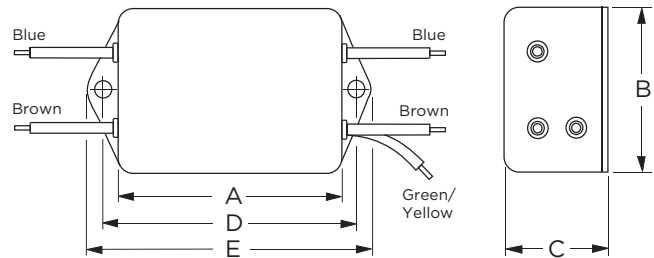

Typical Dimensions:

- Wire Leads (5): 4.0 [101.6] Min., AWG18
- Mounting Holes (2): .188 [4.78] Dia.

SK3 (6 & 10A)

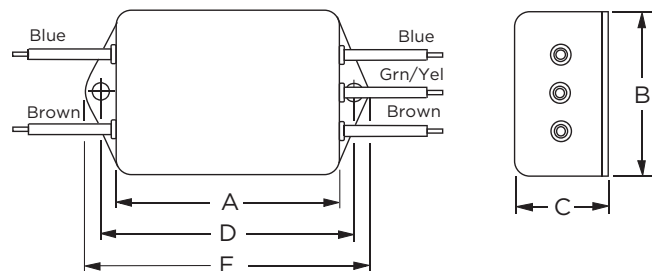

Typical Dimensions:

- Wire Leads (5): 4.0 [101.6] Min., AWG18 (AWG16 for 10A)
- Mounting Holes (2): .188 [4.78] Dia.

High Performance K Series Filters for SMPS Emission Control *(continued)*

SK Series

Case Styles *(continued)*

SK6 (20A)



Typical Dimensions:
 Terminals (5): 8-32, Torque 18 lbf-in. [2.03 N-m] max. ± 2 [.22]
 Mounting Holes (2): .188 [4.78] Dia.

SK6 (30A)



Typical Dimensions:
 Terminals (5): 10-32, Torque 27 lbf-in. [3.05 N-m] max. ± 2 [.22]
 Mounting Slots (4): .250 x .156 [6.35 x 3.96] Dia.

SK6C (30A)



Typical Dimensions:
 Terminals (5): 10-32, Torque 27 lbf-in. [3.05 N-m] max. ± 2 [.22]
 Mounting Slots (4): .250 x .156 [6.35 x 3.96] Dia.

SK6 (40A)



Typical Dimensions:
 Terminals (5): 10-32, Torque 27 lbf-in. [3.05 N-m] max. ± 2 [.22]
 Mounting Slots (4): .203 x .156 [5.15 x 3.96] Dia.

SK7 & SK7M



Typical Dimensions:
 Load Terminals (2): .250 [6.3] with .07 [1.8] Dia. hole
 Ground Terminal (1): .250 [6.3] with .07 x .16 [1.8 x 3.8] slot
 Line Inlet (1): IEC 60320-1 C14
 K7 Tapped Inserts (2): 6-32 x 1/4
 K7M Tapped Inserts (2): M3 x .5

Recommended Panel Cutout



Tolerance ± .005 [0.13]
Back Mount Only



High Performance K Series Filters for SMPS Emission Control *(continued)*

SK Series

Case Dimensions

Part No.	A (max)	B (max)	C (max)	D $\pm .015$ $\pm .38$	E (max)
3VSK1,	3.85	2.07	1.16	2.938	3.35
3ESK1	<i>97.8</i>	<i>52.6</i>	<i>29.5</i>	<i>74.63</i>	<i>85.1</i>
3VSK3,	2.56	2.07	1.16	2.938	3.35
3ESK3	<i>65.0</i>	<i>52.6</i>	<i>29.5</i>	<i>74.63</i>	<i>85.1</i>
3VSK7/7M,	3.21	2.25	1.53	1.575	0.63*
3ESK7/7M	<i>81.5</i>	<i>57.2</i>	<i>38.9</i>	<i>40.01</i>	<i>16.0*</i>
6VSK1,	4.34	2.25	1.28	3.427	3.83
6ESK1	<i>110.2</i>	<i>57.2</i>	<i>32.5</i>	<i>87.05</i>	<i>97.3</i>
6VSK3,	3.05	2.25	1.28	3.427	3.83
6ESK3	<i>77.5</i>	<i>57.2</i>	<i>32.5</i>	<i>87.05</i>	<i>97.3</i>
6VSK7/7M,	3.21	2.25	1.78	1.575	0.63*
6ESK7/7M	<i>81.5</i>	<i>57.2</i>	<i>45.2</i>	<i>40.01</i>	<i>16.0*</i>
10VSK1,	4.97	2.25	1.78	4.063	4.46
10ESK1	<i>126.2</i>	<i>57.2</i>	<i>45.2</i>	<i>103.2</i>	<i>113.3</i>
10VSK3,	3.69	2.25	1.78	4.063	4.46
10ESK3	<i>93.7</i>	<i>57.2</i>	<i>45.2</i>	<i>103.2</i>	<i>113.3</i>
10VSK7/7M,	4.34	2.25	1.78	1.575	0.63*
10ESK7/7M	<i>110.0</i>	<i>57.2</i>	<i>45.2</i>	<i>40.01</i>	<i>16.0*</i>
20VSK6,	5.09	2.25	1.78	4.063	4.46
20ESK6	<i>127.3</i>	<i>57.2</i>	<i>45.2</i>	<i>103.2</i>	<i>129.3</i>
Part No.	A (max)	B (max)	C (max)	D $\pm .020$ $\pm .51$	E (max)
30VSK6,	4.92	3.12	2.75	3.437	4.00
30ESK6	<i>125.0</i>	<i>79.25</i>	<i>69.85</i>	<i>87.3</i>	<i>101.6</i>
30VSK6C,	4.92	3.12	2.75	3.437	4.00
30ESK6C	<i>125.0</i>	<i>79.25</i>	<i>69.85</i>	<i>87.3</i>	<i>101.6</i>
40VSK6	6.45	3.12	2.18	3.50	3.96
	<i>163.83</i>	<i>79.25</i>	<i>55.4</i>	<i>88.9</i>	<i>100.6</i>

*±0.02 [0.5]

Performance Data

Typical Insertion Loss

Measured in closed 50 Ohm system

3 & 6VSK



3 & 6ESK



10 & 20VSK



10 & 20ESK



30VSK



30ESK



40VSK



— Common Mode / Asymmetrical (L-G)
- - - Differential Mode / Symmetrical (L-L)

High Performance K Series Filters for SMPS Emission Control *(continued)*

SK Series

Performance Data *(continued)*

Minimum Insertion Loss

Measured in closed 50 Ohm system

Common Mode / Asymmetrical (Line to Ground)

Current Rating	Frequency – MHz								
	.01	.08	.1	.15	.5	1	5	10	30
VSK Models									
3A, 6A	4	23	25	29	43	44	42	42	30
10A	4	23	25	29	43	44	42	42	30
20A	7	23	25	29	43	44	48	48	48
30A	2	13	14	15	27	31	46	51	39
40A	2	15	18	22	40	43	45	50	30
ESK Models									
3A, 6A	4	22	24	28	42	40	36	36	27
10A	4	22	24	28	42	40	36	36	27
20A	7	22	24	28	35	38	45	45	45
30A	2	13	15	15	27	31	40	41	36

Differential Mode / Symmetrical (Line to Line)

Current Rating	Frequency – MHz								
	.01	.08	.1	.15	.5	1	5	10	30
VSK Models									
3A, 6A	1	3	10	25	59	65	62	40	40
10A	1	3	3	10	55	65	65	50	50
20A	1	10	8	8	45	60	65	60	60
30A	5	13	13	13	60	60	51	43	43
40A	7	14	16	30	65	65	65	57	50
ESK Models									
3A, 6A	1	3	10	25	59	65	62	40	40
10A	1	3	3	10	55	65	65	65	45
20A	1	10	8	8	45	60	65	60	60
30A	5	12	12	13	60	60	51	43	43



High Performance RFI Power Line Filters for Switching Power Supplies

T Series



UL Recognized
CSA Certified
VDE Approved



T Series

- Superior common-mode and premium differential-mode attenuation
- Smaller package sizes than the EP Series
- Size and cost-effective
- ET models can help meet very low leakage current requirements

Ordering Information



*IEC 60320-1 C14 inlet mates with C13 connector

Specifications

Maximum leakage current each Line to Ground:

	ET Models	VT Models
3, 6 & 10A		
@120 VAC 60 Hz:	.30 mA	.75 mA
@250 VAC 50 Hz:	.50 mA	1.2 mA
15 & 20A		
@120 VAC 60 Hz:	.30 mA	1.2 mA
@250 VAC 50 Hz:	.50 mA	2.0 mA

Hipot rating (one minute):

Line to Ground:	2250 VDC
Line to Line:	1450 VDC

Rated Voltage (max): 250 VAC

Operating Frequency: 50/60 Hz

Rated Current: 3 to 20A

Operating Ambient Temperature Range

(at rated current I_r): -10°C to +40°C
In an ambient temperature (T_a) higher than +40°C the maximum operating current (I_o) is calculated as follows: $I_o = I_r \sqrt{(85-T_a)/45}$

Available Part Numbers

3ET1	10ET1	10VT1
3ET3	10ET3	10VT3
3ET7	15ET1	15VT1
6ET1	15ET6	15VT6
6ET3	20ET1	20VT1
6ET7	20ET6	20VT6

High Performance RFI Filters for Switching Power Supplies *(continued)*

T Series

Electrical Schematics

3 & 6A



10A



15 & 20A



Accessories

GA400: NEMA 5-15P to IEC 60320-1 C-13 line cord

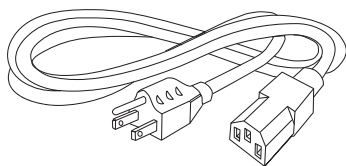

Case Styles

T1 (3, 6, 10A)



Typical Dimensions:

- Line/Load Terminals (4): .250 [6.3] with .07 [1.8] Dia. hole
- Ground Terminal (1): .250 [6.3] with .07 x .16 [1.8 x 3.8] slot
- Mounting Holes (2): .188 [4.78] Dia.

T1 (15 & 20A)



Typical Dimensions:

- Line/Load Terminals (4): .250 [6.3] with .07 [1.8] Dia. hole
- Ground Terminal (1): .250 [6.3] with .07 x .16 [1.8 x 3.8] slot
- Mounting Slots (4): .250 x .156 [6.35 x 3.96] Dia.

T3



Typical Dimensions:

- Wire Leads (5): 4.0 [101.6] Min., AWG18
- Mounting Holes (2): .188 [4.78] Dia.

High Performance RFI Filters for Switching Power Supplies *(continued)*

T Series

Case Styles *(continued)*

T6



Typical Dimensions:
 Terminals (5): 8-32, Torque 18 lbf-in. [2.03 N-m] max. ± 2 [.22]
 Mounting Slots (4): .250 x .156 [6.35 x 3.96] Dia.

T7



Typical Dimensions:
 Load Terminals (2): .250 [6.3] with .07 [1.8] Dia. hole
 Ground Terminal (1): .250 [6.3] with .07 x .16 [1.8 x 3.8] slot
 Line Inlet (1): IEC 60320-1 C14
 Tapped Inserts (2): 6-32 x 1/4

Case Dimensions

Part No.	A (max)	B (max)	C (max)	D $\pm .015$ $\pm .38$	E (max)
3ET1, 6ET1	3.56 90.4	2.15 54.6	1.81 46.0	2.938 74.63	3.38 85.9
3ET3, 6ET3	2.55 64.8	2.15 54.6	1.81 46.0	2.938 74.63	3.38 85.9
3ET7, 6ET7	3.52 89.4	2.25 57.2	1.78 45.2	1.575 40.01	0.63* 16.0*
10ET1, 10VT1	4.69 119.1	2.27 57.7	1.80 45.7	4.063 103.2	4.47 113.5
10ET3, 10VT3	3.69 93.7	2.27 57.7	1.80 45.7	4.063 103.2	4.47 113.5
15ET1, 15VT1, 20ET1, 20VT1	5.45 138.4	3.12 79.2	2.18 55.4	3.5 88.9	3.96 100.6
15ET6, 15VT6, 20ET6, 20VT6	5.95 151.1	3.12 79.2	2.18 55.4	3.5 88.9	3.96 100.6

*±0.02 [0.5]

Recommended Panel Cutout



Tolerance ± .005 [0.13]

High Performance RFI Filters for Switching Power Supplies *(continued)*

T Series

Performance Data

Typical Insertion Loss

Measured in closed 50 Ohm system

— Common Mode / Asymmetrical (L-G)
— Differential Mode / Symmetrical (L-L)

3ET

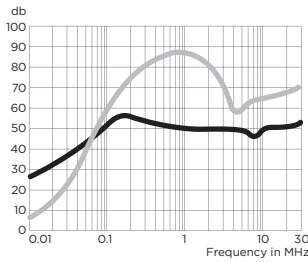

6ET



10ET



15ET



20ET

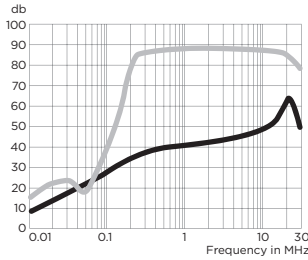

10VT



15VT



20VT

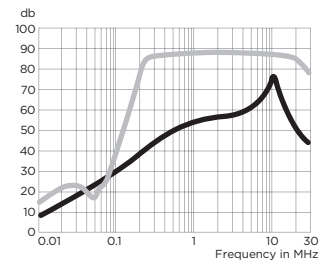

Minimum Insertion Loss

Measured in closed 50 Ohm system

Common Mode / Asymmetrical (Line to Ground)

Current Rating	Frequency – MHz										
	.01	.03	.05	.15	.5	1	2	5	10	20	30
ET Models											
3A	22	32	36	46	47	44	43	40	42	42	42
6A	16	26	30	41	47	44	43	43	40	42	42
10A	12	22	26	36	47	42	42	40	42	42	45
15A	8	17	22	31	43	44	44	42	47	52	43
20A	3	12	17	26	34	36	37	37	42	47	38

Differential Mode / Symmetrical (Line to Line)

Current Rating	Frequency – MHz										
	.01	.03	.05	.15	.5	1	2	5	10	20	30
ET Models											
3A	3	1	30	61	70	70	70	50	50	50	55
6A	4	2	14	51	70	70	70	65	47	50	55
10A	7	12	17	52	70	70	70	65	55	50	60
15A	12	19	15	51	70	70	70	70	70	65	60
20A	10	17	13	51	70	70	70	70	67	65	60

VT Models

10A	12	22	26	38	52	50	50	50	50	50	50
15A	8	17	22	33	52	52	52	52	57	45	35
20A	3	12	17	29	42	47	50	51	55	40	30

VT Models

10A	7	12	17	52	70	70	70	65	65	50	65
15A	12	19	15	51	70	70	70	70	70	65	60
20A	10	17	13	51	70	70	70	70	67	65	60

RFI Filter for Power Factor Corrected Power Supplies

U Series



UL Recognized
CSA Certified
VDE Approved



U Series

- Designed for equipment using power factor corrected power supplies
- Offers high impedance circuit to mismatch the power supply's impedance characteristics
- Available in PC board mountable version
- All models meet low leakage current requirements

Ordering Information



Available Part Numbers

6EUP	6EU1
------	------

Specifications

- Maximum leakage current each Line to Ground:**
 @ 120 VAC 60 Hz: .30 mA
 @ 250 VAC 50 Hz: .50 mA
- Hipot rating (one minute):**
 Line to Ground: 2250 VAC
 Line to Line: 1450 VDC
- Rated Voltage (max):** 250 VAC
- Operating Frequency:** 50/60 Hz
- Rated Current:** 6A
- Operating Ambient Temperature Range (at rated current I_r):** -10°C to +40°C
 In an ambient temperature (T_a) higher than +40°C the maximum operating current (I_o) is calculated as follows: $I_o = I_r \sqrt{(85-T_a)/45}$

Electrical Schematic



RFI Filter for Power Factor Corrected Power Supplies *(continued)*

U Series

Case Styles

6EU1



Typical Dimensions:

- Line/Load Terminals (4): .250 [6.3] with .07 [1.8] Dia. hole
- Ground Terminal (1): .250 [6.3] with .07 x .16 [1.8 x 3.8] slot
- Mounting Holes (2): .188 [4.78] Dia.

6EUP

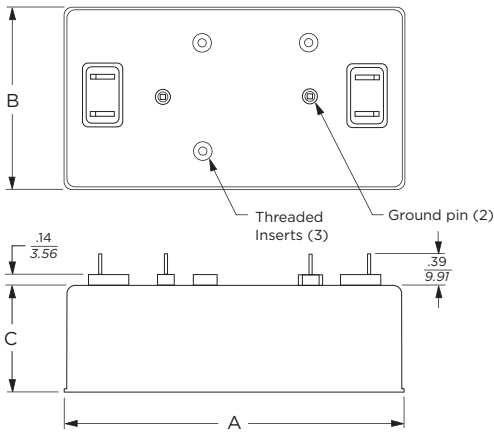

Typical Dimensions:

- Pins (6): 0.065 [1.65] diagonal max.
- Threaded insert(3): 6-32

Recommended PC Board Layout



Case Dimensions

Part No.	A (max)	B (max)	C (max)	D $\pm .015$ $\pm .38$	E (max)
6EU1	4.95 125.73	2.27 57.66	1.80 45.72	4.060 103.12	4.47 113.54
6EUP	4.70 119.4	2.51 66.8	1.22 31.0	-	-

Performance Data

Typical Insertion Loss

Measured in closed 50 Ohm system

6EU



— Common Mode / Asymmetrical (L-G)
— Differential Mode / Symmetrical (L-L)

Minimum Insertion Loss

Common Mode / Asymmetrical (Line to Ground)

Current Rating	Frequency – MHz						
	.05	.1	.15	.5	1	5	10 30
6A	4	30	40	70	70	70	65 50

Differential Mode / Symmetrical (Line to Line)

Current Rating	Frequency – MHz						
	.05	.1	.15	.5	1	5	10 30
6A	10	35	45	70	70	70	65 55

Multipurpose Power Line RFI Filter for Emission Control

V and W Series



UL Recognized
CSA Certified
VDE Approved¹



Both the V and W series are effective to control emissions in equipment using SCR and T²L circuits for compliance with FCC Part 15, Subpart J and EN55022, Level A, down to 150kHz

V Series

- Offers an N = 3 (“T”) Line to Ground impedance to common mode and an N = 5 (“Dbl. Pi”) impedance for Line to Line differential mode interference
- Designed for susceptibility use when equipment impedance at RF frequencies is low

W Series

- Offers an N = 4 (“Dbl. L”) Line to Ground impedance for common mode and an N=5 (“Dbl. Pi”) impedance for Line to Line differential mode interference
- Designed for use when equipment impedance at RF frequencies is high
- Two stage construction provides excellent suppression at high frequencies

Ordering Information



*IEC 60320-1 C20 inlet mates with C19 connector

Specifications

Maximum leakage current each Line to Ground:

@ 120 VAC 60 Hz:	.5 mA
@250 VAC 50 Hz:	.82 mA

Hipot rating (one minute):

Line to Ground:	2250 VDC
Line to Line:	1450 VDC

Rated Voltage (max):

250 VAC

Operating Frequency:

50/60 Hz

Rated Current:

3 to 20A*

Operating Ambient Temperature Range

(at rated current I_r): -10°C to +40°C
In an ambient temperature (T_a) higher than +40°C the maximum operating current (I_o) is calculated as follows: I_o = I_r √(85-T_a)/45

Electrical Schematics

V Series



W Series (3, 6 & 10A)



W Series (20A)

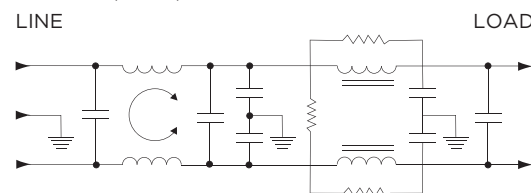

¹20VW7, 20A model tested by Underwriters Laboratories to US and Canadian requirements and is VDE approved at 16A, 250VAC

Multipurpose Power Line RFI Filter for Emission Control (continued)

V and W Series

Available Part Numbers

3VV1	3VW1
6VV1	3VW1
10VV1	10VW1
20VV1	20VW1
20VV6	20VW6
	20VW7*

Case Styles

V1 / W1 (3, 6 & 10A)



Typical Dimensions:
 Line/Load Terminals (4): .250 [6.3] with .07 [1.8] Dia. hole
 Ground Terminal (1): .250 [6.3] with .07 x .16 [1.8 x 3.8] slot
 Mounting Holes (2): .188 [4.78] Dia.

V1 / W1 (20A)

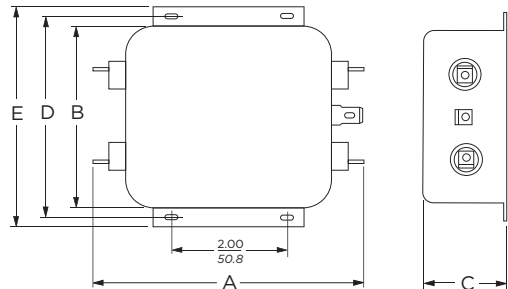

Typical Dimensions:
 Line/Load Terminals (4): .250 [6.3] with .07 [1.8] Dia. hole
 Ground Terminal (1): .250 [6.3] with .07 x .16 [1.8 x 3.8] slot
 Mounting Slots (4): .250 x .156 [6.35 x 3.96] Dia.

V6 / W6

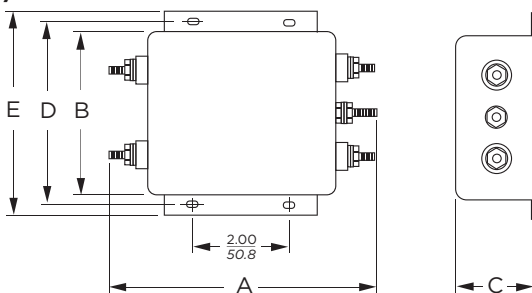

Typical Dimensions:
 Terminals (5): 8-32, Torque 18 lbf-in. [2.03 N-m] max. ± 2 [22]
 Mounting Slots (4): .250 x .156 [6.35 x 3.96] Dia.

Case Styles (continued)

VW7



Typical Dimensions:
 Load Terminals (2): .250 [6.3] with .07 [1.8] Dia. hole
 Ground Terminal (1): .250 [6.3] with .07 x .16 [1.8 x 3.8] slot
 Line Inlet (1): IEC 60320-1 C20
 Tapped Inserts (2): 6-32 x 1/4

Recommended Panel Cutout



Case Dimensions

Part No.	A (max)	B (max)	C (max)	D ±.015 ±.38	E (max)
3VV1, 3VW1	3.36 85.3	1.82 46.2	1.28 32.5	2.375 60.33	2.78 70.6
6VV1, 6VW1	3.86 98.0	2.08 52.8	1.53 38.9	2.938 74.63	3.34 84.8
10VV1, 10VW1	3.86 98.0	2.08 52.8	1.53 38.9	2.938 74.63	3.34 84.8
20VV1, 20VW1	5.23 132.8	3.38 85.9	1.53 38.9	3.75 95.25	4.20 106.7
20VV6, 20VW6	5.34 135.64	3.38 85.9	1.53 38.9	3.76 95.5	4.20 106.7
20VW7	5.65 143.51	3.12 79.25	2.29 58.17	—	—

*20VW7, 20A model tested by Underwriters Laboratories to US and Canadian requirements and is VDE approved at 16A, 250VAC

1
RFI Power Line Filters

Multipurpose Power Line RFI Filter for Emission Control *(continued)*

V and W Series

Performance Data

Typical Insertion Loss

Measured in closed 50 Ohm system

— Common Mode / Asymmetrical (L-G)
— Differential Mode / Symmetrical (L-L)



Minimum Insertion Loss

Measured in closed 50 Ohm system

Common Mode / Asymmetrical (Line to Ground)

Current Rating	Frequency – MHz							
	.15	.5	1	2	5	10	20	30
V Series								
3A	15	27	38	47	55	55	50	48
6A	15	27	28	47	55	55	50	48
10A	15	27	38	47	55	55	50	48
20A	15	30	41	49	55	46	36	30
W Series								
3A	13	25	20	45	60	65	65	63
6A	18	30	34	40	65	65	57	47
10A	18	30	34	40	65	65	57	47
20A	18	30	34	40	65	65	57	47

Differential Mode / Symmetrical (Line to Line)

Current Rating	Frequency – MHz							
	.15	.5	1	2	5	10	20	30
V Series								
3A	25	25	65	63	60	52	50	50
6A	40	54	65	65	65	60	57	55
10A	25	25	65	63	60	52	50	50
20A	25	25	65	63	60	52	50	50
W Series								
3A	25	40	65	65	62	55	35	35
6A	30	54	65	65	60	55	38	38
10A	25	25	65	65	65	50	45	45
20A	25	25	65	65	65	50	45	45

High Performance, Low Cost Filter Ideal for Appliance Equipment

WG Series



UL Recognized
CSA Certified
VDE Approved



WG_1 Style

WG Series

- Cost-effective
- Tubular design
- WGA, WGB and WGC versions designed to comply with leakage current for fixed appliances not easily moved from one place to another
- WGD, WGE and WGF versions designed to comply with leakage current requirements for appliances which may be easily moved from one place to another
- Available in a variety of styles

Ordering Information



Specifications

Maximum leakage current each Line to Ground:

	A, B & C Models	D, E & F Models
@ 120 VAC 60 Hz:	.76 mA	.10 mA
@ 250 VAC 50 Hz:	1.27 mA	.20 mA

Hipot rating (one minute):

Line to Ground:	2250 VDC
Line to Line:	1450 VDC

Rated Voltage (max):

250 VAC

Operating Frequency:

50/60 Hz

Rated Current:

16A

Operating Ambient Temperature Range

(at rated current I_r): -10°C to +40°C

In an ambient temperature (T_a) higher than +40°C the maximum operating current (I_o) is calculated as follows: $I_o = I_r \sqrt{(85-T_a)/45}$

Electrical Schematics



With RAST 5 Connector (style 7)



Available Part Numbers

16WGA1	16WGA3	16WGA7
16WGB1	16WGB3	16WGB7
16WGC1	16WGC3	16WGC7
16WGD1	16WGD3	16WGD7
16WGE1	16WGE3	16WGE7
16WGF1	16WGF3	16WGF7

High Performance, Low Cost Filter for Appliance Equipment *(continued)*

WG Series

Case Styles

WG_1



Typical Dimensions:
Terminals (5): .25 [6.3] with .07 [1.8] Dia. hole
Mounting Stud (1): M8 x 1.25

WG_7

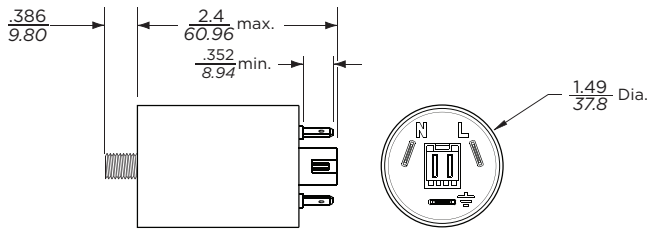

Typical Dimensions:
Terminals (3): .25 [6.3] with .07 [1.8] Dia. hole
RAST 5: Unkeyed RAST 5 Header interface*
Mounting Stud (1): M8 x 1.25

*The RAST 5 interface mates with any two-position (keyed or unkeyed) TE Standard Power Timer connector or RAST 5 Positive Lock Mark III connector

WG_3



Typical Dimensions:
Wire Leads(5): 4.0 [101.6] min. 18AWG UL 1015
Mounting Stud (1): M8 x 1.25

Wire Colors:

L(2)	Brown
N(4)	Blue
U(1)	Brown
Gnd	Green / Yellow
U(3)	Blue



WG_7 Style

High Performance, Low Cost Filter for Appliance Equipment *(continued)*

WG Series

Performance Data

Typical Insertion Loss

Measured in closed 50 Ohm system

All Case Styles

16WGA



16WGB



16WGC



16WGD



16WGE

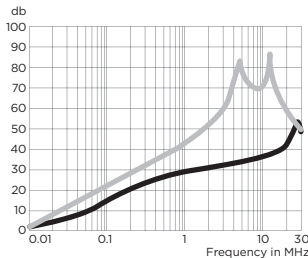

16WGF

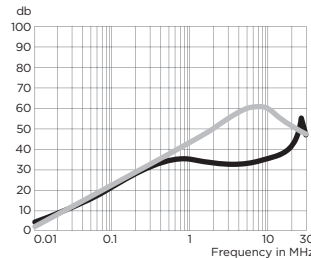

— Common Mode / Asymmetrical (L-G)
— Differential Mode / Symmetrical (L-L)

Minimum Insertion Loss

Measured in closed 50 Ohm system

Common Mode / Asymmetrical (Line to Ground)

Part No.	Frequency – MHz									
	.05	.1	.15	.5	1	2	5	10	20	30
All Styles										
16WGA	3	10	14	33	41	47	54	50	37	30
16WGB	11	16	21	33	39	44	53	55	37	30
16WGC	12	18	22	34	41	46	51	52	34	27
16WGD	3	8	11	22	26	31	31	33	40	44
16WGE	5	12	15	21	23	25	31	32	37	45
16WGF	9	14	18	24	26	28	31	32	37	44

Differential Mode / Symmetrical (Line to Line)

Part No.	Frequency – MHz									
	.05	.1	.15	.5	1	2	5	10	20	30
All Styles										
16WGA	14	19	22	33	41	51	47	42	48	50
16WGB	14	19	22	33	41	51	50	45	52	45
16WGC	13	19	22	33	40	50	58	42	48	42
16WGD	13	19	22	33	40	48	58	57	54	45
16WGE	13	19	22	33	40	48	58	57	51	45
16WGF	13	19	22	33	40	49	58	59	50	44

Chassis or PC Board Mountable Power Line Filters for Emission Control

X, Y, Z Series



UL Recognized
CSA Certified
VDE Approved



XP / YP / ZP



3EX1 / 3EZ1

X, Y, Z Series

- Compact chassis or PC board mountable
- Three levels of performance
- Complete filtering solution in minimal size

X Series

- Designed to bring most digital equipment (including those with switching power supplies) into compliance with FCC Part 15J, Class B conducted emission limits

Y Series

- Designed to bring most digital equipment (including those with switching power supplies) into compliance with EN55022, Level A and FCC Part 15J, Class B conducted emission limits

Z Series

- Designed to bring most digital equipment (including those with switching power supplies) into compliance with EN55022, Level B and FCC Part 15J, Class B conducted emission limits

Ordering Information



Specifications

Maximum leakage current each Line to Ground:

@ 120 VAC 60 Hz:	.30 mA
@250 VAC 50 Hz:	.50 mA

Hipot rating (one minute):

Line to Ground:	2250 VDC
Line to Line:	1450 VDC

Rated Voltage (max):

250 VAC

Operating Frequency:

50/60 Hz

Rated Current:

1 to 6A

Operating Ambient Temperature Range

(at rated current I_r): -10°C to +40°C

In an ambient temperature (T_a) higher than +40°C the maximum operating current (I_o) is calculated as follows: $I_o = I_r \sqrt{(85-T_a)/45}$

Electrical Schematic



Available Part Numbers

3EXP	4EYP
3EX1	1EZP
4EXP	2EZP
6EXP	3EZP
2EYP	3EZ1
3EYP	

Chassis & PC Board Mountable RFI Filters for Emission Control *(continued)*

X, Y, Z Series

Case Styles

X1 & Z1



Typical Dimensions:

- Line/Load Terminals (4): .250 [6.3] with .07 [1.8] Dia. hole
- Ground Terminal (1): .250 [6.3] with .07 x .16 [1.8 x 3.8] slot
- Mounting Holes (2): .188 [4.78] Dia.

XP, YP & ZP

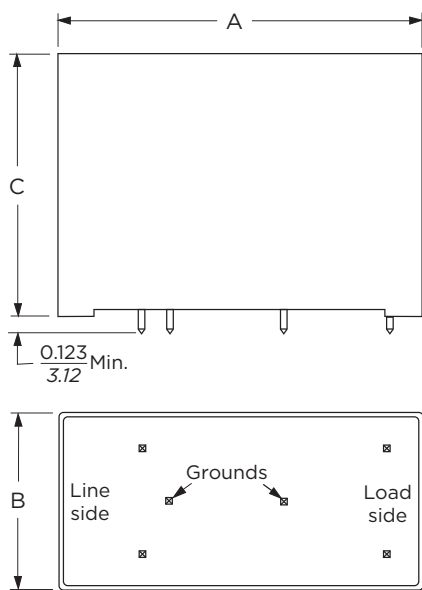

Typical Dimensions:

- Pins (5): 0.065 [1.65] max. diagonal

Case Dimensions

Part No.	A (max)	B (max)	C (max)	D $\pm .015$ $\pm .38$	E (max)
3EXP	2.61 66.3	1.13 28.7	1.62 41.1	—	—
3EX1	3.01 76.7	1.84 46.8	1.16 29.46	2.375 60.33	2.79 70.87
4EXP	2.61 66.6	1.13 28.7	1.62 41.1	—	—
6EXP	2.61 66.3	1.13 28.7	1.75 44.5	—	—
2EYP	2.61 66.3	1.13 28.7	1.62 41.1	—	—
3EYP, 4EYP	2.61 66.3	1.13 28.7	1.75 44.5	—	—
1EZP	2.61 66.3	1.13 28.7	1.62 41.1	—	—
2EZP, 3EZP	2.61 66.3	1.13 28.7	1.75 44.5	—	—
3EZ1	3.54 89.9	2.08 52.8	1.31 33.3	2.938 74.63	3.35 85.1

Recommended PC Board Layout



Chassis & PC Board Mountable RFI Filters for Emission Control *(continued)*

X, Y, Z Series

Performance Data

Typical Insertion Loss

Measured in closed 50 Ohm system

3EX



4EX



6EX

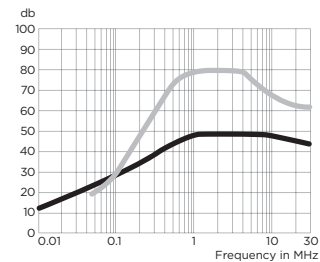

2EY



3EY



4EY

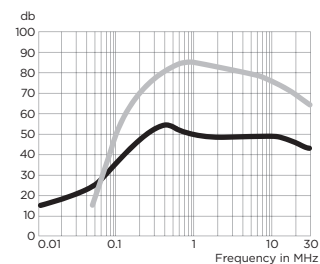

1EZ



2EZ



3EZ



— Common Mode / Asymmetrical (L-G)
— Differential Mode / Symmetrical (L-L)

Chassis & PC Board Mountable RFI Filters for Emission Control *(continued)*

Performance Data *(Continued)*

Minimum Insertion Loss

Measured in closed 50 Ohm system

Common Mode / Asymmetrical (Line to Ground)

Part No.	Frequency – MHz							
	.01	.05	.15	.5	1	5	10	30
X Series								
3A	2	13	21	35	46	44	44	44
4A	2	13	22	38	44	44	44	38
6A	2	11	20	35	40	40	40	36
Y Series								
2A	8	21	31	49	44	40	40	40
3A	11	24	36	43	40	40	40	40
4A	5	18	28	45	40	40	40	36
Z Series								
1A	18	32	43	47	44	43	43	45
2A	18	32	45	41	40	40	40	40
3A	15	29	39	43	42	40	40	40

Differential Mode / Symmetrical (Line to Line)

Part No.	Frequency – MHz									
	.02	.03	.05	.07	.15	.5	1	5	10	30
X Series										
3A	-	-	-	5	34	60	65	60	45	50
4A	-	-	-	10	37	70	70	70	65	55
6A	-	-	-	3	31	65	70	70	65	55
Y Series										
2A	-	-	10	19	40	70	75	70	60	55
3A	-	-	10	20	42	68	68	67	62	50
4A	-	-	6	18	41	67	75	70	65	55
Z Series										
1A	7	29	34	43	62	70	70	70	60	55
2A	2	15	31	40	57	75	70	65	55	50
3A	-	10	26	34	53	75	75	70	60	55



Engineering Notes

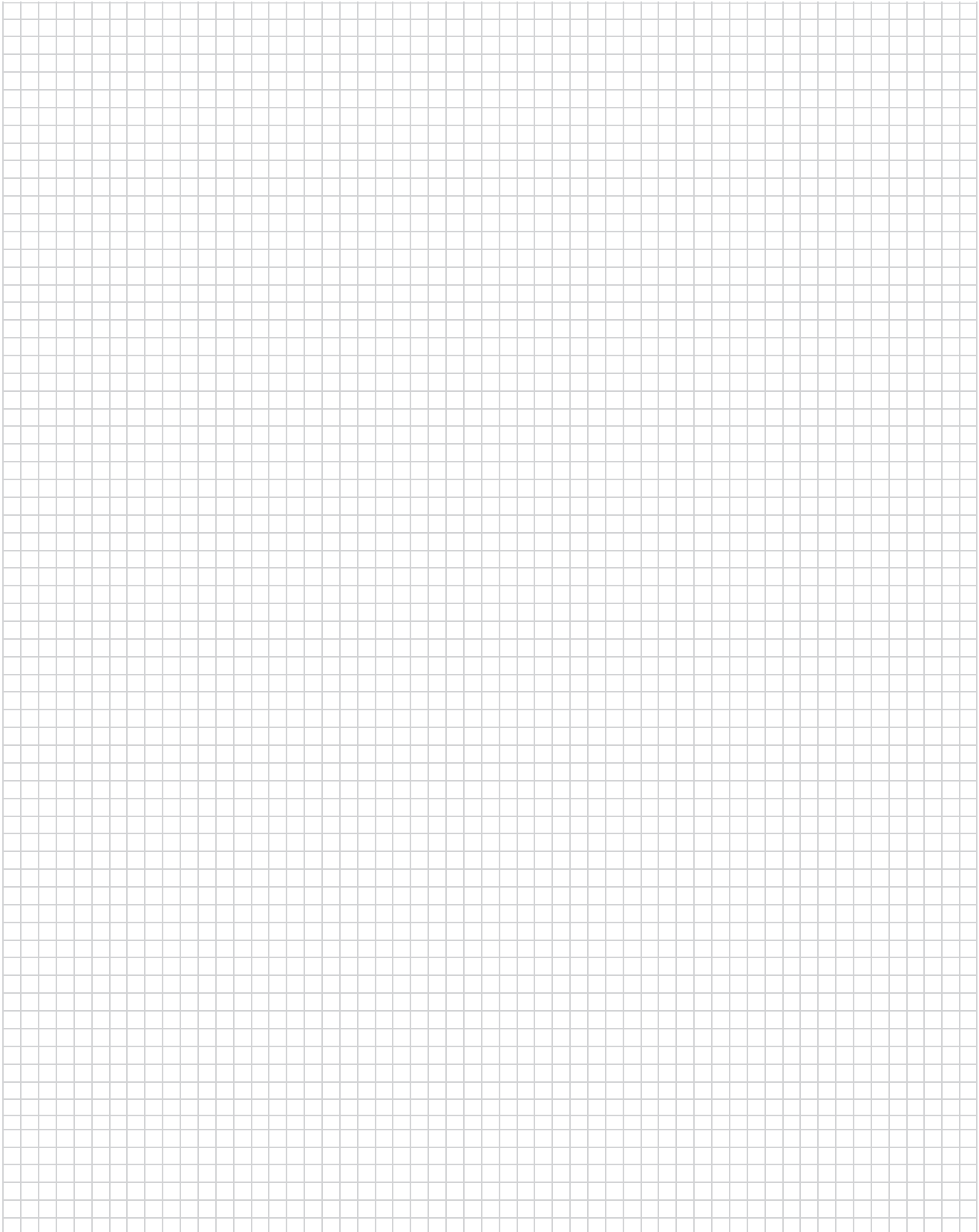

2. Three Phase Filters — Table of Contents

Three Phase Selector Chart97

A Series98

ADT Series101

AYA Series104

AYC Series108

AYO Series111

BCF Series113

CFN Series116

FCD Series118

Three Phase Selector Chart



High Performance 3-phase RFI Filters for WYE Applications

A Series



UL Recognized
CSA Certified
VDE Approved



A Series

- For 3-phase, four wire, WYE Applications
- Filters each of the three lines plus the neutral and ground line
- Both common mode and differential mode suppression from 50kHz to 30MHz
- Effective for both balanced and unbalanced loads
- Ground choke included
- Optional end bell kits available to shield input and output terminals
- AYP single stage for lower noise environments
- AYT dual stage provides highest performance

Ordering Information



Specifications

Maximum leakage current, each Line to Ground:

@ 120 VAC 60 Hz:	1.4 mA
@ 250 VAC 50 Hz:	3.4 mA

Hipot rating (one minute):

Line to Ground:	1500 VAC
Neutral to Ground:	1500 VAC
Line to Neutral:	1450 VDC

Rated Voltage (max):

Phase to Phase:	440 VAC
Phase to Neutral / Ground:	250 VAC

Operating Frequency:

50/60 Hz

Rated Current:

20 to 60A

Operating Ambient Temperature Range

(at rated current I_r): -10°C to +40°C
In an ambient temperature (T_a) higher than +40°C the maximum operating current (I_o) is calculated as follows: $I_o = I_r \sqrt{(85-T_a)/45}$

Electrical Schematics

AYP6C Models



High Performance 3-phase RFI Filters for WYE Applications *(continued)*

A Series

Electrical Schematics *(continued)*

AYT6C Models



Available Part Numbers

20AYP6C	20AYT6C
30AYP6C	30AYT6C
45AYP6C	45AYT6C
60AYP6C	60AYT6C

Accessories

Mounting bracket kit with captive nuts:

AA400: 20A & 30A versions

AA405: 45A & 60A versions



Protective cover for use with mounting bracket:

(For Europe only. Limited availability in other regions)

AA406A: 20A & 30A versions

AA407A: 45A & 60A versions

End bell kit (bracket and cover) with captive nuts:

AA406: 20A & 30A versions

AA407: 45A & 60A versions



AA406 / AA407
Kits includes both
bracket and cover

Additional captive nuts:

AA401: 10 nuts

Case Style



Case Dimensions

Part No.	A* (max.)	B (max.)	C (max.)	D ±.030 ±.76	E ±.015 ±.38
20AYP6C	8.82 224.0	5.57 141.5	2.56 65.0	4.616 117.2	1.50 38.1
30AYP6C	8.82 224.0	5.57 141.5	2.56 65.0	4.616 117.2	1.50 38.1
45AYP6C	9.43 239.5	6.92 175.8	4.82 122.4	5.95 151.1	3.75 95.3
60AYP6C	9.43 239.5	6.92 175.8	4.82 122.4	5.95 151.1	3.75 95.3
20AYT6C	13.82 351.0	5.57 141.5	2.56 65.0	4.616 117.2	1.50 38.1
30AYT6C	13.82 351.0	5.57 141.5	2.56 65.0	4.616 117.2	1.50 38.1
45AYT6C	13.83 351.3	6.92 175.8	4.82 122.4	5.95 151.1	3.75 95.3
60AYT6C	13.83 351.3	6.92 175.8	4.82 122.4	5.95 151.1	3.75 95.3

*For end bell covering terminals and connections, add:
20 & 30A: 5.57 [141.48]
45 & 60A: 6.45 [163.83]

High Performance 3-phase RFI Filters for WYE Applications *(continued)*

A Series

Performance Data

Typical Insertion Loss

Measured in closed 50 Ohm system

20AYP6C



30AYP6C



45AYP6C



60AYP6C



20AYT6C



30AYT6C



45AYT6C



60AYT6C



— Common Mode / Asymmetrical (L-G)
— Differential Mode / Symmetrical (L-L)

Minimum Insertion Loss

Measured in closed 50 Ohm system

AYP6C

Common Mode / Asymmetrical (Line to Ground)

Current Rating	Frequency –MHz							
	.05	.1	.15	.5	1	5	10	30
20A	22	32	39	55	56	65	65	54
30A	15	24	30	55	55	61	63	50
45A	8	19	25	49	49	56	58	45
60A	5	16	22	50	50	54	54	47

Differential Mode / Symmetrical (Line to Line)

Current Rating	Frequency –MHz							
	.05	.1	.15	.5	1	5	10	30
20A	20	38	50	65	65	65	60	52
30A	18	28	43	65	65	65	59	48
45A	8	20	27	60	65	65	56	43
60A	20	24	27	60	65	65	56	50

AYT6C

Common Mode / Asymmetrical (Line to Ground)

Current Rating	Frequency –MHz							
	.05	.1	.15	.5	1	5	10	30
20A	45	63	70	75	75	75	75	65
30A	29	53	61	75	75	75	75	60
45A	15	36	43	75	75	75	75	50
60A	12	37	46	75	75	75	70	45

Differential Mode / Symmetrical (Line to Line)

Current Rating	Frequency –MHz							
	.05	.1	.15	.5	1	5	10	30
20A	27	56	65	70	70	70	70	70
30A	17	46	55	75	75	75	75	70
45A	14	41	50	75	75	75	75	65
60A	26	50	58	75	75	75	75	60

High Performance High Current 3-phase Delta RFI Filters

ADT Series



UL Recognized



ADT Series

- Designed for very high insertion loss for Delta three phase, three wire applications
- Available with common or differential mode coils

Ordering Information



Available Part Numbers

63ADT6	63ADT6S
100ADT6	100ADT6S
160ADT6	160ADT6S
200ADT6	200ADT6S

Specifications

Maximum leakage current at 277 VAC 60 Hz, each Line to Ground:

ADT6:	1.3 A
63ADT6S:	2.6 A
100, 160, 200ADT6S	4.6 A

Hipot rating (one minute):

Line to Ground:	2210 VDC
Line to Line:	2158 VDC

Rated Voltage (max):

Phase to Phase:	480 VAC
Phase to Ground:	277 VAC

Operating Frequency:

50/60 Hz

Rated Current:

63 to 200A

Operating Ambient Temperature Range

(at rated current I_r):

-10°C to +40°C

In an ambient temperature (T_a) higher than +40°C the maximum operating current (I_o) is calculated as follows: $I_o = I_r \sqrt{(85 - T_a)/45}$

Electrical Schematics

63ADT6



High Performance High Current 3-phase Delta RFI Filters (continued)

ADT Series

Electrical Schematics (continued)

100, 160 & 200 ADT6



ADT6S



Case Style



Terminals (6) :
63ADT6, 63ADT6S, 100ADT6S: 3/8-16, Torque (max.) 70 lbf-in [7.91 N-m]
100ADT6, 160 & 200 ADT6/S: 7/16-20, Torque (max.) 125 lbf-in [14.12 N-m]

Case Dimensions

Part No.	A (max.)	B (max.)	C (max.)	D $\pm .030$ $\pm .76$	E (max.)	F $\pm .030$ $\pm .76$	G $\pm .030$ $\pm .76$	H $\pm .030$ $\pm .76$	J $\pm .030$ $\pm .76$	K (max.)
63ADT6	14.00 355.6	10.00 254.0	3.5 89.0	8.5 216.0	10.00 254.0	11.97 304.0	7.5 190.35	1.75 44.4	2.00 50.8	6.00 152.4
63ADT6S	19.00 482.6	10.00 254.0	4.5 114.3	8.5 216.0	15.00 381.0	16.97 431.0	7.5 190.5	3.00 76.2	3.00 76.2	6.00 152.4
100ADT6	19.00 482.6	10.00 254.0	4.5 114.3	8.5 216.0	15.00 381.0	16.97 431.0	7.5 190.5	3.00 76.2	3.00 76.2	6.00 152.4
100ADT6S	19.00 482.6	11.00 279.4	4.5 114.3	8.5 216.0	15.00 381.0	16.97 431.0	8.5 215.9	3.00 76.2	3.00 76.2	6.00 152.4
160/200ADT6	19.00 482.6	10.00 254.0	4.5 114.3	8.5 216.0	15.00 381.0	16.97 431.0	7.5 190.5	3.00 76.2	3.00 76.2	6.00 152.4
160/200ADT6S	22.00 558.8	13.00 330.2	4.5 114.3	11.5 292.2	18.00 457.2	19.97 507.2	10.5 266.7	2.75 69.8	3.00 76.2	7.00 177.8

High Performance High Current 3-phase Delta RFI Filters *(continued)*

ADT Series

Performance Data

Typical Insertion Loss

Measured in closed 50 Ohm system

63ADT6



100ADT6



160ADT6



200ADT6



63ADT6S



100ADT6S



160ADT6S



200ADT6S



— Common Mode / Asymmetrical (L-G)
- - - Differential Mode / Symmetrical (L-L)

Minimum Insertion Loss

Measured in closed 50 Ohm system

Common Mode / Asymmetrical (Line to Ground)

Part No.	Frequency –MHz						
	.01	.1	1	10	30	100	300
63ADT6	45	85	95	100	100	100	100
100ADT6	45	85	90	100	100	100	100
160ADT6	45	80	90	100	100	100	100
200ADT6	45	77	88	100	100	100	100
63ADT6S	28	45	90	90	90	90	90
100ADT6S	38	60	95	100	100	100	100
160ADT6S	37	58	85	100	100	100	100
200ADT6S	35	54	80	100	100	100	100

Differential Mode / Symmetrical (Line to Line)

Part No.	Frequency –MHz						
	.01	.1	1	10	30	100	300
63ADT6	35	100	100	100	100	100	100
100ADT6	43	100	100	100	100	100	100
160ADT6	44	100	100	100	100	100	100
200ADT6	43	100	100	100	100	100	100
63ADT6S	35	100	100	100	100	100	100
100ADT6S	43	100	100	100	100	100	100
160ADT6S	44	100	100	100	100	100	100
200ADT6S	43	100	100	100	100	100	100

3-phase WYE RFI Power Line Filters

AYA Series



UL Recognized*



25AYA6A

AYA Series

- For 3-phase, four wire, WYE applications
- Cost-effective, universal 3-phase filters
- Good attenuation over the complete frequency range of 10kHz to 30MHz
- Two different mounting styles available

Specifications

Maximum leakage current each Line to Ground:
 @ 120 VAC 60 Hz: 1.62 mA
 @ 250 VAC 50 Hz: 2.82 mA

Hipot rating (one minute):
 Line to Ground: 1500 VAC
 Line to Line: 1450 VDC

Rated Voltage (max):
 Phase to Phase: 440 VAC
 Phase to Ground: 250 VAC

Operating Frequency: 50/60 Hz

Rated Current: 16 to 100A*

Operating Ambient Temperature Range (at rated current I_r): -10°C to +40°C
 In an ambient temperature (T_a) higher than +40°C the maximum operating current (I_O) is calculated as follows: $I_O = I_r \sqrt{(85-T_a)/45}$

Ordering Information



Available Part Numbers

Flange Mount	Bulkhead Mount
16AYA6A	16AYA6
16AYA10	25AYA6
25AYA6A	36AYA6
36AYA6A	50AYA6
36AYA10	
50AYA6A	
63AYA6A	
63AYA10	
100AYA6A	

*UL Approvals for all models except: 16AYA10, 36AYA10, 63AYA10, 63AYA6, 63AYA6A and 100AYA6A

3-phase WYE RFI Power Line Filters (continued)

AYA Series

Electrical Schematic

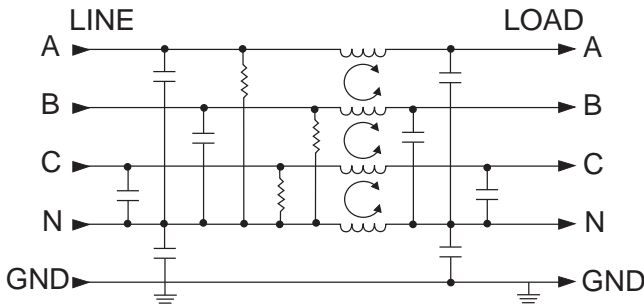

Case Style

AYA6A (Flange mount with screw terminals)



Typical Dimensions:
 Mounting slots (4): .425 x .254 [10.8 x 6.6]
 16 & 25A Terminals(8): 8-32, Torque (max.) 26 lbf-in [2.94 N-m]
 36A Terminals(8): 10-32, Torque (max.) 27 lbf-in [3.05 N-m]
 50, 63 & 100A Terminals(8): 1/4-20, Torque (max.) 56 lbf-in [6.33 N-m]

AYA6 (Bulkhead mount with screw terminals)



Typical Dimensions:
 Threaded mounting holes(4): M5 x 8
 16 & 25A Terminals(8): 8-32, Torque (max.) 26 lbf-in [2.94 N-m]
 36A Terminals(8): 10-32, Torque (max.) 27 lbf-in [3.05 N-m]
 50A Terminals(8): 1/4-20, Torque (max.) 56 lbf-in [6.33 N-m]

16AYA10



Typical Dimensions:
 Mounting slots (4): .425 x .254 [10.8 x 6.6]
 Terminal blocks(8): 4 mm² Torque (max.) 7.08 lbf-in [0.8 N-m]
 Ground terminal(1): M5, Torque (max.) 26.58 lbf-in [3.0 N-m]

2
Three Phase Filters

3-phase WYE RFI Power Line Filters (continued)

AYA Series

36AYA10



Typical Dimensions:
 Mounting slots (4): .425 x .254 [10.8 x 6.6]
 Terminal blocks(8): 10 mm² Torque (max.) 15.93 lbf-in [1.8 N-m]
 Ground terminal(1): M5, Torque (max.) 26.58 lbf-in [3.0 N-m]

63AYA10

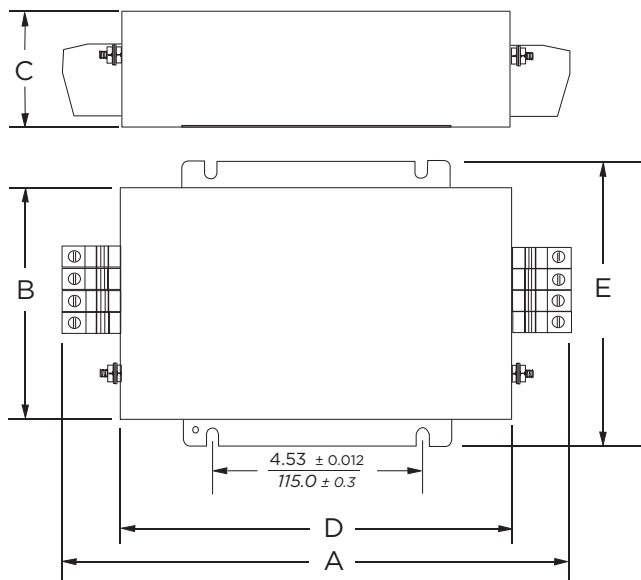

Typical Dimensions:
 Mounting slots (4): .425 x .254 [10.8 x 6.6]
 Terminal blocks(8): 16 mm² Torque (max.) 20.35 lbf-in [2.3 N-m]
 Ground terminal(1): M6, Torque (max.) 53.1 lbf-in [6.0 N-m]

Case Dimensions

Part No.	A (max.)	B (max.)	C (max.)	D (max.)	E* (max.)
16AYA6 /A	7.91	4.37	1.97	5.94	5.51
25AYA6 /A	201.0	111.0	50.0	151.0	140.0
36AYA6 /A	7.91	4.37	2.56	5.94	5.51
50AYA6 /A	201.0	111.0	65.0	151.0	140.0
63AYA6 /A	7.91	4.37	2.56	5.94	5.51
100AYA6A	201.0	111.0	65.0	151.0	140.0
16AYA10	6.97	4.37	1.97	5.94	5.51
	177.0	111.0	50.0	151.0	140.0
36AYA10	7.88	4.37	2.56	5.94	5.51
	200.0	111.0	65.0	151.0	140.0
63AYA10	10.98	5.08	2.95	8.43	6.26
	279.0	129.0	75.0	214.0	159.0

*Does not apply for bulkhead models

3-phase WYE RFI Power Line Filters *(continued)*

AYA Series

Performance Data

Typical Insertion Loss

Measured in closed 50 Ohm system

— Common Mode / Asymmetrical (L-G)
— Differential Mode / Symmetrical (L-L)

16AYA



25AYA



36AYA



50AYA



63AYA



100AYA



Minimum Insertion Loss

Measured in closed 50 Ohm system

Common Mode / Asymmetrical (Line to Ground)

Current Rating	Frequency –MHz							
	.01	.05	.1	.5	1	5	10	30
16A	2	11	19	52	53	70	61	30
25A	2	12	19	46	49	64	54	27
36A	1	10	18	49	54	63	57	32
50A	1	8	14	43	47	63	53	29
63A	2	10	22	50	60	75	70	55
100A	1	15	22	55	60	65	55	50

Differential Mode / Symmetrical (Line to Line)

Current Rating	Frequency –MHz							
	.01	.05	.1	.5	1	5	10	30
16A	14	31	30	82	87	76	77	47
25A	20	36	38	85	81	68	69	33
36A	20	39	36	86	78	65	62	35
50A	20	30	38	85	82	67	66	38
63A	30	40	45	90	85	70	70	60
100A	20	35	45	80	80	65	60	55

3-phase WYE RFI Power Line Filters for High Noise Applications

AYC Series



UL Recognized*



150AYC10B

AYC Series

- For 3-phase, four wire, WYE applications
- Very high attenuation
- Low leakage current
- Ideal for EMC troubleshooting and refurbishing in the field
- Touch safe terminals provide easy connections and prevent inadvertent contact for safety in the most demanding applications

Ordering Information

150 AYC 10 B -95



Available Part Numbers

16AYC10B	110AYC10B
25AYC10B	150AYC10B
36AYC10B	150AYC10B-95
63AYC10B	180AYC10B
80AYC10B	200AYC10B

Specifications

Maximum leakage current each Line to Ground:

	120 VAC 60Hz	277 VAC 50Hz
16A	62 mA	106 mA
25 & 36A	68 mA	118 mA
63A	74 mA	128 mA
80, 100 & 150A	74 mA	129 mA
180, 200A	111 mA	192 mA

Hipot rating (one minute):

Line to Ground:	1850 VDC
Line to Line:	1850 VDC
Line to Neutral:	1450 VDC

Rated Voltage (max):

Phase to Phase:	480 VAC
Phase to Ground:	277 VAC

Operating Frequency:

50/60 Hz

Rated Current:

16 to 200A

Operating Ambient Temperature Range

(at rated current I_r): -10°C to +40°C
In an ambient temperature (T_a) higher than +40°C the maximum operating current (I_o) is calculated as follows: $I_o = I_r \sqrt{(85-T_a)/45}$

Electrical Schematic

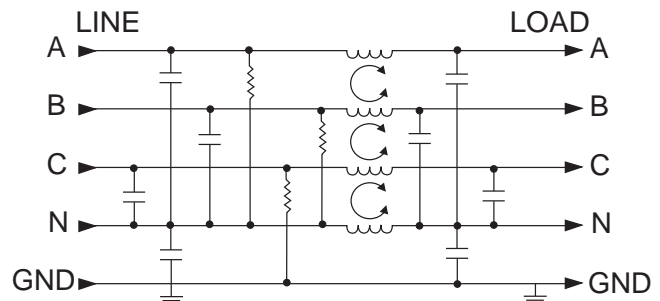

*All except 200AYC10B

3-phase WYE RFI Filters for High Noise Applications *(continued)*

AYC Series

Case Styles

16, 25, 36, 63AYC10B



80, 110, 150AYC10B / -95



180, 200AYC10B

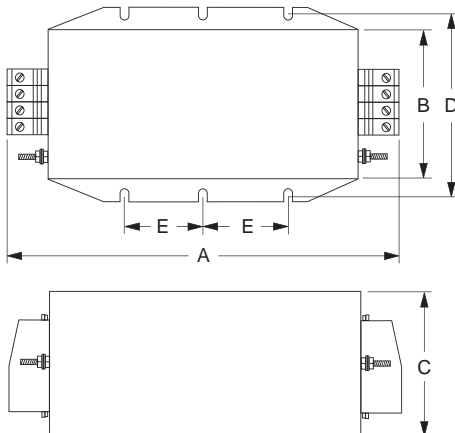

Case Dimensions

Part No.	A (max.)	B (max.)	C (max.)	D (max.)	E ± 0.078 $\pm .2$
16AYC10B	6.69 170.0	4.37 111.0	2.56 65.0	4.92 125.0	2.76 70.0
25AYC10B	9.96 246.0	5.08 129.0	2.52 64.0	5.71 145.0	4.53 115.0
36AYC10B	10.35 263.0	5.08 129.0	2.52 64.0	5.71 145.0	4.53 115.0
63AYC10B	10.98 279.0	5.08 129.0	2.95 75.0	5.71 145.0	4.53 115.0
80, 110 & 150AYC10B	12.09 307.0	5.55 141.0	5.55 141.0	6.10 155.0	4.53 115.0
150AYC10B-95	12.59 320.0	5.55 141.0	5.55 141.0	6.10 155.0	4.53 115.0
180AYC10B	15.71	5.55	5.55	6.10	3.25
200AYC10B	399.0	141.0	141.0	155.0	82.5

Terminals

Part No.	Terminal	Size	Torque max. lbf-in [N·m]
16AYC10B	Ground	M5	26.58 [3.0]
	Line / Load	4mm ² terminal block	7.08 [0.8]
25AYC10B	Ground	M5	26.58 [3.0]
	Line / Load	6mm ² terminal block	15.93 [7.8]
36AYC10B	Ground	M5	26.58 [3.0]
	Line / Load	10mm ² terminal block	15.93 [7.8]
63AYC10B	Ground	M6	53.1 [6.0]
	Line / Load	16mm ² terminal block	20.35 [2.3]
80, 110, 150AYC10B	Ground	M10	177.0 [20.0]
	Line / Load	50mm ² terminal block	70.80 [8.0]
150AYC10B-95 180AYC10B 200AYC10B	Ground	M10	177.0 [20.0]
	Line / Load	95mm ² terminal block	177.0 [20.0]

3-phase WYE RFI Filters for High Noise Applications *(continued)*

AYC Series

Performance Data

Typical Insertion Loss

Measured in closed 50 Ohm system

16AYC10B



25AYC10B



36AYC10B



63AYC10B



80AYC10B



110AYC10B



150AYC10B



180, 200AYC10B



— Common Mode / Asymmetrical (L-G)
— Differential Mode / Symmetrical (L-L)

Minimum Insertion Loss

Measured in closed 50 Ohm system

Common Mode / Asymmetrical (Line to Ground)

Part No.	Frequency –MHz							
	.01	.05	.1	.5	1	5	10	30
16AYC10B	23	66	82	88	82	79	55	21
25AYC10B	26	68	83	93	88	68	45	4
36AYC10B	18	61	78	96	91	71	49	7
63AYC10B	11	57	72	90	86	68	44	4
80AYC10B	10	57	75	84	77	75	62	45
110AYC10B	10	51	60	88	84	74	50	12
150AYC10B	-	50	57	82	79	75	51	7
150AYC10B-95	1	51	55	85	82	84	51	11
180, 200AYC10B	3	53	55	97	89	81	56	20

Differential Mode / Symmetrical (Line to Line)

Part No.	Frequency –MHz							
	.01	.05	.1	.5	1	5	10	30
16AYC10B	21	32	54	90	86	73	72	47
25AYC10B	23	33	60	100	95	87	70	38
36AYC10B	25	37	51	94	87	69	58	17
63AYC10B	27	45	41	84	77	63	61	43
80AYC10B	37	42	67	87	80	66	60	50
110AYC10B	27	35	39	75	72	51	44	31
150AYC10B	28	37	42	74	67	52	45	30
150AYC10B-95	28	40	42	73	66	51	44	31
180, 200AYC10B	30	41	50	70	64	49	42	26

Compact Low Current 3-phase WYE RFI Filters

AYO Series



UL Recognized
CSA Certified
VDE Approved



AYO Series

- For 3-phase, four wire, WYE applications
- Filters each of the three lines plus neutral
- Good for attenuation beginning at 100kHz
- Space saving design
- Low leakage current
- Easy to connect terminals

Ordering Information



Available Part Numbers

3AYO1	6AYO1
10AYO1	20AYO1

Specifications

Maximum leakage current each Line to Ground:

	<u>3, 6, 10A</u>	<u>20A</u>
@ 120 VAC 60 Hz:	2.0 mA	3.5 mA
@ 250 VAC 50 Hz:	3.0 mA	5.5 mA

Hipot rating (one minute):

Line to Ground:	1500 VAC
Line to Line:	1450 VDC

Rated Voltage (max):

Phase to Phase:	440 VAC
Phase to Neutral / Ground:	250 VAC

Operating Frequency:

50/60 Hz

Rated Current:

3 to 20A

Operating Ambient Temperature Range

(at rated current I_r): -10°C to +40°C
In an ambient temperature (T_a) higher than +40°C the maximum operating current (I_o) is calculated as follows: $I_o = I_r \sqrt{(85-T_a)/45}$

Electrical Schematic



2
Three Phase Filters

Compact Low Current 3-phase WYE RFI Filters *(continued)*

AYO Series

Case Style



Typical Dimensions:

- Line/Load Terminals (8): .250 [6.3] with .07 [1.8] Dia. hole
- Ground Terminal (1): .250 [6.3] with .07 x .16 [1.8 x 3.8] slot
- Mounting Holes (2): .188 [4.78] Dia.

Case Dimensions

Part No.	A (max.)	B (max.)	C (max.)	D ± 0.15 $\pm .38$	E (max.)
AYO Series	3.37	2.07	1.53	2.938	3.35
	85.6	52.5	38.7	74.63	85.1

Performance Data

Typical Insertion Loss

Measured in closed 50 Ohm system

3AYO1



6AYO1



10AYO1



20AYO1



— Common Mode / Asymmetrical (L-G)
— Differential Mode / Symmetrical (L-L)

Minimum Insertion Loss

Measured in closed 50 Ohm system

Common Mode / Asymmetrical (Line to Ground)

Current Rating	Frequency –MHz					
	.15	.5	1	5	10	30
3A	12	23	29	33	38	35
6A	7	23	30	40	50	30
10A	-	-	5	16	28	15
20A	-	7	11	32	23	12

Differential Mode / Symmetrical (Line to Line)

Current Rating	Frequency –MHz					
	.15	.5	1	5	10	30
3A	-	12	20	50	35	30
6A	10	18	24	31	28	28
10A	10	18	24	42	28	22
20A	10	18	24	42	38	23

Compact 3-phase Delta RFI Filters for Universal Applications

BCF Series



UL Recognized
VDE Approved



BCF Series

- Designed for universal applications
- Compact book-form design
- Low weight
- Insulated, high quality safety terminals for input and output
- Cost-effective design
- Good common and differential mode performance below 100kHz
- Applications include; 3-phase inverters, converters, variable speed motor drives and process automation equipment
- Touch safe terminals provide easy connections and prevent inadvertent contact for safety in the most demanding applications

Ordering Information



Available Part Numbers

7BCF10	16BCF10
30BCF10	42BCF10
55BCF10	75BCF10
100BCF10	130BCF10
180BCF10	

Specifications

Maximum leakage current each Line to Ground*:
@ 277 VAC 50 Hz: 30 mA

**If 2 phases are interrupted, this leakage current may rise to a significantly higher level*

Hipot rating (one minute):
Line to Ground: 1850 VAC
Line to Line: 1850 VDC

Rated Voltage (max):
Phase to Phase: 480 VAC
Phase to Ground: 277 VAC

Operating Frequency: 50/60 Hz

Rated Current: 7 to 180A

Operating Ambient Temperature Range (at rated current I_r): -10°C to +50°C

In an ambient temperature (T_a) higher than +50°C the maximum operating current (I_o) is calculated as follows: $I_o = I_r \sqrt{(85-T_a)/35}$

Electrical Schematic

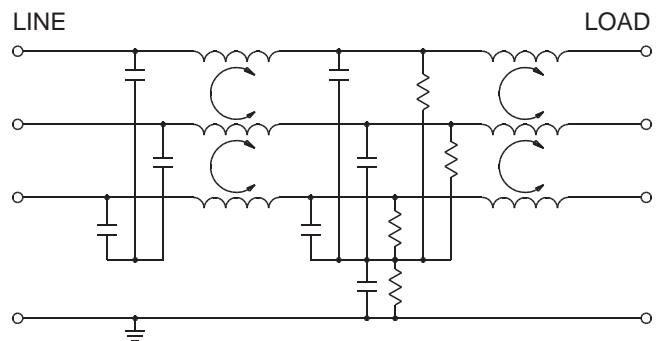

Compact 3-phase Delta Filters for Universal Applications *(continued)*

BCF Series

Case Style



Terminals

Part No.	Ground Terminals	Line/Load Terminals
7BCF10, 16BCF10	M5	4mm ²
30BCF10	M5	10mm ²
42BCF10	M6	10mm ²
55BCF10	M6	16mm ²
75BCF10	M6	25mm ²
100BCF10, 130BCF10	M10	50mm ²
180BCF10	M10	95mm ²

Case Dimensions

Part No.	A (max.)	B (max.)	C (max.)	D (max.)	E (max.)	F (max.)	G (max.)	H (max.)
7BCF10	6.30 <i>160.0</i>	1.57 <i>40.0</i>	2.76 <i>70.0</i>	7.48 <i>190.0</i>	.03 <i>.8</i>	.79 <i>20.0</i>	7.09 <i>180.0</i>	.18 <i>4.5</i>
16BCF10	8.66 <i>220.0</i>	1.77 <i>45.0</i>	2.76 <i>70.0</i>	9.84 <i>250.0</i>	.03 <i>.8</i>	.98 <i>25.0</i>	9.25 <i>235.0</i>	.21 <i>5.4</i>
30BCF10	9.45 <i>240.0</i>	1.97 <i>50.0</i>	3.35 <i>85.0</i>	10.63 <i>270.0</i>	.03 <i>.8</i>	1.18 <i>30.0</i>	10.04 <i>255.0</i>	.21 <i>5.4</i>
42BCF10	11.02 <i>280.0</i>	1.97 <i>50.0</i>	3.35 <i>85.0</i>	12.20 <i>310.0</i>	.03 <i>.8</i>	1.18 <i>30.0</i>	11.61 <i>295.0</i>	.21 <i>5.4</i>
55BCF10	8.66 <i>220.0</i>	3.35 <i>85.0</i>	3.54 <i>90.0</i>	9.84 <i>250.0</i>	.04 <i>1.0</i>	2.36 <i>60.0</i>	9.25 <i>235.0</i>	.21 <i>5.4</i>
75BCF10	9.45 <i>240.0</i>	3.15 <i>80.0</i>	5.31 <i>135.0</i>	10.63 <i>270.0</i>	.04 <i>1.0</i>	2.36 <i>60.0</i>	10.04 <i>255.0</i>	.26 <i>6.5</i>
100BCF10	9.45 <i>240.0</i>	3.54 <i>90.0</i>	5.91 <i>150.0</i>	10.63 <i>270.0</i>	.04 <i>1.0</i>	2.56 <i>65.0</i>	10.04 <i>255.0</i>	.26 <i>6.5</i>
130BCF10	9.45 <i>240.0</i>	3.54 <i>90.0</i>	5.91 <i>150.0</i>	10.63 <i>270.0</i>	.04 <i>1.0</i>	2.56 <i>65.0</i>	10.04 <i>255.0</i>	.26 <i>6.5</i>
180BCF10	13.78 <i>350.0</i>	4.72 <i>120.0</i>	6.69 <i>170.0</i>	14.96 <i>380.0</i>	.04 <i>1.0</i>	4.2 <i>102.0</i>	14.37 <i>365.0</i>	.26 <i>6.5</i>

Compact 3-phase Delta Filters for Universal Applications *(continued)*

BCF Series

Performance Data

Typical Insertion Loss

Measured in closed 50 Ohm system

7BCF10



16BCF10



30BCF10



42BCF10



55BCF10



75BCF10



100BCF10



130BCF10



— Common Mode / Asymmetrical (L-G)
— Differential Mode / Symmetrical (L-L)

180BCF10



Minimum Insertion Loss

Measured in closed 50 Ohm system

Common Mode / Asymmetrical (Line to Ground)

Current Rating	Frequency –MHz											
	.01	.03	.05	.1	.15	.3	.5	1	3	5	10	30
7A	18	39	48	62	68	89	96	83	62	53	41	20
16A	17	37	45	58	65	85	96	88	65	56	43	23
30A	16	36	44	58	64	82	90	74	56	48	36	18
42A	12	30	40	52	61	79	90	72	54	47	35	18
55A	16	35	44	58	66	87	87	67	47	38	26	12
75A	12	30	40	53	60	84	90	70	50	42	30	15
100A	12	29	38	50	59	79	80	67	49	40	29	15
130A	11	26	35	48	55	78	83	67	49	40	29	15
180A	11	27	36	49	57	72	77	61	47	40	29	15

Differential Mode / Symmetrical (Line to Line)

Current Rating	Frequency –MHz											
	.01	.03	.05	.1	.15	.3	.5	1	3	5	10	30
7A	16	23	28	54	67	89	85	76	67	62	57	46
16A	18	26	24	48	58	78	82	80	74	71	65	51
30A	23	31	29	49	62	87	84	78	68	64	59	46
42A	13	35	36	50	67	88	82	69	59	55	50	40
55A	27	35	35	51	68	87	83	71	61	58	54	31
75A	27	35	35	50	66	87	86	72	62	58	53	35
100A	28	37	38	47	70	73	76	78	68	64	58	34
130A	27	37	40	38	53	75	80	64	54	50	47	30
180A	27	37	40	42	50	73	73	60	50	47	42	30

3-phase Delta Power Line Filter for High Voltage Applications

CFN Series



UL Recognized*



CFN Series

- Universal high current filter
- Suitable for industrial applications including; motor drives, inverters, converters, uninterruptible power supplies and mining equipment

Ordering Information



Available Part Numbers

300CFN12	400CFN12
500CFN12	600CFN12

**400CFN12 only*

Specifications

Maximum leakage current at 10% unsymmetrical mains Line to Ground (3 Phase WYE Center tapped)*:

- @ 120 VAC 60 Hz: 5.0 mA
- @ 277 VAC 50 Hz: 9.6 mA

**If 2 phases are interrupted, this leakage current may rise to a significantly higher level*

Hipot rating (one minute):

- Line to Ground: 2210 VDC
- Line to Line: 2158 VDC

Rated Voltage (max):

- Phase to Phase: 480 VAC
- Phase to Ground: 277 VAC

Operating Frequency:

50/60 Hz

Rated Current:

300 to 600A

Operating Ambient Temperature Range

(at rated current I_r): -10°C to +40°C
In an ambient temperature (T_a) higher than +40°C the maximum operating current (I_o) is calculated as follows: $I_o = I_r \sqrt{(85 - T_a) / 45}$

Electrical Schematic

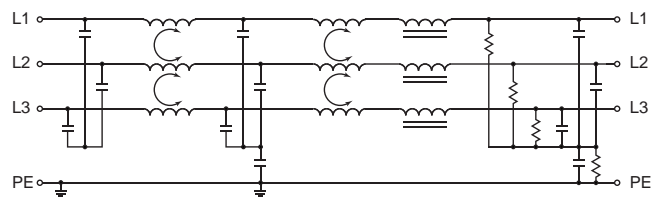

3-phase Delta Power Filter for High Voltage Applications *(continued)*

CFN Series

Case Style



Case Dimensions

Part No.	A (max.)	B (max.)	C (max.)	D1 (ref.)	D2 (max.)	E $\pm .02$ $\pm .50$	F (max)	G $\pm .02$ $\pm .50$	H (max.)
300-600CFN12	24.8 <i>630.0</i>	11.81 <i>300.0</i>	6.30 <i>160.0</i>	22.20 <i>564.0</i>	20.31 <i>516.0</i>	10.83 <i>275.0</i>	9.84 <i>250.0</i>	8.66 <i>220.0</i>	5.0 <i>127.0</i>

Performance Data

Typical Insertion Loss

Measured in closed 50 Ohm system

300-600CFN12



— Common Mode / Asymmetrical (L-G)
- - - Differential Mode / Symmetrical (L-L)

Minimum Insertion Loss

Measured in closed 50 Ohm system

Common Mode / Asymmetrical (Line to Ground)

Current Rating	Frequency –MHz									
	.01	.03	.07	.1	.15	.5	1	5	10	30
300-600A	10	19	26	40	55	82	76	51	37	20

Differential Mode / Symmetrical (Line to Line)

Current Rating	Frequency –MHz									
	.01	.03	.07	.1	.15	.5	1	5	10	30
300-600A	32	40	27	55	70	66	57	40	34	20

3-phase Delta External Power Line Filter for Frequency Converters

FCD Series



UL Recognized



6FCD10

FCD Series

- Suitable to meet the latest EMC standards
- Insulated safety terminals
- Suitable for EMC troubleshooting in the field
- Very high attenuation
- High insertion loss
- BS models optimized for very high insertion loss
- BS models suitable for infeed/regenerative (ER) applications
- Touch safe terminals provide easy connections and prevent inadvertent contact for safety in the most demanding applications

Ordering Information



Specifications

Maximum leakage current

voltage drop to virtual N to PE/V:

6FCD10:	.26 mA/V
12 & 16FCD10:	.45 mA/V
25, 36 & 50FCD10:	.52 mA/V
12 & 16FCD10B:	.46 mA/V
25 & 36FCD10B:	.52 mA/V
50FCD10B:	.57 mA/V
80 & 110FCD10B:	.62 mA/V
150FCD10B:	.63 mA/V
180 & 230FCD10B:	.92 mA/V
FCD10BS:	3.25 mA/V

Hipot rating (one minute):

Line to Ground:	2250 VDC
Line to Line:	1450 VDC

Rated Voltage (max):

Phase to Phase:	480 VAC
Phase to Neutral / Ground:	277 VAC

Operating Frequency:

50/60 Hz

Rated Current:

6 to 230A

Operating Ambient Temperature Range

(at rated current I_r): -10°C to +40°C

In an ambient temperature (T_a) higher than +40°C the maximum operating current (I_o) is calculated as follows: $I_o = I_r \sqrt{(85 - T_a)/45}$

Electrical Schematics

6FCD10



3-phase Delta External Filter for Frequency Converters *(continued)*

FCD Series

Electrical Schematics *(continued)*

12 to 50A FCD10



12 to 50A FCD10B



80 to 230A FCD10B



FCD10BS



Available Part Numbers

6FCD10	12FCD10B	50FCD10BS
12FCD10	16FCD10B	80FCD10BS
16FCD10	25FCD10B	110FCD10BS
25FCD10	36FCD10B	150FCD10BS
36FCD10	50FCD10B	150FCD10BS-95
50FCD10	80FCD10B	180FCD10BS
	110FCD10B	230FCD10BS
	150FCD10B	
	150FCD10B-95	
	180FCD10B	
	230FCD10B	

Case Styles

6 to 50A FCD10 & FCD10B



80 to 150A FCD10B 50 to 150A FCD10BS



3-phase Delta External Filter for Frequency Converters *(continued)*

FCD Series

Case Styles *(continued)* 180 to 230FCD10B\BS



Terminals

Part No.	Terminal	Size	Torque max. lbf-in [N-m]
6FCD10	Ground	8-32	20.7 [2.34]
	Line/Load	4mm ² terminal block	7.08 [0.8]
12FCD10/10B 16FCD10/10B	Ground	M5	26.58 [3.0]
	Line/Load	4mm ² terminal block	7.08 [0.8]
25FCD10/10B 36FCD10/10B	Ground	M5	26.58 [3.0]
	Line/Load	6mm ² terminal block	15.93 [1.8]
50FCD10/10B	Ground	M5	26.58 [3.0]
	Line/Load	10mm ² terminal block	15.93 [1.8]
50FCD10BS	Ground	M10	88.5 [10.0]
	Line/Load	16mm ² terminal block	20.36 [2.3]
80 to 150FCD10B 80 to 150FCD10BS	Ground	M10	88.5 [10.0]
	Line/Load	50mm ² terminal block	70.80 [8.0]
150FCD10B/BS-95 180FCD10B/BS 230FCD10B/BS	Ground	M10	88.5 [10.0]
	Line/Load	95mm ² terminal block	177.0 [20.0]

Case Dimensions

Part No.	A (max.)	B (max.)	C (max.)	D $\pm .02$ $\pm .5$	E (max.)	F $\pm .02$ $\pm .5$
6FCD10	6.18	4.33	2.32	3.74	5.16	2.76
12FCD10/10B 16FCD10/10B	157.0	110.0	59.0	95.0	131.0	70.0
25FCD10/10B 36FCD10/10B 50FCD10/10B	6.97	5.51	2.56	4.92	5.94	2.76
50FCD10BS	177.0	140.0	65.0	125.0	151.0	70.0
80FCD10B/BS 110FCD10B/BS 150FCD10B/BS	9.69	6.26	2.52	5.71	8.43	4.53
150FCD10B-95 150FCD10BS-95	246.0	159.0	64.0	145.0	214.0	115.0
180FCD10B/BS 230FCD10B/BS	11.41	6.61	3.54	6.10	8.70	4.53
50FCD10BS	290.0	168.0	90.0	155.0	221.0	115.0
80FCD10B/BS 110FCD10B/BS 150FCD10B/BS	12.09	6.61	5.55	6.10	8.70	4.53
150FCD10B-95 150FCD10BS-95	307.0	168.0	141.0	155.0	221.0	115.0
180FCD10B/BS 230FCD10B/BS	15.71	6.61	5.55	6.10	11.81	6.50
	399.0	168.0	141.0	155.0	300.0	165.0

Performance Data

Typical Insertion Loss

Measured in closed 50 Ohm system

6FCD10



12FCD10

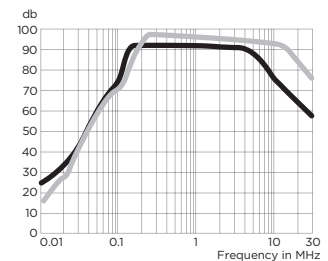

— Common Mode / Asymmetrical (L-G)
— Differential Mode / Symmetrical (L-L)

3-phase Delta External Filter for Frequency Converters *(continued)*

FCD Series

Performance Data *(continued)*

Typical Insertion Loss *(continued)*

Measured in closed 50 Ohm system

16FCD10



25FCD10



36FCD10



50FCD10



12FCD10B



16FCD10B



25FCD10B



36FCD10B



50FCD10B



80FCD10B



110FCD10B



150FCD10B



180FCD10B



230FCD10B



50/80/110FCD10BS



150FCD10BS



180FCD10BS



230FCD10BS



— Common Mode / Asymmetrical (L-G)
— Differential Mode / Symmetrical (L-L)

3-phase Delta External Filter for Frequency Converters *(continued)*

FCD Series

Performance Data *(continued)*

Minimum Insertion Loss

Measured in closed 50 Ohm system

Common Mode / Asymmetrical (Line to Ground)

Part No.	Frequency –MHz								
	.01	.03	.05	.1	.5	1	5	10	30
6FCD10	2	14	23	39	56	52	48	45	33
12 & 16FCD10	13	30	36	45	75	75	52	45	35
25FCD10	13	30	36	45	75	75	52	45	35
36FCD10	9	26	32	40	75	75	52	45	35
50FCD10	9	26	32	40	75	75	52	45	35
12FCD10B	18	45	59	75	73	65	49	47	26
16FCD10B	18	45	59	75	73	65	49	47	26
25FCD10B	18	45	60	49	83	75	58	56	28
36FCD10B	8	38	52	70	77	70	54	50	47
50FCD10B	3	34	49	67	76	70	59	58	37
80FCD10B	2	35	49	67	74	67	59	58	27
110FCD10B	2	35	49	66	72	65	59	58	18
150FCD10B	1	36	50	66	69	63	59	58	9
180FCD10B	-	36	50	66	67	60	59	58	-
230FCD10B	-	25	40	58	73	66	58	52	21
50FCD10BS	40	66	70	69	65	60	53	51	24
80FCD10BS	35	63	67	66	63	58	52	49	23
110FCD10BS	30	61	69	69	66	60	53	53	25
150FCD10BS	32	61	67	67	62	56	48	46	16
180FCD10BS	30	60	65	65	61	55	47	46	16
230FCD10BS	27	58	62	63	59	54	46	45	15

Differential Mode / Symmetrical (Line to Line)

Part No.	Frequency –MHz								
	.01	.03	.05	.1	.5	1	5	10	30
6FCD10	9	8	24	40	62	57	50	48	38
12 & 16FCD10	9	13	24	55	75	75	75	65	60
25FCD10	9	13	26	55	75	75	75	65	60
36FCD10	9	13	26	46	75	75	75	65	60
50FCD10	9	13	26	46	75	75	75	65	60
12FCD10B	6	13	9	37	90	86	74	78	34
16FCD10B	6	13	9	37	60	86	74	78	34
25FCD10B	10	16	12	41	89	87	69	86	43
36FCD10B	17	24	24	38	87	81	63	66	24
50FCD10B	15	24	27	21	88	74	51	69	52
80FCD10B	17	25	28	23	87	71	50	62	45
110FCD10B	18	27	30	25	86	69	49	56	39
150FCD10B	19	28	31	28	85	66	49	49	32
180FCD10B	21	29	33	30	84	63	48	43	26
230FCD10B	22	31	35	36	78	60	46	41	26
50FCD10BS	25	31	26	59	73	64	50	45	19
80FCD10BS	25	31	26	59	73	64	50	45	19
110FCD10BS	24	31	24	55	72	65	51	46	26
150FCD10BS	25	33	32	51	71	61	47	42	22
180FCD10BS	25	33	32	51	71	61	47	42	22
230FCD10BS	25	33	32	51	71	61	47	42	22

Engineering Notes



Engineering Notes



3. Power Inlet Filters & Power Entry Modules – Table of Contents

Introduction126

Selector Chart128

Power Entry Module Selector Guide129

 C Series130

 CU Series134

 EBF Series138

 EC Series141

 ED Series144

 EEA & EEB Series148

 EAS & EBS Models148

 EAH & EBH Models148

 EEJ Series153

 EJH & EJHS Models153

 EJM & EJMS Models153

 EJS Models153

 EF Series160

 EJT Series163

 GG & HG Series166

 H Series169

 J Series172

 L Series175

 LA Series180

 M Series183

 P Series192

 SR Series201

 SRB Series203



Introduction



Corcom EJS Series
IEC Inlet RFI Filter

Power Inlet Filters feature power sockets integrated with EMI filters enclosed in RFI jackets. The AC power socket complies with IEC an standard to assure worldwide power cord compatibility. These filters are available in a wide variety of filtering, shielding, mounting and termination styles that provide the most compact and cost-effective inlet filtering available. For DC power inlet filters, see the DC section.



Corcom P Series CHAMELEON
Power Entry Module

Power Entry Modules incorporate power sockets with filtering, fuses, switching and voltage selection in a variety of configurations to reduce cost, space and labor. The power sockets comply with IEC standards to assure worldwide AC power cord compatibility. For DC power entry modules, see the DC section.

Equipment marketed worldwide, must operate with

- Multiple different wall plugs and sockets
- Different fuse standards in America and Europe
- Different voltages in different regions
- On/Off switching options
- Different EMI requirements in different regions

The combinations are endless. Your equipment needs a single solution.

TE Connectivity's power entry modules can provide ONE mechanical solution for a variety of power entry needs. Each series supports several different configurations to suit the market requirements. Each starts with an international standard power cord connector, and includes options for fusing, voltage selection, switching, and filtering. Selecting one power entry module series simplifies the mechanical design, and each version within the series replaces the cost and labor of up to including up to five individual parts in the equipment bill of materials. With hundreds of different combinations of power entry functions, the modules in this catalog offer a cost-effective solution to the power entry needs of many systems. It is easy to select the module that best serves your needs.

Introduction *(continued)*

The selector guides on the next two pages help you configure the best power entry module for your application. Just select options from this menu of five categories.

IEC60320-1 Socket – Common to all modules, the 60320-1 universal socket allows your equipment to be used in every country. Simply select a power cord with a mating IEC 60320-1 plug on one end, and a regionally appropriate plug on the other.

Fusing Options – North American ($\frac{1}{4}$ " x $\frac{1}{4}$ " 3AG) or Metric (5mm x 20mm) or both? One fuse or two?

Voltage Selection Options – 4-voltage, 2-voltage, or 1-voltage? Multitap? Center-tap? Dual primary?

Power Switch – Yes or no? Double pole (DPST) or single (SPST)? These power entry module switches feature international on - off markings, current ratings up to 15A and high inrush current.

Shielding – reduce radiated emissions through the panel cut-out by selecting a module with a shield (optional on the C, CU, M and P).

Filtering options – Choice of six filter circuits (all with low leakage current to meet international standards) to fit specific filtering objectives:

- **General purpose** (C, CU, GG, J, LA, M and P) – most cost-effective, for susceptibility and for high-frequency “clean-up” when used with a board-level filter
- **Medical** (in C, GG, L, M, and P series) – for medical equipment
- **Emissions/Linear** (in L and P series) – capable of bringing most digital equipment with linear power supplies into FCC compliance
- **Emissions/SMPS-FCC** (in P, LA and M series) – capable of bringing most digital equipment with switch-mode power supplies into FCC Class B compliance
- **Emissions/SMPS-VDE** (in P, LA and M series) – capable of bringing most digital equipment with switch-mode power supplies into VDE level B (as well as FCC Class B) compliance

Want more filtering options? Select a general purpose or an unfiltered module (C, CU, J, L, M, P, or SR series) and wire it up connect it to the load through one of the many Corcom chassis-mounted filter of your choice from the choices found in this comprehensive catalog. TE’s Corcom product engineers can also design a custom filter for your specific applicaiton.

Available accessories expand your options even further. A Corcom product sales engineer can assist you with selecting the right filter for your application.

Having arrived at the best possible combination of power entry elements, TE’s worldwide agency approvals will help ease your product through the necessary safety agencies. File numbers and Safety Agency information is listed in Section 7.

Selector Chart



Power Entry Module Selector Guide

Series	Unfiltered		Filtered			Options		
	Product Photo	Max. Current Rating	Product Photo	Max. Current Rating	Filter Type	On/Off Switch	Voltage Selections	Fuse Holder
C		15A NEW		10A	Medical & General Purpose	Yes DPST	N/A	N/A
CU NEW		15A		15A	General Purpose	Yes SPST	N/A	N/A
GG	Filtered Only			10A	Medical & General Purpose	N/A	N/A	Metric
L		6A		6A	Medical & General Purpose	Optional DPST	Single or 4	North American or Metric
M		6A		6A	Medical, General Purpose & Switch Mode Power Supply	Optional DPST	Single, 2 or 4	North American or Metric
P		10A		10A	Medical, General Purpose & Switch Mode Power Supply	Optional DPST	Single or 2	North American or Metric
New High Performance versions in PE and PM Mounting Styles								

N/A = Not Available

Power Entry Module with Switch

C Series



UL Recognized
CSA Certified
VDE Approved*



C Series

- Two function power entry module combining a DPST switch and an IEC 60320-1 inlet
- Snap-in or flange mounting
- Available with or without a shielded general purpose or medical grade filter
- Two element circuit provides enhanced EMI attenuation
- Reduce OEM wiring time with optional pre-connected line and switch terminals

Ordering Information



*15A versions are tested by Underwriters Laboratories to US and Canadian requirements and are VDE approved at 10A, 250VAC

Specifications

Maximum leakage current each Line to Ground:

	F Models	H & Unfiltered
@ 120 VAC 60 Hz:	.25 mA	2 µA
@250 VAC 50 Hz:	.40 mA	5 µA

Hipot rating (one minute):

Line to Ground:	2250 VDC
Line to Line:	1450 VDC

Rated Voltage: 250 VAC

Operating Frequency: 50/60 Hz

Rated Current: 1 to 15A*

Switch: DPST
10,000 operations at 51A max. inrush

.250 Terminal Push-on Force: 18 lb. / 80N (max.)

.188 Terminal Push-on Force: 15 lb. / 67N (max.)

Available Part Numbers

Filtered Versions	
1CHE1	1CFE1
3CHE1	3CFE1
6CHE1	6CFE1
10CHE1	10CFE1
1CHS1	1CFS1
3CHS1	3CFS1
6CHS1	6CFS1
10CHS1	10CFS1
Non-filtered Versions	
Standard Terminals	Pre-connected Terminals
10CS1	10CBS1
10CE1	10CBE1
15CS1	15CBS1
15CE1	15CBE1

Power Entry Module with Switch *(continued)*

C Series

Electrical Schematics

F Models



H Models



B Models



Note 1: Jumpers provided on CBS and CBE versions only
Note 2: Location of optional filter

Case Styles

CS, CBS



Typical Dimensions:
Line Inlet (1): IEC 60320-1 C14
Terminals (6): .187 [4.8] with .055 [1.4] Dia. hole
Ground Terminal (1): .187 [4.8] with .112 x .06 [2.8 x 1.5] slot

CE, CBE



Typical Dimensions:
Mounting holes (2): .13 [3.3] Dia. with .23 [5.9] Dia. x 90° countersink for #4 flathead screw
Line Inlet (1): IEC 60320-1 C14
Terminals (6): .187 [4.8] with .055 [1.4] Dia. hole
Ground Terminal (1): .187 [4.8] with .112 x .06 [2.8 x 1.5] slot

CFS, CHS



Typical Dimensions:
Line Inlet (1): IEC 60320-1 C14
Terminals (3): .25 [6.35] with .07 [1.8] Dia. hole

CFE, CHE



Typical Dimensions:
Mounting holes (2): .13 [3.3] Dia. with .23 [5.9] Dia. x 90° countersink for #4 flathead screw
Line Inlet (1): IEC 60320-1 C14
Terminals (3): .25 [6.35] with .07 [1.8] Dia. hole

Power Entry Module with Switch *(continued)*

C Series

Case Styles *(continued)*

CBS, CBE Pre-Connected Terminals



CBS, CBE Side View

CBE Rear View

CBS Rear View

Recommended Panel Cutout



Panel Thickness: .031 - .098 [0.8 - 2.5]
 Not recommended for plastic panels.
 Snap-in models suitable for front mounting only.
 For Snap-in applications, the D sides of the cutout must have a .02 [.508] radius on the installation side.

Case Dimensions

Part No.	A (max.)	B (max.)	C (max.)	D $\pm .01$ $\pm .254$	E $\pm .01$ $\pm .254$	F $\pm .006$ $\pm .152$
CS, CBS	1.22 31.0	.93 23.6	1.62 41.2	1.06 26.92	1.54* 39.12*	-
CE, CBE	1.74 44.2	.93 23.6	1.62 41.2	1.06 26.92	1.56 39.62	1.417 36.0
CFS, CHS	1.22 31.0	2.53 64.3	1.62 41.2	1.12 28.5	1.54* 39.12*	-
CFE, CHE	1.74 44.2	2.53 64.3	1.62 41.2	1.12 28.5	1.56 39.62	1.417 36.0

*+ .000 [.000] / - .008 [.20]

Accessories

GA400: NEMA 5-15P to IEC 60320-1 C-13 line cord



Power Entry Module with Switch *(continued)*

C Series

Performance Data

Typical Insertion Loss

Measured in closed 50 Ohm system

1CF



3CF



6CF



10CF



1CH



3CH



6CH



10CH



— Common Mode / Asymmetrical (L-G)
— Differential Mode / Symmetrical (L-L)

Minimum Insertion Loss

Measured in closed 50 Ohm system

Common Mode / Asymmetrical (Line to Ground)

Current Rating	Frequency – MHz						
	.05	.15	.5	1	5	10	30
F Models							
1A	10	26	46	48	46	47	46
3A	8	16	32	36	43	48	50
6A	4	11	22	27	36	41	50
10A	1	4	14	18	27	33	42
H Models							
1A	16	21	37	44	26	21	10
3A	9	14	31	32	26	24	14
6A	4	10	22	23	19	18	13
10A	2	6	10	15	11	11	9

Differential Mode / Symmetrical (Line to Line)

Current Rating	Frequency – MHz						
	.05	.15	.5	1	5	10	30
F Models							
1A	1	3	13	28	62	67	42
3A	2	6	14	23	65	65	67
6A	2	6	14	27	46	48	58
10A	1	7	14	23	42	44	62
H Models							
1A	1	6	13	29	38	42	26
3A	1	5	10	22	36	34	36
6A	1	5	14	20	31	33	37
10A	1	4	11	19	32	37	38

Compact 1U Height Switched Power Entry Module

CU Series



UL Recognized
CSA Certified
VDE Approved*



CU Series

- Designed for popular 1U (1 3/4") height rack mounted equipment
- Two function power entry module combining a SPST switch and an IEC 60320-1 inlet
- Snap-in, flange and flush mounting
- Reduce OEM wiring time with optional pre-connected line and switch terminals

Ordering Information



Specifications

Maximum leakage current each Line to Ground:

	<u>Filtered</u>	<u>Unfiltered</u>
@ 120 VAC 60 Hz:	.25 mA	2 µA
@250 VAC 50 Hz:	.40 mA	5 µA

Hipot rating (one minute):

Line to Ground:	2250 VDC
Line to Line:	1450 VDC

Operating Voltage:

120/250 VAC

Operating Frequency:

50/60 Hz

Rated Current:

1 to 15A*

Switch:

50A inrush capable SPST

Terminal Push-on Force:

15 lb. / 67N (max.)

Available Part Numbers

Filtered Versions		
1CUFE1	1CUFF1	1CUFS1
3CUFE1	3CUFF1	3CUFS1
6CUFE1	6CUFF1	6CUFS1
10CUFE1	10CUFF1	10CUFS1
15CUFE1	15CUFF1	15CUFS1
Non-filtered Versions		
Standard Terminals	Pre-connected Terminals	
15CUE1	15CUBE1	
15CUS1	15CUBS1	
15CU10S1	15CU10BS1	
15CU15S1	15CU15BS1	

*15A versions are tested by Underwriters Laboratories to US and Canadian requirements and are VDE approved at 10A, 250VAC

Compact 1U Height Switched Power Entry Module *(continued)*

CU Series

Electrical Schematic



Case Styles

CUFE1



Typical Dimensions:

Mounting holes (2):	.138 [3.5] Dia. with .228 [5.8] Dia. x 90° countersink for M3 flathead screw
Line Inlet (1):	IEC 60320-1 C14
Terminals (2):	.187 [4.8] with .055 [1.4] Dia. hole
Ground Terminal (1):	.187 [4.8] with .112 x .06 [2.8 x 1.5] slot
Output Shroud:	.21 x .34 [5.2 x 8.6] inside dimension

CUFF1



For rear mounted applications only. Maximum panel thickness: .157 [4.0]

Typical Dimensions:

Mounting Holes(2):	M3 x 0.5 Threaded flange
Line Inlet (1):	IEC 60320-1 C14
Terminals (2):	.187 [4.8] with .055 [1.4] Dia. hole
Ground Terminal (1):	.187 [4.8] with .112 x .06 [2.8 x 1.5] slot
Output Shroud:	.21 x .34 [5.2 x 8.6] inside dimension

CUFS1

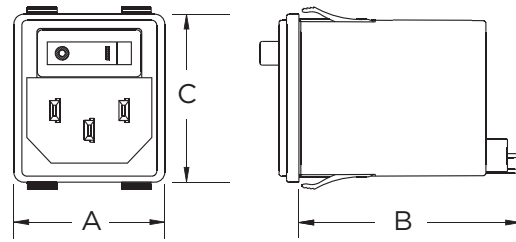

Typical Dimensions:

Line Inlet (1):	IEC 60320-1 C14
Terminals (2):	.187 [4.8] with .055 [1.4] Dia. hole
Ground Terminal (1):	.187 [4.8] with .112 x .06 [2.8 x 1.5] slot
Output Shroud:	.21 x .34 [5.2 x 8.6] inside dimension

CUE1



Note: Switch output terminal configuration may vary

Typical Dimensions:

Mounting holes (2):	.138 [3.5] Dia. with .228 [5.8] Dia. x 90° countersink for M3 flathead screw
Line Inlet (1):	IEC 60320-1 C14
Terminals (4):	.187 [4.8] with .055 [1.4] Dia. hole
Ground Terminal (1):	.187 [4.8] with .112 x .06 [2.8 x 1.5] slot

CUS1



Note: Switch output terminal configuration may vary

Typical Dimensions:

Line Inlet (1):	IEC 60320-1 C14
Terminals (4):	.187 [4.8] with .055 [1.4] Dia. hole
Ground Terminal (1):	.187 [4.8] with .112 x .06 [2.8 x 1.5] slot

Compact 1U Height Switched Power Entry Module *(continued)*

CU Series

Case Styles *(continued)*

CU10S1 & CU15S1

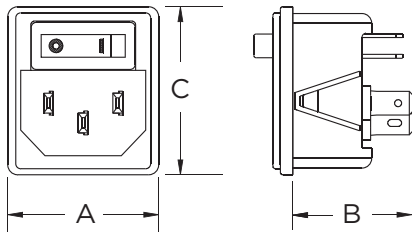

Available for panel thickness .07 - 1.0mm (CU10S1) or 1.2 - 1.5mm CU15S1
Note: Switch output terminal configuration may vary

Typical Dimensions:

Line Inlet (1):	IEC 60320-1 C14
Terminals (4):	.187 [4.8] with .055 [1.4] Dia. hole
Ground Terminal (1):	.187 [4.8] with .112 x .06 [2.8 x 1.5] slot

CUBE1 Pre-Connected Terminals

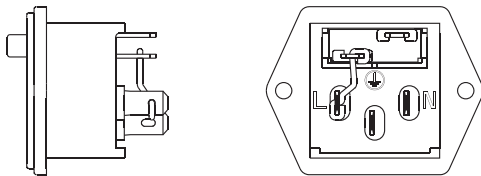

CUBS1 Pre-Connected Terminals



CU10BS1 & CU15BS1 Pre-Connected Terminals



Case Dimensions

Part No.	A (max.)	B (max.)	C (max.)	D $\pm .004$ $\pm .100$	E $\pm .004$ $\pm .100$	F $\pm .004$ $\pm .100$
CUFE1	1.73 43.9	1.75 44.5	1.34 34.1	1.11 28.1	1.26 31.9	1.45 36.8
CUFF1	1.7 43.1	1.8 45.0	1.34 34.1	1.21 30.8	1.35 34.3	1.45 36.8
CUFS1	1.20 30.6	1.8 45.0	1.34 34.1	1.11 28.1	1.26 32.0	-
CUE1, CUBE1	1.73 43.9	.96 24.6	1.34 34.1	1.06 26.9	1.09 27.6	1.45 36.8
CUS1, CUBS1	1.20 30.6	0.97 24.6	1.34 34.1	1.04 26.4	1.26 32.0	-
10CUS1, 10CUBS1	1.20 30.6	0.97 24.6	1.34 34.1	1.05 26.7	1.24 31.6	-
15CUS1, 15CUBS1	1.20 30.6	0.97 24.6	1.34 34.1	1.05 26.7	1.24 31.6	-

Recommended Panel Cutout



Model	Panel Thickness	R Dim.
CUFF1	.157 [4.0] max.	1.8 [45.72]
CUFS1, CUS1	.025 - .082 [0.63 - 2.1]	1.0 [25.4]
CU10S1	.028 - .039 [0.7 - 1.0]	1.0 [25.4]
CU15S1	.047 - .059 [1.2 - 1.5]	1.0 [25.4]

Note 1: CUFF1 allows for back mounting only
Note 2: All other models allow for front mounting only

Accessories

GA400: NEMA 5-15P to IEC 60320-1 C-13 line cord



Compact 1U Height Switched Power Entry Module *(continued)*

CU Series

Performance Data

Typical Insertion Loss

Measured in closed 50 Ohm system

1CUF



3CUF



6CUF



10CUF



15CUF



— Common Mode / Asymmetrical (L-G)
— Differential Mode / Symmetrical (L-L)

Minimum Insertion Loss

Measured in closed 50 Ohm system

Common Mode / Asymmetrical (Line to Ground)

Current Rating	Frequency – MHz						
	.05	.15	.05	1	5	10	30
1A	19	30	44	49	47	44	45
3A	13	23	37	43	47	44	49
6A	5	14	28	34	43	43	48
10A	1	7	19	25	35	36	52
15A	-	1	10	13	25	27	42

Differential Mode / Symmetrical (Line to Line)

Current Rating	Frequency – MHz						
	.05	.15	.05	1	5	10	30
1A	1	10	21	26	48	51	60
3A	1	10	20	26	42	45	65
6A	1	10	20	23	38	41	65
10A	1	10	20	23	29	34	56
15A	1	10	20	23	28	39	54

Accessory Outlet Filter

EBF Series



UL Recognized
CSA Certified
VDE Approved



EBF Series

- Accessory IEC 60320-1 C13 filtered outlet
- Allows connection of accessories while filtering noise between a system and the accessory
- Enhanced performance across the frequency range
- Grounded connection
- Suitable for international usage

Ordering Information



Specifications

Maximum leakage current each Line to Ground:
 @ 120 VAC 60 Hz: .25 mA
 @ 250 VAC 50 Hz: .50 mA

Hipot rating (one minute):
 Line to Ground: 2250 VDC
 Line to Line: 1450 VDC

Rated Voltage (max.): 250 VAC

Operating Frequency: 50/60 Hz

Rated Current: 1 to 10A

Operating Ambient Temperature Range (at rated I_r): -10°C to +40°C
 In an ambient temperature (T_a) higher than +40°C the maximum operating current (I_o) is calculated as follows: $I_o = I_r \sqrt{(85-T_a)/45}$

Electrical Schematic

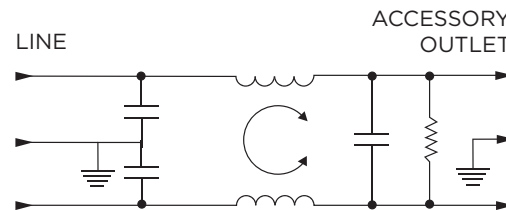

Available Part Numbers

1EBF1	1EBF4
3EBF1	3EBF4
6EBF1	6EBF4
10EBF1	10EBF4

Accessory Outlet Filter *(continued)*

EBF Series

Case Styles

EBF1



Typical Dimensions:

- Mounting holes (2): .132 [3.35] Dia. with .236 [5.99] Dia. x 90° countersink for #4 flathead screw
- Load Outlet (1): IEC 60320-1 C13
- Line Terminals (2): .250 [6.3] with .07 [1.8] Dia. hole
- Ground Terminal (1): .250 [6.3] with .07 x .16 [1.8 x 3.8] slot

EBF4



Typical Dimensions:

- Mounting holes (2): .132 [3.35] Dia. with .236 [5.99] Dia. x 90° countersink for #4 flathead screw
- Load Outlet (1): IEC 60320-1 C13
- Wire Leads (3): 10.0 [254.0] min., 18AWG, UL1015

Case Dimensions

Part No.	A (max.)	B (max.)	C (max.)	D $\pm .01$ $\pm .25$	E (max.)
EBF1	2.57 <i>65.3</i>	1.33 <i>33.8</i>	1.00 <i>25.4</i>	1.575 <i>40.01</i>	1.99 <i>50.5</i>
EBF4	2.09 <i>53.01</i>	1.39 <i>35.31</i>	1.16 <i>29.46</i>	1.575 <i>40.01</i>	1.99 <i>50.5</i>

Recommended Panel Cutout



Front Mount Only
Tolerance + .008 [.203] / - .000 [.000]

Accessory Outlet Filter *(continued)*

EBF Series

Performance Data

Typical Insertion Loss

Measured in closed 50 Ohm system

1EBF



3EBF



6EBF



10EBF



— Common Mode / Asymmetrical (L-G)
— Differential Mode / Symmetrical (L-L)

Minimum Insertion Loss

Measured in closed 50 Ohm system

Common Mode / Asymmetrical (Line to Ground)

Current Rating	Frequency – MHz						
	.05	.15	.5	1	5	10	30
1A	23	32	41	47	47	47	40
3A	10	19	30	36	48	50	47
6A	1	10	22	28	42	48	47
10A	1	5	14	20	32	38	47

Differential Mode / Symmetrical (Line to Line)

Current Rating	Frequency – MHz						
	.05	.15	.5	1	5	10	30
1A	3	14	23	41	47	50	44
3A	2	11	14	25	38	44	40
6A	2	10	14	20	33	42	40
10A	2	10	16	19	19	39	40

High Performance EMI Power Inlet Filter

EC Series



UL Recognized
CSA Certified
VDE Approved



EC Series

- Three element differential mode circuit provides the highest attenuation of any available standard inlet filter
- High common mode inductance
- High differential mode capacitance
- Effective attenuation of Line to Ground and Line to Line noise across the frequency range
- Performance and application similar to the ED series but with higher differential mode performance
- Includes several termination options

Ordering Information



Specifications

- Maximum leakage current each Line to Ground:**
- @ 120 VAC 60 Hz: .25 mA
 - @ 250 VAC 50 Hz: .50 mA
- Hipot rating (one minute):**
- Line to Ground: 2250 VDC
 - Line to Line: 1450 VDC
- Rated Voltage (max.):** 250 VAC
- Operating Frequency:** 50/60 Hz
- Rated Current:** 1 to 10A
- Operating Ambient Temperature Range (at rated current I_r):** -10°C to +40°C
- In an ambient temperature (T_a) higher than +40°C the maximum operating current (I_O) is calculated as follows: $I_O = I_r \sqrt{(85-T_a)/45}$

Electrical Schematic



Available Part Numbers

1EC1	1EC2	1EC4	1EC8
3EC1	3EC2	3EC4	3EC8
6EC1	6EC2	6EC4	6EC8
10EC1			

High Performance EMI Power Inlet Filter *(continued)*

EC Series

Case Styles

EC1



EC2



Typical Dimensions:

- Line Inlet (1): IEC 60320-1 C14
- Load Terminals (2): .250 [6.3] with .07 [1.8] Dia. hole
- Ground Terminal (1): .250 [6.3] with .07 x .16 [1.8 x 3.8] slot

EC4



EC8



Typical Dimensions:

- Line Inlet (1): IEC 60320-1 C14
- Wire Leads: 4.0 [101.6] Min., 18AWG, UL1015

Case Dimensions

Part No.	A (max.)	B (max.)	C (max.)	D $\pm .015$ $\pm .38$	E (max.)	F (ref.)
EC1	2.62 66.5	1.19 30.2	0.81 20.6	1.575 40.01	1.98 50.3	-
EC2	1.97 50.0	1.19 30.2	0.85 21.6	1.575 40.01	1.98 50.3	-
EC4	1.97 50.0	1.19 30.2	0.85 21.6	1.575 40.01	1.98 50.3	.295 7.5
EC8	1.98 50.0	1.19 30.2	0.81 20.6	1.575 40.01	1.98 50.3	.298 7.5

Recommended Panel Cutouts



Tolerances $\pm .005$ [0.13] unless otherwise noted

- Note 1: EC1 and EC8 allow for front or back mounting
- Note 2: EC2 and EC4 allow for back mounting only

Accessories

GA400: NEMA 5-15P to IEC 60320-1 C-13 line cord



FA601: Insulating Shroud

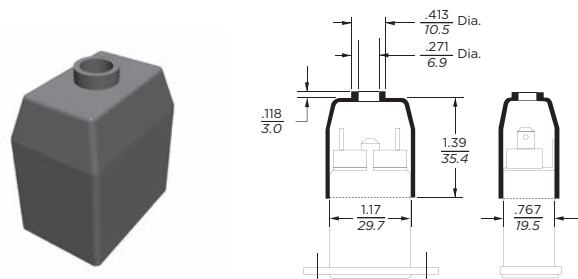

High Performance EMI Power Inlet Filter *(continued)*

EC Series

Performance Data

Typical Insertion Loss

Measured in closed 50 Ohm system

1EC



3EC



6EC



10EC



— Common Mode / Asymmetrical (L-G)
— Differential Mode / Symmetrical (L-L)

Minimum Insertion Loss

Measured in closed 50 Ohm system

Common Mode / Asymmetrical (Line to Ground)

Current Rating	Frequency – MHz					
	.15	.5	1	5	10	30
1A	25	35	40	50	50	50
3A	20	30	37	47	48	50
6A	15	22	25	40	45	50
10A	7	14	20	35	39	48

Differential Mode / Symmetrical (Line to Line)

Current Rating	Frequency – MHz						
	.15	.5	1	5	10	20	30
EC1, EC2 & EC8							
1A	5	35	50	60	60	40	40
3A	5	25	45	60	55	34	34
6A	10	10	40	65	60	40	40
10A	10	10	27	65	56	38	38
EC4							
1A	5	35	50	60	60	33	33
3A	5	30	45	60	55	34	34
6A	10	10	40	65	60	33	33

Medium Performance Compact EMI Power Inlet Filter

ED Series



UL Recognized
CSA Certified
VDE Approved*



ED Series

- Two element circuit provides medium attenuation
- Available with an internal ground-circuit inductor (C versions) to isolate equipment chassis from power line ground at radio frequencies
- Versions up to 15A*
- Similar to EEJ Series with alternative termination options
- See the EC Series for better differential mode performance

Ordering Information

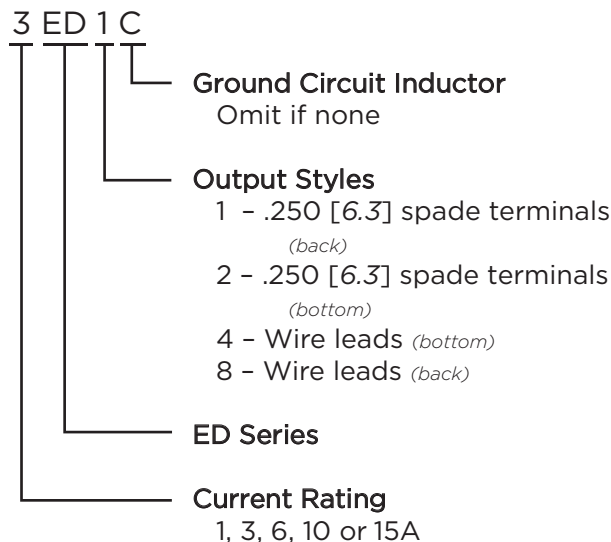

*15A versions are tested by Underwriters Laboratories to US and Canadian requirements and are VDE approved at 10A, 250VAC

Specifications

Maximum leakage current each Line to Ground:
 @ 120 VAC 60 Hz: .22 mA
 @ 250 VAC 50 Hz: .38 mA

Hipot rating (one minute):
 Line to Ground: 2250 VDC
 Line to Line: 1450 VDC

Rated Voltage (max.): 250 VAC

Operating Frequency: 50/60 Hz

Rated Current: 1 to 15A*

Operating Ambient Temperature Range (at rated current I_r): -10°C to +40°C
 In an ambient temperature (T_a) higher than +40°C the maximum operating current (I_O) is calculated as follows: $I_O = I_r \sqrt{(85-T_a)/45}$

Available Part Numbers

1ED1	1ED2	1ED4	1ED8
3ED1	3ED2	3ED4	3ED8
6ED1	6ED2	6ED4	6ED8
10ED1			
15ED1			15ED8
Ground Circuit Inductor Versions			
6ED1C		6ED4C	6ED8C
10ED1C			

Electrical Schematic

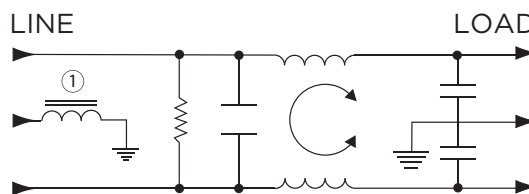

Note 1: C versions only

Medium Performance Compact EMI Power Inlet Filter (continued)

ED Series

Case Styles

ED1 & ED1C



Typical Dimensions:
 Mounting holes (2): .132 [3.35] Dia. with .236 [5.99] Dia. x 90° countersink for #4 flathead screw
 Line Inlet (1): IEC 60320-1 C14
 Load Terminals (2): .250 [6.3] with .07 [1.8] Dia. hole
 Ground Terminal (1): .250 [6.3] with .07 x .16 [1.8 x 3.8] slot

ED2



Typical Dimensions:
 Mounting holes (2): .132 [3.35] Dia. with .236 [5.99] Dia. x 90° countersink for #4 flathead screw
 Line Inlet (1): IEC 60320-1 C14
 Load Terminals (2): .250 [6.3] with .07 [1.8] Dia. hole
 Ground Terminal (1): .250 [6.3] with .07 x .16 [1.8 x 3.8] slot

ED4 & ED4C



Typical Dimensions:
 Mounting holes (2): .132 [3.35] Dia. with .236 [5.99] Dia. x 90° countersink for #4 flathead screw
 Line Inlet (1): IEC 60320-1 C14
 Wire Leads: 4.0 [101.6] Min., 18AWG, UL1015

ED8 & ED8C



Typical Dimensions:
 Mounting holes (2): .132 [3.35] Dia. with .236 [5.99] Dia. x 90° countersink for #4 flathead screw
 Line Inlet (1): IEC 60320-1 C14
 Wire Leads: 4.0 [101.6] Min., 18AWG, UL1015

Case Dimensions

Part No.	A (max.)	B (max.)	C (max.)	D $\pm .015$ $\pm .38$	E (max.)	F (ref.)
1ED1, 3ED1, 6ED1	2.21	1.19	0.81	1.575	1.98	-
1ED2, 3ED2, 6ED2	1.55	1.19	0.85	1.575	1.98	-
1ED4, 3ED4, 6ED4	1.55	1.19	0.85	1.575	1.98	.295
1ED8, 3ED8, 6ED8	1.55	1.19	0.81	1.575	1.98	.295
6ED1C	2.62	1.19	0.81	1.575	1.98	-
6ED4C	1.98	1.19	0.85	1.575	1.98	.295
6ED8C	1.98	1.19	0.81	1.575	1.98	.295
10ED1 /1C, 15ED1	2.62	1.19	0.81	1.575	1.98	-
15ED8	1.98	1.19	0.81	1.575	1.98	-

Medium Performance Compact EMI Power Inlet Filter *(continued)*

ED Series

Recommended Panel Cutouts



Note 1: ED1 and ED8 allow for front or back mounting
Note 2: ED2 and ED4 allow for back mounting only

Accessories

GA400: NEMA 5-15P to IEC 60320-1 C-13 line cord



FA601: Insulating Shroud



Performance Data

Typical Insertion Loss

Measured in closed 50 Ohm system

1ED



3ED

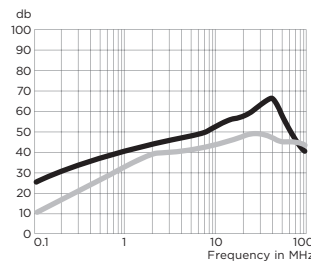

6ED

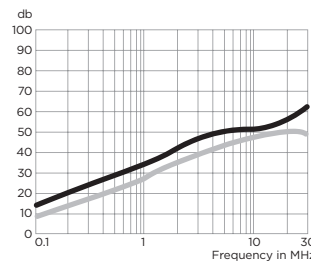

6ED1C



10ED1 & 10ED1C



15ED

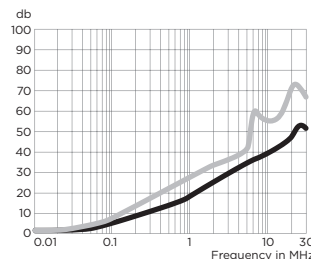

— Common Mode / Asymmetrical (L-G)
— Differential Mode / Symmetrical (L-L)

Medium Performance Compact EMI Power Inlet Filter *(continued)*

ED Series

Performance Data *(continued)*

Minimum Insertion Loss

Measured in closed 50 Ohm system

Common Mode / Asymmetrical (Line to Ground)

Current Rating	Frequency – MHz					
	.15	.5	1	5	10	30
ED1, ED2, ED4 & ED8						
1A	24	35	42	49	52	54
3A	20	29	36	45	50	54
6A	14	23	30	41	45	50
10A	8	14	20	35	39	45
15A	4	9	12	28	34	40
ED1C						
6A	14	20	25	37	42	50
10A	8	14	20	35	39	45
ED4C & ED8C						
6A	14	20	25	37	42	50

Differential Mode / Symmetrical (Line to Line)

Current Rating	Frequency – MHz					
	.15	.5	1	5	10	30
ED1, ED2, ED4 & ED8						
1A	3	15	20	37	37	36
3A	3	15	20	37	37	36
6A	3	15	20	31	35	34
10A	6	15	20	23	44	47
15A	6	18	23	33	44	47
ED1C						
6A	7	17	23	36	42	42
10A	6	15	20	23	44	47
ED4C & ED8C						
6A	7	17	23	29	38	42



Cost-effective EMI Power Inlet Filter

EEA & EEB Series

Including the EAS/EBS and EAH/EBH Models



**UL Recognized
CSA Certified
VDE Approved**



EEA Series

- Compact single stage EMI filter with IEC 60320-1 C14 inlet
- Two element circuit provides basic attenuation
- Same performance as the EF Series
- Available in three terminal configurations
- Supersedes EF Series

EEB Series

- Compact EMI filter with IEC 60320-1 C14 inlet
- Two element circuit provides extended attenuation
- Extended differential mode performance
- Available in three terminal configurations

EAS & EBS Models

- Same performance as EEA and EEB Series
- Snap-in mounting
- Spade terminals

EAH & EBH Models

- Same size as EEA and EEB
- Minimal leakage current suitable for medical applications
- Flange mounted
- Spade terminals

Specifications

Maximum leakage current each Line to Ground:

	<u>EEA/EEB</u>	<u>EAS/EBS</u>	<u>EAH/EBH</u>
@ 120 VAC 60 Hz:	.22 mA		2 μA
@ 250 VAC 50 Hz:	.38 mA		5 μA

Hipot rating (one minute):

Line to Ground:	2250 VDC
Line to Line:	1450 VDC

Rated Voltage (max.):

250 VAC

Operating Frequency:

50/60 Hz

Rated Current:

1 to 10A

Operating Ambient Temperature Range

(at rated current I_r): -10°C to +40°C

In an ambient temperature (T_a) higher than +40°C the maximum operating current (I_o) is calculated as follows: $I_o = I_r \sqrt{(85-T_a)/45}$

Electrical Schematic



Note 1: Not present in EAH / EBH versions

Cost-effective EMI Power Inlet Filter *(continued)*

EEA & EEB Series

Ordering Information



Available Part Numbers

EEA Models	EEB Models
1EEA1	1EEB1
1EEA2	1EEB2
1EEAP	1EEBP
3EEA1	3EEB1
3EEA2	3EEB2
3EEAP	3EEBP
6EEA1	6EEB1
6EEA2	6EEB2
6EEAP	6EEBP
10EEA1	10EEB1
10EEA2	10EEB2
10EEAP	10EEBP
EAS Models	EBS Models
1EAS1	1EBS1
3EAS1	3EBS1
6EAS1	6EBS1
10EAS1	10EBS1
EAH Models	EBH Models
1EAH1	1EBH1
3EAH1	3EBH1
6EAH1	6EBH1
10EAH1	10EBH1

Accessories

GA400: NEMA 5-15P to IEC 60320-1 C-13 line cord



FA601: Insulating Shroud



Cost-effective EMI Power Inlet Filter (continued)

EEA & EEB Series

Case Styles

EEA1, EEB1, EAH1 & EBH1



Typical Dimensions:
 Mounting holes (2): .132 [3.35] Dia. with .236 [5.99] Dia. x 90° countersink for #4 flathead screw IEC 60320-1 C14
 Line Inlet (1): IEC 60320-1 C14
 Load Terminals (2): .250 [6.3] with .07 [1.8] Dia. hole
 Ground Terminal (1): .250 [6.3] with .07 x .16 [1.8 x 3.8] slot

EEA2 & EEB2

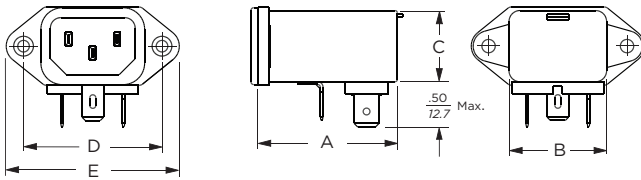

Typical Dimensions:
 Mounting holes (2): .132 [3.35] Dia. with .236 [5.99] Dia. x 90° countersink for #4 flathead screw IEC 60320-1 C14
 Line Inlet (1): IEC 60320-1 C14
 Load Terminals (2): .250 [6.3] with .07 [1.8] Dia. hole
 Ground Terminal (1): .250 [6.3] with .07 x .16 [1.8 x 3.8] slot

EEAP & EEBP



Typical Dimensions:
 Mounting holes (2): .132 [3.35] Dia. with .236 [5.99] Dia. x 90° countersink for #4 flathead screw IEC 60320-1 C14
 Line Inlet (1): IEC 60320-1 C14
 PC board pins (3): .031 [.07] square, ± .003 [.07]

EAS1 & EBS1



Typical Dimensions:
 Line Inlet (1): IEC 60320-1 C14
 Load Terminals (2): .250 [6.3] with .07 [1.8] Dia. hole
 Ground Terminal (1): .250 [6.3] with .07 x .16 [1.8 x 3.8] slot

Case Dimensions

Part No.	A (max.)	B (max.)	C (max.)	D $\pm .010$ $\pm .25$	E (max.)
EEA1, EEB1, EAH1, EBH1	2.15 54.6	1.12 28.4	0.81 20.6	1.575 40.01	1.98 50.3
EEA2, EEB2	1.54 39.1	1.12 28.4	0.81 20.6	1.575 40.01	1.98 50.3
EEAP, EEBP	1.54 39.1	1.12 28.4	0.81 20.6	1.575 40.01	1.98 50.3
EAS1, EBS1	2.20 55.88	1.15 29.2	.96 24.38	1.185 30.10	1.41 35.81

Recommended Panel Cutouts

EEA, EEB, EAH, EBH



Tolerances ± .005 [0.13] unless otherwise noted
 Note 1: EEA1, EEB1, EAH1, EBH1 can be front or back mounted
 Note 2: EEA2, EEB2, EEAP and EEBP can be back mounted only

EAS, EBS



PC Board Layout



Cost-effective EMI Power Inlet Filter *(continued)*

EEA & EEB Series

Performance Data

Typical Insertion Loss

Measured in closed 50 Ohm system

— Common Mode / Asymmetrical (L-G)
— Differential Mode / Symmetrical (L-L)

EEA, EAS Models

1A



3A



6A



10A



EEB, EBS Models

1A



3A



6A



10A



EAH Models

1A



3A



6A



10A



EBH Models

1A



3A



6A



10A



Cost-effective EMI Power Inlet Filter *(continued)*

EEA & EEB Series

Performance Data *(continued)*

Minimum Insertion Loss

Measured in closed 50 Ohm system

Common Mode / Asymmetrical (Line to Ground)

Current Rating	Frequency – MHz								
	.01	.05	.1	.15	.5	1	5	10	30
EEA / EAS Models									
1A	12	23	29	32	41	47	47	47	40
3A	-	10	15	19	30	36	48	50	47
6A	-	1	4	10	22	28	42	48	47
10A	-	1	3	5	14	20	32	38	47

EEB / EBS Models

1A	12	23	29	32	41	47	47	47	40
3A	-	10	14	18	30	36	48	50	47
6A	-	1	4	10	22	28	42	48	47
10A	-	1	3	5	14	20	32	38	47

EAH Models

1A	8	21	29	32	42	45	32	30	19
3A	-	5	10	15	25	27	30	27	22
6A	-	-	5	6	19	21	24	20	15
10A	-	-	1	5	9	12	12	12	12

EBH Models

1A	8	21	29	32	42	45	32	25	19
3A	-	5	10	15	25	27	30	27	22
6A	-	-	5	8	17	20	24	23	18
10A	-	-	-	3	8	12	12	12	12

Differential Mode / Symmetrical (Line to Line)

Current Rating	Frequency – MHz							
	.5	1	1.5	3	5	10	30	
EEA / EAS Models								
1A	1	9	19	32	42	45	40	
3A	2	4	6	20	35	45	40	
6A	2	4	6	6	24	40	40	
10A	1	4	5	5	5	30	40	

EEB / EBS Models

Current Rating	Frequency – MHz							
	.01	.15	.5	1	3	5	10	30
1A	1	3	14	23	41	47	50	44
3A	1	2	11	14	25	38	44	40
6A	1	2	10	14	20	33	42	40
10A	1	2	10	16	19	19	39	40

EAH Models

Current Rating	Frequency – MHz				
	1	1.5	5	10	30
1A	5	13	28	32	25
3A	4	6	20	27	28
6A	2	5	19	25	27
10A	1	5	15	22	27

EBH Models

Current Rating	Frequency – MHz				
	.15	.5	1	10	30
1A	1	10	18	30	31
3A	1	10	18	30	31
6A	1	10	18	30	31
10A	1	10	18	30	31

Cost-effective Medium Performance Power Inlet Filter

EEJ Series

Including the EJH/EJHS, EJM/EJMS and EJS Models



**UL Recognized
CSA Certified
VDE Approved***



EEJ Series

- Compact EMI filter with IEC 60320-1 C14 Inlet
- Enhanced two element circuit provides medium attenuation to 30MHz
- Compact and cost-effective design
- Supersedes most ED Series versions
- Includes 20A version with standard IEC 60320-1 C20 inlet
- Several termination styles
- Flanged mounting

EJS Models

- Same performance as the EEJ Series
- Snap-in mounting
- Several termination styles
- Includes 20A version with standard IEC 60320-1 C20 inlet

EJH & EJHS Models

- Minimal leakage current suitable for patient-contact medical applications
- Flanged mounting the same as the EEJ Series
- Also available in snap-in versions (EJHS)
- Two element circuit provides modest EMI attenuation above 1MHz
- Capacitive input (refer to the H Series for capacitive output)
- EJHS models feature snap-in mounting

EJM & EJMS Models

- Low leakage current, suitable for most medical applications
- Improved EMI attenuation up to 200MHz
- Mechanically the same as the EEJ Series with flange or snap-in mounting
- EJMS models feature snap-in mounting

Specifications

Maximum leakage current each Line to Ground:

	<u>EEJ/EJS</u>	<u>EJH</u>	<u>EJM</u>
@ 120 VAC 60 Hz:	.22 mA	2 µA	.01 mA
@250 VAC 50 Hz:	.38 mA	5 µA	.017 mA

Hipot rating (one minute):

Line to Ground:	2250 VDC
Line to Line:	1450 VDC

Rated Voltage (max.):

250 VAC

Operating Frequency:

50/60 Hz

Rated Current:

1 to 20A*

Operating Ambient Temperature Range

(at rated current I_r): -10°C to +40°C
In an ambient temperature (T_a) higher than +40°C the maximum operating current (I_o) is calculated as follows: $I_o = I_r \sqrt{(85-T_a)/45}$

Electrical Schematic



Note 1: Not present in EJH versions

**15A versions are tested by Underwriters Laboratories to US and Canadian requirements and are VDE approved at 10A, 250VAC*

20A versions are tested by Underwriters Laboratories to US and Canadian requirements and are VDE approved at 16A, 250VAC

Cost-effective Medium Performance Power Inlet Filter *(continued)*

EEJ Series

Including the EJH/EJHS, EJM/EJMS and EJS Models

Ordering Information

3 EEJ 1

Output Styles

- 1 - .250 [6.3] spade terminals
(back)
- 2 - .250 [6.3] spade terminals
(bottom)
- P - PC board pins
- 8 - Wire leads

Series

- EEJ - Enhanced EMI Inlet Filter
- EJS - EEJ in Snap-in Mounting
- EJH - Enhanced Medical Inlet Filter
- EJHS - EJH in Snap-in Mounting
- EJM - Extended Performance Medical Inlet Filter
- EJMS - EJM in Snap-in Mounting

Current Rating

- 1, 3, 6, 10, 15 or 20A

Accessories

GA400: NEMA 5-15P to IEC 60320-1 C-13 line cord

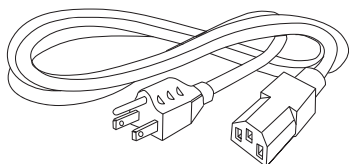

FA601: Insulating Shroud



Available Part Numbers

EEJ Models	EJH Models
1EEJ1	1EJH1
1EEJ2	1EJH2
1EEJP	1EJHP
1EEJ8	1EJH8
3EEJ1	3EJH1
3EEJ2	3EJH2
3EEJP	3EJHP
3EEJ8	3EJH8
6EEJ1	6EJH1
6EEJ2	6EJH2
6EEJP	6EJHP
6EEJ8	6EJH8
10EEJ1	10EJH1
10EEJ2	10EJH2
10EEJP	10EJHP
10EEJ8	10EJH8
15EEJ1	15EJH1
15EEJ2	15EJH2
15EEJP	15EJHP
15EEJ8	15EJH8
20EEJ1	20EJH1
20EEJ8	20EJH8
EJS Models	EJHS Models
1EJS1	1EJHS1
1EJS8	1EJHS8
3EJS1	3EJHS1
3EJS8	3EJHS8
6EJS1	6EJHS1
6EJS8	6EJHS8
10EJS1	10EJHS1
10EJS8	10EJHS8
15EJS1	15EJHS1
15EJS8	15EJHS8
20EJS1	
20EJS8	
EJM Models	EJMS Models
1EJM1	1EJMS1
1EJM8	1EJMS8
3EJM1	3EJMS1
3EJM8	3EJMS8
6EJM1	6EJMS1
6EJM8	6EJMS8
10EJM1	10EJMS1
10EJM8	10EJMS8
15EJM1	15EJMS1
15EJM8	15EJMS8

Cost-effective Medium Performance Power Inlet Filter *(continued)*

EEJ Series

 Including the EJH/EJHS, EJM/EJMS and EJS Models

Case Styles

EEJ1, EJH1 & EJM1 (1-15A)



Typical Dimensions:
 Mounting holes (2): .132 [3.35] Dia. with .236 [5.99] Dia. x 90° countersink for #4 flathead screw
 Line Inlet (1): IEC 60320-1 C14
 Load Terminals (2): .250 [6.3] with .07 [1.8] Dia. hole
 Ground Terminal (1): .250 [6.3] with .07 x .16 [1.8 x 3.8] slot

EEJ2 & EJH2 (1-15A)



Typical Dimensions:
 Mounting holes (2): .132 [3.35] Dia. with .236 [5.99] Dia. x 90° countersink for #4 flathead screw
 Line Inlet (1): IEC 60320-1 C14
 Load Terminals (2): .250 [6.3] with .07 [1.8] Dia. hole
 Ground Terminal (1): .250 [6.3] with .07 x .16 [1.8 x 3.8] slot

EEJP & EJHP (1-15A)



Typical Dimensions:
 Mounting holes (2): .132 [3.35] Dia. with .236 [5.99] Dia. x 90° countersink for #4 flathead screw
 Line Inlet (1): IEC 60320-1 C14
 PC board pins (3): .031 [.07] square, ± .003 [.07]

EJS1, EJHS1 & EJMS1 (1-15A)



Typical Dimensions:
 Line Inlet (1): IEC 60320-1 C14
 Load Terminals (2): .250 [6.3] with .07 [1.8] Dia. hole
 Ground Terminal (1): .250 [6.3] with .07 x .16 [1.8 x 3.8] slot

EEJ8, EJH8 & EJM8 (1-15A)



Typical Dimensions:
 Mounting holes (2): .132 [3.35] Dia. with .236 [5.99] Dia. x 90° countersink for #4 flathead screw
 Line Inlet (1): IEC 60320-1 C14
 Wire Leads: 4.0 [101.6] Min., 18AWG, UL1015

EJS8, EJHS8 & EJMS8 (1-15A)



Typical Dimensions:
 Line Inlet (1): IEC 60320-1 C14
 Wire Leads: 4.0 [101.6] Min., 18AWG, UL1015

20EEJ1 & 20EJH1



Typical Dimensions:
 Mounting holes (2): .132 [3.35] Dia. with .236 [5.99] Dia. x 90° countersink for #4 flathead screw
 Line Inlet (1): IEC 60320-1 C20
 Load Terminals (2): .250 [6.3] with .07 [1.8] Dia. hole
 Ground Terminal (1): .250 [6.3] with .07 x .16 [1.8 x 3.8] slot

Cost-effective Medium Performance Power Inlet Filter *(continued)*

EEJ Series

 Including the EJH/EJHS, EJM/EJMS and EJS Models

Case Styles *(continued)*

20EJS1



Typical Dimensions:

Line Inlet (1):	IEC 60320-1 C20
Load Terminals (2):	.250 [6.3] with .07 [1.8] Dia. hole
Ground Terminal (1):	.250 [6.3] with .07 x .16 [1.8 x 3.8] slot

20EEJ8 & 20EJH8



Typical Dimensions:

Mounting holes (2):	.132 [3.35] Dia. with .236 [5.99] Dia. x 90° countersink for #4 flathead screw
Line Inlet (1):	IEC 60320-1 C20
Wire Leads:	4.0 [101.6] Min., 14AWG, UL1015

20EJS8



Typical Dimensions:

Line Inlet (1):	IEC 60320-1 C20
Wire Leads:	4.0 [101.6] Min., 14AWG, UL1015

Recommended Panel Cutouts

1 to 15A EEJ, EJH & EJM



Tolerances ± .005 [0.13] unless otherwise noted

- Note 1: EEJ/EJH/EJM1 and EEJ/EJH/EJM8 can be front or back mounted
 Note 2: EEJ/EJH2 and EEJ/EJHP can be back mounted only

20A EEJ & EJH



Tolerances ± .005 [0.13] unless otherwise noted

- Note 1: 20EEJ/EJH1 and 20EEJ/EJH8 can be front or back mounted

1 to 15A EJHS, EJMS & EJS



Tolerance ± .002 [0.050]

Alternate snap configurations to fit other cut-out sizes also available.
 Contact TE's Corcom product engineering group for more details.

20A EJS



Tolerance ± .002 [0.050]

PC Board Layout



Cost-effective Medium Performance Power Inlet Filter *(continued)*

EEJ Series

Including the EJH/EJHS, EJM/EJMS and EJS Models

Case Dimensions

Part No.	A (max.)	B (max.)	C (max.)	D ± 0.15 $\pm .38$	E (max.)	F (ref.)
EEJ1, EJH1	2.15 <i>54.61</i>	1.13 <i>28.70</i>	0.96 <i>24.38</i>	1.580 <i>40.00</i>	2.04 <i>51.76</i>	-
EJM1	2.02 <i>51.3</i>	1.13 <i>28.7</i>	0.96 <i>24.4</i>	1.58 <i>40.00</i>	2.04 <i>51.8</i>	-
1-10A	1.54	1.13	0.96	1.580	2.04	-
EEJ2, EJH2	39.12	28.70	24.38	40.00	51.76	-
15A	1.79	1.13	0.96	1.580	2.04	-
EEJ2, EJH2	45.47	28.70	24.38	40.00	51.76	-
1-10A	1.54	1.13	0.96	1.580	2.04	-
EEJP, EJHP	39.12	28.70	24.38	40.00	51.76	-
15A	1.79	1.13	0.96	1.580	2.04	-
EEJP, EJHP	45.47	28.70	24.38	40.00	51.76	-
EJS1, EJHS1	2.20 <i>55.88</i>	1.13 <i>28.70</i>	0.96 <i>24.38</i>	1.19 <i>30.10</i>	1.41 <i>35.81</i>	-
EJMS1	2.02 <i>51.3</i>	1.13 <i>28.7</i>	0.96 <i>24.4</i>	-	1.41 <i>35.8</i>	-
EEJ8, EJH8	1.54 <i>39.12</i>	1.13 <i>28.70</i>	0.81 <i>20.70</i>	1.58 <i>40.00</i>	2.04 <i>51.76</i>	-
EJM8	1.50 <i>38.1</i>	1.13 <i>28.7</i>	0.81 <i>20.7</i>	1.58 <i>40.00</i>	2.04 <i>51.8</i>	-
EJS8, EJHS8	1.54 <i>39.12</i>	1.13 <i>28.70</i>	0.81 <i>20.70</i>	1.19 <i>30.10</i>	1.41 <i>35.81</i>	-
EJMS8	1.50 <i>38.1</i>	1.13 <i>28.7</i>	0.96 <i>24.4</i>	-	1.41 <i>35.8</i>	-
20EEJ1, 20EJH1	3.13 <i>79.38</i>	1.37 <i>34.79</i>	1.18 <i>29.99</i>	1.65 <i>42.01</i>	2.09 <i>53.00</i>	-
20EJS1	3.13 <i>79.38</i>	1.35 <i>34.29</i>	1.18 <i>29.99</i>	1.42 <i>36.07</i>	1.46 <i>37.08</i>	-
20EEJ8, 20EJH8	2.65 <i>67.31</i>	1.35 <i>34.29</i>	1.18 <i>29.99</i>	1.65 <i>42.01</i>	2.09 <i>53.00</i>	.62 <i>15.75</i>
20EJS8	2.63 <i>66.80</i>	1.35 <i>34.29</i>	1.18 <i>29.97</i>	1.46 <i>37.08</i>	1.42 <i>36.08</i>	.62 <i>15.75</i>



Performance Data

Typical Insertion Loss

Measured in closed 50 Ohm system

EEJ & EJS Models

1A



3A



6A



10A



15A



20A



— Common Mode / Asymmetrical (L-G)
- - - Differential Mode / Symmetrical (L-L)

Cost-effective Medium Performance Power Inlet Filter *(continued)*

EEJ Series

Including the EJH/EJHS, EJM/EJMS and EJS Models

Performance Data *(continued)*

Typical Insertion Loss

Measured in closed 50 Ohm system

EJH & EJHS Models

1A



3A



6A



10A



15A



20A



EJM & EJMS Models

1A



3A



6A



10A



15A



— Common Mode / Asymmetrical (L-G)
— Differential Mode / Symmetrical (L-L)

Cost-effective Medium Performance Power Inlet Filter *(continued)*

EEJ Series

Including the EJH/EJHS, EJM/EJMS and EJS Models

Minimum Insertion Loss

Measured in closed 50 Ohm system

Common Mode / Asymmetrical (Line to Ground)

Current Rating	Frequency – MHz								
	.01	.05	.1	.15	.5	1	5	10	30
EEJ / EJS Models									
1A	15	27	29	32	41	47	47	47	40
3A	-	10	15	20	30	39	48	50	60
6A	-	1	5	9	21	28	41	44	54
10A	-	1	4	7	14	18	31	36	51
15A	-	-	-	2	5	8	21	26	42
20A	-	-	3	5	14	21	30	33	42
EJH Models									
1A	13	26	33	36	41	41	31	26	18
3A	-	9	15	19	27	31	30	26	20
6A	-	2	6	9	20	22	31	20	18
10A	-	1	4	7	12	17	19	18	18
15A	-	-	1	2	3	3	4	2	2
20A	-	-	3	5	14	16	12	11	11

Differential Mode / Symmetrical (Line to Line)

Current Rating	Frequency – MHz										
	.01	.05	.1	.15	.5	1	5	10	30	EEJ	EJS
EEJ / EJS Models											
1A	-	-	5	8	19	27	45	43	40	9	
3A	-	-	5	8	17	20	39	42	40	11	
6A	-	-	5	8	17	21	32	40	40	16	
10A	-	-	5	8	17	21	23	36	38	16	
15A	-	-	5	8	17	23	33	30	38	11	
20A	-	-	5	2	17	25	38	48	48	48	
EJH Models											
1A	13	26	33	36	41	41	31	26	18		
3A	-	9	15	19	27	31	30	26	20		
6A	-	2	6	9	20	22	31	20	18		
10A	-	1	4	7	12	17	19	18	18		
15A	-	-	1	2	3	3	4	2	2		
20A	-	-	3	5	14	16	12	11	11		

EJM & EJMS Models

Current Rating	Frequency – MHz								
	.05	.5	1	10	20	30	80	150	200
1A	25	41	37	18	15	13	15	14	7
3A	6	27	30	21	19	19	23	13	7
6A	2	17	20	17	17	14	23	13	7
10A	1.5	11	12	9	8	9	20	19	12
15A	0.5	2	3	4	2	10	12	17	11

Current Rating	Frequency – MHz								
	.05	.5	1	10	20	30	80	150	200
1A	1.5	21	28	34	36	29	27	34	28
3A	1.5	17	23	29	31	37	33	32	28
6A	1.5	16	22	28	29	34	37	37	32
10A	2	16	22	28	24	18	27	32	30
15A	1.5	17	23	35	34	29	27	29	25



EMI Power Inlet Filter

EF Series



UL Recognized
CSA Certified
VDE Approved*



EF Series

- Compact single stage EMI filter with IEC 60320-1 C14 inlet
- Two element circuit provides basic attenuation
- Available with an internal ground-circuit inductor (C suffix versions) to isolate equipment chassis from power line ground at radio frequencies
- Superseded by the EEA Series

Ordering Information



Available Part Numbers

1EF1F	1EF2F	1EF4	1EF8
3EF1F	3EF2F	3EF4	3EF8
6EF1F	6EF2F	6EF4	6EF8
10EF1F			
15EF1F			
Ground Circuit Inductor Versions			
10EF1FC			

Specifications

Maximum leakage current each Line to Ground:

@ 120 VAC 60 Hz:	.21 mA
@ 250 VAC 50 Hz:	.36 mA

Hipot rating (one minute):

Line to Ground:	2250 VDC
Line to Line:	1450 VDC

Rated Voltage (max.):

250 VAC

Operating Frequency:

50/60 Hz

Rated Current:

1 to 15A*

Operating Ambient Temperature Range

(at rated current I_r): -10°C to +40°C
In an ambient temperature (T_a) higher than +40°C the maximum operating current (I_o) is calculated as follows: $I_o = I_r \sqrt{(85-T_a)/45}$

Accessories

GA400: NEMA 5-15P to IEC 60320-1 C-13 line cord



FA601: Insulating Shroud



*15A versions are tested by Underwriters Laboratories to US and Canadian requirements and are VDE approved at 10A, 250VAC

EMI Power Inlet Filter (continued)

EF Series

Electrical Schematic



Note 1: C Suffix (ground choke) versions only

Case Styles

EF1F & EF1FC



Typical Dimensions:

Line Inlet (1): IEC 60320-1 C14
Load Terminals (2): .250 [6.3] with .07 [1.8] Dia. hole
Ground Terminal (1): .250 [6.3] with .07 x .16 [1.8 x 3.8] slot

EF2F



Typical Dimensions:

Line Inlet (1): IEC 60320-1 C14
Load Terminals (2): .250 [6.3] with .07 [1.8] Dia. hole
Ground Terminal (1): .250 [6.3] with .07 x .16 [1.8 x 3.8] slot

EF4



Typical Dimensions:

Line Inlet (1): IEC 60320-1 C14
Wire Leads: 4.0 [101.6] Min., 18AWG, UL1015

EF8



Typical Dimensions:

Line Inlet (1): IEC 60320-1 C14
Wire Leads: 4.0 [101.6] Min., 18AWG, UL1015

Case Dimensions

Part No.	A (max.)	B (max.)	C (max.)	D $\pm .015$ $\pm .38$	E (max.)	F (ref.)
1EF1F, 3EF1F, 6EF1F	2.21	1.19	0.81	1.575	1.98	-
1EF2F, 3EF2F, 6EF2F	1.55	1.19	0.85	1.575	1.98	-
1EF4, 3EF4, 6EF4	1.55	1.19	0.85	1.575	1.98	.295
1EF8, 3EF8, 6EF8	1.55	1.19	0.81	1.575	1.98	.295
10EF1F, 10EF1FC	2.62	1.19	0.81	1.575	1.98	-
15EF1F	2.62	1.19	0.81	1.575	1.98	-

Recommended Panel Cutouts



Tolerances $\pm .005$ [0.13] unless otherwise noted

Note 1: EF1F, EF1FC and EF8 allow for front or back mounting
Note 2: EF2F and EF4 allow for back mounting only

EMI Power Inlet Filter *(continued)*

EF Series

Performance Data

Typical Insertion Loss

Measured in closed 50 Ohm system

1EF



3EF



6EF



10EF



15EF



— Common Mode / Asymmetrical (L-G)
— Differential Mode / Symmetrical (L-L)

Minimum Insertion Loss

Measured in closed 50 Ohm system

Common Mode / Asymmetrical (Line to Ground)

Current Rating	Frequency – MHz					
	.15	.5	1	5	10	30
EF1F, EF2F						
1A	22	35	40	46	50	49
3A	15	25	30	45	50	54
6A	9	20	25	41	45	50
10A	8	15	20	34	39	44
15A	-	6	12	20	25	25
EF4, EF8						
1A	22	35	40	46	50	49
3A	15	25	30	45	50	54
6A	9	20	25	41	45	47
EF1FC						
10A	8	15	20	34	39	44

High Performance Power Inlet Filter

EJT Series



UL Recognized
CSA Certified
VDE Approved*



EJT Series

- Superior EMI filter with IEC 60320-1 inlet
- Double three element differential mode circuit attenuates noise up to 1GHz
- Up to 15A with IEC 60320-1 C14 inlet
- 20A rating with IEC 60320-1 C20 inlet
- Spade terminals or wire leads

Ordering Information



Available Part Numbers

1EJT1	1EJT8
3EJT1	3EJT8
6EJT1	6EJT8
10EJT1	10EJT8
15EJT1	15EJT8
20EJT1	20EJT8

**15A versions are tested by Underwriters Laboratories to US and Canadian requirements and are VDE approved at 10A, 250VAC.
20A versions are tested by Underwriters Laboratories to US and Canadian requirements and are VDE approved at 16A, 250VAC.*

Specifications

Maximum leakage current each Line to Ground:

	<u>1-15A</u>	<u>20A</u>
@ 120 VAC 60 Hz:	.25 mA	.22 mA
@ 250 VAC 50 Hz:	.43 mA	.40 mA

Hipot rating (one minute):

Line to Ground:	2250 VDC
Line to Line:	1450 VDC

Rated Voltage (max.): 250 VAC

Operating Frequency: 50/60 Hz

Rated Current: 1 to 20A*

Operating Ambient Temperature Range

(at rated current I_r): -10°C to +40°C
In an ambient temperature (T_a) higher than +40°C the maximum operating current (I_o) is calculated as follows: $I_o = I_r \sqrt{(85-T_a)/45}$

Accessories

GA400: NEMA 5-15P to IEC 60320-1 C-13 line cord



FA601: Insulating Shroud (*fits 1-15A only*)



High Performance Power Inlet Filter *(continued)*

EJT Series

Electrical Schematics



Note 1: 20A versions only

Case Styles

EJT1



Typical Dimensions:
 Mounting holes (2): .132 [3.35] Dia. with .236 [5.99] Dia. x 90° countersink for #4 flathead screw IEC 60320-1 C14
 Line Inlet (1): IEC 60320-1 C20
 Load Terminals (2): .250 [6.3] with .07 [1.8] Dia. hole
 Ground Terminal (1): .250 [6.3] with .07 x .16 [1.8 x 3.8] slot

20EJT1



Typical Dimensions:
 Mounting holes (2): .126 [3.20] Dia. with .236 [5.99] Dia. x 90° countersink for #4 flathead screw IEC 60320-1 C20
 Line Inlet (1): IEC 60320-1 C20
 Load Terminals (2): .250 [6.3] with .07 [1.8] Dia. hole
 Ground Terminal (1): .250 [6.3] with .07 x .16 [1.8 x 3.8] slot

EJT8



Typical Dimensions:
 Mounting holes (2): .132 [3.35] Dia. with .236 [5.99] Dia. x 90° countersink for #4 flathead screw IEC 60320-1 C14
 Line Inlet (1): IEC 60320-1 C14
 Wire Leads: 4.0 [101.6] Min., 18AWG, UL1015

20EJT8



Typical Dimensions:
 Mounting holes (2): .126 [3.20] Dia. with .236 [5.99] Dia. x 90° countersink for #4 flathead screw IEC 60320-1 C20
 Line Inlet (1): IEC 60320-1 C20
 Wire Leads: 4.0 [101.6] Min., 14AWG, UL1015

Case Dimensions

Part No.	A (max.)	B (max.)	C (max.)	D (max.)	E (max.)
EJT1	2.74 69.6	1.19 30.2	0.875 22.2	1.575 40.0	1.98 50.3
EJT8	2.1 53.3	1.19 30.2	0.875 22.2	1.575 40.0	1.98 50.3
20EJT1	3.8 96.52	1.350 34.29	1.18 29.99	1.654 42.01	2.087 53.00
20EJT8	3.2 81.28	1.350 34.29	1.18 29.99	1.654 42.01	2.087 53.00

Recommended Panel Cutouts



High Performance Power Inlet Filter *(continued)*

EJT Series

Performance Data

Typical Insertion Loss

Measured in closed 50 Ohm system

1EJT



3EJT



6EJT



10EJT

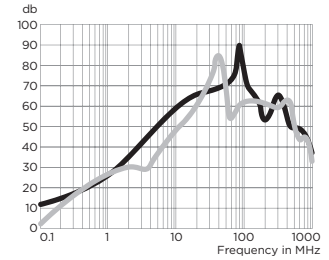

15EJT



20EJT



— Common Mode / Asymmetrical (L-G)
- - - Differential Mode / Symmetrical (L-L)

Minimum Insertion Loss

Measured in closed 50 Ohm system

Common Mode / Asymmetrical (Line to Ground)

Current Rating	Frequency – MHz							
	.15	.5	1	5	10	30	100	1000
1A	27	33	40	59	65	65	61	14
3A	22	30	34	57	63	69	61	10
6A	13	21	27	51	60	65	59	14
10A	7	14	21	43	52	61	61	14
15A	4	10	15	38	48	63	63	14
20A	-	8	15	42	50	60	58	14

Differential Mode / Symmetrical (Line to Line)

Current Rating	Frequency – MHz							
	.15	.5	1	5	10	30	100	1000
1A	10	20	23	43	52	65	45	14
3A	10	20	24	41	51	59	52	17
6A	10	21	24	37	48	65	55	20
10A	10	21	25	28	44	63	53	18
15A	10	20	26	25	36	56	45	23
20A	9	20	26	40	35	48	50	10

Smallest Power Entry Module with Metric Fuse Holders

GG & HG Series



UL Recognized
CSA Certified
VDE Approved



GG Series

- Power entry module with enhanced EMI filter
- Single or dual fusing
- Two element circuit provides basic attenuation
- Available with an internal ground-circuit inductor (C versions) to isolate equipment chassis from power line ground at radio frequencies
- Multiple termination and mounting styles

HG Series

- Medical version of our GG Series
- Mechanically identical to GG Series
- Available only with dual fusing

Ordering Information



Specifications

Maximum leakage current each Line to Ground:

	HG Models	GG Models
@ 120 VAC 60 Hz:	2 μ A	.25 mA
@250 VAC 50 Hz:	5 μ A	.42 mA

Hipot rating (one minute):

Line to Ground:	2250 VDC
Line to Line:	1450 VDC

Rated Voltage (max.): 250 VAC

Operating Frequency: 50/60 Hz

Rated Current: 1 to 10A

Required Fuse(s): 5 x 20mm
(not included)

Available Part Numbers

Filtered modules			
1EGG1-1	3EGG1-1	6EGG1-1	10EGG1-1
1EGG1-2	3EGG1-2	6EGG1-2	10EGG1-2
1EGG8-1	3EGG8-1	6EGG8-1	10EGG8-1
1EGG8-2	3EGG8-2	6EGG8-2	10EGG8-2
1EGS1-1	3EGS1-1	6EGS1-1	10EGS1-1
1EGS1-2	3EGS1-2	6EGS1-2	10EGS1-2
Filtered modules with ground circuit inductor			
1EGG1C-1	3EGG1C-1	6EGG1C-1	
1EGG1C-2	3EGG1C-2	6EGG1C-2	
1EGG8C-1	3EGG8C-1	6EGG8C-1	
1EGG8C-2	3EGG8C-2	6EGG8C-2	
Medical filter modules			
1EHG1-2	3EHG1-2	6EHG1-2	10EHG1-2
1EHG8-2	3EHG8-2	6EHG8-2	10EHG8-2
1EHGS1-2	3EHGS1-2	6EHGS1-2	10EHGS1-2

Smallest Power Entry Module with Metric Fuse Holders *(continued)*

GG & HG Series

Electrical Schematic



Note 1: Second fuse only in -2 version
Note 2: C versions only
Note 3: Not present in HG versions

Warning: Do not attempt to operate a single-fused model without the fuse door in place.

Accessories

GA400: NEMA 5-15P to IEC 60320-1 C-13 line cord



Case Styles

GG1, GG1C & HG1

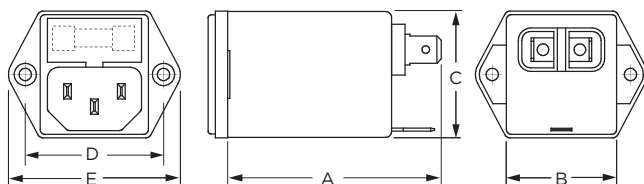

Typical Dimensions:
Mounting holes (2): .132 [3.35] Dia. with .236 [5.99] Dia. x 90°
countersink for #4 flathead screw
Line Inlet (1): IEC 60320-1 C14
Load Terminals (2): .250 [6.3] with .07 [1.8] Dia. hole
Ground Terminal (1): .250 [6.3] with .07 x .16 [1.8 x 3.8] slot

GS1 & HGS1



Typical Dimensions:
Line Inlet (1): IEC 60320-1 C14
Load Terminals (2): .250 [6.3] with .07 [1.8] Dia. hole
Ground Terminal (1): .250 [6.3] with .07 x .16 [1.8 x 3.8] slot

GG8 & HG8



Typical Dimensions:
Mounting holes (2): .132 [3.35] Dia. with .236 [5.99] Dia. x 90°
countersink for #4 flathead screw
Line Inlet (1): IEC 60320-1 C14
Wire Leads: 5.0 [127.0] Min., 18AWG, UL1015

Case Dimensions

Part No.	A (max.)	B (max.)	C (max.)	D $\pm .015$ $\pm .38$	E (max.)
GG1 & HG1	2.13 <i>54.5</i>	1.13 <i>28.7</i>	1.29 <i>32.8</i>	1.417 <i>36.0</i>	1.76 <i>44.7</i>
GG1C	2.45 <i>62.23</i>	1.13 <i>28.7</i>	1.28 <i>32.5</i>	1.417 <i>36.0</i>	1.76 <i>44.7</i>
GS1, HGS1	2.13 <i>54.0</i>	1.13 <i>28.7</i>	1.28 <i>32.5</i>	1.46* <i>36.0*</i>	1.42 <i>36.1</i>
GG8, HG8	2.02 <i>51.1</i>	1.13 <i>28.7</i>	1.29 <i>32.8</i>	1.417 <i>36.0</i>	1.76 <i>44.7</i>

*max. dimension

Recommended Panel Cutouts

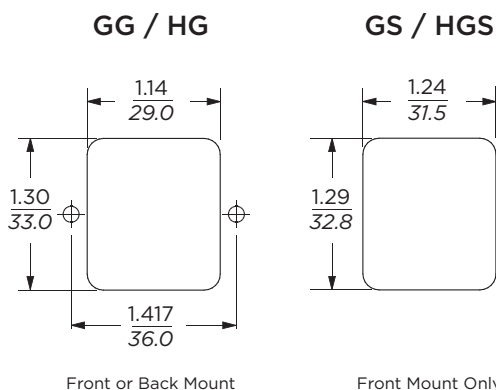

Typical Dimensions:
GS / HGS panel thickness: 0.032 – 0.080 [0.81 – 2.03]
Corner radius: 0.138 [0.35]

Smallest Power Entry Module with Metric Fuse Holders *(continued)*

GG & HG Series

Performance Data

Typical Insertion Loss Measured in closed 50 Ohm system

GG & GS Models

1A



3A



6A



10A



3A GGIC



6A GGIC



— Common Mode / Asymmetrical (L-G)
— Differential Mode / Symmetrical (L-L)

HG Models

1A



3A



6A



10A



Minimum Insertion Loss Measured in closed 50 Ohm system

Common Mode / Asymmetrical (Line to Ground)

Current Rating	Frequency – MHz								
	.01	.05	.10	.15	.5	1	5	10	30
GG & GS Models									
1A	12	23	29	32	41	47	50	50	55
3A	-	10	15	19	30	36	48	50	53
6A	-	1	4	10	16	22	36	40	50
10A	-	1	2	4	6	8	26	33	28
HG Models									
1A	12	23	29	32	40	40	28	22	18
3A	-	10	15	19	25	26	22	21	21
6A	-	4	10	14	18	18	14	14	14
10A	1	-	-	3	5	6	8	9	10

Differential Mode / Symmetrical (Line to Line)

Current Rating	Frequency – MHz							
	.10	.15	.5	1	3	5	10	30
GG & GS Models								
1A	1	3	14	23	41	47	50	44
3A	1	2	11	14	25	38	44	40
6A	1	2	10	13	23	33	39	42
10A	4	7	17	23	-	22	43	38
HG Models								
1A	2	6	19	26	30	35	35	20
3A	1	7	16	23	30	30	30	30
6A	4	7	16	23	30	30	30	30
10A	-	8	16	22	-	37	43	28

Power Inlet Line Filter for Medical Equipment

H Series



UL Recognized
CSA Certified
VDE Approved*



H Series

- Minimal leakage current suitable for medical equipment
- Two element circuit provides basic EMI attenuation above 1 MHz
- Available with an internal ground circuit inductor (C suffix versions) to isolate equipment chassis from power line ground at radio frequencies
- Flanged mounting the same as the EC, ED and EF Series
- Capacitive output (see EAH, EBH and EJH Series for capacitive input)

Ordering Information



*IEC 60320-1 C14 inlet mates with C13 connector

Specifications

Maximum leakage current each Line to Ground:

@ 120 VAC 60 Hz:	2 µA
@ 250 VAC 50 Hz:	5 µA

Hipot rating (one minute):

Line to Ground:	2250 VDC
Line to Line:	1450 VDC

Rated Voltage (max.):

250 VAC

Operating Frequency:

50/60 Hz

Rated Current:

3 to 15A*

Operating Ambient Temperature Range

(at rated current I_r): -10°C to +40°C

In an ambient temperature (T_a) higher than +40°C the maximum operating current (I_o) is calculated as follows: $I_o = I_r \sqrt{(85-T_a)/45}$

Electrical Schematic

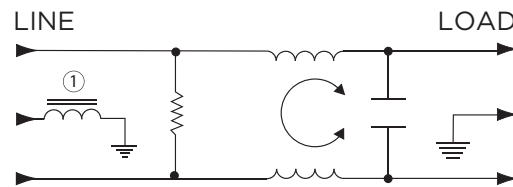

Available Part Numbers

3EH1	6EH8
3EH3	6EH9
6EH1	10EH1
6EH3	10EH3
6EH4	10EH4
6EH5	15EH4
Ground Circuit Inductor Versions	
10EH4C	

*15A versions are tested by Underwriters Laboratories to US and Canadian requirements and are VDE approved at 10A, 250VAC

Power Inlet Line Filter for Medical Equipment *(continued)*

H Series

Case Styles

H1 (Chassis Mount)



Typical Dimensions:
 Mounting Holes: .188 [4.78] Dia.
 Line / Load Terminals (4): .250 [6.3] with .07 [1.8] Dia. hole
 Ground Terminal (1): .250 [6.3] with .07 x .16 [1.8 x 3.8] slot

H3 (Chassis Mount)



Typical Dimensions:
 Mounting Holes: .188 [4.78] Dia.
 Wire Leads(5): 4.0 [101.6] Min., 18AWG, UL1015

H4 & H4C



Typical Dimensions:
 Line Inlet (1): IEC 60320-1 C14
 Load Terminals (2): .250 [6.3] with .07 [1.8] Dia. hole
 Ground Terminal (1): .250 [6.3] with .07 x .16 [1.8 x 3.8] slot

H9



Typical Dimensions:
 Line Inlet (1): IEC 60320-1 C14
 Load Terminals (2): .250 [6.3] with .07 [1.8] Dia. hole
 Ground Terminal (1): .250 [6.3] with .07 x .16 [1.8 x 3.8] slot

H5



Typical Dimensions:
 Line Inlet (1): IEC 60320-1 C14
 Wire Leads: 4.0 [101.6] Min., 18AWG, UL1015

H8



Typical Dimensions:
 Line Inlet (1): IEC 60320-1 C14
 Wire Leads: 4.0 [101.6] Min., 18AWG, UL1015

Recommended Panel Cutouts



Note 1: H4, H4C and H8 allow for front or back mounting
 Note 2: H5 and H9 allow for back mounting only

Power Inlet Line Filter for Medical Equipment *(continued)*

H Series

Case Dimensions

Part No.	A (max.)	B (max.)	C (max.)	D $\pm .015$ $\pm .38$	E (max.)	F (ref.)
H1	2.25 <i>57.2</i>	1.82 <i>46.1</i>	0.66 <i>16.7</i>	2.125 <i>53.98</i>	2.53 <i>64.2</i>	-
H3	.96 <i>24.40</i>	1.82 <i>46.1</i>	0.66 <i>16.7</i>	2.125 <i>53.98</i>	2.53 <i>64.2</i>	-
6EH4	2.20 <i>55.9</i>	1.19 <i>30.2</i>	0.81 <i>20.6</i>	1.575 <i>40.01</i>	1.98 <i>50.3</i>	-
10EH4, 10EH4C	2.62 <i>66.5</i>	1.19 <i>30.2</i>	0.81 <i>20.6</i>	1.575 <i>40.01</i>	1.98 <i>50.3</i>	-
15EH4	2.62 <i>66.5</i>	1.19 <i>30.2</i>	0.81 <i>20.6</i>	1.575 <i>40.01</i>	1.98 <i>50.3</i>	-
H5	1.55 <i>39.4</i>	1.19 <i>30.2</i>	0.85 <i>21.6</i>	1.575 <i>40.01</i>	1.98 <i>50.3</i>	.295 <i>7.5</i>
H8	1.56 <i>39.7</i>	1.19 <i>30.2</i>	0.81 <i>20.6</i>	1.575 <i>40.01</i>	1.98 <i>50.3</i>	.295 <i>7.5</i>
H9	1.55 <i>39.4</i>	1.19 <i>30.2</i>	0.85 <i>21.6</i>	1.575 <i>40.01</i>	1.98 <i>50.3</i>	-

Accessories

GA400: NEMA 5-15P to IEC 60320-1 C-13 line cord



FA601: Insulating Shroud



Performance Data

Typical Insertion Loss

Measured in closed 50 Ohm system

3EH



6EH



10EH



15EH



— Common Mode / Asymmetrical (L-G)
— Differential Mode / Symmetrical (L-L)

Minimum Insertion Loss

Measured in closed 50 Ohm system

Common Mode / Asymmetrical (Line to Ground)

Current Rating	Frequency – MHz					
	.15	.5	1	5	10	30
3A	18	27	30	30	27	18
6A	9	16	20	26	23	18
10A	7	13	15	17	16	14
15A	5	9	11	12	11	9

Power Entry Module with Voltage Selection and Fusing

J Series



UL Recognized
CSA Certified



J Series

- Power entry module with North American style 3AG fuse holder
- 2 or 4 voltage selection
- Compact snap-in design
- Two element circuit provides basic EMI attenuation
- Available with minimal leakage current suitable for medical applications (HJ models)
- Also available without filter (VJ models)

Ordering Information



Specifications

Maximum leakage current each Line to Ground:

	6J4 Models	6HJ4 or non-filtered
@250 VAC 50 Hz:	500 μ A	5 μ A

Hipot rating (one minute):

Line to Ground:	1550 VAC
Line to Line:	1450 VDC

Operating Voltage:

suffix - 1 or - 4 models:	100, 120, 220 or 240VAC
suffix - 2 models:	115 or 230 VAC

Operating Frequency:

50/60 Hz

Rated Current:

6A

Required Fuse:

.25 x 1.25
(not included)

Available Part Numbers

Non-filtered models	
6VJ1	6VJ1-2
General Purpose Filters	
6J4	6J4-2
Medical Filters	
6HJ4-4	6HJ4-2

Power Entry Module with Voltage Selection and Fusing *(continued)*

J Series

Electrical Schematics

6VJ1 & 6VJ1-2



6J4 & 6J4-2



6HJ4-4 & 6J4-2



- Note 1: Jumper required if only SPST power switch is used
- Note 2: Jumpers required if no input filtering is used
- Note 3: Use only 120V and 240V positions for 2 volt selection units

Voltage Selection

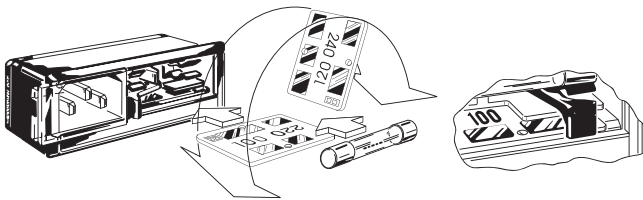

Open cover door and slide fuse-pull lever to left. Select operating voltage by orienting voltage selection card with the desired voltage on top left side. Push card firmly into module slot. Slide fuse-pull lever to right into normal position and re-insert fuse into holders.

Use caution in selecting correct fuse value.

Accessories

GA400: NEMA 5-15P to IEC 60320-1 C-13 line cord

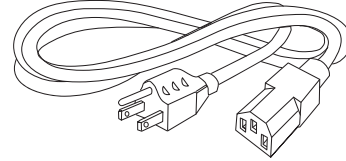

JA302: 2 Voltage Select Card

Comes standard with 6VJ1-2, 6J4-2 and 6HJ4-2

JA304: 4 Voltage Select Card

Comes standard with 6VJ1, 6J4 and 6HJ4-4

JA403: Mounting clips for .105 - .125" panels

JA410-419: Equipment Rating Labels

Self-adhesive, available in multiples of 40
Specify part number

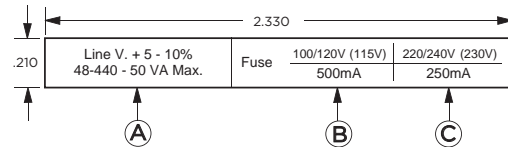

Part No.	A	B	C
	VA max.	Fuse	Fuse
JA410	25	100/120 (115V)	220/240 (230V)
JA411	50	500mA	250mA
JA412	100	1A	500 mA
JA413	200	2A	1A
JA414	250	2.5A	1.25A
JA415	300	3A	1.5A
JA416	400	4 A	2A
JA417	500	5A	2.5A
JA418	600	6A	3A
JA419	Assortment		

JA410-JA418: 40 labels of one part number

JA419: 5 each of JA410 - JA418 (45 labels)

JA500: Voltage Selector Card Extractor Tool

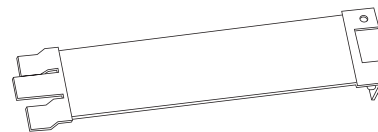

Power Entry Module with Voltage Selection and Fusing *(continued)*

J Series

Case Styles

Non-filtered Models

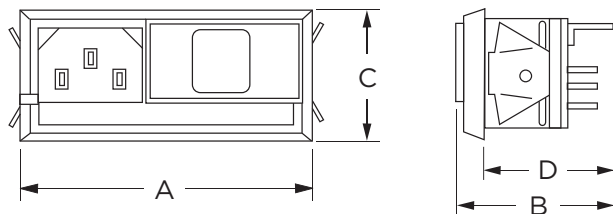

Typical Dimensions:
Line Inlet (1): IEC 60320-1 C14
Load Terminals (2): .110 [2.79]

Filtered Models



Typical Dimensions:
Line Inlet (1): IEC 60320-1 C14
Load Terminals (2): .110 [2.79]

Recommended Panel Cutouts



Standard units mount in panel thickness of .060 - .090 [1.52 - 2.29]
JA403 Mounting clips for .105 - .125" panels available separately
Fuse cover door shown in open position

Case Dimensions

Part No.	A (max.)	B (max.)	C (max.)	D (max.)
6VJ1, 6VJ1-2	2.68 68.1	1.52 38.6	1.17 29.7	1.23 31.2
6J4, 6J4-2, 6HJ4-4, 6HJ4-2	2.75 69.9	1.87 47.5	1.17 29.7	1.58 40.1

Performance Data

Typical Insertion Loss

Measured in closed 50 Ohm system

6J4



6HJ4



— Common Mode / Asymmetrical (L-G)
- - - Differential Mode / Symmetrical (L-L)

Minimum Insertion Loss

Measured in closed 50 Ohm system

Common Mode / Asymmetrical (Line to Ground)

Model No.	Frequency – MHz						
	.15	.5	1	5	10	20	30
6J4	9	20	25	41	45	45	48
6HJ4	9	11	15	19	13	12	10

Dual Configuration Power Entry Module

L Series



UL Recognized
CSA Certified
VDE Approved



L Series

- Power entry module with switch or fuse
- For 10A capability and high performance filtering see the P Series on page 192
- Two element circuit provides extended EMI attenuation similar to EAB inlet filter
- North American or metric fuse holders
- Available with minimal leakage current for medical applications (HL models)

Ordering Information



Specifications

Maximum leakage current each Line to Ground:

	<u>DL Models</u>	<u>HL Models</u>
@ 120 VAC 60 Hz:	.25 mA	2 µA
@ 250 VAC 50 Hz:	.50 mA	5 µA

Hipot rating (one minute):

Line to Ground:	2250 VDC
Line to Line:	1450 VDC

Operating Voltage:

1S & 1SC models (fixed):	250 VAC max.
4 & 4C Suffix:	100, 120, 220 or 240 VAC.

Operating Frequency:

50/60 Hz

Rated Current:

2 to 6A

Required Fuse(s):

North American:	one .25 x 1.25" (<i>not included</i>)
Metric:	two 5 x 20mm (<i>not included</i>)

Switch:

DPST
10,000 operations at 51A max. inrush



Dual Configuration Power Entry Module *(continued)*

L Series

Available Part Numbers		North American Fusing		Metric Fusing	
		Flange Mount	Snap-In	Flange Mount	Snap-In
Non-Filtered	Single Voltage, Switched	6EL1S	6EL1SC	6EL1SM	6EL1SCM
	4 Voltage Select, No Switch	6EL4	6EL4C	6EL4M	6EL4CM
General Purpose Filter	Single Voltage, Switched	2EDL1S	2EDL1SC	2EDL1SM	2EDL1SCM
		4EDL1S	4EDL1SC	4EDL1SM	4EDL1SCM
		6EDL1S	6EDL1SC	6EDL1SM	6EDL1SCM
	4 Voltage Select, No Switch	2EDL4	2EDL4C	2EDL4M	2EDL4CM
		4EDL4	4EDL4C	4EDL4M	4EDL4CM
		6EDL4	6EDL4C	6EDL4M	6EDL4CM
Medical Filter	Single Voltage, Switched	6EHL1S	6EHL1SC	6EHL1SM	6EHL1SCM
	4 Voltage Select, No Switch	6EHL4	6EHL4C	6EHL4M	6EHL4CM

Voltage Selection

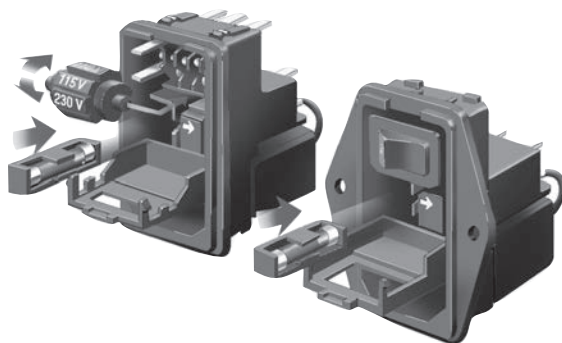

To change selected voltage: disconnect the power cord; open cover using a small blade screwdriver or similar tool; insert the tool into the voltage selection slot and remove wheel from unit; select desired voltage; replace wheel into unit and close cover, making sure the selected voltage appears in connector window.

Recommended Panel Cutouts



- Notes:
- (1) For panel thickness of .031 – .079 [0.8 – 2.0]
 - (2) For panel thickness of .083 – .126 [2.1 – 3.2]
 - (3) Mounting Holes .126 [3.20] Dia. for flange mounted versions only
 - (4) For Snap-In applications, the 1.12 [28.5] sides of the cutout must have a .02 [.508] radius on the installation side. Not required for flange mount versions.

Dual Configuration Power Entry Module *(continued)*

L Series

Electrical Schematics

DL Models

Single Voltage, Switched (DL1S)



4 Voltage Select, No-Switch (DL4)



HL Models

Single Voltage, Switched (HL1S)



4 Voltage Select, No-Switch (HL4)



Note 1: Provision for dual Metric style fusing
Note 2: On/Off switch present only with "S" suffix models

Accessories

GA400: NEMA 5-15P to IEC 60320-1 C-13 line cord

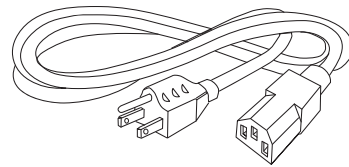

LA303: Voltage Select Wheel, 3 position
Selection drum for use with L4 models.
Marked with 110V, 220V and 240V

LA304: Voltage Select Wheel, 4 position
Selection drum for use with L4 models.
Marked with 100V, 110V, 220V and 240V.
One LA304 comes standard with each L4 model.



LA400: Blank insert
Blank to replace switch in single voltage models

LA601: Insulating Boot
Plastic shroud to cover back of module to prevent inadvertent access

Replacement Fuse Holders

LA200: North American Fuseholder
Accommodates one .25 x 1.25" fuse

LA201: Metric Fuseholder
Accommodates one 5 x 20mm metric fuse



Dual Configuration Power Entry Module *(continued)*

L Series

Case Styles

Flange Models, Non-filtered



Switched model shown, for non-switched detail refer to snap-in models

Typical Dimensions:
Line Inlet (1): IEC 60320-1 C14
Backplate Terminals: .110 [2.79]
Switch Terminals: .187 [4.765] with .07 x .16 [1.8 x 3.8] slot

Snap-in Models, Non-filtered



Non-switched model shown, for switched detail refer to flange models

Typical Dimensions:
Line Inlet (1): IEC 60320-1 C14
Backplate Terminals: .110 [2.79]
Switch Terminals: .187 [4.765] with .07 x .16 [1.8 x 3.8] slot

Flange Models, Filtered



Switched model shown, for non-switched detail refer to snap-in models
Metric fuse models have an additional jumper from filter to module

Typical Dimensions:
Line Inlet (1): IEC 60320-1 C14
Backplate Terminals: .110 [2.79]
Switch Terminals: .187 [4.765] with .07 x .16 [1.8 x 3.8] slot

Snap-in Models, Filtered



Non-switched model shown, for switched detail refer to flange models
Metric fuse models have an additional jumper from filter to module

Typical Dimensions:
Line Inlet (1): IEC 60320-1 C14
Backplate Terminals: .110 [2.79]
Switch Terminals: .187 [4.765] with .07 x .16 [1.8 x 3.8] slot

Case Dimensions

	A	B	C	D	E	F
Model No.	(max.)	$\pm .015$ $\pm .38$	(max.)	(max.)	(max.)	(ref.)
Flange Unfiltered	1.98 50.29	1.575 40.0	2.3 58.42	2.14 54.36	1.66 42.16	1.11 28.19
Snap-in Unfiltered	1.28 32.51	-	2.3 58.42	2.14 54.36	1.66 42.16	1.11 28.19
Flange Filtered	1.98 50.29	1.575 40.0	2.3 58.42	2.14 54.36	2.01 51.05	1.11 28.19
Snap-in Filtered	1.28 32.51	-	2.3 58.42	2.14 54.36	2.01 51.05	1.11 28.19

Dual Configuration Power Entry Module *(continued)*

L Series

Performance Data

Typical Insertion Loss

Measured in closed 50 Ohm system

2EDL



4EDL



6EDL



6EHL



— Common Mode / Asymmetrical (L-G)
— Differential Mode / Symmetrical (L-L)

Minimum Insertion Loss

Measured in closed 50 Ohm system

Common Mode / Asymmetrical (Line to Ground)

Current Rating	Frequency – MHz					
	.05	.15	1	5	10	30
EDL Models						
1A	6	14	24	40	45	50
3A	2	8	18	32	38	45
6A	1	6	17	31	37	45
EHL Models						
6A	3	8	15	18	18	18

Differential Mode / Symmetrical (Line to Line)

Current Rating	Frequency – MHz						
	.05	.15.5	1	3	5	10	30
EDL Models							
1A	7	16	21	23	37	47	50
3A	6	14	18	23	26	45	47
6A	6	15	20	25	24	45	50
EHL Models							
6A	4	14	20	28	32		

Power Entry Module with Enhanced EMI Filtering

LA Series



UL Recognized
CSA Certified



LA Series

- Power entry module with extended and enhanced low frequency filters
- North American or dual metric fuse holder options
- DPST on/off switch
- 120/240V voltage selection
- The F version provides basic performance two element circuit filter
- The X version provides a three element differential mode circuit with extended EMI attenuation, suitable for meeting FCC Part 15J, Class B conducted emissions limits
- The Z version provides a three element differential mode circuit with enhanced EMI low frequency attenuation, suitable for meeting EN55022 Level B as well as FCC Part 15J limits

Ordering Information



*IEC 60320-1 C14 inlet mates with C13 connector

Specifications

Maximum leakage current each Line to Ground:

	FLA Model	XLA or ZLA Model
@120 VAC 60 Hz:	.25 mA	.30 mA
@250 VAC 50 Hz:	.50 mA	.50 mA

Hipot rating (one minute):

Line to Ground:	2250 VDC
Line to Line:	1450 VDC

Rated Voltage (max.):

250 VAC

Operating Frequency:

50/60 Hz

Rated Current:

3 to 5A

Required Fuse(s):

one .25 x 1.25" (not included)
or two 5 x 20mm (not included)

Switch:

DPST
10,000 operations at 51A max. inrush

Available Part Numbers

5EFLA2S
3EXLA2S
3EZLA2S

Power Entry Module with Enhanced EMI Filtering *(continued)*

LA Series

Voltage Selection

To change selected voltage: remove the fuse cartridge using a small blade screwdriver or similar tool; select the desired voltage by matching the arrow on the fuse cartridge to the arrow located on the front of the unit (lower right corner); replace the fuse cartridge making sure the voltage selection arrow aligns with the arrow located on the front of the unit.

Changing Fuses

Remove the fuse cartridge using a small blade screwdriver or similar tool; for Metric fusing pull out the sliding fuse covers located at the top of each fuse compartment; insert desired fuses; push the sliding fuse covers back in place and insert the fuse cartridge back into the unit making sure the voltage selection arrow aligns with the arrow located on the front of the unit. (Note: Single North American or Metric fuse placement is always on the side of the desired voltage selection arrow behind the fuse symbol; the other compartment may be used as a spare or be left blank. Dual Metric fusing capability is available for 220/240 volts only.)

Electrical Schematics

FLA Model



XLA & ZLA Model



Case Styles

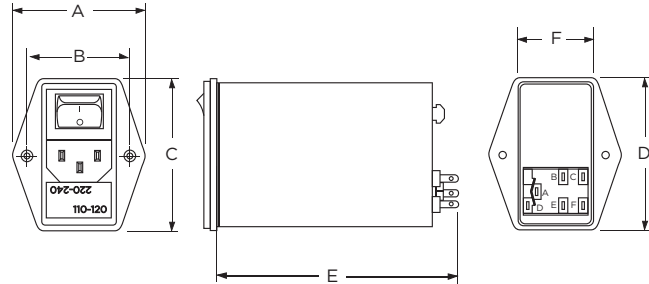

Typical Dimensions:

- Line Inlet (1): IEC 60320-1 C14
- Mounting Holes (2): .142 [3.6] Dia.
- Backplate Terminals(5): .110 [2.79] with .059 [1.5] holes
- Ground: solder lug tab with wire wrap

Case Dimensions

Part No.	A (max.)	B $\pm .015$ $\pm .38$	C (max.)	D (max.)	E (max.)	F (ref.)
5EFLA2S	1.99 50.5	1.57 39.9	2.59 65.79	2.41 61.21	3.16 68.07	1.18 29.97
3EXLA2S	1.99 50.5	1.57 39.9	2.59 65.79	2.41 61.21	4.16 105.7	1.18 29.97
3EZLA2S	1.99 50.5	1.57 39.9	2.59 65.79	2.41 61.21	4.16 105.7	1.18 29.97

Recommended Panel Cutout



Power Entry Module with Enhanced EMI Filtering *(continued)*

LA Series

Performance Data

Typical Insertion Loss

Measured in closed 50 Ohm system

5EFLA2S



3EXLA2S



3EZLA2S



— Common Mode / Asymmetrical (L-G)
— Differential Mode / Symmetrical (L-L)

Minimum Insertion Loss

Measured in closed 50 Ohm system

Common Mode / Asymmetrical (Line to Ground)

Part No.	Frequency – MHz							
	.01	.05	.15	.5	1	5	10	30
5EFLA2S	-	-	14	21	26	40	46	50
3EXLA2S	2	12	21	35	46	44	44	40
3EZLA2S	14	28	38	42	40	40	40	40

Differential Mode / Symmetrical (Line to Line)

Part No.	Frequency – MHz									
	.02	.03	.05	.07	.15	.5	1	5	10	30
5EFLA2S	-	-	-	-	-	-	-	-	-	-
3EXLA2S	-	-	-	5	33	60	65	60	50	50
3EZLA2S	3	14	29	38	57	72	72	65	55	50

Slim Power Entry Module Family with Multiple Options

M Series



UL Recognized
CSA Certified
VDE Approved



Ordering Information



M Series

- Family of slim power entry modules that consume minimal depth behind panel
- Four compact modules each provide a different option combination
- Available non-filtered or with one of four filter circuits designed to meet a wide variety of applications
- Optional voltage selector configured for either 2 or 4 voltage selection
- Optional DPST on/off switch
- Included fuseholder accepts either single 3AG fuse or dual metric fuses
- Snap-in or flange mounting styles

Filter Types

H Models provide a basic performance dual element circuit EMI filter with minimal leakage current, suitable for medical applications, with attenuation similar to the EAH Series power inlet filter.

F Models provide a basic performance dual element circuit EMI filter, with attenuation similar to the EEA Series Power Inlet Filter.

X Models provide a high performance three element differential circuit filter, with extended EMI attenuation similar to the X Series chassis filter, suitable for bringing most digital equipment (including switching power supplies) into compliance with FCC Part 15J, Class B conducted emissions limits.

Z Models provide a premium performance three element differential circuit filter, with enhanced EMI low frequency attenuation similar to the P Series Z models, suitable for bringing most digital equipment (including switching power supplies) into compliance with EN55022 Level B as well as FCC Part 15J. For minimum panel footprint, see the P series on page 192.

Slim Power Entry Module Family with Multiple Options *(continued)*

M Series

Specifications

Maximum leakage current each Line to Ground:

	HM	FM	XM/ZM
@ 120 VAC 60 Hz:	2 μ A	.25 mA	.30 mA
@250 VAC 50 Hz:	5 μ A	.50 mA	.50 mA

Hipot rating (one minute):

Line to Ground:	2250 VDC
Line to Line:	1450 VDC
Line to Load (switch off) non-filtered:	2500 VAC

Rated Voltage (max.): 250VAC

Operating Frequency: 50/60 Hz

Rated Current @ 120 VAC: 3 to 6A

Rated Current @ 250 VAC:	
3A models:	2A
5A models:	4A
6A Switched models:	5A
6A non-switched models:	6A

Required Fuse(s): Reversible fuseholder accepts one .25 x 1.25" (not included) or two 5 x 20mm (not included)

Switch: DPST
100,000 operations at 70A max. inrush

Available Part Numbers

Non-Filtered Models				
Voltage Selections	Flange Mount		Snap-In	
1	6VM1	6VM1S	6VM1C	6VM1SC
2	6VM2	6VM2S		
4	6VM4	6VM4S	6VM4C	6VM4SC
General Purpose Filters				
1	5EFM1	5EFM1S	5EFM1C	5EFM1SC
4	5EFM4	5EFM4S	5EFM4C	5EFM4SC
Medical Filters				
1	5EHM1	5EHM1S		
4	5EHM4	5EHM4S		
High Performance - FCC-B				
1		3EXM1S		
4	3EXM4	3EXM4S		
Premium Performance - EN55022-B				
1		3EZM1S		
4	3EZM4	3EZM4S		

Accessories

GA400: NEMA 5-15P to IEC 60320-1 C-13 line cord

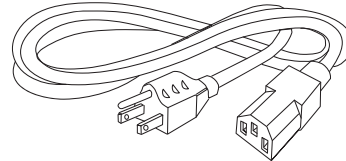

MA100: Power interconnect assembly
For voltage select models. 8.5" wire leads

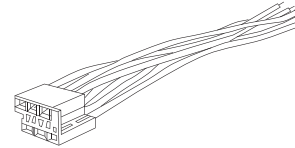

MA101: Plug only

MA102: Strip of 100 pins for use with MA101

MA104: Individual pins for use with MA101

MA302: Two Voltage Selection Card

Marked 120V/240V. One card comes standard with every 2 voltage M series module

MA304: Four Voltage Selection Card

Marked 100V/120V/230V/240V. One card comes standard with every 4 voltage M series module

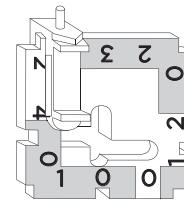

MA400: Medical safety bracket assembly

Prevents inadvertent removal of fuse(s)

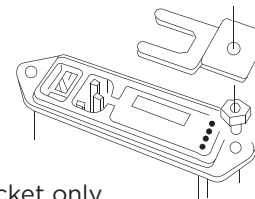

MA401: Bracket only

MA402: Standoff only

Slim Power Entry Module Family with Multiple Options *(continued)*

M Series

Accessories *(continued)*

MA601 - 604: Insulating Boot

Plastic shroud for back of M series to prevent inadvertent access to connections



- MA601: Fits M4S versions
- MA602: Fits M1S versions
- MA603: Fits M4 versions
- MA604: First M1 versions

Voltage Selection

1. Open cover, using small blade screwdriver or similar tool *(see illustration on right)*
2. Set aside cover/fuse block assembly
3. Pull voltage selector card straight out of housing, using indicator pin
4. Orient selector card so that desired voltage is readable at the bottom
5. Orient indicator pin to point up when desired voltage is readable at bottom *(note that when indicator pin is fixed, successive voltages are selected by rotating the card 90° clockwise)*
6. Insert voltage selector card into housing, printed side of card facing forward toward IEC connector and edge containing the desired voltage first
7. Replace cover, and verify that indicator pin shows the desired voltage



Fuse Installation Instructions

1. Remove power cord



2. Insert a pocket screwdriver at point "X" as shown



3. Gently lift the entire door UP approximately 1/4" *(minimum)*. Once lifted, the door will pivot on it's hinges to expose the fuse holder

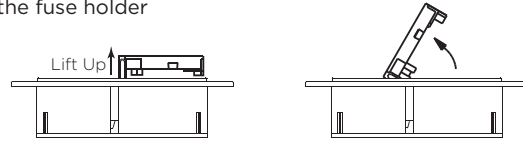

4. When the fuse holder is installed in the single fuse position, apply the screwdriver as shown and gently lift up. Use screwdriver as shown, do not use fingers



When the fuse holder is installed in the dual fuse position, it will normally release as soon as the door is opened

5. Install one (1) AG fuse or two (2) metric fuses (see below)
6. Replace fuse holder into housing
7. Swing and push to snap door back in place

Fuse Options



North American single fuse installation

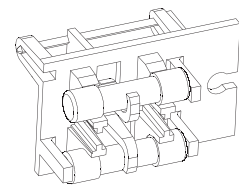

Metric dual fuse installation

Install fuses on one side only, do not install both AG and metric fuses at the same time

Slim Power Entry Module Family with Multiple Options *(continued)*

M Series

Electrical Schematics

Non-Filtered Models

VM1



VM2

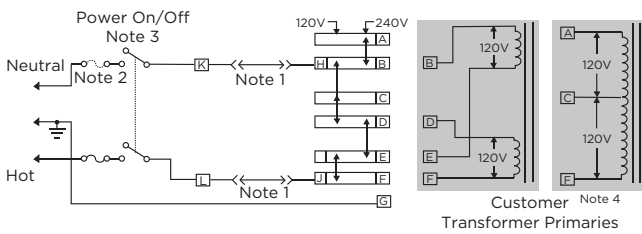

VM4



- Note 1: Jumper required if no input filter is used
- Note 2: Provision for dual Metric style fusing
- Note 3: On/off switch present only in "S" suffix models
- Note 4: When using a center-tapped transformer, the C-F winding should be the low voltage (high current) winding and must be capable of handling the full primary current in the 120V position

Filtered Models

FM1 & HM1



FM4 & HM4



XM1 & ZM1



XM4 & ZM4



- Note 1: Provision for dual Metric style fusing
- Note 2: On/off switch present only in "S" suffix models
- Note 3: Line to ground capacitor not present on HM models
- Note 4: Models HM4, FM4, XM4 and ZM4 have added terminals K and L. External switch or jumper must be placed from K to H and L to J

Slim Power Entry Module Family with Multiple Options *(continued)*

M Series

Case Styles - Non-filtered Models

6VM1



Typical Dimensions:
 Line Inlet (1): IEC 60320-1 C14
 Backplate Terminals: .110 [2.79]
 Mounting holes (2): .155 [3.94] Dia. with .279 [7.08] Dia. x 82°
 countersink for #6 flathead screw

6VM1C



Typical Dimensions:
 Line Inlet (1): IEC 60320-1 C14
 Backplate Terminals: .110 [2.79]

6VM1S



Typical Dimensions:
 Line Inlet (1): IEC 60320-1 C14
 Backplate Terminals: .110 [2.79]
 Mounting holes (2): .155 [3.94] Dia. with .279 [7.08] Dia. x 82°
 countersink for #6 flathead screw

6VM1SC



Typical Dimensions:
 Line Inlet (1): IEC 60320-1 C14
 Backplate Terminals: .110 [2.79]

6VM2 & 6VM4



Typical Dimensions:
 Line Inlet (1): IEC 60320-1 C14
 Backplate Terminals: .110 [2.79]
 Mounting holes (2): .155 [3.94] Dia. with .279 [7.08] Dia. x 82°
 countersink for #6 flathead screw

6VM4C



Typical Dimensions:
 Line Inlet (1): IEC 60320-1 C14
 Backplate Terminals: .110 [2.79]

6VM2S & 6VM4S



Typical Dimensions:
 Line Inlet (1): IEC 60320-1 C14
 Backplate Terminals: .110 [2.79]
 Mounting holes (2): .155 [3.94] Dia. with .279 [7.08] Dia. x 82°
 countersink for #6 flathead screw

6VM4SC



Typical Dimensions:
 Line Inlet (1): IEC 60320-1 C14
 Backplate Terminals: .110 [2.79]

Slim Power Entry Module Family with Multiple Options *(continued)*

M Series

Case Styles - Filtered Models

3EXM1S & 3EZM1S



Typical Dimensions:
 Line Inlet (1): IEC 60320-1 C14
 Backplate Terminals: .110 [2.79]
 Threaded insert: 6-32 x .25
 Mounting holes (2): .155 [3.94] Dia. with .279 [7.08] Dia. x 82° countersink for #6 flathead screw

3EXM4S & 3EZM4S



Typical Dimensions:
 Line Inlet (1): IEC 60320-1 C14
 Backplate Terminals: .110 [2.79]
 Threaded insert: 6-32 x .25
 Mounting holes (2): .155 [3.94] Dia. with .279 [7.08] Dia. x 82° countersink for #6 flathead screw

3EXM4 & 3EZM4



Typical Dimensions:
 Line Inlet (1): IEC 60320-1 C14
 Backplate Terminals: .110 [2.79]
 Threaded insert: 6-32 x .25
 Mounting holes (2): .155 [3.94] Dia. with .279 [7.08] Dia. x 82° countersink for #6 flathead screw

5EHM1 & 5EFM1



Typical Dimensions:
 Line Inlet (1): IEC 60320-1 C14
 Backplate Terminals: .110 [2.79]
 Mounting holes (2): .155 [3.94] Dia. with .279 [7.08] Dia. x 82° countersink for #6 flathead screw

Slim Power Entry Module Family with Multiple Options *(continued)*

M Series

Case Styles - Filtered Models *(continued)*

5EFM1C



Typical Dimensions:
Line Inlet (1): IEC 60320-1 C14
Backplate Terminals: .110 [2.79]

5EHM1S & 5EFM1S



Typical Dimensions:
Line Inlet (1): IEC 60320-1 C14
Backplate Terminals: .110 [2.79]
Mounting holes (2): .155 [3.94] Dia. with .279 [7.08] Dia. x 82° countersink for #6 flathead screw

5EFM1SC



Typical Dimensions:
Line Inlet (1): IEC 60320-1 C14
Backplate Terminals: .110 [2.79]

5EHM4 & 5EFM4



Typical Dimensions:
Line Inlet (1): IEC 60320-1 C14
Backplate Terminals: .110 [2.79]
Mounting holes (2): .155 [3.94] Dia. with .279 [7.08] Dia. x 82° countersink for #6 flathead screw

5EFM4C



Typical Dimensions:
Line Inlet (1): IEC 60320-1 C14
Backplate Terminals: .110 [2.79]

5EHM4S & 5EFM4S



Typical Dimensions:
Line Inlet (1): IEC 60320-1 C14
Backplate Terminals: .110 [2.79]
Mounting holes (2): .155 [3.94] Dia. with .279 [7.08] Dia. x 82° countersink for #6 flathead screw



Power Inlet Filters & Power Entry Modules

Slim Power Entry Module Family with Multiple Options *(continued)*

M Series

Case Styles - Filtered Models *(continued)*

5EFM4SC

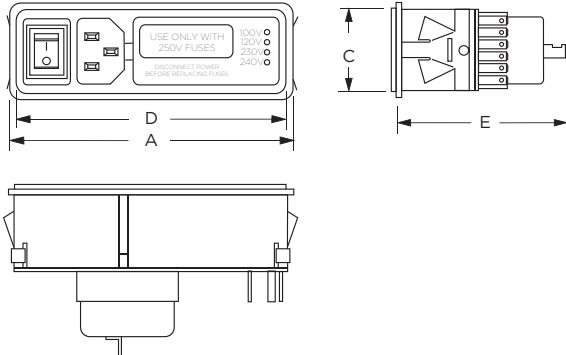

Typical Dimensions:
Line Inlet (1): IEC 60320-1 C14
Backplate Terminals: .110 [2.79]

Recommended Panel Cutouts



Note:
XM and ZM models allow back mount only
FM and HM models allow front or back mounting
Mounting holes on flange mount models only
Snap-In models allow front mounting only
Snap-In models panel thickness: .06 - .09 [1.53 - 2.29]

Case Dimensions

Part No.	A (max.)	B (max.)	C (max.)	D $\pm .015$ $\pm .38$	E (max.)	F (ref.)	G (ref.)
6VM1	3.39 86.1	2.84 72.1	1.14 29.0	2.44 62.0	1.45 36.8	2.5 63.5	-
6VM1C	2.56 86.1	-	1.14 29.0	2.44 62.0	1.45 36.8	2.5 63.2	-
6VM1S	4.17 105.9	3.62 91.9	1.14 29.0	3.22 81.8	1.45 36.8	3.28 83.3	-
6VM1SC	3.34 84.8	-	1.14 29.0	3.27 83.1	1.45 36.8	3.27 83.1	-
6VM2	3.88	3.32	1.14	2.92	1.45	2.98	-
6VM4	98.6	84.3	29.0	74.2	36.8	75.7	-
6VM4C	3.04 98.6	-	1.14 29.0	2.92 74.2	1.45 36.8	2.97 75.4	-
6VM2S	4.65	4.1	1.14	3.72	1.45	3.76	-
6VM4S	118.1	104.1	29.0	94.5	36.8	95.5	-
6VM4SC	3.82 97.0	-	1.14 29.0	3.7 94.0	1.45 36.8	3.75 95.3	-
3EXM1S	4.17	3.62	1.14	3.22	1.72	3.28	3.3
3EZM1S	105.9	91.9	29.0	81.8	43.7	83.8	83.8
3EXM4	3.88	3.32	1.14	2.92	1.72	2.98	2.99
3EZM4	98.6	84.3	29.0	74.2	43.7	75.7	75.9
3EXM4S	4.65	4.1	1.14	3.72	1.72	3.76	3.8
3EZM4S	118.1	104.1	29.0	94.5	43.7	95.5	96.5
5EHM1	3.39	2.84	1.14	2.44	2.19	2.5	-
5EFM1	86.1	72.1	29.0	62.0	55.6	63.5	-
5EFM1C	2.56 65.0	-	1.14 29.0	2.44 62.0	2.19 55.6	2.49 63.2	-
5EHM1S	4.17	3.62	1.14	3.22	2.19	3.28	-
5EFM1S	105.9	91.9	29.0	81.8	55.6	83.3	-
5EFM1SC	3.34 84.8	-	1.14 29.0	3.27 83.1	2.19 55.6	3.27 83.1	-
5EHM4	3.88	3.32	1.14	2.92	2.19	2.98	-
5EFM4	98.6	84.3	29.0	74.2	55.6	75.7	-
5EFM4C	3.04 77.2	-	1.14 29.0	2.92 74.2	2.19 55.6	2.97 74.4	-
5EHM4S	4.65	4.1	1.14	3.7	2.19	3.76	-
5EFM4S	118.1	104.1	29.0	94.0	55.6	95.5	-
5EFM4SC	3.82 97.0	-	1.14 29.0	3.7 94.0	2.19 55.6	3.75 95.3	-

Slim Power Entry Module Family with Multiple Options *(continued)*

M Series

Performance Data

Typical Insertion Loss

Measured in closed 50 Ohm system

5EHM



5EFM



3EXM



3EZM



— Common Mode / Asymmetrical (L-G)
— Differential Mode / Symmetrical (L-L)

Minimum Insertion Loss

Measured in closed 50 Ohm system

Common Mode / Asymmetrical (Line to Ground)

Part No.	Frequency – MHz							
	.01	.05	.15	.5	1	5	10	30
5EHM Models	-	-	14	18	19	22	22	17
5EFM Models	-	-	14	21	26	40	45	40
3EXM Models	2	13	23	40	46	44	44	44
3EZM Models	15	29	39	46	43	40	40	40

Differential Mode / Symmetrical (Line to Line)

Part No.	Frequency – MHz									
	.02	.03	.05	.07	.15	.5	1	5	10	30
3EXM Models	-	-	-	5	34	62	68	60	50	40
3EZM Models	5	13	28	37	55	75	75	62	54	44

Versatile Power Entry Module with Small Footprint

P Series



UL Recognized
CSA Certified
VDE Approved



P Series

The P series CHAMELEON power entry module offers the most popular features in a small footprint design. As the first 10A module to provide all five power entry functions in one compact design, the chameleon module readily adapts to its environment and the needs of international markets.

- Snap-in or flange mounting
- Standard IEC 60321-1 C14 power inlet
- Both North American and metric fusing capabilities
- Two voltage selection options (for 4-voltage selection, see the M, L or LA Series)
- Optional DPST on/off switch
- Filter options for general purpose, medical and high-performance EMI filtering

The CHAMELEON module's compact design and modular construction allows selection of the required power entry feature — without altering the panel cutout. And the CHAMELEON module, with its optional adapters, will fit several common panel cutouts.

Filter Types

The CHAMELEON module has four filter and one non-filtered option:

S models provide an extended performance two element circuit EMI filter, with attenuation similar to the EEB Series power inlet filter. It offers protection for general purpose applications with stray Line to Ground and Line to Line noise that must be attenuated at the power inlet. These filters have limited leakage current and are available in current ratings of 3, 6 and 10A.

H models provide susceptibility protection with minimal leakage current, and are suitable for patient care and non-patient care medical equipment.

L models feature a high performance medical filter designed to help bring most digital equipment (including switching power supplies) into compliance with EN55022, Level B (as well as FCC part 15J, Class B) conducted emissions limits. They are available with current ratings of 6 and 10A. These high performance versions are only available with mounting ears, single voltage selection, in a complete RFI shield with options for switch, fuses and current ratings. Mounting extenders are not compatible with the L or Z models.

Z models provide a high performance three element differential mode circuit filter, with extended EMI attenuation similar to the M Series Z models, to help bring most digital equipment (including switching power supplies) into compliance with EN55022, Level B (as well as FCC Part 15J, Class B) conducted emissions limits. They are available with current ratings of 6 and 10A. These high performance versions are only available with mounting ears, single voltage selection, in a complete RFI shield with options for switch, fuses and current ratings. Mounting extenders are not compatible with the L or Z models. For minimum depth behind the panel, see the M Series

B models are non-filtered and incorporate an inter-connection block. The block connects the voltage selection terminals of an unfiltered CHAMELEON module with an IEC connector and an optional switch to reduce external wiring. Compatible with the A or B RFI shield options.

Versatile Power Entry Module with Small Footprint *(continued)*

P Series

Ordering Information

Part numbers are constructed by selecting the alphanumeric character which represents the desired feature.
Note: For any option where shown as "0" use the digit ZERO (0) not the letter (O).

Mounting Style	Extender Options ¹	Switch Options*	Voltage Select ²	Fuse Options	Filter Type	Filter Current	Shield Options ¹	
P	S	J	O	X	S	S	6	O
Mounting Style E = Mounting ears (Horizontal axis) S = Snap-in M = Mounting ears (Vertical axis)	Extender Option O = None C = FN260 J = J Series L = L Series ¹	Switch Option O = Blank S = Double pole single throw (DPST)	Input Voltage Select O = Single voltage S = Dual voltage ² select (SMPS) X = Dual voltage ² select (series/parallel)	Fuse Options D = Dual fuse S = Single fuse	Filter Type O = No filter B = Interconnection block ³ H = Medical Filter L = High Performance Medical ⁴ S = General purpose Z = High Performance ⁴	Filter Current O = No filter 3 = 3A 6 = 6A X = 10A	Shield Options O = No shield A = Filter shield B = Complete Shield C = Complete can (for L & Z models)	



Notes:

- 1 L Series extender cannot be added to units with a shield. No style of extender can be added to units with B or C shields.
 - 2 Dual voltage options are not available with L or Z Filter Types
 - 3 When using the interconnection block, the last 3 digits of the part number are BX (O, A, or B)
 - 4 High performance versions (L or Z filter types) are available with any switch or fuse option but only in 6 or 10A with horizontal (PE) or vertical (PM) mounting ears, single voltage (O), complete shield (C) and no extenders
- * For alternative switch orientation options, please contact technical support or your Corcom product sales representative

The part number **PS0SXSS6B** would represent:
 P Series (P) with a snap-in mount (S) with no extender (O) a switch (S) dual voltage select (X) single fusing (S) general purpose filter (S) for 6A (6) with a B shield (B)

Versatile Power Entry Module with Small Footprint *(continued)*

P Series

Voltage Selection

P series power entry modules include the voltage selector integral with the fuse holder. Three voltage selection options are each supported by one of three different fuse holders. The fifth digit of the part number specifies which of the three fuse holders is included to provide the desired voltage selection. The single voltage fuse holder (option "O") has no voltage indication markings. The dual voltage options select 115V or 230V by removing the fuse holder, flipping it over, and reinstalling it. Voltage selection is indicated through a window in the P Series door. The "SMPS" fuse holder (option "S") jumpers two independent P Series terminals to indicate 230V operation to a switching mode power supply. The "PRSR" parallel/serial fuse holder (option "X") connects the windings of the equipment's dual primary transformer (not included) to step down the voltage or double up the current. The markings on the voltage selection fuse holders also remind the user to install the appropriate fuse for the current at the selected voltage.

Input Voltage Selection Schemes

S - "SPMS" Jumper Type



X - "PRSR" Parallel / Serial Type for Dual Primary Transformer



Note 1: Additional jumper wiring is required if a filter or interconnection module is not used.
Note 2: Location of optional filter. Additional jumper wiring is required if a filter or interconnection block is not used.

Shield Options

The P series offers several RF shield options. The metal shield, optional on S, H and B filtered models, provides shielding from radiated emissions and provides an RF ground for the filter to the panel. This shield is available in two versions; a shield of the filter components (designated by an A as the final digit) and a complete shield (designated by B as the final digit).

The A shield covers the filter portion of the module and increases performance of the filter by protecting the components from RFI coupling. This shield allows the use of the C or J extender.

The B shield covers the entire power entry module with metal, protecting the filter from RFI coupling, and covering the mounting cut-out to block RFI entering or leaving the equipment. The B shield cannot be used with any extender.

A complete metal enclosure is integral to both the high performance L and Z models, and must be specified by a C in the part number's final digit. This option is only available with the L or Z models.



"A" Shield



"B" Shield

Versatile Power Entry Module with Small Footprint *(continued)*

P Series

Fuseholder

Another feature of the P series power entry module is the versatile fusing arrangement. The fuse holder can hold two 1/4" x 1-1/4" (3AG) or 5 x 20mm (metric) fuses. Single fusing is supported with a conversion clip that shorts one of the two fuse positions, and is designated by an S in the sixth part number digit. A module designated for a single fuse may be reconfigured by the manufacturer or the user to accept two fuses by simply removing the shorting clip. For applications intended for dual fusing, specify a D in the sixth part number digit.



Interconnection Block

Installation of the unfiltered versions of the P series requires wiring of the IEC socket terminals to the optional switch and the switch to the fuse holder. Labor can be eliminated by ordering the module with an interconnection block. This feature, designated by "BX" in the seventh and eighth digits, prewires the module so that only connection to the equipment must be done during installation. The interconnection block includes a plastic case to prevent access to the internal connections.

The dimensions of this alternative are the same as the filtered versions.



Accessories

GA400: NEMA 5-15P to IEC 60320-1 C-13 line cord

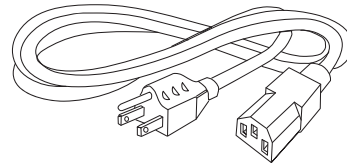

PA100: Power interconnect assembly
For voltage select models. Designed for use with either filtered or non-filtered units, 6" wire leads



PA101: Plug only

PA102: Pins only for use with PA101

PA105: Same as PA100 but with two wires for units with no voltage selection

PA400: J Extender

Extends P Series height to fit J panel cutout

PA410: L Extender

Extends P Series width to fit L panel cutout

PA420: C Extender

Extends P Series height to fit C panel cutout

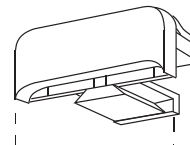

PA400
J Series Extender

*C & L Extenders can not be used with B Shields.
L Extender can not be used with shields*

Versatile Power Entry Module with Small Footprint *(continued)*

P Series

Specifications

Maximum leakage current each Line to Ground:

	H & L Models	S & Z Models
@ 120 VAC 60 Hz:	2 μ A	.25 mA
@ 250 VAC 50 Hz:	5 μ A	.50 mA

Hipot rating (one minute):

Line to Ground:	2250 VDC
Line to Line:	1450 VDC

Rated Voltage(max.): 250VAC

Operating Voltages:
Selectable or Fixed 115/230 VAC

Operating Frequency: 50/60 Hz

Rated Current:
Non-Filtered - 10A
Filtered - 3, 6 or 10A

Fuseholder: Accepts one or two fuses
.25 x 1.25" (not included)
or 5 x 20mm (not included)

Switch: DPST
10,000 operations at 51A max. inrush

Electrical Schematics

H Model



S Model



L Model



Z Model



Case Styles

Front View



Typical Dimensions:
Line Inlet (1): IEC 60320-1 C14
Mounting holes (2): .135 [3.43] Dia. with .23 [5.9] Dia. x 82° countersink for #4 flathead screw (PM, PE only)

Versatile Power Entry Module with Small Footprint *(continued)*

P Series

Case Styles *(continued)*

Extender Options

C Extender - FN260



J Extender - J Series



Standard Models - Side and Rear View

Non-Filtered



Filtered



Typical Dimensions:

- Terminals: .187 [4.8] with .055 [1.4] Dia. hole. Recommended for use with mating connectors - no solder
- Ground Terminal (1): .187 [4.8] with .112 x .06 [2.8 x 1.5] slot. Recommended for use with mating connectors - no solder

High Performance Models - Side and Rear View

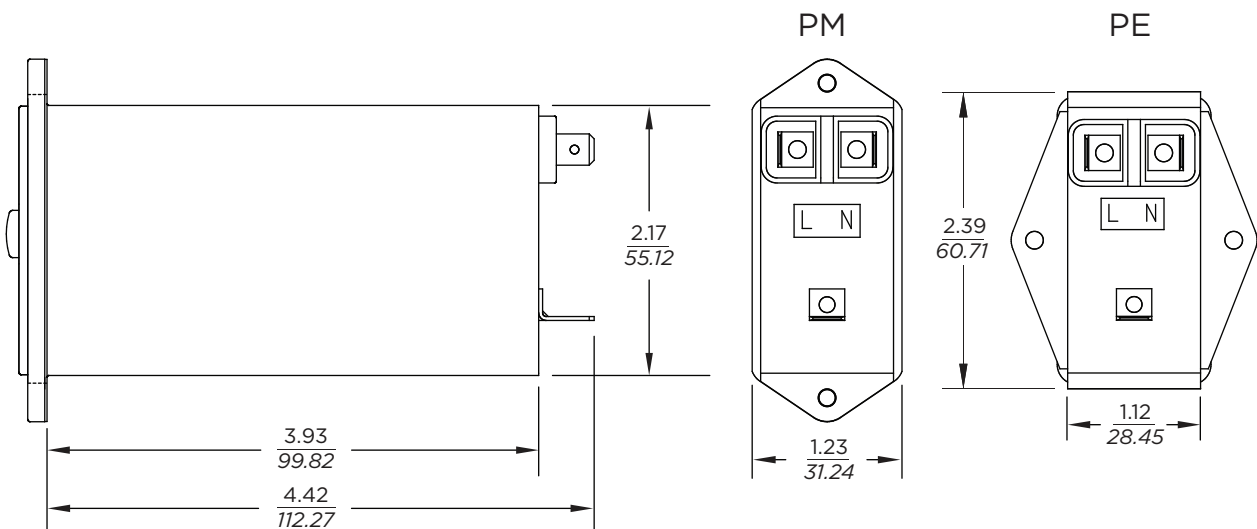

Typical Dimensions:

- Terminals: .250 [6.4] with .07 [1.8] Dia. hole. Recommended for use with mating connectors - no solder
- Ground Terminal (1): .250 [6.4] with .16 x .07 [4.1 x 1.8] slot. Recommended for use with mating connectors - no solder

Versatile Power Entry Module with Small Footprint *(continued)*

P Series

Case Styles *(continued)*

Shield Options



Note: Shields can only be used with filtered models. B shield may not be used with J or C extender

Recommended Panel Cutout



Note: For snap-in applications, the "A" sides must have a .020 [.508] radius on the installation side. Dimensions are for front mount applications. Rear mount dimensions should be determined based on customer's application parameters. Snap-in models allow for front mounting only. Not recommended for use in plastic panels.

Style	Dimension "A" +.008 - .000			Dimension "B" +.008 - .000	
	No Shield	Shielded	High Performance	Standard	High Performance
PM	1.06 [26.92]	1.12 [28.45]	1.12 [28.45]	2.13 [54.10]	2.201 [55.97]
PE	1.12 [28.45]	1.12 [28.45]	1.15 [29.27]	2.201 [55.97]*	2.201 [55.97]
PS	1.06 [26.92]	1.12 [28.45]	-	2.201 [55.97]*	-
PSC	1.06 [26.92]	1.12 [28.45]	-	2.52 [64.07]	-
PSJ	1.06 [26.92]	1.12 [28.45]	-	2.60 [66.04]	-
PSL	1.12 [28.45]	-	-	2.201 [55.97]*	-

*For panel thickness of 0.031 - 0.079 [.787 - 2.01] only. Use 2.213 [56.21] for panel thickness of 0.083 - 0.114 [2.0 - 2.90]

Versatile Power Entry Module with Small Footprint *(continued)*

P Series

Performance Data

Typical Insertion Loss

Measured in closed 50 Ohm system

— Common Mode / Asymmetrical (L-G)
— Differential Mode / Symmetrical (L-L)

S Models



H Models

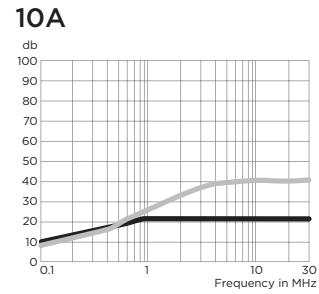
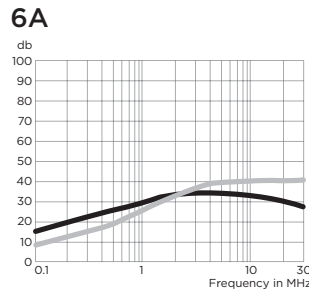
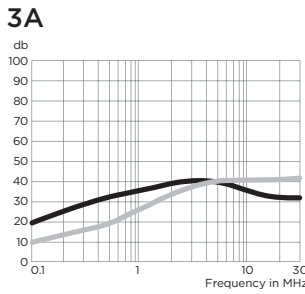

L Models



Z Models



Versatile Power Entry Module with Small Footprint *(continued)*

P Series

Minimum Insertion Loss

Measured in closed 50 Ohm system

Common Mode / Asymmetrical (Line to Ground)

Current Rating	Frequency – MHz								
	.03	.1	.15	.5	1	3	5	10	30
S Models									
3A	7	17	21	27	33	40	44	50	32
6A	-	8	12	17	23	32	36	44	30
10A	-	3	5	10	13	23	27	35	27
H Models									
3A	7	17	21	27	30	29	26	23	15
6A	-	8	11	15	17	19	18	16	13
10A	3	5	8	10	12	11	11	10	10

Differential Mode / Symmetrical (Line to Line)

Current Rating	Frequency – MHz							
	.10	.15	.5	1	3	5	10	30
S Models								
3A	2	4	12	15	30	48	50	45
6A	2	4	12	15	22	42	55	45
10A	2	4	12	15	22	42	55	45
H Models								
3A	2	4	12	18	31	40	48	41
6A	2	4	12	16	26	35	40	35
10A	2	4	12	16	26	33	40	32

Current Rating	Frequency – MHz								
	.01	.05	.1	.15	.5	1	5	10	30
L Models									
6A	8	21	27	29	34	35	25	21	16
10A	5	17	22	23	24	25	21	18	14
Z Models									
6A	8	21	27	30	37	43	49	52	42
10A	5	17	22	24	27	32	52	47	40

Current Rating	Frequency – MHz								
	.01	.05	.1	.15	.5	1	5	10	30
L Models									
6A	10	15	34	44	75	75	75	70	60
10A	10	20	20	35	67	75	75	70	60
Z Models									
6A	10	15	34	44	75	75	75	70	60
10A	10	20	20	35	67	75	75	70	60

Power Inlet Connectors

SR Series



UL Recognized
CSA Certified
VDE Approved*



SR Series

- Full Line of popular AC receptacles
- Male and female power line connectors
- Snap-in and flange mount versions
- IEC60320-1 C-13 & C14 inlets rated up to 15A
- IEC60320-1 C-19 & C-20 inlets rated up to 20A

Ordering Information



*15A versions are VDE approved at 10A, 250VAC max.
20A versions are VDE approved at 16A, 250VAC max.

Specifications

Rated Voltage (max.): 250 VAC

Materials:

- Insulator:** Thermoplastic UL 94V-0 flame rating
- Prongs:** Solid brass, nickel plated
- Terminals:** Brass, tin plated

Temperature Rating: For "cold" connections, 65°C

Available Part Numbers

Type	Male Connector	Female Connector
PC Pins	6ESRM-P	
Snap-In	6ESRMC2	6ESRFC3
Flange Mount	6ESRM-3	6ESRF-3
Snap-In	20ESRMC2	
Flange Mount	20ESRM-3	

Case Styles

6ESRM-P



Power Inlet Connectors (continued)

SR Series

Case Styles (continued)

6ESRMC2

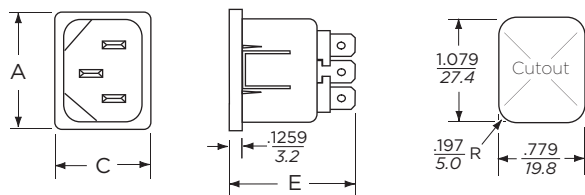

Typical Dimensions:
Front Connector: IEC 60320-1 C14
Rear Terminals: .187 [4.8] with .07 [1.8] Dia. hole

6ESRFC3

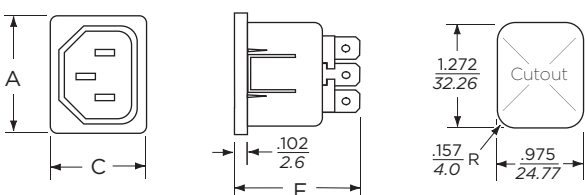

Typical Dimensions:
Front Connector: IEC 60320-1 C13
Rear Terminals: .25 [6.3] with .07 [1.8] Dia. hole

6ESRM-3

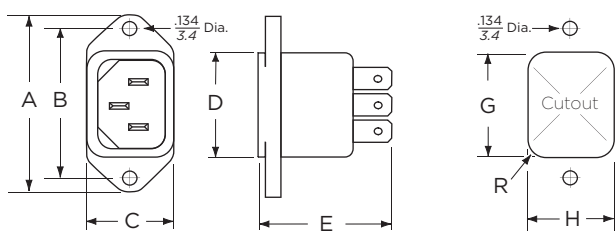

Cutout Dimensions:

	Rear Mount	Front Mount
G:	1.19 [30.23]	1.079 [27.4]
H:	0.894 [22.7]	0.779 [19.8]
R:	0.232 [5.9]	0.197 [5.0]

Typical Dimensions:
Front Connector: IEC 60320-1 C14
Rear Terminals: .25 [6.3] with .07 [1.8] Dia. hole

6ESRF-3

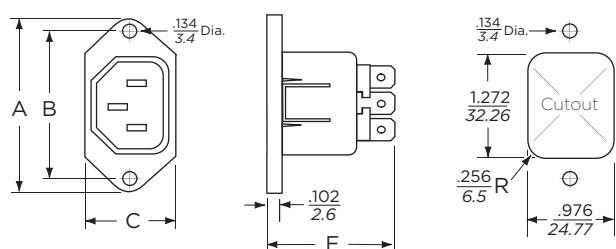

Typical Dimensions:
Front Connector: IEC 60320-1 C13
Rear Terminals: .25 [6.3] with .07 [1.8] Dia. hole

20ESRMC2

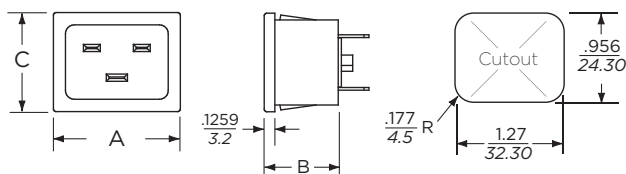

Typical Dimensions:
Front Connector: IEC 60320-1 C20
Rear Terminals: .25 [6.3] with .07 [1.8] Dia. hole

20ESRM-3

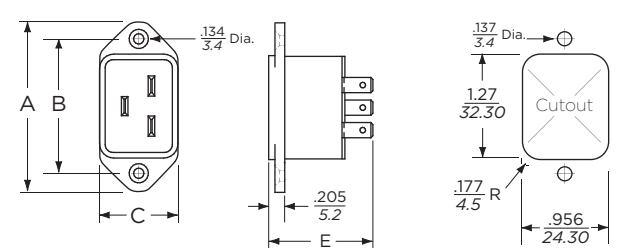

Typical Dimensions:
Front Connector: IEC 60320-1 C20
Rear Terminals: .25 [6.3] with .07 [1.8] Dia. hole

Case Dimensions

Part No.	A (max.)	B $\begin{smallmatrix} +.017 - .006 \\ +.43 - .15 \end{smallmatrix}$	C (max.)	D (max.)	E (max.)
6ESRM-P	1.96	1.575	1.094	1.118	.807
	49.8	40.0	27.8	28.39	20.5
6ESRMC2	1.182	-	.885	-	1.192
	30.00		22.5		30.3
6ESRFC3	1.39	-	1.09	-	1.496
	35.5		27.8		38.0
6ESRM-3	1.96	1.575	.885	1.19	1.275
	49.8	40.0	22.5	30.23	32.4
6ESRF-3	1.953	1.575	1.133	-	1.496
	49.6	40.0	28.8		38.0
20ESRMC2	1.377	.921	1.06	-	-
	35.0	23.4	27.0		
20ESRM-3	2.087	1.653	.999	-	1.318
	53.0	42.0	25.4		33.5

Minimum Depth, Cost-effective Shielded Power Inlet Filter

SRB Series



UL Recognized
CSA Certified
VDE Approved*



SRB Series

- Smallest depth Corcom RFI filter available
- Complete shield
- Wide range of capacitor values
- Attenuates coupled EMI up to 300MHz
- Minimal to low leakage current versions are suitable for patient and non-patient contact medical equipment.
- Full range of mounting and termination options including unique vertical and horizontal orientation slide in mounts eliminate the need for mounting hardware

Ordering Information

15 SRB S 1 - Q



*15A versions are tested by Underwriters Laboratories to US and Canadian requirements and are VDE approved at 10A, 250VAC

Specifications

Maximum leakage current each Line to Ground:

Capacitor ID / Value	@120 VAC	@250 VAC
Blank / None	2 µA	5 µA
Q / 33 pF	2.1 µA	3.65 µA
R / 100 pF	9.6 µA	16.6 µA
S / 220 pF	19.2 µA	33.2 µA
T / 330 pF	24.0 µA	41.5 µA
W / 470 pF	0.04 mA	0.07 mA
X / 1000 pF	0.07 mA	0.13 mA
Y / 2200 pF	0.16 mA	0.28 mA
Z / 3300 pF	0.24 mA	0.42 mA

Hipot rating (one minute):

Line to Ground:	2250 VDC
Line to Line:	1450 VDC

Rated Voltage (max.):

250 VAC

Operating Frequency:

50/60 Hz

Rated Current:

15A*

Operating Ambient Temperature Range

(at rated current I_r): -10°C to +40°C
In an ambient temperature (T_a) higher than +40°C the maximum operating current (I_o) is calculated as follows: $I_o = I_r \sqrt{(85-T_a)/45}$

Capacitor Options

Capacitor ID	Capacitor Value
Q	33 pF
R	100 pF
S	220 pF
T	330 pF
W	470 pF
X	1000 pF
Y*	2200 pF
Z*	3300 pF

*Not available in SRB8, SRBX or SRBY styles

Minimum Depth, Cost-effective Shielded Power Inlet Filter *(continued)*

SRB Series

Available Part Numbers

Flange Mount

15SRB1	15SRB2	15SRBP	15SRB8
15SRB1-Q	15SRB2-Q	15SRBP-Q	15SRB8-Q
15SRB1-R	15SRB2-R	15SRBP-R	15SRB8-R
15SRB1-S	15SRB2-S	15SRBP-S	15SRB8-S
15SRB1-T	15SRB2-T	15SRBP-T	15SRB8-T
15SRB1-W	15SRB2-W	15SRBP-W	15SRB8-W
15SRB1-X	15SRB2-X	15SRBP-X	15SRB8-X
15SRB1-Y	15SRB2-Y	15SRBP-Y	
15SRB1-Z	15SRB2-Z	15SRBP-Z	

Snap-In

Slide-In

15SRBS1	15SRBS8	15SRBX8	15SRBY8
15SRBS1-Q	15SRBS8-Q	15SRBX8-Q	15SRBY8-Q
15SRBS1-R	15SRBS8-R	15SRBX8-R	15SRBY8-R
15SRBS1-S	15SRBS8-S	15SRBX8-S	15SRBY8-S
15SRBS1-T	15SRBS8-T	15SRBX8-T	15SRBY8-T
15SRBS1-W	15SRBS8-W	15SRBX8-W	15SRBY8-W
15SRBS1-X	15SRBS8-X	15SRBX8-X	15SRBY8-X
15SRBS1-Y			
15SRBS1-Z			

Electrical Schematic



Accessories

GA400: NEMA 5-15P to IEC 60320-1 C-13 line cord

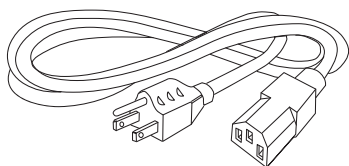

Case Styles

SRB1



Typical Dimensions:
 Mounting holes (2): .132 [3.35] Dia. with .236 [5.99] Dia. x 90° countersink for #4 flathead screw
 Line Inlet (1): IEC 60320-1 C14
 Load Terminals (2): .250 [6.3] with .07 [1.8] Dia. hole
 Ground Terminal (1): .250 [6.3] with .07 x .16 [1.8 x 3.8] slot

SRB2



Typical Dimensions:
 Mounting holes (2): .132 [3.35] Dia. with .236 [5.99] Dia. x 90° countersink for #4 flathead screw
 Line Inlet (1): IEC 60320-1 C14
 Load Terminals (2): .250 [6.3] with .07 [1.8] Dia. hole
 Ground Terminal (1): .250 [6.3] with .07 x .16 [1.8 x 3.8] slot

SRBP



Typical Dimensions:
 Mounting holes (2): .132 [3.35] Dia. with .236 [5.99] Dia. x 90° countersink for #4 flathead screw
 Line Inlet (1): IEC 60320-1 C14
 PC board pins (3): .031 [0.7] square, ± .003 [.07]

SRBS1



Typical Dimensions:
 Line Inlet (1): IEC 60320-1 C14
 Load Terminals (2): .250 [6.3] with .07 [1.8] Dia. hole
 Ground Terminal (1): .250 [6.3] with .07 x .16 [1.8 x 3.8] slot

Minimum Depth, Cost-effective Shielded Power Inlet Filter *(continued)*

SRB Series

Case Styles *(continued)*

SRB8



Typical Dimensions:
 Mounting holes (2): .132 [3.35] Dia. with .236 [5.99] Dia. x 90° countersink for #4 flathead screw
 Line Inlet (1): IEC 60320-1 C14
 Wire Leads: 4.0 [101.6] Min., 18AWG, UL1015

SRBS8



Typical Dimensions:
 Line Inlet (1): IEC 60320-1 C14
 Wire Leads: 4.0 [101.6] Min., 18AWG, UL1015

SRBX8



Typical Dimensions:
 Line Inlet (1): IEC 60320-1 C14
 Wire Leads: 4.0 [101.6] Min., 18AWG, UL1015

SRBY8



Typical Dimensions:
 Line Inlet (1): IEC 60320-1 C14
 Wire Leads: 4.0 [101.6] Min., 18AWG, UL1015

Case Dimensions

Part No.	A (max.)	B (max.)	C (max.)	D $\pm .015$ $\pm .38$	E (max.)
15SRB1	1.75	1.13	0.96	1.58	2.04
15SRB2	1.54	1.13	0.96	1.58	2.04
15SRBP	1.54	1.13	0.96	1.58	2.04
15SRBS1	1.75	1.13	0.96	1.19	1.41
15SRB8	0.95	1.13	0.96	1.58	2.04
15SRBS8	.95	1.13	0.96	1.19	1.41
15SRBX8	0.95	1.11	0.89	1.35*	1.41
15SRBY8	0.95	1.11	0.89	1.30*	1.36

*max.

Minimum Depth, Cost-effective Shielded Power Inlet Filter *(continued)*

SRB Series

Recommended Panel Cutouts

SRB1, SRB2, SRBP & SRB8



Tolerances $\pm .005$ [0.13] unless otherwise noted
 Note 1: SRB1 and SRB8 can be front or back mounted
 Note 2: SRB2 and SRBP can be back mounted only

SRBS



Front Mount only

Panel Thickness	G Dim. $\pm .002$ [05]
0.031 - 0.052 [0.79 - 1.32]	1.260 [32.00]
0.046 - 0.068 [1.17 - 1.73]	1.350 [34.29]

Tolerance $\pm .002$ [050]

SRBX



SRBY



PC Board Layout

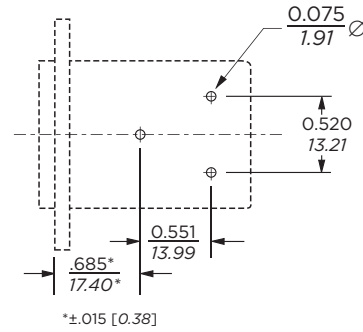

SRBX8

Minimum Depth, Cost-effective Shielded Power Inlet Filter *(continued)*

SRB Series

Performance Data

Typical Insertion Loss

Measured in closed 50 Ohm system



Minimum Insertion Loss

Measured in closed 50 Ohm system

Common Mode / Asymmetrical (Line to Ground)

Current Rating	Frequency – MHz					
	1	5	10	50	100	300
Q	-	-	-	-	-	20
R	-	-	-	3	6	22
S	-	-	1	6	17	19
T	-	-	2	13	13	19
W	-	2	4	18	13	20
X	-	5	9	25	10	17
Y	1	10	15	20	8	22
Z	2	14	18	17	7	15

Engineering Notes



4. DC Filters – Table of Contents

Introduction210
Selector Chart211
DA Series212
DB Series214
DC Series217
P Series223

Introduction

STAY CONNECTED WITH CORCOM PRODUCTS

TE Connectivity (TE) is a world leader in EMI-RFI filtering technology. Since 1955, TE has been providing EMI-RFI solutions to leading computer, industrial and telecommunications companies worldwide. Whether you are meeting FCC and international EMC standards on EMI-RFI emissions or developing a newly designed piece of equipment from being disturbed by EMI-RFI in the environment, a power line filter will help your equipment with compliance.

This section highlights TE's product offering of DC rated products. Whether the issues involve filtering noise on the data lines or on the power lines, TE can provide the needed solutions for both susceptibility and to help achieve system emissions and immunity compliance.

As new technologies in the Telecom-Datacom industry are developed and introduced, TE continues to design and develop new products to address the EMI-RFI filtering issues. TE's design engineers are very actively working with telecom and datacom system engineers to solve EMI-RFI issues.

In working with two of the leading North American communications equipment companies, TE engineers solved the EMI-RFI issues present by applying 48 VDC filters at the primary input of the DC power supply. One of the applications was on network routing equipment and required a two-stage 48VDC filter on the input to the DC power supply. TE applied high-frequency attenuating 48VDC filters on the load side of the DC power supplies to solve high-frequency EMI-RFI issues.



Typical Piece of Communications Equipment Utilizing 48VDC Filters

TE has provided solutions in both power line filtering and signal line filtering applications for many leading communications companies. As data transmission speeds increase and EMI-RFI issues multiply, TE has developed products to better solve the newer challenges communications companies encounter.

Corcom DC power line and signal line filters have been included in:

- Network routing equipment
- Servers
- Modems
- Switching equipment
- Wireless cabinets
- Ethernet hubs
- Base stations
- Repeater stations
- Power supplies for all types of communications equipment

TE has developed DC filter products specifically for the communications industry including:

- DC power line clean-up filters
- Medium and multiple-stage high-performance DC power line filters
- High frequency DC power line filters (up to 3GHz)
- High current DC power line filters (up to 60A)
- Data-transmission signal line filters

Corcom DC filters are available in versions that can solve a wide variety of EMI-RFI issues. TE has solved basic EMI-RFI issues with simple clean-up DC filters and has solved more complex EMI-RFI issues with mid-range and multiple-stage high performing DC filters. TE has also solved high-frequency noise problems (up to 3GHz) encountered with high-speed data transmission and switching power supplies.

Selector Chart



Series	Input	Output	Mounting	Options	Current Rating
<p>P</p>	2-pin Inlet	1/4" Terminal	Snap In Panel or Flange Panel	Fuse	3, 6, 10A
<p>DA / DAS</p>	3-pin Inlet	1/4" Terminal or PC Board	Snap In Panel or Flange Panel	—	3, 6, 10, 15A
<p>DB</p>	2-pin High Current Inlet	Wire Leads	Flange Panel and Rear Mount	Compact, Standard, Feedthrough & Hi-Performance Filters and Unfiltered Inlet & Plug available Separately	60A
<p>DC</p>	Redundant Stud Terminal Block	Redundant Stud or Terminal Block	Bulkhead or Flange Chassis	Circuit Breaker and/or High Frequency Performance	15, 30, 60, 100, 125A

Compact RFI Line Filter with DC Inlet Connection

DA Series



UL Recognized
CSA Certified
TUV Certified



DAFP

DAF1

DAS1

DA Series

- General purpose line filters for DC applications up to 125VDC.
- Compact with a 3-pin inlet connector
- Available in 3, 6, 10 and 15A versions
- Flange mount with 1/4" or PCB terminals
- Mates with a standard MOLEX* connector (HCS Series)

Ordering Information

3 DA F 1



Available Part Numbers

3DAF1	10DAF1
3DAS1	10DAS1
3DAFP	10DAFP
6DAF1	15DAF1
6DAS1	15DAS1
6DAFP	15DAFP

Specifications

- Hipot rating (one minute):**
Line to Ground: 2250 VDC
Line to Line: 1450 VDC
- Rated Voltage (max):** 125 VDC
- Rated Current:** 3 to 15A
- Operating Ambient Temperature Range (at rated current I_r):** -10°C to +55°C
In an ambient temperature (T_a) higher than +55°C the maximum operating current (I_o) is calculated as follows: $I_o = I_r \sqrt{(85-T_a)/45}$

Electrical Schematic

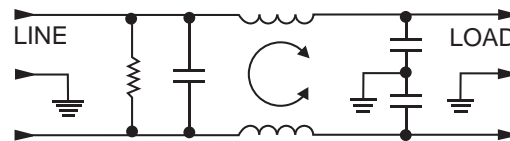

Accessories



GA310 - (shown above) Pre-assembled connector housing and terminals with three 36" long 18 gauge wires to mate with DA Series filters

MOLEX* connector part numbers:

- 03-12-1036 Connector housing for DA Series
18-12-1222 Female terminals (3 per connector)

*MOLEX is a trademark of MOLEX Incorporated

Compact RFI Line Filter with DC Inlet Connection *(continued)*

DA Series

Case Styles

DAF1



Typical Dimensions:

Load Terminals (2): .250 [6.3] with .07 [1.8] Dia. hole
 Ground Terminal (1): .250 [6.3] with .07 x .16 [1.8 x 3.8] slot
 Mounting Holes (2): .187 ± .008 [4.75 ± .20] Dia.
 90° countersunk for # 4 flathead screw

DAS1



Typical Dimensions:

Load Terminals (2): .250 [6.3] with .07 [1.8] Dia. hole
 Ground Terminal (1): .250 [6.3] with .07 x .16 [1.8 x 3.8] slot

DAFP



Typical Dimensions:

Pins (3): .031 x .06 ± .003
 Mounting Holes (2): 0.187 ± .008 [4.75 ± .20] Dia.
 90° countersunk for # 4 flathead screw

PC Board Layout



Case Dimensions

Part No.	A (max.)	B (max.)	C (max.)	D $\pm .010$ $\pm .25$	E (max.)
DAF1	2.15 54.61	1.12 28.45	0.81 20.57	1.575 40.01	1.98 50.29
DAS1	1.98 50.29	1.10 27.94	0.81 20.57	0.96* 24.38	1.41 35.81
DAFP	1.54 39.12	1.12 28.45	0.81 20.57	1.575 40.01	1.98 50.29

*Represents max. dimension

Recommended Panel Cutouts

DAF



DAS



Performance Data

Minimum Insertion Loss

Measured in closed 50 Ohm system

Common Mode / Asymmetrical (Line to Ground)

Current Rating	Frequency – MHz										
	.05	.1	.15	.5	1	3	5	10	30	100	200
3A	6	9	11	26	41	48	52	55	46	22	16
6A	2	4	6	18	30	37	42	48	42	-	-
10A	-	1	4	8	17	25	30	36	38	21	11
15A	-	-	-	3	5	13	19	25	29	10	14

Differential Mode / Symmetrical (Line to Line)

Current Rating	Frequency – MHz										
	.05	.1	.15	.5	1	3	5	10	30	100	200
3A	-	4	7	16	18	37	47	50	43	31	36
6A	-	4	7	19	21	27	40	53	41	-	-
10A	2	4	6	17	22	23	32	48	38	30	26
15A	-	-	2	17	19	29	33	37	37	31	28

Compact RFI High Current DC Inlet Connection

DB Series



UL Recognized
CSA Certified
TUV Certified



DB Series

- Compact connector for high-current DC applications
- Reliable performance in a compact assembly
- Polarized mating scheme
- Easy customer termination of power source
- Plug and receptacle available pre-terminated in standard wire lengths
- Available filtered or unfiltered

Ordering Information



Specifications

Hipot rating (one minute):

	Filtered Models	DBR & DBP
Line to Ground:	2121 VDC	n/a
LIne to Line:	1768 VDC	1600 VAC

Rated Voltage (max): 150VDC* 300 VDC

Rated Current: 60A (*all versions*)

Operating Ambient Temperature Range (at rated current I_r): -10°C to +55°C
 In an ambient temperature (T_a) higher than +55°C the maximum operating current (I_O) is calculated as follows: I_O = I_r √(85-T_a)/30

*Certified to 120V for TUV

Available Part Numbers

Filtered Models	
60DB8	60DBJ8
60DBF8	60DBX8

Connectors Only	
60DBR	60DBP
60DBRL1	60DBPL1
60DBRL3	60DBPL3
	60DBPL9

WARNING
This is not approved for hot swap or current interruption in DC applications. Doing so will result in irreparable damage to contacts.

Compact RFI High Current DC Inlet Filter (continued)

DB Series

Electrical Schematics

DB8 & DBJ8



DBF8

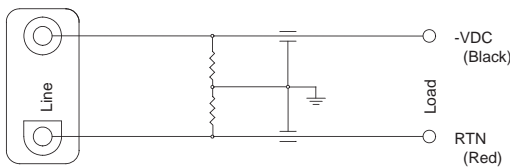

DBX8



60DBPL

60DBRL

Available as connector only (shown)
or with pre-installed 6AWG 300V Extra Flexible wire

Case Styles

DBJ8

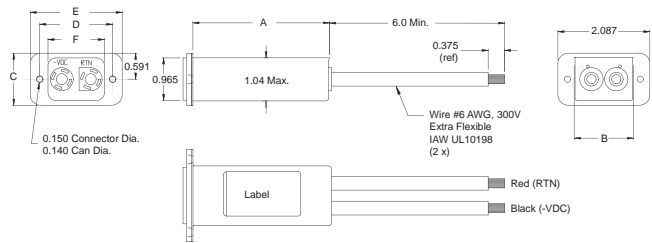

DB8 & DBF8



DBX8



4
DC Filters

Compact RFI High Current DC Inlet Filter *(continued)*

DB Series

Case Styles *(continued)*

DBPL



DBRL



Recommended Panel Cutout

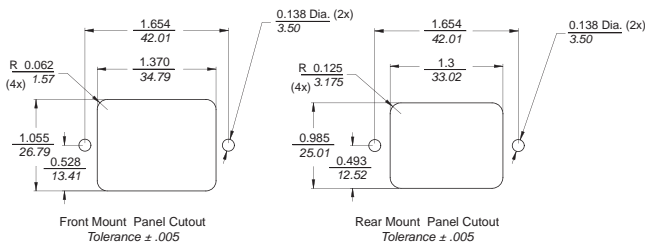

Minimum cable lengths:

DBRL1 / DBPL1:	12 [304.8]
DBRL3 / DBPL3:	36 [914.4]
DBPL9:	108 [2743.2]

Accessories / Tooling

Insertion/Extraction Tool:	1643922-1*
Crimp per TE spec:	114-13206
Crimp tool:	M22520/23-01
Indenter head:	M22520/23-04
Locator:	M22520/23-11
Connector system locking kit ¹ :	Contact TE

*for DBR / DBP Only

¹Tool required to disengage mated connector when using locking kit

Case Dimensions

Part No.	A	B	C	D	E	F
	(max)	(max)	$\frac{\pm.025}{\pm.635}$	$\frac{\pm.025}{\pm.635}$	$\frac{\pm.025}{\pm.635}$	$\frac{\pm.025}{\pm.635}$
60DBJ8	3.2	1.36	1.181	1.654	2.087	1.28
60DB8	4.06	3.20	1.45	2.50	0.875	2.077
60DBF8	<i>103.12</i>	<i>81.28</i>	<i>36.83</i>	<i>63.50</i>	<i>22.23</i>	<i>52.76</i>
60DBX	6.06	3.50	1.45	2.876	0.875	2.265
60DBRL	1.22*	1.181*	2.087	1.654	1.023	0.591
60DBPL	1.695*	0.93*	2.08	1.654	1.195	0.465

*± 0.025 [0.635]

Performance Data

Minimum Insertion Loss

Measured in closed 50 Ohm system

Common Mode / Asymmetrical (Line to Ground)

Part No.	Frequency – MHz									
	0.1	0.15	0.5	1	5	1	20	30	50	100
60DBJ8	-	-	-	1	13	21	30	40	30	20

Part No.	Frequency – MHz									
	0.05	0.1	0.15	.5	1	3	5	10	20	30
60DB8	2	7	10	23	30	48	38	28	20	16
60DBF8	15	22	25	35	42	50	58	54	38	36
60DBX8	-	10	16	40	48	54	60	51	40	36

Differential Mode / Symmetrical (Line to Line)

Part No.	Frequency – MHz									
	0.1	0.15	0.5	1	5	1	20	30	50	100
60DBJ8	5	8	19	26	34	26	20	16	-	-

Part No.	Frequency – MHz									
	0.05	0.1	0.15	.5	1	3	5	10	20	30
60DB8	20	26	29	43	53	30	30	24	20	18
60DBF8	9	15	18	30	34	40	44	44	48	52
60DBX8	31	30	30	70	70	54	50	60	54	50

RFI Power Line Filters for DC Applications

DC Series



UL Recognized
CSA Certified
TUV Certified



60DCF6B



15DCF10

DC Series

- General purpose line filters for DC applications up to 125VDC
- Available with or without a circuit breaker
- Available with feedthrough capacitors for added high frequency performance
- Available in both flange mound (DCF) and bulkhead mount (DCB) configuration

Ordering Information

60 DC B 6 B

Options

- B - Circuit breaker
- F - Feedthrough capacitors
- BF - Circuit breaker and feedthrough
- F and BF available only in bulkhead (B) mounting style*
- Omit for none

Input / Output Styles

- 6 - Redundant stud
- 10 - Phoenix terminal

Mounting Style

- F = Flange
- B = Bulkhead and rack
- Required for F or BF options*

DC Series

- Current Rating
- 15, 30, 60, 100 or 125A

Specifications

Hipot rating (one minute):

Line to Ground:	2250 VDC
Line to Line:	1450 VDC

Rated Voltage (max):

80 VDC

Rated Current:

15 to 125A

Operating Ambient Temperature Range

(at rated current I_r): -10°C to +55°C

In an ambient temperature (T_a) higher than +55°C the maximum operating current (I_o) is calculated as follows: $I_o = I_r \sqrt{(85-T_a)/30}$

Electrical Schematics

Standard Performance

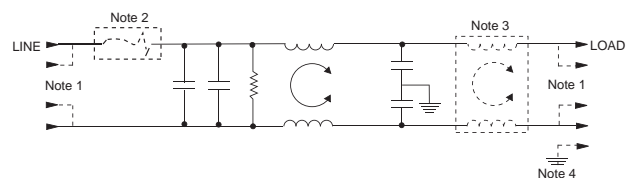

High Frequency Performance (F & BF Styles)

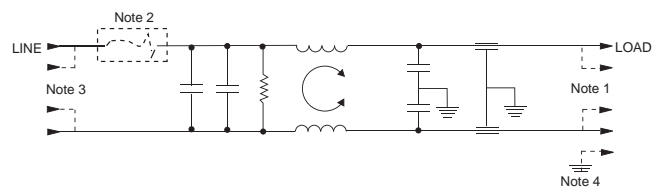

- Note 1: Depicts redundant style 6 terminals.
- Note 2: Depicts optional circuit breaker.
- Note 3: For 100 & 125A versions delete second coil.
- Note 4: Depicts style 10 terminal versions which have separate ground stud.

RFI Power Line Filters for DC Applications *(continued)*

DC Series

Available Part Numbers

Standard Performance		High Performance	
15DCF6	15DCF10	15DCB10F	15DCB6F
30DCF6	30DCF10	30DCB10F	30DCB6F
60DCF6	60DCF10	60DCB10F	60DCB6F
100DCF6	100DCF10	100DCB10F	100DCB6F
125DCF6	125DCF10	125DCB10F	125DCB6F
15DCF6B	15DCF10B	15DCB6BF	
30DCF6B	30DCF10B	30DCB6BF	
60DCF6B	60DCF10B	60DCB6BF	
100DCF6B	100DCF10B	100DCB6BF	
125DCF6B	125DCF10B	125DCB6BF	
15DCB6	15DCB10	15DCB10BF	
30DCB6	30DCB10	30DCB10BF	
60DCB6	60DCB10	60DCB10BF	
100DCB6	100DCB10	100DCB10BF	
125DCB6	125DCB10	125DCB10BF	
15DCB6B	15DCB10B		
30DCB6B	30DCB10B		
60DCB6B	60DCB10B		
100DCB6B	100DCB10B		
125DCB6B	125DCB10B		

Termination Options

Style 6 (15, 30 & 60A)

- Supplied with #10-32 redundant studs
- 0.625 [15.88] spacing like polarity
- 0.750 [19.05] spacing opposing polarity
- Torque specification: 27 ±3 in-lb.

Style 10 (15 & 30A)

- PHOENIX CONTACT* part number: VDFK4
- Accepts 12 AWG stranded wire
- Wire strip length: 0.315 [8.0]
- Torque specification: 5.5 – 7.0 in-lb.
- Ground stud: 8-32

Style 10 (100A)

- PHOENIX CONTACT* part number: HDFK 25-VP
- Accepts 4 AWG stranded wire
- Wire strip length: 0.748 [19.0]
- Torque specification: 35.4 – 39.9 in-lb.
- Ground stud: 1/4-20

Style 6 (100 & 125A)

- Supplied with 1/4-20 redundant studs
- 0.750 [19.05] spacing like polarity
- 1.00 [25.4] spacing opposing polarity
- Torque specification: 45 ±2 in-lb

Style 10 (60A)

- PHOENIX CONTACT* part number: HDFK 16-VP
- Accepts 6 AWG stranded wire
- Wire strip length: 0.630 [16.0]
- Torque specification: 17.7 – 21.2 in-lb.
- Ground stud: 10-32

Style 10 (125A)

- PHOENIX CONTACT* part number: HDFK 50-VP
- Accepts 1 AWG stranded wire
- Wire strip length: 0.945 [24.0]
- Torque specification: 35.4 – 39.9 in-lb.
- Ground stud: 1/4-20

*PHOENIX CONTACT is a trademark of Phoenix Contact GmbH & Co. KG.

RFI Power Line Filters for DC Applications *(continued)*

DC Series

Recommended Panel Cutouts

DCB6(F) & DCB10(F)



DCB6B(F) & DCB10B(F) 15 to 60A



DCB6B(F) & DCB10B(F) 100 to 125A



Cutout Dimensions

DCB6(F) & DCB10(F)

Part No.	A	B	C
15DCB6(F)	1.375	1.249	3.472
30DCB6(F)	34.93	31.72	88.19
15DCB10(F)	1.250	1.000	3.472
30DCB10(F)	31.75	25.40	88.19
60DCB6(F)	1.375	1.249	3.472
	34.93	31.72	88.19
60DCB10(F)	1.674	1.010	3.443
	42.52	25.65	87.45
100DCB6(F)	1.700	1.549	3.472
125DCB6(F)	43.18	39.34	88.19
100DCB10(F)	1.954	1.500	2.830
	49.63	38.10	71.20
125DCB10(F)	2.250	1.590	2.725
	57.15	40.39	69.22

DCB6B(F) & DCB10B(F) 15 to 60A

Part No.	A	B	C	D	E	F
15DCB6B(F)	1.50	0.781	1.308	3.472	1.375	1.249
15DCF6B	38.10	19.84	33.22	88.19	34.93	31.72
15DCB10B(F)	1.50	0.781	1.308	3.472	1.250	1.00
15DCF10B	38.10	19.84	33.22	88.19	31.75	25.40
30DCB6B(F)	1.50	0.781	1.308	3.472	1.375	1.249
30DCF6B	38.10	19.84	33.22	88.19	34.93	31.72
30DCB10B(F)	1.50	0.781	1.308	3.472	1.250	1.00
30DCF10B	38.10	19.84	33.22	88.19	31.75	25.40
60DCB10B(F)	1.50	0.781	1.308	3.443	1.674	1.010
60DCF10B	38.10	19.84	33.22	87.45	42.52	25.65
60DCF6B(F)	1.50	0.781	1.308	3.472	1.375	1.249
60DCF6B	38.10	19.84	33.22	88.19	34.93	31.72

DCB6B(F) & DCB10B(F) 100 to 125A

Part No.	A	B	C
100DCB6B(F)	1.70	1.549	4.222
100DCF6B			
125DCB6B(F)	43.18	39.34	107.23
125DCF6B			
100DCB10B(F)	1.954	1.50	4.295
100DCF10B	49.63	38.10	109.09
125DCB10B(F)	2.25	1.59	4.147
	57.15	40.39	105.33
125DCF10B	2.25	1.59	2.725
	57.15	40.39	105.33

RFI Power Line Filters for DC Applications *(continued)*

DC Series

Case Styles

DCB6 & DCB6B



DCB10 & DCB10B (60 to 125A)



DCF6



DCF10 (15 & 30A)



DCF6B



DCF10 (60 to 125A)



DCB10 & DCB10B (15 to 30A)



DCF10B (15 & 30A)



RFI Power Line Filters for DC Applications *(continued)*

DC Series

Case Styles *(continued)*

DCF10B (60 TO 125A)



Typical Dimensions:
Mounting Slots (4): .260 x .39 [6.6 x 9.9]

Case Dimensions

Part No.	A (max)	B (max)	C (max)	D ± 0.20 $\pm .51$	E (max)	F ± 0.20 $\pm .51$
15DCB6(F)	5.69	5.06	1.48	4.50	4.06	0.950
15DCB6B(F)	7.69	5.06	1.48	4.50	6.06	0.950
15DCB10(F)	5.06	5.06	1.48	4.50	4.06	0.950
15DCB10B(F)	7.06	5.06	1.48	4.50	6.06	0.950
15DCF6	5.33	3.10	1.78	2.677	3.70	2.00
15DCF6B(F)	7.69	5.06	1.48	5.740	6.06	3.52
15DCF10	4.75	3.10	1.78	2.677	3.70	2.0
15DCF10B(F)	7.06	5.06	1.48	5.740	6.06	3.520
30DCB6(F)	7.69	5.06	1.48	4.50	6.06	0.95
30DCB6B(F)	8.69	5.06	1.48	4.50	7.06	0.95
30DCB10(F)	7.06	5.06	1.48	4.50	6.06	0.95
30DCB10B(F)	8.06	5.06	1.48	4.50	7.06	0.95
30DCF6	6.19	3.96	2.18	3.50	4.56	2.00
30DCF6B	8.69	5.0	1.48	5.74	7.06	4.52
30DCF10	5.56	3.96	2.18	3.5	4.56	2.0
30DCF10B	8.06	5.06	1.48	5.74	7.06	4.52

Case Dimensions *(continued)*

Part No.	A (max)	B (max)	C (max)	D ± 0.20 $\pm .51$	E (max)	F ± 0.20 $\pm .51$
60DCB6(F)	8.69	5.06	1.48	4.50	7.06	0.95
60DCB6B(F)	10.69	5.06	1.48	4.50	9.06	0.95
60DCF6	7.56	5.48	2.55	4.92	5.94	2.756
60DCF6B	10.69	5.06	1.48	5.74	9.06	6.52
60DCF10	8.56	5.48	2.55	4.92	5.94	2.576
60DCF10B	11.75	5.06	1.48	5.74	9.06	6.52
100DCB6(F)	10.31	5.06	1.78	4.50	8.06	1.25
100DCB6B(F)	12.31	6.06	1.78	5.50	10.06	1.25
100DCB10(F)	11.13	5.06	1.78	4.50	8.06	1.25
100DCB10B(F)	13.13	6.06	1.78	5.50	10.06	1.25
100DCF6	10.60	6.30	2.52	5.70	8.46	4.52
100DCF6B	12.31	6.06	1.78	6.74	10.06	7.52
100DCF10	11.50	6.30	2.52	5.70	8.46	4.52
100DCF10B	13.13	6.06	1.78	6.74	10.06	7.52
125DCB6(F)	10.31	5.06	1.78	4.50	8.06	1.25
125DCB6B(F)	12.31	6.06	1.78	5.50	10.06	1.25
125DCB10(F)	11.50	5.06	1.78	4.50	8.06	1.25
125DCB10B(F)	13.50	6.06	1.78	5.50	10.06	1.25
125DCF6	10.60	6.30	2.52	5.70	8.46	4.52
125DCF6B	12.31	6.06	1.78	6.74	10.06	7.52
125DCF10	11.86	6.30	2.52	5.70	8.46	4.52
125DCF10B	13.50	6.06	1.78	6.74	10.06	7.52

4
DC Filters

Dimensions are in inches and millimeters unless otherwise specified. Values in italics are metric equivalents. Dimensions are shown for reference purposes only. Specifications subject to change.

For email, phone or live chat, please go to te.com/help
corcom.com

RFI Power Line Filters for DC Applications *(continued)*

DC Series

Performance Data *(continued)*

Minimum Insertion Loss

Measured in closed 50 Ohm system

Standard Performance

Common Mode / Asymmetrical (Line to Ground)

Current Rating	Frequency – MHz									
	.01	.05	.1	.15	.5	1	3	5	10	30
15A	-	1	12	20	41	45	61	63	47	39
30A	-	4	15	23	47	59	64	56	44	36
60A	-	-	9	17	38	40	59	50	39	34
100A	-	-	10	18	38	39	53	50	35	21
125A	-	-	12	18	30	32	44	49	29	18

Differential Mode / Symmetrical (Line to Line)

Current Rating	Frequency – MHz									
	.01	.05	.1	.15	.5	1	3	5	10	30
15A	7	22	27	30	30	36	56	49	38	31
30A	7	22	28	31	32	59	56	51	41	28
60A	15	30	36	40	40	35	60	51	39	32
100A	14	29	35	39	33	30	53	53	41	30
125A	14	24	35	39	40	28	53	60	42	33

High Frequency Performance (F & BF Styles)

Common Mode / Asymmetrical (Line to Ground)

Current Rating	Frequency – MHz											
	.01	.05	.1	.15	.5	1	3	5	10	20	300	3000
15A	-	1	12	20	41	45	55	50	45	25	50	30
30A	-	4	15	20	46	58	60	60	48	35	50	30
60A	-	-	9	16	38	42	52	60	48	26	40	30
100A	-	-	9	16	38	42	52	60	42	26	40	30
125A	-	-	9	16	28	34	46	54	34	34	40	30

Differential Mode / Symmetrical (Line to Line)

Current Rating	Frequency – MHz									
	.01	.05	.1	.15	.5	1	3	5	10	20
15A	7	22	27	30	30	50	60	60	60	36
30A	7	22	27	30	33	56	60	60	60	40
60A	15	30	36	40	37	26	46	54	48	30
100A	14	29	35	39	33	30	56	53	41	30
125A	14	29	35	39	40	28	53	60	42	33

The CHAMELEON Adaptable Module for DC Applications

P Series



UL Recognized
CSA Certified
TUV Certified



P Series

- Full flexibility of design in the most compact package
- General purpose designed for DC applications
- Mates with a standard MOLEX* connector (HCS Series) which prevents accidental connection to AC Power

Ordering Information

PS000DD3D



Specifications

Hipot rating (one minute):	
Line to Ground:	2250 VDC
Line to Line:	1450 VDC
Rated Voltage (max):	80 VDC
Rated Current:	3 to 10A
Fuseholder*:	.25 x 1.25" or 5 x 20 mm
Terminals:	.187 x .032 [4.8 x .87] terminal tabs
Operating Ambient Temperature Range (at rated current I_r):	-10°C to +40°C
In an ambient temperature (T _a) higher than +40°C the maximum operating current (I _o) is calculated as follows: $I_o = I_r \sqrt{(85-T_a)/45}$	

*Holds one or two fuses. Conversion clip provided on fuseholder for single fuse models.

Electrical Schematic



Available Part Numbers

PE000DD3D	PS000DD3D
PE000DD6D	PS000DD6D
PE000DDXD	PS000DDXD
PE000SD3D	PS000SD3D
PE000SD6D	PS000SD6D
PE000SDXD	PS000SDXD

*MOLEX is a trademark of MOLEX Incorporated

The CHAMELEON Adaptable Module for DC Applications *(continued)*

P Series

Case Styles

PE



PS



Accessories



GA210 - (shown above) Pre-assembled connector housing with two 36" long 18 gauge wires to mate with P Series DC filters

MOLEX Part Numbers:

- 03-12-1026 DC Connector housing for P Series
- 18-12-1222 Female terminals (2 per connector)

Case Dimensions

Part No.	A	B	C	D	E	F
	(max.)	(max.)	(max.)	*see note	*see note	(ref.)
PE	1.98 <i>50.29</i>	2.13 <i>54.10</i>	2.31 <i>58.67</i>	1.12 <i>28.45</i>	2.201 <i>55.91</i>	1.575 <i>40.0</i>
PS	1.24 <i>31.50</i>	2.13 <i>54.10</i>	2.31 <i>58.67</i>	1.06 <i>26.93</i>	2.201 <i>55.91</i>	-

**+.008 / -.000 [+.20 / -.00]*

Recommended Panel Cutouts

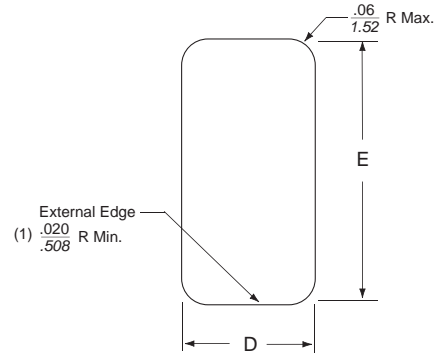

Note: The external edges (installation side) on the "D" sides of the cutout should have a minimum .020" radius. For optimal retention against extraction, the corresponding inner edge should be sharp, without paint or coatings. Edge coatings, including anodization are also discouraged for good shield contact.

Performance Data

Minimum Insertion Loss

Measured in closed 50 Ohm system

Common Mode / Asymmetrical (Line to Ground)

Current Rating	Frequency – MHz								
	.03	.1	.15	.5	1	3	5	10	30
3A	7	17	21	27	33	40	44	50	32
6A	-	8	12	17	23	32	36	44	30
15A	-	3	5	10	13	23	27	35	27

Differential Mode / Symmetrical (Line to Line)

Current Rating	Frequency – MHz							
	.1	.15	.5	1	3	5	10	30
3A	2	4	12	15	30	48	50	45
6A	2	4	12	15	22	42	55	45
15A	2	4	12	15	22	42	55	45

5. Feedthrough Filters and Capacitors – Table of Contents

Feedthrough Application Selector Chart225
Introduction226
 FFA Series228
 FFD Series231
 AFC Series234
 DFC Series237

Feedthrough Application Selector Chart



Introduction - Corcom Feedthrough Filters and Capacitors

Installation, Background and Safety

Feedthrough capacitors and filters are designed for through-bulkhead mounting for offering high frequency filtering in line-to-ground applications. They should be mounted through a metal bulkhead or chassis. The bulkhead mounting surface should be clean and unpainted to offer a low impedance path from the capacitor or filter to the equipment chassis. Poor earth bonding will limit the available performance of the product and could compromise safety.

Conductive paint finishes should be avoided as they do not usually provide adequate conductivity. Two wrenches (or spanners) should be used when making electrical connections to the terminals and maximum tightening torque figures quoted should be observed.

Relevant safety standards have been adhered to in the design and manufacture of these products. However, all capacitors will store charge after power has been removed and must be treated with respect as this can be lethal when the voltage and charge are high enough. The filters and capacitors contained within this catalog do not contain internal discharge resistors. It is therefore recommended that they are fitted with external discharge resistors to discharge the capacitors after the power has been removed. Where necessary, terminals should be enclosed by the user to prevent any danger of electric shock or accidental shorting. In all cases, capacitors and filters should always be shorted to earth prior to touching to ensure they are fully discharged.

The user should ensure he/she is familiar with restrictions on capacitance value, earth leakage current, test voltage, and safety labeling requirements, which may be applicable to his/her particular installation. In particular, safety standards IEC950 and EN60950, which most electrical equipment needs to comply with, contain a number of specific requirements for capacitors, which may be applicable.

Applications

Offers reliability and performance in high frequency applications such as:

- Servers
- Base stations
- Routers
- Main power supplies
- Telecom systems / racks
- MRI rooms
- High power microwave lines
- Military vehicles and equipment
- High current switch mode power supplies
- Power amplifier and generators
- Industrial controls
- Screened rooms
- High frequency welding equipment
- Secure communications
- Computer facilities

Key Features

- Designed to meet EN133200 and EN132400 safety requirements
- Custom designs available where special packaging, mounting, terminations, or multiple lines are required.
- RoHS compliant

Introduction - Corcom Feedthrough Filters and Capacitors

Feedthrough Capacitor Performance

- Normal two-terminal capacitors resonate with their lead inductance in the region of 1 to 10MHz
- This limits their use as suppression components above a few MHz
- Feedthrough capacitors have no major resonance as they have no lead inductance
- Performance continues to increase with frequency
- Feedthrough capacitors are essential for good high frequency performance
- Feedthrough filters incorporate feedthrough capacitors for the same benefits
- As an example, the graph in Figure 1 compares the performance of a 1 μ F feedthrough capacitor with a 1 μ F two-terminal capacitor

Figure 1: Feedthrough Filters Performance



AC Feedthrough Filters - Class Y2

FFA Series



Component Recognized by
UL to US and Canadian Requirements



FFA Series

- AC feedthrough filters
- Current Ratings from 10 to 300A
- Designed to meet the very stringent safety requirements of EN133200 class Y2 including the 5000V pulse test
- Custom versions available

Ordering Information

10 FFA6 - BA



Filter Options / Specifications

Filter ID	Value (nF)	Inductance (nH)	Max. Leakage Current (mA)*	DC Resistance (mΩ) Max.
BA	2 x 4.7	70	0.9	6
CA	2 x 10	70	1.9	4
CE	2 x 10	140	1.9	7
DG	2 x 22	170	4.2	4
DH	2 x 22	180	4.2	4
GB	2 x 47	80	8.9	3
GJ	2 x 47	210	8.9	9
HC	2 x 100	90	19	2
HD	2 x 100	120	19	1
HF	2 x 100	160	19	< 1
HN	2 x 100	250	19	6
JK	2 x 150	240	29	3
NP	2 x 470	330**	89	< 2
PP	2 x 1000	330	188	< 2

*@ 250 VAC 60 Hz
**240 for 100A Version

Specifications

- Rated Voltage (max):** 250 VAC
- Operating Frequency:** 50/60 Hz
- Rated Current:** 10 to 300A
- Test Voltage (two seconds):** 5000 VDC
- Capacitor Class (EN133200):** Designed to meet Y2
- Pulse Test (EN133200):** 5000V Peak
- Insulation Resistance (within 1 minute):**
For C < 0.33μF, R > 15000MΩ
For C > 0.33μF, RC(MΩ*μF) > 5000s
- Operating Ambient Temperature Range (at rated current I_r):**
10 to 100A: -40°C to +60°C
200A: -40°C to +50°C
250 & 300A: -40°C to +40°C
- Category Temperature Range:** -40°C to +85°C
- Current Derating Above Ambient:**
10-100A: For temperature, θ I_θ = IR √(85-θ)/25
200A: For temperature, θ I_θ = IR √(85-θ)/35
250 & 300A: For temp., θ I_θ = IR √(85-θ)/45
- Climatic Category:** 40/85/21
- MTBF:** > 5 million hours typical
- Insulating Materials Flammability Rating:** UL94V-0
- Case & Terminal Material:** Nickel Plated Brass

Electrical Schematic



AC Feedthrough Filters - Class Y2 *(continued)*

FFA Series

Case Style

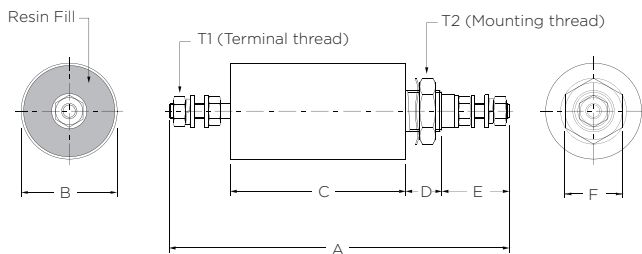

T1 - Terminal Thread

Part No.	Thread	Torque max. in.lb.
10FFA6-BA/CE/CJ	M3	4
16FFA6-CA/DG/HN	M4	11
32FFA6-CA/DH/HN	M6	22
63FFA6-GB/JK/NP	M8	44
100FFA6-HC/NP/PP	M10	70
200FFA6-HD/NP/PP	M12	97
300FFA6-HF/NP/PP	M16	177

T2 - Mounting Thread

Part No.	Thread	Torque max. in.lb.
10FFA6-BA/CE/CJ	M12 x 1	35
16FFA6-CA	M16 x 1	62
32FFA6-CA	M20 x 1	89
16FFA6-DG/HN	M24 x 1	124
32FFA6-DH/HN	M27 x 1.5	142
63FFA6-GB	M32 x 1.5	212
63FFA6-JK		
100FFA6-HC		
100FFA6-NP		
200FFA6-HD		
63FFA6-NP		
100FFA6-PP		
200FFA6-NP/PP		
250FFA6-HF/NP/PP		
300FFA6-HF/NP/PP		

Case Dimensions

Part No.	A	B	C	D	E	F
	$\frac{\pm .04}{1}$	$\frac{\pm .02}{0.5}$	$\frac{\pm .08}{2}$	$\frac{\pm .04}{1}$	$\frac{\pm .08}{2}$	(max)
10FFA6-BA	3.86 98	0.79 20	2.24 57	0.47 12	0.63 16	0.67 17
16FFA6-CA	4.17	0.79	2.40	0.47	0.71	0.67
32FFA6-CA	106	20	61	12	18	17
63FFA6-GB	6.30 160	0.98 25	3.70 94	0.55 14	1.02 26	0.87 22
100FFA6-HC	7.24 184	1.26 32	4.09 104	0.63 16	1.26 32	1.06 27
200FFA6-HD	8.23 209	1.50 38	4.41 112	0.75 19	1.57 40	1.06 27
300FFA6-HF	7.87 200	2.13 54	3.66 93	0.75 19	1.81 46	1.57 40
10FFA6-CE	4.21 107	0.79 20	2.60 66	0.47 12	0.63 16	0.67 17
16FFA6-DG	4.57	0.98	2.72	0.55	0.71	0.87
32FFA6-DH	116	25	69	14	18	22
63FFA6-JK	6.81 173	1.26 32	4.13 105	0.63 16	1.02 26	1.06 27
100FFA6-NP	8.98 228	1.50 38	5.71 145	0.75 19	1.26 32	1.06 27
200FFA6-NP	9.57 243	2.13 54	5.75 146	0.75 19	1.57 40	1.57 40
250FFA6-NP	10.51	2.13	6.30	0.75	1.81	1.57
300FFA6-HN	267	54	160	19	46	40
10FFA6-GJ	5.51 140	0.79 20	3.90 99	0.47 12	0.63 16	0.67 17
16FFA6-HN	5.83	0.98	3.98	0.55	0.71	0.87
32FFA6-HN	148	25	101	14	18	22
63FFA6-NP	7.44 189	2.13 54	4.65 118	0.75 19	1.02 26	1.57 40
100FFA6-PP	8.94 227	2.13 54	5.67 144	0.75 19	1.26 32	1.57 40
200FFA6-PP	9.57 243	2.13 54	5.75 146	0.75 19	1.57 40	1.57 40
250FFA6-PP	10.51	2.13	6.3	0.75	1.81	1.57
300FFA6-PP	267	54	160	19	46	40

Dimensions are in inches and millimeters unless otherwise specified. Values in italics are metric equivalents. Dimensions are shown for reference purposes only. Specifications subject to change.

For email, phone or live chat, please go to te.com/help or corcom.com

AC Feedthrough Filters - Class Y2 *(continued)*

FFA Series

Available Part Numbers

Standard Performance	High Performance	Extended Performance
10FFA6-BA	10FFA6-CE	10FFA6-GJ
16FFA6-CA	16FFA6-DG	16FFA6-HN
32FFA6-CA	32FFA6-DH	32FFA6-HN
63FFA6-GB	63FFA6-JK	63FFA6-NP
100FFA6-HC	100FFA6-NP	100FFA6-PP
200FFA6-HD	200FFA6-NP	200FFA6-PP
250FFA6-HF	250FFA6-NP	250FFA6-PP
300FFA6-HF	300FFA6-NP	300FFA6-PP

Performance Data

Typical Insertion Loss – Line to Ground in 50 Ohm circuit

Filter ID	Frequency – MHz								
	0.01	0.03	0.1	0.3	1	10	100	1000	
BA	-	-	-	-	4	18	80	100	
CA	-	-	2	4	10	22	65	100	
CE	-	-	2	3	10	28	65	100	
DG	-	-	3	7	15	40	72	100	
DH	-	-	3	7	15	40	72	100	
GB	-	-	6	11	21	50	85	100	
GJ	-	-	5	12	21	60	90	100	
HC	-	2	10	18	27	60	100	100	
HD	-	2	10	18	27	60	100	100	
HF	-	2	10	18	27	60	100	100	
HN	2	4	10	17	24	75	90	100	
JK	3	8	15	21	28	72	100	100	
NP	7	15	24	31	44	80	100	100	
PP	12	20	29	33	56	80	100	100	

DC Feedthrough Filters - Class Y4

FFD Series



Component Recognized by
UL to US and Canadian Requirements



FFD Series

- DC feedthrough filters
- Current ratings from 10 to 200A
- Designed to meet the very stringent safety requirements of EN133200 class Y4 including the 2500V pulse test
- Custom versions available

Ordering Information

10 FFD6 - CA

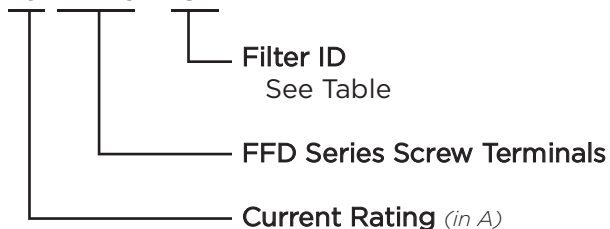

Filter Options / Specifications

Filter ID	Value (nF)	Inductance (nH)	DC Resistance (mΩ) Max.
CA	2 x 10	70	6
HB	2 x 100	80	3
HE	2 x 100	140	8
NC	2 x 470	90	2
ND	2 x 470	120	1
NH	2 x 470	180	3
PK	2 x 1000	240	2
RP	2 x 4700	330	2

Specifications

- Rated Voltage (max):** 130 VDC
- Rated Current:** 10 to 200A
- Test Voltage (two seconds):** 2500 VDC
- Capacitor Class (EN133200):** Designed to meet Y4
- Pulse Test (EN133200):** 2500V Peak
- Insulation Resistance (within 1 minute):**
For C < 0.33μF, R > 15000MΩ
For C > 0.33μF, RC(MΩ*μF) > 5000s
- Operating Ambient Temperature Range (at rated current I_r):**
10 to 100A: -40°C to +60°C
200A: -40°C to +50°C
- Category Temperature Range:** -40°C to +85°C
- Current Derating Above Ambient:**
10-100A: For temperature, θ I_θ = IR √(85-θ)/25
200A: For temperature, θ I_θ = IR √(85-θ)/35
- Climatic Category:** 40/85/21
- MTBF:** > 5 million hours typical
- Insulating Materials Flammability Rating:** UL94V-0
- Case & Terminal Material:** Nickel Plated Brass

Electrical Schematic

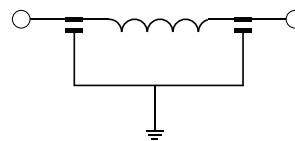

DC Feedthrough Filters - Class Y4 (continued)

FFD Series

Case Style



T1 - Terminal Thread

Part No.	Thread	Torque max. in.lb.
10FFD6-CA/HE	M3	4
16FFD6-CA/HE	M4	11
32FFD6-CA/HE	M6	22
63FFD6-HB/NH	M8	44
100FFD6-NC/PK	M10	70

T2 - Mounting Thread

Part No.	Thread	Torque max. in.lb.
10FFD6-CA/HE	M12 x 1	35
16FFD6-CA/HE	M12 x 1	35
32FFD6-CA/HE	M12 x 1	35
63FFD6-HB/NH	M20 x 1	89
100FFD6-NC/PK	M24 x 1	124
200FFD6-ND/RP	M27 x 1.5	142

Case Dimensions

Part No.	A <i>±.04</i> 1	B <i>±.02</i> 0.5	C <i>±.08</i> 2	D <i>±.04</i> 1	E <i>±.08</i> 2	F (max)
10FFD6-CA	3.54 90	0.79 20	1.93 49	0.47 12	0.63 16	0.67 17
16FFD6-CA	3.86	0.79	2.09	0.47	0.71	0.67
32FFD6-CA	98	20	53	12	18	17
63FFD6-HB	6.30 160	0.98 25	3.70 94	0.55 14	1.02 26	0.87 22
100FFD6-NC	7.24 184	1.26 32	4.09 104	0.63 16	1.26 32	1.06 27
200FFD6-ND	8.23 209	1.50 38	4.41 112	0.75 19	1.57 40	1.06 27
10FFD6-HE	5.12 130	0.79 20	3.50 89	0.47 12	0.63 16	0.67 17
16FFD6-HE	5.47	0.79	3.70	0.47	0.71	0.67
32FFD6-HE	139	20	94	12	18	17
63FFD6-NH	6.81 173	1.26 32	4.13 105	0.63 16	1.02 26	1.06 27
100FFD6-PK	8.98 173	1.50 32	5.71 105	0.75 16	1.26 26	1.06 27
200FFD6-RP	10.98 279	2.13 54	7.17 182	0.75 19	1.57 40	1.57 40

DC Feedthrough Filters - Class Y4 *(continued)*

FFD Series

Available Part Numbers

Standard Performance	High Performance
10FFD6-CA	10FFD6-HE
16FFD6-CA	16FFD6-HE
32FFD6-CA	32FFD6-HE
63FFD6-HB	63FFD6-NH
100FFD6-NC	100FFD6-PK
200FFD6-ND	200FFD6-RP

Performance Data

Typical Insertion Loss – Line to Ground in 50 Ohm circuit

Filter ID	Frequency – MHz							
	0.01	0.03	0.1	0.3	1	10	100	1000
CA	-	-	2	4	10	23	65	100
HB	2	4	10	18	27	62	95	100
HE	2	4	10	18	27	67	95	100
NC	7	14	23	30	32	70	100	100
ND	7	14	23	30	32	70	100	100
NH	7	14	23	31	35	75	100	100
PK	14	21	30	34	53	75	100	100
RP	20	32	40	52	85	100	100	100

AC Feedthrough Capacitors - Class Y2

AFC Series



Component Recognized by
UL to US and Canadian Requirements



AFC Series

- AC feedthrough capacitors
- Current ratings from 10 to 300A
- Designed to meet the very stringent safety requirements of EN132400 class Y2 including the 5000V pulse test
- Custom versions available

Ordering Information



Filter Options / Specifications

Filter ID	Value (nF)	Max. Leakage Current (mA)*
A	2.2	0.21
B	4.7	0.44
C	10	0.94
F	33	3.1
G	47	4.4
H	100	9.4
K	220	21
N	470	44
P	1000	94

*@250VAC 60 Hz

Specifications

Rated Voltage (max):	250 VAC
Operating Frequency:	50/60 Hz
Rated Current:	10 to 300A
Test Voltage (two seconds):	5000 VDC
Capacitor Class (EN132400):	Designed to meet Y2
Pulse Test (EN132400):	5000V Peak
Insulation Resistance (within 1 minute):	
	For C < 0.33µF, R > 15000MΩ
	For C > 0.33µF, RC(MΩ*µF) > 5000s
Operating Ambient Temperature Range (at rated current I _r):	
	10 to 200A: -40°C to +60°C
	250 & 300A: -40°C to +40°C
Category Temperature Range:	-40°C to +85°C
Current Derating Above Ambient:	
	10-200A: For temperature, θ $I_{\theta} = IR \sqrt{(85-\theta)/25}$
	250 & 300A: For temp., θ $I_{\theta} = IR \sqrt{(85-\theta)/45}$
Climatic Category:	40/85/21
MTBF:	> 10 million hours typical
Insulating Materials Flammability Rating:	UL94V-0
Case & Terminal Material:	Nickel Plated Brass

AC Feedthrough Capacitors - Class Y2 *(continued)*

AFC Series

Case Style

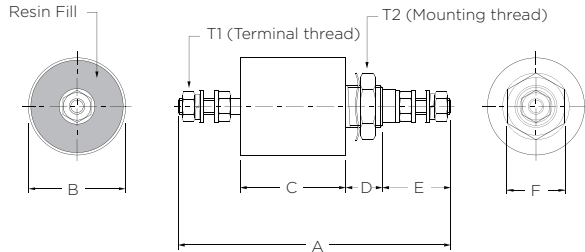

T1 - Terminal Thread

Part No.	Thread	Torque max. in.lb.
10AFC6-A/B	M3	4
16AFC6-B/C/G/H	M4	11
20AFC6-B		
32AFC6-B/C/F/G/H		
63AFC6-C/G/H	M6	22
100AFC6-G/H/K/N	M8	44
200AFC6-H/K/N/P	M10	71
250AFC6-H/K/N/P	M12	97
300AFC6-H/K/N/P	M16	177

T2 - Mounting Thread

Part No.	Thread	Torque max. in.lb.
10AFC6-A/B	M10 x 1	27
16AFC6-B/C/G	M12 x 1	35
20AFC6-B		
32AFC6-B/C/G/F		
16AFC6-H	M16 x 1	62
32AFC6-H		
63AFC6-C/G/H		
100AFC6-G/H	M20 x 1	89
100AFC6-K/N	M24 x 1	124
200AFC6-H/K		
200AFC6-N/P	M27 x 1.5	142

Case Dimensions

Part No.	A	B	C	D	E	F
	$\frac{\pm .04}{1}$	$\frac{\pm .02}{0.5}$	$\frac{\pm .08}{2}$	$\frac{\pm .04}{1}$	$\frac{\pm .08}{2}$	(max)
10AFC6-A	2.24	0.59	0.71	0.39	0.63	0.51
10AFC6-B	57	15	18	10	16	13
16AFC6-B	2.48	0.79	0.71	0.47	0.71	0.67
16AFC6-C	63	20	18	12	18	17
16AFC6-G	2.95	0.79	1.18	0.47	0.71	0.67
	75	20	30	12	18	17
16AFC6-H	3.03	0.98	1.18	0.55	0.71	0.87
	77	25	30	14	18	22
20AFC6-B	2.48	0.79	0.71	0.47	0.71	0.67
	63	20	18	12	18	17
32AFC6-B	2.48	0.79	0.71	0.47	0.71	0.67
32AFC6-C	63	20	18	12	18	17
32AFC6-F	2.95	0.79	1.18	0.47	0.71	0.67
32AFC6-G	75	20	30	12	18	17
32AFC6-H	3.03	0.98	1.18	0.55	0.71	0.87
	77	25	30	14	18	22
63AFC6-C	3.78	0.98	1.18	0.55	1.02	0.87
63AFC6-G	96	25	30	14	26	22
63AFC6-H	3.78	0.98	1.18	0.55	1.02	0.87
	96	25	30	14	26	22
100AFC6-G	4.45	1.26	1.30	0.63	1.26	1.06
100AFC6-H	113	32	33	16	32	27
100AFC6-K	4.57	1.50	1.30	0.75	1.26	1.06
	116	38	33	19	32	27
200AFC6-H	5.24	1.50	1.97	0.75	1.26	1.06
200AFC6-K	133	38	50	19	32	27
200AFC6-N	5.12	1.50	1.30	0.75	1.57	1.06
200AFC6-P	130	38	33	19	40	27
250AFC6-H	5.79	2.13	1.97	0.75	1.57	1.57
250AFC6-K	147	54	50	19	40	40
250AFC6-N	5.83	2.13	1.65	0.75	1.81	1.57
250AFC6-P	148	54	42	19	46	40
300AFC6-H	6.30	2.13	2.13	0.75	1.81	1.57
300AFC6-K	160	54	54	19	46	40
300AFC6-N	5.83	2.13	1.65	0.75	1.81	1.57
300AFC6-P	148	54	42	19	46	40

Dimensions are in inches and millimeters unless otherwise specified. Values in italics are metric equivalents. Dimensions are shown for reference purposes only. Specifications subject to change.

For email, phone or live chat, please go to te.com/help or corcom.com

AC Feedthrough Capacitors - Class Y2 *(continued)*

AFC Series

Available Part Numbers

10AFC6-A	32AFC6-H	200AFC6-P
10AFC6-B	63AFC6-C	250AFC6-H
16AFC6-B	63AFC6-G	250AFC6-K
16AFC6-C	63AFC6-H	250AFC6-N
16AFC6-G	100AFC6-H	250AFC6-P
16AFC6-H	100AFC6-H	300AFC6-H
20AFC6-B	100AFC6-K	300AFC6-K
32AFC6-B	100AFC6-N	300AFC6-N
32AFC6-C	200AFC6-H	300AFC6-P
32AFC6-F	200AFC6-K	
32AFC6-G	200AFC6-N	

Performance Data

Typical Insertion Loss – Line to Ground in 50 Ohm circuit

Filter ID	Frequency – MHz							
	0.01	0.03	0.1	0.3	1	10	100	1000
A	-	-	-	-	-	8	38	45
B	-	-	-	-	-	14	43	60
C	-	-	-	-	3	21	45	70
F	-	-	-	4	12	30	48	90
G	-	-	2	6	15	34	50	90
H	-	2	5	11	20	40	65	90
K	-	4	11	18	27	45	85	90
N	6	9	16	22	33	33	90	90
P	10	15	22	30	40	42	90	90

DC Feedthrough Capacitors - Class Y4

DFC Series



Component Recognized by
UL to US and Canadian Requirements



DFC Series

- DC feedthrough capacitors
- Current ratings from 10 to 300A
- Designed to meet the very stringent safety requirements of EN132400 class Y4 including the 2500V pulse test
- Custom versions available

Ordering Information



Filter Options / Specifications

Filter ID	Value (nF)
C	10
G	47
H	100
N	470
P	1000
Q	3300
R	4700
T	8000

Specifications

- Rated Voltage (max):** 130 VDC
- Rated Current:** 10 to 300A
- Test Voltage (two seconds):** 2500 VDC
- Capacitor Class (EN132400):** Designed to meet Y4
- Pulse Test (EN132400):** 2500V Peak
- Insulation Resistance (within 1 minute):**
 For C < 0.33µF, R > 15000MΩ
 For C > 0.33µF, RC(MΩ*µF) > 5000s
- Operating Ambient Temperature Range (at rated current I_r):**
 10 to 200A: -40°C to +60°C
 250 & 300A: -40°C to +40°C
- Category Temperature Range:** -40°C to +85°C
- Current Derating Above Ambient:**
 10-200A: For temperature, θ $I_{\theta} = IR \sqrt{(85-\theta)/25}$
 250 & 300A: For temp., θ $I_{\theta} = IR \sqrt{(85-\theta)/45}$
- Climatic Category:** 40/85/21
- MTBF:** > 10 million hours typical
- Insulating Materials Flammability Rating:** UL94V-0
- Case & Terminal Material:** Nickel Plated Brass

DC Feedthrough Capacitors - Class Y4 *(continued)*

DFC Series

Case Style



T1 - Terminal Thread

Part No.	Thread	Torque max. in.lb.
10DFC6-C	M3	4
16DFC6-C/G/H/N	M4	11
32DFC6-C/G/H/N	M4	11
63DFC6-C/G/H/N	M6	22
100FDC6-G/H/N/P	M8	44
200DFC6-H/N/P/R	M10	71
250DFC6-P/Q/T	M12	97
300DFC6-P/Q/T	M16	177

T2 - Mounting Thread

Part No.	Thread	Torque max. in.lb.
10DFC6-C	M10 x 1	27
16DFC6-C/G/H	M12 x 1	35
32DFC6-C/G/H	M12 x 1	35
63DFC6-C/G/H	M16 x 1	62
16DFC6-N	M20 x 1	89
32DFC6-N	M20 x 1	89
63DFC6-N	M20 x 1	89
100DFC6-G/H/N	M24 x 1	124
100DFC6-P	M24 x 1	124
200DFC6-H/N/P	M24 x 1	124
200FFC6-R	M27 x 1.5	142

Case Dimensions

Part No.	A	B	C	D	E	F
	$\frac{\pm.04}{1}$	$\frac{\pm.02}{0.5}$	$\frac{\pm.08}{2}$	$\frac{\pm.04}{1}$	$\frac{\pm.08}{2}$	(max)
10DFC6-C	2.24 57	0.59 15	0.71 18	0.39 10	0.63 16	0.51 13
16DFC6-C	2.48 63	0.79 20	0.71 18	0.47 12	0.71 18	0.67 17
16DFC6-G	2.95	0.79	1.18	0.47	0.71	0.67
16DFC6-H	75	20	30	12	18	17
16DFC6-N	3.23 82	1.26 32	1.30 33	0.63 16	0.71 18	1.06 27
32DFC6-C	2.48 63	0.79 20	0.71 18	0.47 12	0.71 18	0.67 17
32DFC6-G	2.95	0.79	1.18	0.47	0.71	0.67
32DFC6-H	75	20	30	12	18	17
32DFC6-N	3.23 82	1.26 32	1.30 33	0.63 16	0.71 18	1.06 27
63DFC6-C	3.78	0.98	1.18	0.55	1.02	0.87
63DFC6-G	96	25	30	14	26	22
63DFC6-H	3.98	1.26	1.30	0.63	1.02	1.06
63DFC6-N	101	32	33	16	26	27
100DFC6-G	4.45	1.26	1.30	0.63	1.26	1.06
100DFC6-H	113	32	33	16	32	27
100DFC6-N	5.24 133	1.50 38	1.97 50	0.75 19	1.26 32	1.06 27
200DFC6-H	5.12	1.26	1.30	0.75	1.57	1.06
200DFC6-N	130	32	33	19	40	27
200DFC6-P	5.79 147	1.50 38	1.97 50	0.75 19	1.57 40	1.06 27
200DFC6-R	6.50 165	2.13 54	2.68 68	0.75 19	1.57 40	1.57 40
250DFC6-P	5.83	2.13	1.65	0.75	1.81	1.57
300DFC6-P	148	54	42	19	46	40
250DFC6-Q	6.30	2.13	2.13	0.75	1.81	1.57
300DFC6-Q	160	54	54	19	46	40
250DFC6-T	7.01	2.13	2.83	0.75	1.81	1.57
300DFC6-T	178	54	72	19	46	40

DC Feedthrough Capacitors - Class Y4 *(continued)*

DFC Series

Available Part Numbers

10DFC6-C	32DFC6-H	100DFC6-H	250DFC6-P
16DFC6-C	32DFC6-N	100DFC6-N	250DFC6-Q
16DFC6-G	63DFC6-C	100DFC6-P	250DFC6-T
16DFC6-H	63DFC6-G	200DFC6-H	300DFC6-P
16DFC6-N	63DFC6-H	200DFC6-N	300DFC6-Q
32DFC6-C	63DFC6-N	200DFC6-P	300DFC6-T
32DFC6-G	100DFC6-G	200DFC6-R	

Performance Data

Typical Insertion Loss – Line to Ground in 50 Ohm circuit

Filter ID	Frequency – MHz							
	0.01	0.03	0.1	0.3	1	10	100	1000
C	-	-	-	-	3	21	45	70
G	-	-	2	6	15	34	50	90
H	-	2	5	11	20	40	65	90
N	6	9	15	22	33	33	90	90
P	10	15	24	32	42	50	90	90
Q	13	21	31	42	50	58	90	90
R	18	26	36	45	42	70	90	90
T	22	31	41	52	62	82	90	90

Engineering Notes



6. Signal Line Products – Table of Contents

Introduction	242
SignalSentry Filtered Modular Jacks	243
SignalSentry Product Part Number Matrix / Ordering Information ...	244
SignalSentry Product Selector Chart	245
L Series	247
L - Ganged Series	248
LC Series	249
LCT Series	250
N Series	251
X Series	252
Z Series	253
Model Dimensions	255
L, LC, LCT and X Series RJ Jack Dimensions	255
N and Z Series RJ Jack Dimensions	257

Introduction

Corcom brand SignalSentry filtered modular jack series product combines different levels of filtering with RJ45 and RJ11 modular jacks to solve signal line noise problems and crosstalk.



Corcom brand SignalSentry filtered modular jack series product has expanded into 80 different products for filtering the signal line, including inductor and capacitor, shielded, ganged, low profile and surface mountable versions. Designs not only save valuable panel space, but also place the filtering elements where they can be most effective in eliminating RFI.

The L and N series RJ11 and RJ45 jacks offer filtering with inductance and optional shielding, while the LC and LCT series combine inductance with 82pF or 820pF capacitors. The X and Z series complete the offering with unfiltered versions of our standard profile and low profile jacks.

Use the selector chart to combine your filtering performance with the RJ11 or RJ45 jacks. Mechanical dimensions are listed following the series information.

For the latest information and additional technical articles, find Corcom products on the Internet at www.corcom.com.

SignalSentry Filtered Modular Jacks

Corcom brand SignalSentry filtered modular jacks are a space saving and cost-effective solution to RFI problems on signal lines. Its inductive and optional capacitive elements effectively strip common-mode noise from the incoming signal, and at the same time limit the signal line's ability to radiate emissions like an antenna.

The SignalSentry filtered modular jack series has expanded into 80 different products for filtering the signal line, including inductor and capacitor, shielded, ganged, low profile and surface mountable versions. Filtered RJ jacks provide interference suppression at the optimal location by integrating the filtering into the RJ jack itself. Our new ganged jacks are the only RJ11 filtered ganged jacks available in the market.

SignalSentry filtered modular jack products are useful for any electronic equipment that sends or receives data on unshielded twisted pair or other multi-conductor cabling systems. Modems, PBX's, LAN, ISDN, and local I/O interfaces that use RJ connectors are all candidates. Jack design and component selection compatible with equipment registered under FCC part 68.

 UL Recognized

 CSA Certified

Applications

A fax/modem board was being certified for FCC Class B emissions at an independent test laboratory. The board caused every computer it was tested in to exceed the radiated limits above 30 MHz, at multiples of each microprocessor's clock frequency, on the telephone line.



The test lab replaced the modem's unfiltered RJ11 jack with a **Corcom RJ11-4L-B** filtered modular jack out of their sample kit, and the board/computer combinations passed with 4 dB margin worst case.



A RISC workstation designed to operate in a twisted-pair Local Area Network required two DIP package inductors and 12 chip capacitors to meet



FCC radiated emissions limits. All 14 discrete components were eliminated by replacing the two RJ45 connectors with two **Corcom RJ45-8LC1-B** shielded and filtered jacks, and the margin of compliance actually improved.



A secure telephone set failed hardened application testing at a government facility, due to intelligible emanations radiated from the coiled handset cord. The unit passed after the handset connector in the desk set was replaced by a **Corcom RJH-4L-B** filtered handset jack.



A medical manufacturer was designing a heart monitor which would transfer data over a signal line to the nurses' station so they could monitor patients. When the doctors used their modems, the data coming from the monitor became distorted.

This occurred due to the close proximity of the modem card and monitor communication card placed next to each other. A **Corcom low profile RJ45-8N3-B** modular jack was designed in to filter out the unwanted noise.

SignalSentry Part Number Matrix / Ordering Information

WHAT TYPE OF CONNECTOR DO YOU NEED?

Handset jack four pin connector
RJ11 six pin connector
RJ45 eight pin connector

RJH
RJ11
RJ45

RJ11-4L1-B

HOW MANY TERMINALS WILL BE LOADED? (See below)

4 on RJH
2, 4 or 6 on RJ11
6 or 8 on RJ45

RJ11-4L1-B

WHAT LEVEL OF FILTERING PERFORMANCE DO YOU NEED?

No filter, standard profile
Inductor (block or sleeve), standard profile
Inductor plus capacitors with shield
Inductor, 82 pF cap. and shield
Inductor (block or sleeve), low profile
No filter, low profile

X models
L models
LC models
LCT model
N models
Z models

RJ11-4L1-B

DO YOU WANT A SHIELDED JACK? (Optional on L, X, N, Z models, required on LC or LCT.)

WHAT TYPE OF GROUND?

¹Panel and board ground (spring fingers on panel interface)
¹Board ground pins only
²Panel, board and cable ground (low profile versions)
²Board ground and cable ground (low profile versions)

1
2
3
4

RJ11-4L1-B

¹L, LC, LCT, X models
²N, Z models

WHAT TYPE OF INDUCTORS DO YOU NEED?

Sleeve — Average performance
Block — Higher performance

S
B

RJ11-4L1-B

Sleeve inductance is recommended in cases where crosstalk may be a problem.

RJ11 Model Contact Loading Program



RJ45 Model Contact Loading Program



Jack Designation	Lead Frame Position					
	1	2	3	4	5	6
RJ11 - 2			X	X		
RJ11 - 4		X	X	X	X	
RJ11 - 6	X	X	X	X	X	X

Jack Designation	Lead Frame Position							
	1	2	3	4	5	6	7	8
RJ45 - 6		X	X	X	X	X	X	
RJ45 - 8	X	X	X	X	X	X	X	X

SignalSentry Selector Chart



Engineering Notes



Inductive Filtering Modular RJ Jacks

L Series



UL Recognized
CSA Certified

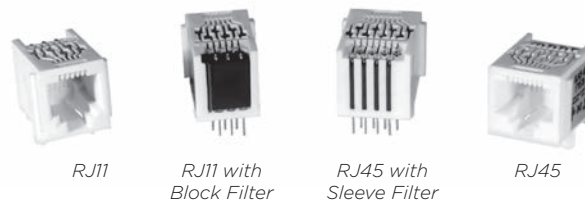

L Series

- Inductive filtering in standard RJ11, RJ45, or handset jacks.
- Available with standard ferrite sleeve inductors or higher performance ferrite blocks
- Available unshielded or shielded with board grounded shield or spring fingered panel ground interface

Available Part Numbers

Inductor Filter	
RJH-4L-B	RJ45-6L-S
RJ11-2L-S	RJ45-6L-B
RJ11-2L-B	RJ45-8L-S
RJ11-4L-S	RJ45-8L-B
RJ11-4L-B	
RJ11-6L-S	
RJ11-6L-B	

Inductor Filter and Shield	
RJ11-2L2-B	RJ45-6L1-S
RJ11-4L1-S	RJ45-6L1-B
RJ11-4L1-B	RJ45-6L2-S
RJ11-4L2-S	RJ45-6L2-B
RJ11-4L2-B	RJ45-8L1-S
RJ11-6L1-S	RJ45-8L1-B
RJ11-6L1-B	RJ45-8L2-S
RJ11-6L2-S	RJ45-8L2-B
RJ11-6L2-B	



Specifications

- Contacts:**
 Material: Phosphor Bronze
 Plating: 50 microinches gold
 Barrier underplating: 100 microinches nickel
 Resistance:
 Initial: 20 mΩ max.
 After 500 mating cycles: 30 mΩ max.
- Ferrites:**
 Type: High resistivity, nickel zinc ceramic
 Sleeves: Single-aperture cylinders
 Block: Multi-aperture rectangular prism
- Shield Material:** Tin-plated copper alloy
- Housing Material:** Glass-filled polyester (UL94V-0)
- Dielectric Withstanding Voltage:**
 Line to Line and Line to Ground: 1000 VAC for 60 seconds
- Printed Circuit Board Retention:**
 Before soldering: 1 lb. minimum
 After soldering: 20 lb. minimum

Typical Impedance in Ohms



Model dimensions and PC board layout on pages 255-259

Inductive Filtering Ganged Modular RJ Jacks

L - Ganged Series



UL Recognized
CSA Certified



L - Ganged Series

- Ganged version of our L Series filtered jacks
- Available in RJ11 models with block inductors
- Available in gangs of 2, 4 or 6
- Retrofits existing unfiltered ganged jack footprints

Dimensions and PC Board Layout



Ports	A	B	C	D
2	0.99	0.87	0.795	.87
	25.15	22.1	20.19	22.1
4	1.93	1.81	1.735	1.81
	49.02	45.97	44.07	25.97
6	2.87	2.75	2.675	2.75
	72.9	69.85	67.95	69.85

Specifications

Contacts:
 Material: Phosphor Bronze
 Plating: 50 microinches gold
 Barrier underplating: 100 microinches nickel
 Resistance:
 Initial: 20 mΩ max.
 After 500 mating cycles: 30 mΩ max.

Ferrites:
 Type: High resistivity, nickel zinc ceramic
 Block: Multi-aperture rectangular prism

Housing Material: Glass-filled polyester (UL94V-0)

Dielectric Withstanding Voltage:
 Line to Line and Line to Ground: 1000 VAC for 60 seconds

Printed Circuit Board Retention:
 Before soldering: 1 lb. minimum
 After soldering: 20 lb. minimum

Available Part Numbers

2RJ11-6L-B	4RJ11-6L-B
6RJ11-6L-B	

Typical Impedance in Ohms



Filtered Modular Jacks with Enhanced Performance

LC Series



UL Recognized
CSA Certified



LC Series

- Chip capacitors provide enhanced filtering performance on each line
- Available with block or sleeve inductance
- Available with board grounded shield or spring fingered panel ground interface

Performance Data

Typical Insertion Loss

Line to ground (stop band) in 50 Ohm circuit

Model	Frequency – MHz						
	30	60	80	100	200	500	1000
S – Ferrite Sleeves	28	40	51	40	27	24	22
B – Ferrite Blocks	30	41	59	40	31	28	24

Line to line (pass band) in 50 Ohm circuit

Model	Frequency – MHz						
	2	5	10	30	50	70	100
S – Ferrite Sleeves	-	4	8	18	24	30	40
B – Ferrite Blocks	1	8	11	21	28	33	37

Model dimensions and PC board layout on pages 255-259

Specifications

Contacts:
 Material: Phosphor Bronze
 Plating: 50 microinches gold
 Barrier underplating: 100 microinches nickel
 Resistance:
 Initial: 20 mΩ max.
 After 500 mating cycles: 30 mΩ max.

Capacitors:
 Type: Monolithic ceramic chip
 Standard Value: 820 pF
 Standard Tolerance: ± 20%

Ferrites:
 Type: High resistivity, nickel zinc ceramic
 Sleeves: Single-aperture cylinders
 Block: Multi-aperture rectangular prism

Shield Material: Tin-plated copper alloy

Housing Material: Glass-filled polyester (UL94V-0)

Dielectric Withstanding Voltage:
 Line to Line and Line to Ground: 1000 VAC for 60 seconds

Printed Circuit Board Retention:
 Before soldering: 1 lb. minimum
 After soldering: 20 lb. minimum

Available Part Numbers

RJ11-2LC1-S	RJ11-6LC2-S
RJ11-2LC1-B	RJ11-6LC2-B
RJ11-2LC2-S	RJ45-6LC1-S
RJ11-2LC2-B	RJ45-6LC1-B
RJ11-4LC1-S	RJ45-6LC2-S
RJ11-4LC1-B	RJ45-6LC2-B
RJ11-4LC2-S	RJ45-8LC1-S
RJ11-4LC2-B	RJ45-8LC1-B
RJ11-6LC1-S	RJ45-8LC2-S
RJ11-6LC1-B	RJ45-8LC2-B

Low Capacitance Modular RJ Jacks

LCT Series



UL Recognized
CSA Certified



LCT Series

- Low capacitance model for improved performance.
- Particularly suited for ethernet applications
- Available with block or sleeve inductance
- Available with board grounded shield or spring fingered panel ground interface

Performance Data

Typical Insertion Loss

Line to ground (stop band) in 50 Ohm circuit

Model	Frequency – MHz						
	40	100	200	250	300	500	1000
S – Ferrite Sleeves	8	12	27	50	38	25	20
B – Ferrite Blocks	10	18	22	55	40	28	24

Line to line (pass band) in 50 Ohm circuit

Model	Frequency – MHz						
	2	5	10	30	50	70	100
S – Ferrite Sleeves	-	1.2	1.9	4	5	7	10
B – Ferrite Blocks	1	2	3	5	8	10	13

Model dimensions and PC board layout on pages 255-259

Specifications

Contacts:
 Material: Phosphor Bronze
 Plating: 50 microinches gold
 Barrier underplating: 100 microinches nickel
 Resistance:
 Initial: 20 mΩ max.
 After 500 mating cycles: 30 mΩ max.

Capacitors:
 Type: Monolithic ceramic chip
 Standard Value: 82 pF
 Standard Tolerance: ± 20%

Ferrites:
 Type: High resistivity, nickel zinc ceramic
 Sleeves: Single-aperture cylinders
 Block: Multi-aperture rectangular prism

Shield Material: Tin-plated copper alloy

Housing Material: Glass-filled polyester (UL94V-0)

Dielectric Withstanding Voltage:
 Line to Line and Line to Ground: 1000 VAC for 60 seconds

Printed Circuit Board Retention:
 Before soldering: 1 lb. minimum
 After soldering: 20 lb. minimum

Available Part Numbers

RJ11-6LCT1-S	RJ45-8LCT1-S
RJ11-6LCT1-B	RJ45-8LCT1-B
RJ11-6LCT2-S	RJ45-8LCT2-S
RJ11-6LCT2-B	RJ45-8LCT2-B

Low Profile Filtered Modular Jacks

N Series



UL Recognized
CSA Certified



Shield 3
RJ11



Shield 4
RJ45

N Series

- Low profile SignalSentry filtered jack
- Available with sleeve or block inductors
- Available unshielded or shielded with board grounded shield or spring fingered panel ground interface

Typical Impedance in Ohms



Unshielded
Ferrite Block

Specifications

Contacts:
 Material: Phosphor Bronze
 Plating: 50 microinches gold
 Barrier underplating: 100 microinches nickel
 Resistance:
 Initial: 20 mΩ max.
 After 500 mating cycles: 30 mΩ max.

Ferrites:
 Type: High resistivity, nickel zinc ceramic
 Sleeves: Single-aperture cylinders
 Block: Multi-aperture rectangular prism

Shield Material: Tin-plated copper alloy

Housing Material: Black glass-filled polyamide (STANYL TE250F3)

Dielectric Withstanding Voltage:
 Line to Line and Line to Ground: 1000 VAC for 60 seconds

Printed Circuit Board Retention:
 Before soldering: 1 lb. minimum
 After soldering: 20 lb. minimum

Available Part Numbers

RJ11-6N-B	RJ45-8N-B
	RJ45-8N-S
RJ11-6N3-B	RJ45-8N3-B
	RJ45-8N3-S
RJ11-6N4-B	RJ45-8N4-B
	RJ45-8N4-S

Model dimensions and PC board layout on pages 255-259

Unfiltered Modular Jacks

X Series



UL Recognized
CSA Certified



RJ45



RJ11

X Series

- Unfiltered standard jack
- RJ11 or RJ45
- 2, 4, 6 or 8 loaded contacts
- Available unshielded or shielded with board grounded shield or spring fingered panel ground interface



Shield 1



Shield 2

Specifications

Contacts:	
Material:	Phosphor Bronze
Plating:	50 microinches gold
Barrier underplating:	100 microinches nickel
Resistance:	
Initial:	20 mΩ max.
After 500 mating cycles:	30 mΩ max.
Shield Material:	Tin-plated copper alloy
Housing Material:	Glass-filled polyester (UL94V-0)
Dielectric Withstanding Voltage:	
Line to Line and Line to Ground:	1000 VAC for 60 seconds
Printed Circuit Board Retention:	
Before soldering:	1 lb. minimum
After soldering:	20 lb. minimum

Available Part Numbers

RJ11-2X	RJ45-6X
RJ11-4X	RJ45-8X
RJ11-6X	RJ45-8X1
	RJ45-8X2

Model dimensions and PC board layout on pages 255-259

Low Profile Unfiltered Modular Jacks

Z Series



UL Recognized
CSA Certified



Shield 3
RJ11

Shield 4
RJ45

Z Series

- Low profile
- Unfiltered
- Available unshielded or shielded with board grounded shield or spring fingered panel ground interface

Available Part Numbers

RJ11-6Z	RJ45-8Z
RJ11-6Z3	RJ45-8Z3
RJ11-6Z4	RJ45-8Z4

Specifications

Contacts:	
Material:	Phosphor Bronze
Plating:	50 microinches gold
Barrier underplating:	100 microinches nickel
Resistance:	
Initial:	20 mΩ max.
After 500 mating cycles:	30 mΩ max.
Shield Material:	Tin-plated copper alloy
Housing Material:	Black glass-filled polyester (VALOX 457)
Dielectric Withstanding Voltage:	
Line to Line and Line to Ground:	1000 VAC for 60 seconds
Printed Circuit Board Retention:	
Before soldering:	1 lb. minimum
After soldering:	20 lb. minimum

Model dimensions and PC board layout on pages 255-259

Engineering Notes

A large, empty grid area for writing engineering notes, consisting of a uniform pattern of small squares.

Model Dimensions

L, LC, LCT and X Series RJ Jack Dimensions

RJ11 - No Shield



Part No.		
RJ11-2L-S	RJ11-2L-B	RJ11-2X
RJ11-4L-S	RJ11-4L-B	RJ11-4X
RJ11-6L-S	RJ11-6L-B	RJ11-6X

RJ11 - Style 2 Shield



Part No.			
RJ11-2LC2-S	RJ11-2LC2-B	RJ11-4L2-S	RJ11-6L2-B
RJ11-4LC2-S	RJ11-4LC2-B	RJ11-6L2-S	RJ11-6LCT2-S
RJ11-6LC2-S	RJ11-6LC2-B	RJ11-4L2-B	RJ11-6LCT2-B

RJ11 - Style 1 Shield



Part No.			
RJ11-2LC1-S	RJ11-2LC1-B	RJ11-4L1-S	RJ11-6L1-B
RJ11-4LC1-S	RJ11-4LC1-B	RJ11-6L1-S	RJ11-6LCT1-S
RJ11-6LC1-S	RJ11-6LC1-B	RJ11-4L1-B	RJ11-6LCT1-B

RJ11 - PC Board Layout



For all RJ11 L, LC, LCT and X Series Models
Shown from Component Side

All tolerances ± 0.010 [0.25] unless otherwise noted

Model Dimensions (continued)

L, LC, LCT and X Series RJ Jack Dimensions (continued)

RJ45 - No Shield



Part No.

RJ45-6L-S	RJ45-8L-B
RJ45-8L-S	RJ45-6X
RJ45-6L-B	RJ45-8X

RJ45 - Style 2 Shield



Part No.

RJ45-6LC2-S	RJ45-8LC2-S	RJ45-6LC2-B	RJ45-8LC2-B
RJ45-6L2-S	RJ45-8L2-S	RJ45-6L2-B	RJ45-8L2-B
RJ45-8LCT2-S	RJ45-8LCT2-B		

RJ45 - Style 1 Shield



Part No.

RJ45-6LC1-S	RJ45-8LC1-S	RJ45-6LC1-B
RJ45-6L1-S	RJ45-8L1-S	RJ45-6L1-B
RJ45-8LCT1-S	RJ45-8LCT1-B	RJ45-8L1-B

RJ45 - PC Board Layout



For all RJ45 L, LC, LCT and X Series Models
Shown from Component Side

All tolerances ± 0.010 [0.25] unless otherwise noted

Model Dimensions (continued)

L, LC, LCT and X Series RJ Jack Dimensions (continued)

RJH - No Shield



RJH - PC Board Layout



N and Z Series RJ Jack Dimensions

RJ11 - Low Profile, No Shield



RJ11 Low Profile, Style 3 Shield



All tolerances ± 0.010 [0.25] unless otherwise noted

Model Dimensions (continued)

N and Z Series RJ Jack Dimensions (continued)

RJ11 Low Profile, Style 4 Shield



Part No.

RJ11-6N4-B

RJ11-6Z4

RJ45 - Low Profile, No Shield

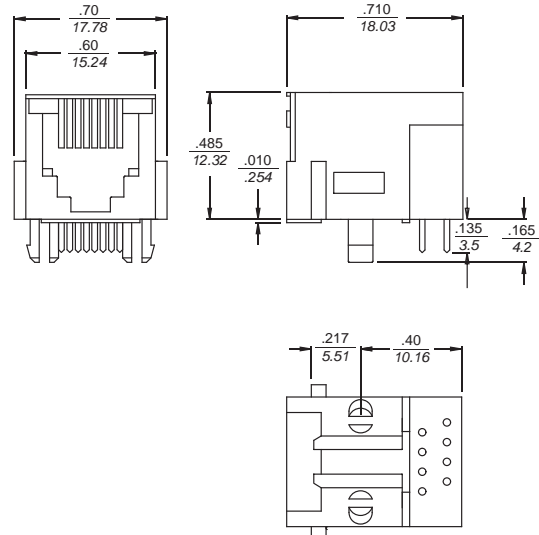

Part No.

RJ45-8N-B

RJ45-8N-S

RJ45-8Z

RJ11 Low Profile, PC Board Layout



For all RJ11 N and Z Series Models
Shown from Component Side

RJ45 - Low Profile, Style 3 Shield

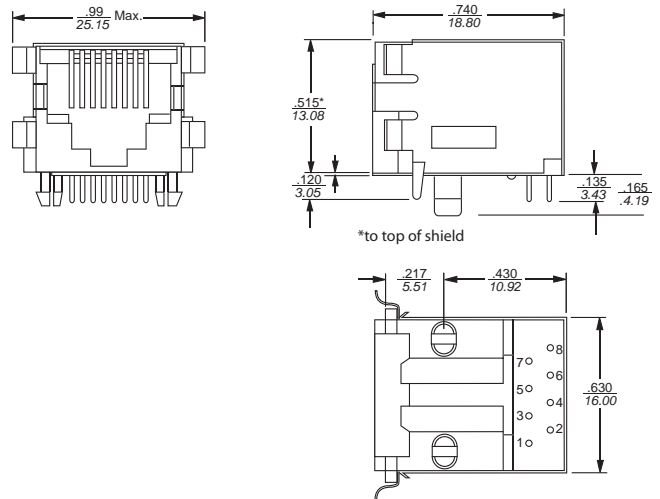

Part No.

RJ45-8N3-B

RJ45-8N3-S

RJ45-8Z3

All tolerances ± 0.010 [0.25] unless otherwise noted

Model Dimensions *(continued)*

N and Z Series RJ Jack Dimensions *(continued)*

RJ45 Low Profile, Style 4 Shield

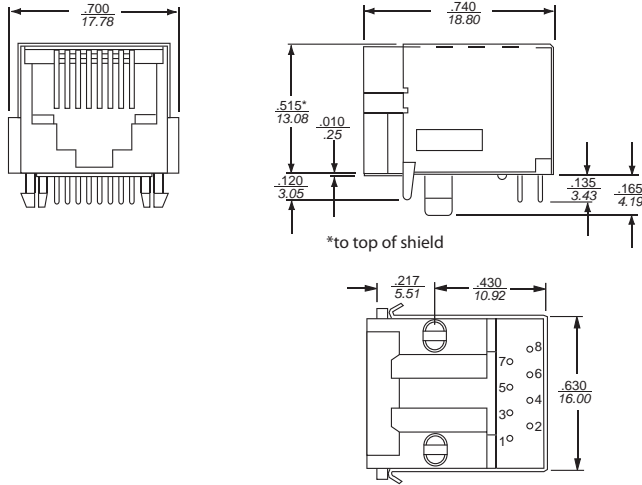

Part No.

RJ45-8N4-B	RJ45-8N4-S	RJ45-8Z4
------------	------------	----------

RJ45 Low Profile PC Board Layout



For all RJ45 N and Z Series Models
Shown from Component Side

All tolerances ± 0.010 [0.25] unless otherwise noted

Engineering Notes



7. Technical Notes — Table of Contents

Introduction	262
Understanding RFI Power Line Filters	263
Understanding Hipot Testing	266
Understanding Leakage Current (Touch Current)	267
Understanding Insertion Loss	268
Appendix A - Conducted RFI Emissions Testing	269
Appendix B - Conducted RFI Susceptibility Testing	270
Appendix C - Health Care Equipment	270
Appendix D - Safety Agency File Numbers	271

Introduction



TE Connectivity (TE) has established itself as a world leader in RFI technology by introducing the first line of catalog filter products over 50 years ago. Today, TE continues to pursue the latest in RFI filter design through testing and evaluating power supplies and studying their effects.

Changing international standards obligate designers to constantly review and evaluate their filtering needs. The following section provides some basic information on RFI terminology and filter selection.

Additional information can be accessed through TE's Corcom product internet pages at www.corcom.com

Understanding RFI Power Line Filters

What Is Radio Frequency Interference (RFI)?

RFI is unwanted electromagnetic energy in the frequency range generally used for radio communications. The frequency ranges of interest are 10kHz to 30MHz for conducted phenomena and 30MHz to 1GHz for radiated phenomena.

What are the modes of propagation of RFI?

RFI is propagated via radiation (electromagnetic waves in free space) and by conduction over signal lines and AC power systems.

Radiated - One of the most significant contributors to radiated RFI from electronic equipment is the AC power cord. The power cord is often an efficient antenna since its length approaches a quarter wave length for the RFI frequencies present in digital equipment and switching power supplies.

Conducted - RFI is conducted over the AC power system in two modes. Common mode (asymmetrical) RFI is present on both the line and neutral current paths with reference to the ground or earth path. Differential mode (symmetrical) RFI is present as a voltage between the line and neutral leads.

Why Be Concerned with RFI?

The designers and manufacturers of digital equipment must concern themselves with RFI for two reasons. (1) Their equipment must operate properly in the application environment, often in the presence of significant levels of RFI. (2) Their equipment must not emit RFI that interferes with RF communications often vital to health and safety. The necessity for reliable RF communications has given rise to legal regulations ensuring RFI control for electronic equipment.

What are the FCC requirements?

The U.S. Federal Communications Commission (FCC) has established regulations to reduce the interference potential of electronic computing devices (FCC Rules, Part 15, Subpart J). A computing device is defined as any electronic device or system that generates and uses timing signals or pulses at a rate in excess of 10,000 per second and that uses digital techniques. It is important to note that a switching power supply does not itself fall into this category, but that its emissions must still meet the limits when it is installed in a piece of equipment that is subject to the regulations.

The level of emissions the equipment must meet depends on whether it is marketed for use in a residential environment (Class B) or in a commercial, industrial, or business environment (Class A). The limits for Class B are more stringent than those for Class A (see Appendix A). Most Class B equipment must undergo certification, meaning that emissions

test data must be submitted to the FCC for type approval. Class A and all other Class B equipment must be verified—i.e. the manufacturer conducts his own emissions testing and verifies that he complies with the limits, but no forms need to be filed with the FCC.

Further details on FCC requirements can be obtained from the FCC, RF Devices Branch (Authorization and Standards Division), Washington, DC 20554, (301) 725-1585.

What are CE markings and RFI filters?

As of January 1, 1996, electrical and electronic equipment shipped to Europe is required to be labeled with the CE marking. In order to apply the CE marking, equipment must meet the General Product Safety Directive and Electromagnetic Compatibility Directive.

RFI power line filters are components and therefore not covered by the CE requirements, but they are used in electronic systems to meet EMC specifications.

Two of the most common emission specifications are EN 55011 for industrial, science, and medical equipment, and EN 55022 for information technology equipment. The conducted emission limits for these specifications are the same and broken down to Class "A" and Class "B" limits. Electronic equipment that may be connected to a power main shared with a residential area must comply with the more stringent Class "B" limits. The measurement technique is done using quasi-peak and average detection, with different limits for each measure in dB above one microvolt.

There are several immunity tests to which electronic equipment must comply, one of which is the electrically fast transient (EFT), IEC 61000-4-4. The equipment must continue to operate during this test. The transient wave form is a 5ns rise time with a 50ns duration. A burst is induced onto the power line at 1kV with a repetition rate of 5kHz lasting 15ms and repeated every 300ms. The test simulates switching of inductive loads and contacts.

To pass the EFT test, it is important that the RFI filter's enclosure have a good RF ground with the system's chassis ground. This provides a lower impedance path from the safety ground to the system ground. The shielding effect of the RFI filter's metal enclosure eliminates radiation into the system's cabinet induced by the conducted EFT burst. Stray capacitance may occur from any of the three input power wires to chassis ground where voltage can build up from the EFT burst and cause system interrupts. The RFI filter's inductor offers an impedance to the burst.

Understanding RFI Power Line Filters *(continued)*

In cases where the stray capacitances have caused multiple RF ground planes or where plastic enclosures are used, an inductive choke may be needed to provide isolation of the safety ground from the chassis ground.

What Is a Power Line Interference Filter?

A power line interference filter is a primary tool available to the designer of electronic equipment to control conducted RFI both into the equipment (potential equipment malfunction) and out of the equipment (potential interference to other system elements or RF communication). By controlling the RFI conducted onto the power cord, a power line filter also contributes significantly to the amount of radiated RFI.

A power line filter is a multiple-port network of passive components arranged as a dual low-pass filter; one network for common mode attenuation, another network for differential mode attenuation. The network provides attenuation of RF energy in the stopband of the filter (typically above 10kHz), while passing the power current (50-60Hz) with little or no attenuation.

How Does a Power Line Interference Filter Work?

Power line interference filters, as passive, bilateral networks, have complex transfer characteristics, which are extremely dependent upon source and load impedance. The magnitude of this transfer characteristic describes the attenuation performance of the filter. In the power line environment, however, the source and load impedances are not defined. Therefore the industry has standardized upon the practices of verifying filter uniformity through measurement of attenuation with 50 Ohm resistive source and load terminations. This measurement is defined to be the Insertion Loss (I.L.) of the filter.

$$I.L. = 10 \log \frac{P_L (Ref)}{P_L}$$

where $P_L (Ref)$ is the power transferred from the source to the load without the filter, and P_L is the power transferred when a filter is inserted between the source and load. The Insertion Loss may also be expressed in terms of voltage or current ratios as shown:

$$I.L. = 20 \log \frac{V_L (Ref)}{V_L}$$

$$I.L. = 20 \log \frac{I_L (Ref)}{I_L}$$

where $V_L (Ref)$ and I_L are measured without a filter and V_L and I_L are measured with a filter.

It is important to note that Insertion Loss does not describe the RFI attenuation provided by a filter in the power line environment. In the power line environment the relative magnitudes of the source and load impedances must be estimated and the appropriate filter configuration selected such that the greatest possible impedance mismatch occurs at each termination.

This dependence of filter performance on terminated impedances is the basis for the concept of "mismatching networks."

What is the concept of power line filters as "Impedance Mismatching Networks"?

RFI power line filters can be thought of as "impedance mismatching networks" at higher frequencies in the attenuation band. Network analysis shows that the greater the mismatch of filter impedance to terminating impedance, the more effective the filter is in attenuating RF energies.

Common mode power line impedance is considered to be low (on the order of 50 Ohms). Thus, following the concept of an impedance mismatch, Corcom power line filters employ a high common mode impedance (series inductance) on the power line side of the filter.

For load (equipment) side common mode impedance mismatch, Corcom products are available with a high impedance (series inductance) or a low impedance (shunt capacitance).

High (common mode) impedance filters for use with low impedance equipment include the EP, H, 6A Q, R and V series. Low (common mode) impedance filters for use with high impedance equipment include the B, EC, ED, EF, G, K, N, 3A Q, S, SK, T, W, X, Y, and Z series.

Knowing the input impedance of your equipment, then, may be useful in initially selecting the filter series most likely to solve your RFI problems. However, since this impedance is almost certainly complex (having both resistive and reactive components), it may vary widely over the RFI frequency range. Hence a variety of series should be evaluated in your quest for the most effective filter in any one application.

Do all filter networks with the same circuit and element values perform identically?

All filter networks with the same circuit and element values do not perform identically. Element values are specified and measured at a single frequency (usually 1kHz). Filter performance is required over the entire frequency spectrum, not just at the frequency of component measurement. The type of component construction and method of incorporation into a filter are extremely important to filter performance.

Understanding RFI Power Line Filters *(continued)*

Figure 1 illustrates the high-frequency performance difference between the three leaded capacitor construction employed by TE and a conventional method of construction. Both units would be specified by the same nominal 1kHz component value, approximately 5000pF.

Figure 1: Insertion Loss



How Do You Select a Power Line Interference Filter?

The only way to select and qualify a power line interference filter is to test the unit in your equipment. As mentioned above, the performance is highly dependent on equipment load impedance. Filter performance cannot be derived from single impedance (50 Ohm) insertion loss data. Performance is a complex function of filter element impedances and equipment impedances which vary in magnitude and phase over the frequency spectrum of interest. Filter selection testing should be performed in your equipment to your required level of performance for both conducted emission control (FCC, VDE) and susceptibility control.

How do you perform conducted emission tests?

Conducted emission testing requires a quiet RF environment—usually a shielded enclosure—a line impedance stabilization network, and an RF voltage instrument such as a tuned receiver or a spectrum analyzer. Additional testing information is given in Appendix A. The RF ambient of the test environment should be at least 20 dB below the desired compliance limit for accurate results. The line impedance stabilization network (LISN) is required to establish a desired source impedance for the power line input. This is an important part of the test procedure, since this impedance directly affects the measured emission levels. The correct bandwidth for the measurement receiver is also a critical test parameter.

How do you perform susceptibility testing?

Susceptibility testing involves injection of noise onto the power input lines while monitoring the equipment for proper operation. Quantification of the noise levels to be found in the equipment environment is difficult at best. Through analysis of solutions to specific susceptibility problems, TE has developed recommended noise injection levels, which proved a high level of confidence for reliable equipment operation in the real world environment. The test methods and injection noise levels are found in Appendix B.

Is installation important to filter performance?

Mounting and wiring of the filter are critical influences on its performances. A power line filter is best installed at the power line input point of your equipment. The filter is a barrier to high frequency signals. Its purpose must not be defeated by stray capacitance coupling the power input leads to the power output leads, or to any other conductors in the protected equipment.

Normally the case of the filter is bolted to the framework or chassis of the electronic equipment it protects. The line side leads should be kept short and well separated from the load side leads. The ideal isolation system is a bulkhead-mounted filter incorporating a line cord connector, such as the Corcom EC, ED, or EF power line filter series.

How Do You Know Which Filter To Test?

A filter, or ordered group of filters, likely to solve your interference control problem can be obtained by using the selector chart at the front of each section. Every Corcom filter series is available in a range of current ratings and packages. Detailed specifications, including prices, are listed on the individual series' catalog sheets referenced in the selector chart. Telephone numbers of distributors who stock all TE products are listed on the back cover of this catalog.

Why Be Concerned with Safety Agency Requirements?

All components in the AC power system, including power line filters, must be safe from potential fire and shock hazard. The standards set by the various safety agencies, like UL, CSA, VDE, and SEV, provide guidelines to assist the designer in specifying safe and reliable components. Components which carry the compliance symbols from these agencies have been designed and manufactured to comply with these standards. A summary of safety agency requirements can be found in Appendix C.

Understanding RFI Power Line Filters *(continued)*

What are the significant requirements of UL and CSA?

UL and CSA are primarily concerned with high potential withstand capability, temperature rise, creepage distances, and material temperature capability at the time of manufacture.

What are the additional aspects of VDE safety requirements?

In addition to the requirements of UL and CSA, VDE specifies limits of hipot, insulation resistance, and change of component values, at the conclusion of extreme environmental conditioning. The conditioning includes life tests at elevated temperatures, long term humidity, and temperature/humidity cycling. Components that bear the VDE symbol of safety have been designed and tested not only for initial safety but also for safety over the life of the product.

How Do You Specify a Power Line Filter?

The filter you have selected through system testing can best be specified by the data parameters found on the appropriate catalog page. Combining the product family parameters listed under the “specifi-

cations” with the package style and dimensional data from your specific filter will adequately define your selection.

Are there other parameters that need to be specified?

There are three additional requirements that are often specified. Below are our recommended values:

1. Insulation Resistance: 6000 M Ω @ 100VDC
2. Current Overload: 6 X rated current for 8 seconds
3. Humidity: 21 days at 40°C 95% RH

What are the test methods for verification of the important specification parameters?

Some filter specifications may be unfamiliar to you or may require slightly different measuring techniques than you have been using for other components. It is very important that supplier and customer use the same techniques for verification of electrical specifications, in order to assure an uninterrupted flow of quality components. Three specifications that must be clearly understood are hipot testing, leakage current, and insertion loss.

Understanding Hipot Testing

The term “hipot” is an acronym for “high potential.” Hipot testing stresses the insulation and capacitors of a filter assembly by applying a voltage much higher than is usually experienced in normal operation. The purpose of hipot specifications is to assure safety and reliability.

All the major safety agencies require hipot testing for qualification of power line filters, and also require that each production unit undergo hipot testing to verify the integrity of the line-to-ground components and insulation. Every Corcom filter is hipot tested twice: once during assembly and again after completion. Applying hipot testing as an incoming inspection procedure requires a thorough understanding of its uses and limitations.

Hipot test voltages are applied from each line (both lines tied together for VDE) to ground and from line-to-line. The line-to-ground voltages are always higher. Test voltages may be specified as AC or DC, with the DC voltages at least 1.414 times the AC voltages.

For incoming inspection testing, TE recommends using the voltages given as “hipot rating” for each filter in the catalog. These DC voltages will always be equal to or higher than the peak AC voltage carried by any safety agency whose approval the filter carries. A DC hipot test is generally used.

A variety of hipot testers is available from a number of manufacturers. The tester chosen should have at

least a 500VA rating.

The following precautions must be observed to insure the safety of the operator and the validity of the test:

1. THESE VOLTAGES CAN BE LETHAL—use the utmost safety precautions to protect the test operator.
2. The possibility of high surge currents and oscillatory overvoltage during sudden application of the test voltage requires some method of limiting the applied current or increasing the voltage comparatively slowly.
3. For AC hipot tests, use an oscillograph to monitor the applied voltage. The current limiting circuit may react with the filter circuit to distort the 60Hz waveform. This may produce a peak voltage that exceeds the expected peak value of a sinusoidal voltage having the specified rms value. The peak voltage should be 1.414 times the rms value. Higher voltages may cause unwarranted failures due to the peak currents exceeding the trip setting.
4. For line-to-line hipot testing, remember that most filters have a bleeder resistor (typical value 100k Ω to 10M Ω) to discharge the line-to-line capacitors. Be sure to set the trip point of the hipot tester above the current level that will flow through the bleeder resistor: 10mA is usually a safe value.

Understanding Leakage Current (Touch Current)

Leakage current (also referred to as “touch current”) is an important specification of power line filters. There has always been an undeserved negative connotation to this term. Leakage current is not a function of the quality of components, but is a direct function of the line-to-ground capacitance value. The larger the capacitance, the lower the impedance to common mode currents, and the greater the common mode interference rejection. Hence, leakage current is a measure of filter performance—the higher, the better.

Why, then, do safety agencies specify a maximum allowable leakage current? This is done in order to limit the magnitude of expected ground return currents. The line-to ground capacitors provide a path for 50/60Hz current to flow to the chassis. As long as the equipment is grounded, these currents will flow in the ground circuit and present no hazard. However, in the unlikely but always possible circumstance where the ground circuit is faulty, the earth connection may be established by the body of a person. If this should occur, the maximum leakage current specification limits the ground return current to a safe value, typically 0.5 to 5.0mA. The limits set by safety agencies are based on end user equipment specifications, such as those given below.

Capacitive Current Limits

<u>Country</u>	<u>Specification</u>	<u>Limits for Class I Grounded Equipment</u>
U.S.A.	UL 60950	3.5 mA, 120V, 60Hz
Canada	C22.2 No. 60950	3.5 mA, 120V, 60Hz
Europe	EN 60950	3.5 mA, 250V, 50Hz

Since the largest component of leakage current is usually from the power line filter, it is prudent to set a maximum leakage current limit for the filter itself. There has been a tendency in the industry to specify the minimum leakage current to comply with all agency requirements, usually 0.5mA. This specification decision should not be made arbitrarily, because often the size and cost of the filter can be reduced by allowing a greater maximum leakage current.

Figure 2: Leakage Current Measurement



Note that filter case must be floating, not grounded.

The circuit of Figure 2 illustrates the measurement technique for leakage current. The leakage limits apply to each side of the line independently. The test circuit provides the correct value by shunting the line-to-ground path that is not being measured by the millimeter impedance. This test is realistic, because power to a system is provided by a hot line and a neutral line, with the neutral basically at ground potential, thus providing no addition to the leakage.

Note that the leakage current is directly proportional to line voltage and frequency. Hence, it is unwise to specify an operation frequency greater than 60Hz (e.g., 400Hz) when leakage current limits must also be met.

Understanding Insertion Loss

What is insertion loss?

Insertion loss is the ratio (expressed in dB) of the signal voltage transferred from source to load without a filter, to the signal voltage transferred from source to load when the filter is inserted. As discussed above (“How Does a Power Line Interference Filter Work?”), insertion loss is not a measure of filter performance in the power line equipment environment.

How is it measured?

If the terminating impedances are standardized, then it becomes meaningful to measure insertion loss, but the results so obtained can be applied only to an identical circuit. The most popular set-up is to make the source and load impedances each 50 Ohms, resistive.

The most important aspect of insertion loss measurement is consistency. It is particularly critical that supplier and user employ the same measurement techniques. The standard method of insertion loss measurement used by TE is as follows:

Insertion loss is easily measured with a spectrum analyzer or tuned receiver and a tracking generator. A zero dB reference is established without the filter. Then the filter is inserted, and the attenuation provided over the desired frequency range is recorded.

For a power line filter we are interested in signal attenuation in two different modes:

Common Mode (CM) — signals present on both sides of the line (hot and neutral) referenced to ground.

Differential Mode (DM) — signals present on one side of the line, referenced to the other.

Accordingly, we may deal with CM insertion loss or DM insertion loss or both.

For the common mode, the line and neutral terminals are at the same potential (same magnitude and phase) and may be considered as being in parallel. CM current circulates between this pair and the common (ground) lead. CM insertion loss is measured by strapping the line and neutral terminals together on both sides of the filter (Figure 3). All CM insertion loss data published in the Corcom product catalog are measured this way. For differential mode, the signals on the line and neutral terminals are of the same magnitude but opposite phase. Current circulates between the line and neutral leads only. DM insertion loss is tested with 50 Ohm 180° power splitters as shown in Figure 4. All DM insertion loss data published in the Corcom product catalog are measured this way.

Figure 3: CM Insertion Loss Measurement



For differential mode, the signals on the line and neutral terminals are of the same magnitude but opposite phase. Current circulates between the line and neutral leads only. DM insertion loss is tested with 50 Ohm 180° power splitters as shown in Figure 4. All DM insertion loss data published in the Corcom product guide are measured this way.

Figure 4: DM Insertion Loss Measurement



Note that all signal leads in Figures 3 and 4 are 50 Ohm coaxial cables.

1. Make your 0dB reference measurement over the entire frequency range, not just at one or two points.
2. Make sure the filter case has a good RF ground connection.
3. Make sure the wiring to the load side of the filter is well separated from the wiring to the line side, to avoid RF coupling around the filter.

Understanding Insertion Loss *(continued)*

What can it be used for?

Standardized insertion loss data will not accurately predict a filter’s performance in your equipment. However, it does serve as an important tool for verifying product consistency through incoming inspection.

The criterion for acceptance would be that the measured insertion loss must either meet or exceed the

published data when tested in the standardized manner.

Accordingly, “typical” insertion loss data is not meaningful. The data to which you test should be minimum values. Most of the insertion loss data published by TE are guaranteed minimums, and as such can be tested for a positive indication of component consistency.

Appendix A - Conducted RFI Emissions Testing

Conducted RFI Emissions Testing

Since conducted emissions testing is usually done to insure that your equipment will comply with the limits of FCC Part 15 or EN55022, the test methods used should conform to the specifications of these two agencies. You will need the following equipment:

1. Shielded room, to allow measurement with minimal background interference.
2. Two 50 Ohm line impedance stabilization networks (LISNs), fixing the line-side impedances as mandated by FCC and CISPR.
3. Spectrum analyzer or tuned receiver, with CISPR quasipeak detector, covering the range from 10kHz to 30MHz.

Figure A2



Figure A1



The limits for FCC Part 15 and EN55022 are shown in Figure A2. To which one or more of these limits you will test is determined by whether your equipment is marketed in the United States (FCC) or Europe (EN55022) and into which class of operation it falls at each agency.

Appendix B - Conducted RFI Susceptibility Testing

Conducted RFI Susceptibility Testing

You can determine whether or not your equipment is susceptible to conducted RFI by subjecting it to predetermined levels of CM and DM interferences, and noting any malfunctions that occur. Such a test approximates real-world interference by standardized test conditions, according to previous experience. TE's recommendation for conducted susceptibility testing follows. The equipment required will be:

1. Shielded room, to eliminate spurious signals.
2. Two 50 Ohm line impedance stabilization networks (LISNs).
3. 50 Ohm signal generator, 1 Watt output.
4. 50 Ohm (or less) pulse generator, 0 to 300 Volts output.

CW signals should be injected common-mode, using peak levels of:

- 7 Volts from 10kHz to 150kHz
- 2 Volts from 150kHz to 500kHz
- 1 Volt from 500kHz to 30MHz

Pulse waveforms should be injected common mode and differential mode, pulse width 10 microseconds, rise time 1 microsecond, repetition rate 60Hz and varied in phase 0 to 360 degrees on the 60Hz power waveform. CM pulses should have peak levels of 2 volts; DM pulses should have peak levels of twice the rated line voltage.

These levels are based on emission data gathered at TE and are considered typical of the levels encountered close to high noise sources.

Figure A3

A. Common Mode



B. Differential Mode



Appendix C - Health Care Equipment

UL 60601-1 Medical Electrical Equipment

The major safety standard for electro-medical devices is the IEC 60601 series, with the IEC 60601-1 standard covering all generic requirements. This standard is the basis of the various harmonized equivalents, the European equivalent is EN 60601, the UL equivalent is UL60601-1 and the CSA equivalent is C22.2 No. 60601-1

Underwriters Laboratories' medical electrical equipment specification is broken down into two basic categories.

A. Patient Care Equipment: "Equipment that is intended to be used on or with, or likely to be contacted by, a patient in a health care facility in the course of his treatment." This equipment can have a maximum leakage current of 100 μ A at 120VAC, 60Hz.

B. Non-patient Equipment: "Equipment primarily for use in a health care facility that is intended for use where contact with a patient is unlikely." This equipment can have a maximum leakage current of 300 μ A at 120VAC, 60Hz.

All filters starting with "H" and "M" are for medical equipment applications. They can be used in both patient care equipment and non-patient equipment. All other Corcom products with an "E" in the part number are suitable for use only in (120V) non-patient equipment.

Appendix D - Safety Agency File Numbers

Filters



UL Recognition

Guide FOKY2, File E48570
All except IK series
Guide ECBT2, File E106884
Non-filtered DB Series connectors only



Component Recognized by UL to Canadian Requirements

Guide ECBT8, File E106884
Non-filtered DB Series connectors only



Component Recognized by UL to Canadian Requirements

UL Guide FOKY2, File E48570
CSA Guide FOKY8, File E48570
AFC, FFA, FFD and DFC Series only



UL Listing

Guide FNFT, File E117533
Model 3FL3 ballast filter



CSA Certification

Class 2221, File LR46870
All except IK series



VDE Approval

File 706400-4730
All except IK series



TUV Approval

File E2173035
DAF, DAS Series
File E2173028.01
DCB, DCF Series
File T72091763.01
Filtered DB Series
File T72081913.01
Non-filtered DB Series (Connectors)

Signal Sentry Modular Jacks



UL Recognition

Guide DUXR2, File E136872



CSA Certification

Class 4872, File LR96220

Power Entry Modules



UL Recognition

Guide FOKY2, File E48570
All filtered power entry modules
Guide AXUT2, File E61290
All non-filtered fuseless modules and 15SRB with suffix 1, 2, 8, P, S1 or S8
Guide AYVZ2, File E59193
All non-filtered fused modules



Component Recognized by UL to Canadian Requirements

Guide AXUT8, File E61290
Models: 15CE1, 15CS1, 15CBE1, 15CBS1 and 15CU Series



CSA Certification

Class 2221, File LR46870
Filtered modules
Class 6221, File LR68190
Non-filtered modules



TUV Approval

File T72051210.01
Non-filtered DC rated P Series with VDE rating only



VDE Approval

File 706400-4730
All filtered modules except J Series
File 706400-1550
All non-filtered modules except J Series

Accessories



UL Recognition

Guide ECBT2, File E106884
MA100
Guide XUHT2 File E106794
TS Series



CSA Certification

Class 6233, File LR88865
MA100

Engineering Notes



Part Number Index and Cross Reference

Catalog Number	TE Ordering Number	Page Number	Catalog Number	TE Ordering Number	Page Number
1CFE1	6609113-1	130	1EGG8C-2	6609115-9	166
1CFS1	6609113-2	130	1EGS1-1	6609117-1	166
1CHE1	6609114-1	130	1EGS1-2	6609117-2	166
1CHS1	6609114-2	130	1EHG1-2	6609116-1	166
1CUFE1	2-1609113-2	134	1EHG8-2	1-1609117-4	166
1CUFF1	2-1609114-2	134	1EHGS1-2	1609988-1	166
1CUFS1	2-1609113-7	134	1EJH1	6609008-1	154
1EAH1	6609002-1	149	1EJH2	6609008-6	154
1EAS1	6609005-6	149	1EJH8	2-6609008-8	154
1EB1	6609020-1	15	1EJHP	6609008-7	154
1EB3	6609020-2	15	1EJHS1	1-6609008-6	154
1EBF1	6609018-1	138	1EJHS8	2-6609008-2	154
1EBF4	6609018-2	138	1EJM1	6609985-1	154
1EBH1	6609003-1	149	1EJM8	1-6609985-3	154
1EBP	6609063-1	21	1EJMS1	6609985-7	154
1EBS1	1-6609005-1	149	1EJMS8	1-6609985-8	154
1EC1	6609017-1	141	1EJS1	6609006-4	154
1EC2	6609017-2	141	1EJS8	3-6609006-7	154
1EC4	6609017-3	141	1EJT1	2-6609006-1	163
1EC8	6609017-4	141	1EJT8	2-6609006-6	163
1ED1	6609016-1	144	1EK1	6609027-1	49
1ED2	6609016-2	144	1EK3	6609027-2	49
1ED4	6609016-3	144	1EOP	6609064-1	21
1ED8	6609016-4	144	1ER1	6609031-1	61
1EDK1	6609033-1	18	1ER3	6609031-2	61
1EDK3	6609033-2	18	1EZP	6609062-1	92
1EDP	6609065-1	21	1IK1C	1-6609085-1	46
1EEA1	6609000-1	149	1VB1	6609021-1	15
1EEA2	6609000-2	149	1VB3	6609021-2	15
1EEAP	6609000-3	149	1VDK1	6609034-1	18
1EEB1	6609001-1	149	1VDK3	6609034-2	18
1EEB2	6609001-2	149	1VK1	6609028-1	49
1EEBP	6609001-3	149	1VK3	6609028-2	49
1EEJ1	6609006-1	154	1VR1	6609032-1	61
1EEJ2	6609006-2	154	1VR3	6609032-2	61
1EEJ8	3-6609006-2	154	2EB1	6609020-3	15
1EEJP	6609006-3	154	2EB3	6609020-4	15
1EF1F	6609015-1	160	2EDL1S	6609122-1	176
1EF2F	6609015-2	160	2EDL1SC	6609122-2	176
1EF4	6609014-3	160	2EDL1SCM	6609122-3	176
1EF8	6609014-4	160	2EDL1SM	6609122-4	176
1EGG1-1	6609115-1	166	2EDL4	6609122-5	176
1EGG1-2	6609115-3	166	2EDL4C	6609122-7	176
1EGG1C-1	6609115-4	166	2EDL4CM	6609122-9	176
1EGG1C-2	6609115-5	166	2EDL4M	1-6609122-0	176
1EGG8-1	6609115-6	166	2EK1	6609027-3	49
1EGG8-2	6609115-7	166	2EK3	6609027-4	49
1EGG8C-1	6609115-8	166	2ER1	1609031-3	61

Part Number Index and Cross Reference

Catalog Number	TE Ordering Number	Page Number	Catalog Number	TE Ordering Number	Page Number
2ER3	6609031-4	61	3EEJ2	6609006-6	154
2EYP	6609061-2	92	3EEJ8	3-6609006-3	154
2EZP	6609062-2	92	3EEJP	6609006-7	154
2RJ11-6L-B	3-6609208-6	248	3EF1F	6609015-3	160
2VB1	6609021-3	15	3EF2F	6609015-4	160
2VB3	6609021-4	15	3EF4	6609014-7	160
2VK1	6609028-3	49	3EF8	6609014-8	160
2VK3	6609028-4	49	3EGG1-1	1-6609115-1	166
2VR1	6609032-3	61	3EGG1-2	1-6609115-2	166
2VR3	6609032-4	61	3EGG1C-1	1-6609115-3	166
3AYO1	6609066-1	111	3EGG1C-2	1-6609115-5	166
3CFE1	6609113-5	130	3EGG8-1	1-6609115-7	166
3CFS1	6609113-6	130	3EGG8-2	1-6609115-8	166
3CHE1	6609114-5	130	3EGG8C-1	1-6609115-9	166
3CHS1	6609114-6	130	3EGG8C-2	2-6609115-0	166
3CUFE1	2-1609113-3	134	3EGS1-1	6609117-3	166
3CUFF1	2-1609114-3	134	3EGS1-2	6609117-4	166
3CUFS1	2-1609113-8	134	3EH1	6609012-1	169
3DAF1	6609075-4	212	3EH3	6609012-2	169
3DAFP	6609075-3	212	3EHG1-2	6609116-2	166
3DAS1	1-6609075-7	212	3EHG8-2	1-1609117-5	166
3EAH1	6609002-2	149	3EHGS1-2	1609988-2	166
3EAS1	6609005-7	149	3EHQ1	6609054-1	37
3EB1	6609020-5	15	3EHQ3	6609054-2	37
3EB3	6609020-6	15	3EHQ8	6609054-3	37
3EBF1	6609018-3	138	3EHQ8M	6609054-4	37
3EBF4	6609018-4	138	3EHQ8M	6609054-4	37
3EBH1	6609003-2	149	3EHT1	6609053-1	40
3EBP	6609063-2	21	3EHT3	6609053-2	40
3EBS1	1-6609005-2	149	3EHT7	6609053-3	40
3EC1	6609017-5	141	3EHT7M	6609053-4	40
3EC2	6609017-6	141	3EHZ1	6609055-1	43
3EC4	6609017-7	141	3EJH1	6609008-2	154
3EC8	6609017-8	141	3EJH2	6609008-8	154
3ED1	6609016-5	144	3EJH8	2-6609008-9	154
3ED2	6609016-6	144	3EJHP	6609008-9	154
3ED4	6609016-7	144	3EJHS1	1-6609008-7	154
3ED8	6609016-8	144	3EJHS8	2-6609008-3	154
3EDK1	6609033-3	18	3EJM1	6609985-2	154
3EDK3	6609033-4	18	3EJM8	1-6609985-4	154
3EDP	6609065-2	21	3EJMS1	6609985-8	154
3EEA1	6609000-4	149	3EJMS8	1-6609985-9	154
3EEA2	6609000-5	149	3EJS1	6609006-8	154
3EEAP	6609000-6	149	3EJS8	3-6609006-8	154
3EEB1	6609001-4	149	3EJT1	2-6609006-2	163
3EEB2	6609001-5	149	3EJT8	2-6609006-7	163
3EEBP	6609001-6	149	3EK1	6609027-5	49
3EEJ1	6609006-5	154	3EK3	6609027-6	49

Part Number Index and Cross Reference

Catalog Number	TE Ordering Number	Page Number	Catalog Number	TE Ordering Number	Page Number
3EK7	6609027-7	49	3VK3	6609028-6	49
3EK7M	6609027-8	49	3VK7	6609028-7	49
3EMC1	1-6609037-1	24	3VK7M	6609028-8	49
3EMC3	1-6609037-8	24	3VQ1	6609049-1	58
3EOP	6609064-2	21	3VQ3	6609049-2	58
3EP1	6609037-1	27	3VQ8	6609049-3	58
3EP3	6609037-2	27	3VQ8M	6609049-4	58
3EP7	6609037-3	27	3VR1	6609032-5	61
3EP7M	6609037-4	27	3VR3	6609032-6	61
3EQ1	6609048-1	58	3VR7	6609032-7	61
3EQ3	6609048-2	58	3VR7M	6609032-8	61
3EQ8	6609048-3	58	3VS1	6609042-1	68
3EQ8M	6609048-4	58	3VSK1	6609036-1	75
3ER1	6609031-5	61	3VSK3	6609036-2	75
3ER3	6609031-6	61	3VSK7	6609036-3	75
3ER7	6609031-7	61	3VSK7M	6609036-4	75
3ER7M	6609031-8	61	3VV1	6609043-1	86
3ERK1	1-1609036-7	65	3VW1	6609044-1	86
3ESK1	6609035-1	75	3VW1	6609044-1	86
3ESK3	6609035-2	75	4EDL1S	1-6609122-1	176
3ESK7	6609035-3	75	4EDL1SC	1-6609122-2	176
3ESK7M	6609035-4	75	4EDL1SCM	1-6609122-3	176
3ET1	6609046-1	80	4EDL1SM	1-6609122-4	176
3ET3	6609046-2	80	4EDL4	1-6609122-5	176
3ET7	6609046-3	80	4EDL4C	1-6609122-6	176
3EX1	6609059-1	92	4EDL4CM	1-6609122-7	176
3EXLA2S	6609119-1	180	4EDL4M	1-6609122-8	176
3EXM1S	6609131-7	184	4EXP	6609060-4	92
3EXM4	6609131-8	184	4EYP	6609061-4	92
3EXM4S	6609131-9	184	4RJ11-6L-B	6609213-1	248
3EXP	6609060-3	92	5EB1	6609020-7	15
3EYP	6609061-3	92	5EB3	6609020-8	15
3EZ1	6609059-2	92	5EFLA2S	6609118-1	180
3EZLA2S	6609120-1	180	5EFM1	2-6609129-1	184
3EZM1S	6609132-8	184	5EFMIC	2-6609129-2	184
3EZM4	6609132-9	184	5EFM1S	2-6609129-3	184
3EZM4S	1-6609132-0	184	5EFM1SC	2-6609129-5	184
3EZP	6609062-3	92	5EFM4	2-6609129-6	184
3FL3	2-6609092-3	33	5EFM4C	2-6609129-7	184
3MV1	6609056-1	54	5EFM4S	2-6609129-8	184
3VAQ3	6609057-1	12	5EFM4SC	3-6609129-0	184
3VAQ8F	6609058-1	12	5EHM1	1-6609130-1	184
3VAQ8FS	6609058-2	12	5EHM1S	1-6609130-3	184
3VB1	6609021-5	15	5EHM4	1-6609130-4	184
3VB3	6609021-6	15	5EHM4S	1-6609130-5	184
3VDK1	6609034-3	18	5EK1	6609027-9	49
3VDK3	6609034-4	18	5EK3	1-6609027-0	49
3VK1	6609028-5	49	5EK7	1-6609027-1	49

Part Number Index and Cross Reference

Catalog Number	TE Ordering Number	Page Number	Catalog Number	TE Ordering Number	Page Number
5EK7M	1-6609027-2	49	6EDL1SM	2-6609122-2	176
5ER1	6609031-9	61	6EDL4	2-6609122-3	176
5ER3	1-6609031-0	61	6EDL4C	2-6609122-4	176
5ER7	1-6609031-1	61	6EDL4CM	2-6609122-5	176
5ER7M	1-6609031-2	61	6EDL4M	2-6609122-6	176
5VB1	6609021-7	15	6EDP	6609065-3	21
5VB3	6609021-8	15	6EEA1	6609000-7	149
5VK1	6609028-9	49	6EEA2	6609000-8	149
5VK3	1-6609028-0	49	6EEAP	6609000-9	149
5VK7	1-6609028-1	49	6EEB1	6609001-7	149
5VK7M	1-6609028-2	49	6EEB2	6609001-8	149
5VR1	6609032-9	61	6EEBP	6609001-9	149
5VR3	1-6609032-0	61	6EEJ1	6609006-9	154
5VR7	1-6609032-1	61	6EEJ2	1-6609006-0	154
5VR7M	1-6609032-2	61	6EEJ8	3-6609006-4	154
6AYO1	6609066-2	111	6EEJP	1-6609006-1	154
6CFE1	6609113-9	130	6EF1F	6609015-5	160
6CFS1	1-6609113-0	130	6EF2F	6609015-6	160
6CHE1	6609114-9	130	6EF4	1-6609014-1	160
6CHS1	1-6609114-0	130	6EF8	1-6609014-2	160
6CUFE1	2-1609113-4	134	6EG1	6609050-1	35
6CUFF1	2-1609114-4	134	6EGG1-1	2-6609115-2	166
6CUFS1	2-1609113-9	134	6EGG1-2	2-6609115-3	166
6DAF1	6609075-6	212	6EGG1C-1	2-6609115-4	166
6DAFP	6609075-5	212	6EGG1C-2	2-6609115-6	166
6DAS1	2-6609075-1	212	6EGG8-1	2-6609115-8	166
6EAH1	6609002-3	149	6EGG8-2	2-6609115-9	166
6EAS1	6609005-8	149	6EGG8C-1	3-6609115-0	166
6EBF1	6609018-5	138	6EGG8C-2	3-6609115-1	166
6EBF4	6609018-6	138	6EGS1-1	6609117-5	166
6EBH1	6609003-3	149	6EGS1-2	6609117-6	166
6EBS1	1-6609005-3	149	6EH1	6609012-3	169
6EC1	6609017-9	141	6EH3	6609012-4	169
6EC2	1-6609017-0	141	6EH4	6609013-1	169
6EC4	1-6609017-1	141	6EH5	6609013-4	169
6EC8	1-6609017-2	141	6EH8	6609013-3	169
6ED1	6609016-9	144	6EH9	6609013-2	169
6ED1C	1-6609016-1	144	6EHG1-2	6609116-3	166
6ED2	1-6609016-0	144	6EHG8-2	1-1609117-6	166
6ED4	1-6609016-2	144	6EHGS1-2	1609988-3	166
6ED4C	1-6609016-4	144	6EHL1S	6609123-1	176
6ED8	1-6609016-3	144	6EHL1SC	6609123-2	176
6ED8C	1-6609016-5	144	6EHL1SCM	6609123-3	176
6EDK1	6609033-5	18	6EHL1SM	6609123-4	176
6EDK3	6609033-6	18	6EHL4	6609123-5	176
6EDL1S	1-6609122-9	176	6EHL4C	6609123-6	176
6EDL1SC	2-6609122-0	176	6EHL4CM	6609123-7	176
6EDL1SCM	2-6609122-1	176	6EHL4M	6609123-8	176

Part Number Index and Cross Reference

Catalog Number	TE Ordering Number	Page Number	Catalog Number	TE Ordering Number	Page Number
6EHQ1	6609054-5	37	6ESRM-P	1609078-1	201
6EHQ3	6609054-6	37	6ET1	6609046-4	80
6EHQ8	6609054-7	37	6ET3	6609046-5	80
6EHT1	6609053-5	40	6ET7	6609046-6	80
6EHT3	6609053-6	40	6EU1	6609045-2	84
6EHT7	6609053-7	40	6EUP	6609045-1	84
6EHT7M	6609053-8	40	6EXP	6609060-6	92
6EJH1	6609008-3	154	6FC10	6609069-1	30
6EJH2	1-6609008-0	154	6FCD10	6609070-1	119
6EJH8	3-6609008-0	154	6HJ4-2	6609126-1	172
6EJHP	1-6609008-1	154	6HJ4-4	6609126-2	172
6EJHS1	1-6609008-8	154	6IK1	1609973-4	46
6EJHS8	2-6609008-4	154	6J4	6609125-1	172
6EJM1	6609985-3	154	6J4-2	6609125-2	172
6EJM8	1-6609985-5	154	6MV1	6609056-2	54
6EJMS1	6609985-9	154	6RJ11-6L-B	6609213-2	248
6EJMS8	2-6609985-0	154	6VAQ3	6609057-3	12
6EJS1	1-6609006-2	154	6VAQ8F	6609058-3	12
6EJS8	3-6609006-9	154	6VAQ8FS	6609058-4	12
6EJT1	2-6609006-3	163	6VDK1	6609034-5	18
6EJT8	2-6609006-8	163	6VDK3	6609034-6	18
6EL1S	6609121-1	176	6VG1	6609051-1	35
6EL1SC	6609121-2	176	6VJ1	6609124-1	172
6EL1SCM	6609121-3	176	6VJ1-2	6609124-2	172
6EL1SM	6609121-4	176	6VM1	2-6609128-6	184
6EL4	6609121-5	176	6VM1C	2-6609128-7	184
6EL4C	6609121-6	176	6VM1S	2-6609128-8	184
6EL4CM	6609121-7	176	6VM1SC	2-6609128-9	184
6EL4M	6609121-8	176	6VM2	3-6609128-0	184
6EMC1	1-6609037-2	24	6VM2S	3-6609128-1	184
6EMC3	1-6609037-9	24	6VM4	3-6609128-3	184
6EOP	6609064-3	21	6VM4C	3-6609128-4	184
6EP1	6609037-5	27	6VM4S	3-6609128-5	184
6EP3	6609037-6	27	6VM4SC	3-6609128-7	184
6EQ1	6609048-5	58	6VN1	6609052-1	56
6EQ3	6609048-6	58	6VS1	6609042-2	68
6EQ8	6609048-7	58	6VSB1	1-1609034-2	71
6EQ8M	6609048-8	58	6VSK1	6609036-5	75
6ERK1	1-1609036-8	65	6VSK3	6609036-6	75
6ESB1	1-1609034-1	71	6VSK7	6609036-7	75
6ESK1	6609035-5	75	6VSK7M	6609036-8	75
6ESK3	6609035-6	75	6VV1	6609043-2	86
6ESK7	6609035-7	75	7BCF10	1609989-1	113
6ESK7M	6609035-8	75	7EP1	2-6609037-4	27
6ESRF-3	1609133-1	201	7EP3	2-6609037-5	27
6ESRFC3	1609133-2	201	10AFC6-A	1609990-1	236
6ESRM-3	1609133-3	201	10AFC6-B	1609990-2	236
6ESRMC2	1609133-4	201	10AYO1	6609066-3	111

Part Number Index and Cross Reference

Catalog Number	TE Ordering Number	Page Number	Catalog Number	TE Ordering Number	Page Number
10CBE1	1609112-1	130	10EH1	6609012-5	169
10CBS1	1609112-2	130	10EH3	6609012-6	169
10CE1	1609112-3	130	10EH4	6609013-5	169
10CFE1	1-6609113-3	130	10EH4C	6609013-6	169
10CFS1	1-6609113-4	130	10EHG1-2	6609116-4	166
10CHE1	1-6609114-3	130	10EHG8-2	6609116-5	166
10CHS1	1-6609114-4	130	10EHGS1-2	1609116-6	166
10CS1	1609112-8	130	10EHT1	6609053-9	40
10CUFE1	2-1609113-5	134	10EHT3	1-6609053-0	40
10CUFF1	2-1609114-5	134	10EJH1	6609008-4	154
10CUFS1	2-1609114-0	134	10EJH2	1-6609008-2	154
10DAF1	6609075-8	212	10EJH8	3-6609008-1	154
10DAFP	6609075-7	212	10EJHP	1-6609008-3	154
10DAS1	2-6609075-5	212	10EJHS1	1-6609008-9	154
10DFC6-C	1609992-1	239	10EJHS8	2-6609008-5	154
10EAH1	6609002-5	149	10EJM1	6609985-4	154
10EAS1	6609005-9	149	10EJM8	1-6609985-6	154
10EB1	6609020-9	15	10EJMS1	1-6609985-0	154
10EB3	1-6609020-0	15	10EJMS8	2-6609985-1	154
10EBF1	6609018-7	138	10EJS1	1-6609006-6	154
10EBF4	6609018-8	138	10EJS8	4-6609006-0	154
10EBH1	6609003-4	149	10EJT1	2-6609006-4	163
10EBS1	1-6609005-4	149	10EJT8	2-6609006-9	163
10EC1	1-1609017-3	141	10EK1	1-6609027-3	49
10ED1	1-6609016-6	144	10EK3	1-6609027-4	49
10ED1C	1-6609016-7	144	10EK7	1-6609027-5	49
10EDK1	6609033-7	18	10EK7M	1-6609027-6	49
10EDK3	6609033-8	18	10EMC1	1-6609037-3	24
10EDP	6609065-4	21	10EMC3	2-6609037-0	24
10EEA1	1-6609000-0	149	10EMC6	2-6609037-1	24
10EEA2	1-6609000-1	149	10EOP	6609064-4	21
10EEAP	1-6609000-2	149	10EP1	6609037-7	27
10EEB1	1-6609001-0	149	10EP3	6609037-8	27
10EEB2	1-6609001-1	149	10ER1	1-6609031-3	61
10EEBP	1-6609001-2	149	10ER3	1-6609031-4	61
10EEJ1	1-6609006-3	154	10ER7	1-6609031-5	61
10EEJ2	1-6609006-4	154	10ER7M	1-6609031-6	61
10EEJ8	3-6609006-5	154	10ERK1	2-1609089-5	65
10EEJP	1-6609006-5	154	10ESB1	1-1609034-3	71
10EFIF	6609015-7	160	10ESB6	1-1609034-4	71
10EFIFC	6609015-8	160	10ESK1	6609035-9	75
10EG1	6609050-2	35	10ESK3	1-6609035-0	75
10EGG1-1	3-1609115-4	166	10ESK7	1-6609035-1	75
10EGG1-2	3-1609115-3	166	10ESK7M	1-6609035-2	75
10EGG8-1	3-1609115-5	166	10ET1	6609046-7	80
10EGG8-2	3-1609115-6	166	10ET3	6609046-8	80
10EGS1-1	1609117-7	166	10FFA6-BA	1609991-1	230
10EGS1-2	1609117-8	166	10FFA6-CE	1609991-9	230

Part Number Index and Cross Reference

Catalog Number	TE Ordering Number	Page Number	Catalog Number	TE Ordering Number	Page Number
10FFA6-GJ	1-1609991-8	230	15CUE1	2-1609114-7	134
10FFD6-CA	1609993-1	233	15CUFE1	2-1609113-6	134
10FFD6-HE	1609993-7	233	15CUFF1	2-1609114-6	134
10MV1	6609056-3	54	15CUFS1	2-1609114-1	134
10VB1	6609021-9	15	15CUS1	2-1609114-9	134
10VB3	1-6609021-0	15	15DAF1	1-6609075-0	212
10VB6	1-6609021-2	15	15DAFP	6609075-9	212
10VDK1	6609034-7	18	15DAS1	2-6609075-9	212
10VDK3	6609034-8	18	15DCB10	4-6609074-1	218
10VG1	6609051-2	35	15DCB10B	4-6609074-3	218
10VK1	1-6609028-3	49	15DCB10BF	4-6609074-4	218
10VK3	1-6609028-4	49	15DCB10F	4-6609074-2	218
10VK6	1-6609028-8	49	15DCB6	2-6609074-1	218
10VK7	1-6609028-5	49	15DCB6B	2-6609074-3	218
10VK7M	1-6609028-6	49	15DCB6BF	2-6609074-4	218
10VNI	6609052-2	56	15DCB6F	2-6609074-2	218
10VR1	1-6609032-3	61	15DCF10	1-6609074-1	218
10VR3	1-6609032-4	61	15DCF10B	1-6609074-2	218
10VR6	1-6609032-5	61	15DCF6	6609074-1	218
10VR7	1-6609032-6	61	15DCF6B	6609074-2	218
10VR7M	1-6609032-7	61	15ED1	1-6609016-8	144
10VS1	6609042-3	68	15ED8	1-6609016-9	144
10VSB1	1-1609034-5	71	15EEJ1	1-6609006-7	154
10VSB6	1-1609034-6	71	15EEJ2	1-6609006-9	154
10VSK1	6609036-9	75	15EEJ8	3-6609006-6	154
10VSK3	1-6609036-0	75	15EEJP	2-6609006-0	154
10VSK7	1-6609036-1	75	15EF1F	6609015-9	160
10VSK7M	1-6609036-2	75	15EH4	6609013-7	169
10VT1	6609047-1	80	15EHT1	1-6609053-1	40
10VT3	6609047-2	80	15EHT6	1-6609053-2	40
10VV1	6609043-3	86	15EJH1	6609008-5	154
10VW1	6609044-3	86	15EJH2	1-6609008-4	154
12EP1	2-6609037-6	27	15EJH8	3-6609008-2	154
12EP3	2-6609037-7	27	15EJHP	1-6609008-5	154
12FC10	6609069-2	30	15EJHS1	2-6609008-0	154
12FC10B	1609976-3	30	15EJHS8	2-6609008-6	154
12FCD10	6609070-2	119	15EJM1	6609985-5	154
12FCD10B	6609974-4	119	15EJM8	1-6609985-7	154
15CBE1	1-1609112-4	130	15EJMS1	1-6609985-1	154
15CBS1	1-1609112-3	130	15EJMS8	2-6609985-2	154
15CE1	1-1609112-2	130	15EJS1	1-6609006-8	154
15CS1	1-1609112-1	130	15EJS8	4-6609006-1	154
15CU10BS1	1-1609112-7	134	15EJT1	2-6609006-5	163
15CU10S1	1-1609112-6	134	15EJT8	3-6609006-0	163
15CU15BS1	1-1609112-9	134	15EMC1	1-6609037-4	24
15CU15S1	1-1609112-8	134	15EMC3	2-6609037-2	24
15CUBE1	2-1609114-8	134	15EMC6	2-6609037-3	24
15CUBS1	1-1609112-5	134	15ERK1	2-1609089-6	65

Part Number Index and Cross Reference

Catalog Number	TE Ordering Number	Page Number	Catalog Number	TE Ordering Number	Page Number
15ET1	6609046-9	80	15SRBS8-S	3-6609987-0	204
15ET6	1-6609046-0	80	15SRBS8-T	3-6609987-1	204
15SRB1	6609987-9	204	15SRBS8-W	3-6609987-2	204
15SRB1-Q	6609987-1	204	15SRBS8-X	3-6609987-3	204
15SRB1-R	6609987-2	204	15SRBX8	5-1609987-6	204
15SRB1-S	6609987-3	204	15SRBX8-Q	5-1609987-7	204
15SRB1-T	6609987-4	204	15SRBX8-R	5-1609987-8	204
15SRB1-W	6609987-5	204	15SRBX8-S	5-1609987-9	204
15SRB1-X	6609987-6	204	15SRBX8-T	6-1609987-0	204
15SRB1-Y	6609987-7	204	15SRBX8-W	6-1609987-1	204
15SRB1-Z	6609987-8	204	15SRBX8-X	6-1609987-2	204
15SRB2	5-6609987-4	204	15SRBY8	6-1609987-5	204
15SRB2-Q	4-6609987-6	204	15SRBY8-Q	6-1609987-6	204
15SRB2-R	4-6609987-7	204	15SRBY8-R	6-1609987-7	204
15SRB2-S	4-6609987-8	204	15SRBY8-S	6-1609987-8	204
15SRB2-T	4-6609987-9	204	15SRBY8-T	6-1609987-9	204
15SRB2-W	5-6609987-0	204	15SRBY8-W	7-1609987-0	204
15SRB2-X	5-6609987-1	204	15SRBY8-X	7-1609987-1	204
15SRB2-Y	5-6609987-2	204	15VT1	6609047-3	80
15SRB2-Z	5-6609987-3	204	15VT6	6609047-4	80
15SRB8	1-6609987-8	204	16AFC6-B	1609990-3	236
15SRB8-Q	1-6609987-0	204	16AFC6-C	1609990-4	236
15SRB8-R	1-6609987-1	204	16AFC6-G	1609990-5	236
15SRB8-S	1-6609987-2	204	16AFC6-H	1609990-6	236
15SRB8-T	1-6609987-3	204	16AYA10	6609977-1	104
15SRB8-W	1-6609987-4	204	16AYA6	6609068-1	104
15SRB8-X	1-6609987-5	204	16AYA6A	6609068-2	104
15SRBP	4-6609987-5	204	16AYC10B	6609067-1	108
15SRBP-Q	3-6609987-7	204	16BCF10	1609989-2	113
15SRBP-R	3-6609987-8	204	16DFC6-C	1609992-2	239
15SRBP-S	3-6609987-9	204	16DFC6-G	1609992-3	239
15SRBP-T	4-6609987-0	204	16DFC6-H	1609992-4	239
15SRBP-W	4-6609987-1	204	16DFC6-N	1609992-5	239
15SRBP-X	4-6609987-2	204	16FC10	6609069-3	30
15SRBP-Y	4-6609987-3	204	16FC10B	1609976-1	30
15SRBP-Z	4-6609987-4	204	16FCD10	6609070-3	119
15SRBS1	2-6609987-7	204	16FCD10B	6609974-5	119
15SRBS1-Q	1-6609987-9	204	16FFA6-CA	1609991-2	230
15SRBS1-R	2-6609987-0	204	16FFA6-DG	1-1609991-1	230
15SRBS1-S	2-6609987-1	204	16FFA6-HN	1-1609991-9	230
15SRBS1-T	2-6609987-2	204	16FFD6-CA	1609993-2	233
15SRBS1-W	2-6609987-3	204	16FFD6-HE	1609993-8	233
15SRBS1-X	2-6609987-4	204	16IK10	6609973-1	46
15SRBS1-Y	2-6609987-5	204	16WGA1	2-6609089-4	89
15SRBS1-Z	2-6609987-6	204	16WGA3	7-6609089-6	89
15SRBS8	3-6609987-6	204	16WGA7	3-1609090-8	89
15SRBS8-Q	2-6609987-8	204	16WGB1	4-6609089-0	89
15SRBS8-R	2-6609987-9	204	16WGB3	7-6609089-7	89

Part Number Index and Cross Reference

Catalog Number	TE Ordering Number	Page Number	Catalog Number	TE Ordering Number	Page Number
16WGB7	3-1609090-9	89	20VK6	1-6609028-9	49
16WGC1	4-6609089-1	89	20VP1	6609038-1	27
16WGC3	7-6609089-8	89	20VP6	6609038-2	27
16WGC7	4-1609090-0	89	20VQ1	6609049-5	58
16WGD1	4-6609089-6	89	20VR1	1-6609032-8	61
16WGD3	7-6609089-9	89	20VR6	1-6609032-9	61
16WGD7	4-1609090-1	89	20VS1	6609042-4	68
16WGE1	4-6609089-7	89	20VS6	6609042-5	68
16WGE3	8-6609089-0	89	20VSB1	1-1609034-9	71
16WGE7	4-1609090-2	89	20VSB6	2-1609034-0	71
16WGF1	4-6609089-8	89	20VSK6	1-6609036-3	75
16WGF3	8-6609089-1	89	20VT1	6609047-5	80
16WGF7	4-1609090-3	89	20VT6	6609047-6	80
20AFC6-B	1609990-7	236	20VV1	6609043-4	86
20AYO1	6609066-4	111	20VV6	6609043-5	86
20AYP6C	6609072-1	99	20VW1	6609044-4	86
20AYT6C	6609073-1	99	20VW6	6609044-5	86
20EB1	1-6609020-1	15	25AYA6	6609068-3	104
20EDK1	6609033-9	18	25AYA6A	6609977-2	104
20EEJ1	6609007-3	154	25AYC10B	6609068-4	108
20EEJ8	6609007-6	154	25FC10	6609069-4	30
20EJH1	6609009-4	154	25FC10B	6609976-2	30
20EJH8	6609009-5	154	25FCD10	6609070-4	119
20EJS1	6609007-5	154	25FCD10B	6609974-9	119
20EJS8	6609007-7	154	30AYP6C	6609072-2	99
20EJT1	6609007-8	163	30AYT6C	6609073-2	99
20EJT8	3-6609006-1	163	30BCF10	1609989-3	113
20EK1	1-6609027-7	49	30DCB10	4-6609074-5	218
20EMC1	1-6609037-5	24	30DCB10B	4-6609074-7	218
20EMC6	1-6609037-7	24	30DCB10BF	4-6609074-8	218
20EP1	6609037-9	27	30DCB10F	4-6609074-6	218
20EP6	1-6609037-0	27	30DCB6	2-6609074-5	218
20EQ1	6609048-9	58	30DCB6B	2-6609074-7	218
20ER1	1-6609031-7	61	30DCB6BF	2-6609074-8	218
20ERK1	2-1609089-7	65	30DCB6F	2-6609074-6	218
20ESB1	1-1609034-7	71	30DCF10	1-6609074-3	218
20ESB6	1-1609034-8	71	30DCF10B	1-6609074-4	218
20ESK6	1-6609035-3	75	30DCF6	6609074-3	218
20ESRM-3	4-1609134-7	201	30DCF6B	6609074-4	218
20ESRMC2	4-1609134-8	201	30EMC6	1-6609037-6	24
20ET1	1-6609046-1	80	30ESB6	2-1609034-1	71
20ET6	1-6609046-2	80	30ESK6	1-6609035-4	75
20MV1	6609056-4	54	30ESK6C	1-6609035-5	75
20VB1	1-6609021-1	15	30VB6	1-6609021-4	15
20VB6	1-6609021-3	15	30VK6	2-6609028-0	49
20VDK1	6609034-9	18	30VK6C	2-6609028-1	49
20VDK6	1-6609034-0	18	30VSB6	2-1609034-2	71
20VK1	1-6609028-7	49	30VSK6	1-6609036-4	75

Part Number Index and Cross Reference

Catalog Number	TE Ordering Number	Page Number	Catalog Number	TE Ordering Number	Page Number
30VSK6C	1-6609036-5	75	60DBPL9	5-1609075-1	214
32AFC6-B	1609990-8	236	60DBR	5-1609075-6	214
32AFC6-C	1609990-9	236	60DBRL1	6-1609075-4	214
32AFC6-F	1-1609990-1	236	60DBRL3	6-1609075-5	214
32AFC6-G	1-1609990-2	236	60DBX8	4-1609075-7	214
32AFC6-H	1-1609990-3	236	60DCB10	4-6609074-9	218
32DFC6-C	1609992-6	239	60DCB10B	5-6609074-1	218
32DFC6-G	1609992-7	239	60DCB10BF	5-6609074-2	218
32DFC6-H	1609992-8	239	60DCB10F	5-6609074-0	218
32DFC6-N	1609992-9	239	60DCB6	2-6609074-9	218
32FFA6-CA	1609991-3	230	60DCB6B	3-6609074-1	218
32FFA6-DH	1-1609991-2	230	60DCB6BF	3-6609074-2	218
32FFA6-HN	2-1609991-1	230	60DCB6F	3-6609074-0	218
32FFD6-CA	1609993-3	233	60DCF10	1-6609074-5	218
32FFD6-HE	1609993-9	233	60DCF10B	1-6609074-6	218
35IK10	6609973-2	46	60DCF6	6609074-5	218
36AYA10	6609068-6	104	60DCF6B	6609074-6	218
36AYA6	6609068-5	104	60VK6	2-6609028-5	49
36AYA6A	6609977-3	104	60VS6	1609042-6	68
36AYC10B	6609067-2	108	63ADT6	1609071-2	101
36FC10	6609069-5	30	63ADT6S	1609071-1	101
36FC10B	1609976-4	30	63AFC6-C	1-1609990-4	236
36FCD10	6609070-5	119	63AFC6-G	1-1609990-5	236
36FCD10B	1-6609974-1	119	63AFC6-H	1-1609990-6	236
40VK6	2-6609028-3	49	63AYA10	1609977-5	104
40VK6C	2-6609028-4	49	63AYA6A	6609977-8	104
40VSK6	1-6609036-6	75	63AYC10B	6609067-3	108
42BCF10	1609989-4	113	63DFC6-C	1-1609992-1	239
45AYP6C	6609072-3	99	63DFC6-G	1-1609992-2	239
45AYT6C	6609073-3	99	63DFC6-H	1-1609992-3	239
50AYA6	6609068-7	104	63DFC6-N	1-1609992-4	239
50AYA6A	6609068-8	104	63FFA6-GB	1609991-4	230
50FC10	6609069-6	30	63FFA6-JK	1-1609991-3	230
50FC10B	6609069-7	30	63FFA6-NP	2-1609991-2	230
50FCD10	6609070-6	119	63FFD6-HB	1609993-4	233
50FCD10B	1-6609974-3	119	63FFD6-NH	1-1609993-1	233
50FCD10BS	1-6609974-6	119	75BCF10	1609989-6	113
50FCD10BS	1-6609974-6	119	80AYC10B	6609067-4	108
50IK10	1609973-5	46	80FCD10B	6609070-7	119
55BCF10	1609989-5	113	80FCD10BS	1-6609974-7	119
60AYP6C	6609072-4	99	80IK10	6609973-3	46
60AYT6C	6609073-4	99	100ADT6	1609071-4	101
60DB8	4-1609075-4	214	100ADT6S	1609071-3	101
60DBF8	4-1609075-5	214	100AFC6-H	1-1609990-8	236
60DBJ8	4-1609075-6	214	100AFC6-H	1-1609990-8	236
60DBP	5-1609075-7	214	100AFC6-K	1-1609990-9	236
60DBPL1	4-1609075-9	214	100AFC6-N	2-1609990-1	236
60DBPL3	5-1609075-0	214	100AYA6A	6609977-7	104

Part Number Index and Cross Reference

Catalog Number	TE Ordering Number	Page Number	Catalog Number	TE Ordering Number	Page Number
100BCF10	1609989-7	113	180FCD10B	1-6609070-0	119
100DCB10	5-6609074-3	218	180FCD10BS	2-6609974-1	119
100DCB10B	5-6609074-5	218	200ADT6	1609071-8	101
100DCB10BF	5-6609074-6	218	200ADT6S	1609071-7	101
100DCB10F	5-6609074-4	218	200AFC6-H	2-1609990-2	236
100DCB6	3-6609074-3	218	200AFC6-K	2-1609990-3	236
100DCB6B	3-6609074-5	218	200AFC6-N	2-1609990-4	236
100DCB6BF	3-6609074-6	218	200AFC6-P	2-1609990-5	236
100DCB6F	3-6609074-4	218	200AYC10B	1609067-8	108
100DCF10	1-6609074-7	218	200DFC6-H	1-1609992-9	239
100DCF10B	1-6609074-8	218	200DFC6-N	2-1609992-1	239
100DCF6	6609074-7	218	200DFC6-P	2-1609992-2	239
100DCF6B	6609074-8	218	200DFC6-R	2-1609992-3	239
100DFC6-G	1-1609992-5	239	200FFA6-HD	1609991-6	230
100DFC6-H	1-1609992-6	239	200FFA6-NP	1-1609991-5	230
100DFC6-N	1-1609992-7	239	200FFA6-PP	2-1609991-4	230
100DFC6-P	1-1609992-8	239	200FFD6-ND	1609993-6	233
100FFA6-HC	1609991-5	230	200FFD6-RP	1-1609993-3	233
100FFA6-NP	1-1609991-4	230	230FCD10B	1-6609070-2	119
100FFA6-PP	2-1609991-3	230	230FCD10BS	3-6609974-6	119
100FFD6-NC	1609993-5	233	250AFC6-H	2-1609990-6	236
100FFD6-PK	1-1609993-2	233	250AFC6-K	2-1609990-7	236
110AYC10B	6609067-5	108	250AFC6-N	2-1609990-8	236
110FCD10B	6609070-8	119	250AFC6-P	2-1609990-9	236
110FCD10BS	1-6609974-8	119	250DFC6-P	2-1609992-4	239
125DCB10	5-6609074-7	218	250DFC6-Q	2-1609992-5	239
125DCB10B	5-6609074-9	218	250DFC6-T	2-1609992-6	239
125DCB10BF	6-6609074-0	218	250FFA6-HF	1609991-7	230
125DCB10F	5-6609074-8	218	250FFA6-NP	1-1609991-6	230
125DCB6	3-6609074-7	218	250FFA6-PP	2-1609991-5	230
125DCB6B	3-6609074-9	218	300AFC6-H	3-1609990-1	236
125DCB6BF	4-1609074-0	218	300AFC6-K	3-1609990-2	236
125DCB6F	3-6609074-8	218	300AFC6-N	3-1609990-3	236
125DCF10	1-6609074-9	218	300AFC6-P	3-1609990-4	236
125DCF10B	2-6609074-0	218	300CFN12	1609978-1	116
125DCF6	6609074-9	218	300DFC6-P	2-1609992-7	239
125DCF6B	1-6609074-0	218	300DFC6-Q	2-1609992-8	239
130BCF10	1609989-8	113	300DFC6-T	2-1609992-9	239
150AYC10B	6609067-6	108	300FFA6-HF	1609991-8	230
150AYC10B-95	1609067-7	108	300FFA6-NP	1-1609991-7	230
150FCD10B	6609070-9	119	300FFA6-PP	2-1609991-6	230
150FCD10B-95	3-6609974-3	119	400CFN12	1-1609979-7	116
150FCD10BS	2-6609974-0	119	500CFN12	6609978-3	116
150FCD10BS-95	1-6609974-9	119	600CFN12	6609978-4	116
160ADT6	1609071-6	101	PE000DD3D	6609110-1	223
160ADT6S	1609071-5	101	PE000DD6D	6609110-3	223
180AYC10B	6609977-6	108	PE000DDXD	6609110-5	223
180BCF10	1609989-9	113	PE000SD3D	6609110-2	223

Part Number Index and Cross Reference

Catalog Number	TE Ordering Number	Page Number	Catalog Number	TE Ordering Number	Page Number
PE000SD6D	6609110-4	223	RJ45-6L1-B	5-6609208-0	247
PE000SDXD	6609110-6	223	RJ45-6L1-S	4-6609208-9	247
PS000DD3D	6609111-3	223	RJ45-6L2-B	5-6609208-2	247
PS000DD6D	6609111-5	223	RJ45-6L2-S	5-6609208-1	247
PS000DDXD	6609111-7	223	RJ45-6L-B	4-6609208-8	247
PS000SD3D	6609111-4	223	RJ45-6LC1-B	2-6609209-7	249
PS000SD6D	6609111-6	223	RJ45-6LC1-S	2-6609209-6	249
PS000SDXD	6609111-8	223	RJ45-6LC2-B	2-6609209-9	249
RJ11-2L2-B	1-1609208-2	247	RJ45-6LC2-S	2-6609209-8	249
RJ11-2L-B	6609208-4	247	RJ45-6L-S	4-6609208-7	247
RJ11-2LC1-B	6609209-2	249	RJ45-6X	1-6609214-0	252
RJ11-2LC1-S	6609209-1	249	RJ45-8L1-B	5-6609208-7	247
RJ11-2LC2-B	6609209-4	249	RJ45-8L1-S	5-6609208-5	247
RJ11-2LC2-S	6609209-3	249	RJ45-8L2-B	6-6609208-0	247
RJ11-2L-S	6609208-1	247	RJ45-8L2-S	5-6609208-9	247
RJ11-2X	6609214-1	252	RJ45-8L-B	5-6609208-4	247
RJ11-4L1-B	2-1609208-2	247	RJ45-8LC1-B	3-6609209-3	249
RJ11-4L1-S	2-6609208-1	247	RJ45-8LC1-S	3-6609209-0	249
RJ11-4L2-B	2-6609208-7	247	RJ45-8LC2-B	4-6609209-1	249
RJ11-4L2-S	2-6609208-5	247	RJ45-8LC2-S	3-6609209-6	249
RJ11-4L-B	1-6609208-7	247	RJ45-8LCT1-B	1-6609211-1	250
RJ11-4LC1-B	6609209-8	249	RJ45-8LCT1-S	1-6609211-0	250
RJ11-4LC1-S	6609209-6	249	RJ45-8LCT2-B	1-6609211-3	250
RJ11-4LC2-B	1-6609209-3	249	RJ45-8LCT2-S	1-6609211-2	250
RJ11-4LC2-S	1-6609209-0	249	RJ45-8L-S	5-6609208-3	247
RJ11-4L-S	1-6609208-5	247	RJ45-8N3-B	1-6609212-3	251
RJ11-4X	6609214-3	252	RJ45-8N3-S	1-6609212-4	251
RJ11-6L1-B	4-6609208-0	247	RJ45-8N4-B	1-6609212-5	251
RJ11-6L1-S	3-6609208-8	247	RJ45-8N4-S	1-6609212-6	251
RJ11-6L2-B	4-6609208-5	247	RJ45-8N-B	1-6609212-0	251
RJ11-6L2-S	4-6609208-3	247	RJ45-8N-S	1-6609212-2	251
RJ11-6L-B	3-6609208-1	247	RJ45-8X	1-6609214-1	252
RJ11-6LC1-B	1-6609209-8	249	RJ45-8X1	1-6609210-4	252
RJ11-6LC1-S	1-6609209-6	249	RJ45-8X2	1-6609214-3	252
RJ11-6LC2-B	2-6609209-1	249	RJ45-8Z	6609215-4	253
RJ11-6LC2-S	2-6609209-0	249	RJ45-8Z3	6609215-5	253
RJ11-6LCT1-B	6609211-4	250	RJ45-8Z4	6609215-6	253
RJ11-6LCT1-S	6609211-1	250	RJH-4L-B	6-6609208-1	247
RJ11-6LCT2-B	6609211-8	250			
RJ11-6LCT2-S	6609211-6	250			
RJ11-6L-S	2-6609208-9	247			
RJ11-6N3-B	6609212-6	251			
RJ11-6N4-B	6609212-8	251			
RJ11-6N-B	6609212-4	251			
RJ11-6X	6609214-5	252			
RJ11-6Z	6609215-1	253			
RJ11-6Z3	6609215-2	253			
RJ11-6Z4	6609215-3	253			

Engineering Notes

A large, empty grid area for writing engineering notes, consisting of a uniform pattern of small squares.

North American Sales Representatives

ALABAMA

CARTWRIGHT & BEAN, INC. HUNTSVILLE, AL 800-242-5876

ALASKA

TE CONNECTIVITY MUNDELEIN, IL 847-573-6504

ARIZONA

LUSCOMBE ENGINEERING PHOENIX, AZ 602-678-1955

ARKANSAS

ELECTRA REPS PLANO, TX 972-599-2130

CALIFORNIA

LUSCOMBE ENGINEERING (SOUTH) CAMARILLO, CA 805-987-4880
 LUSCOMBE ENGINEERING (SOUTH) COSTA MESA, CA 714-546-4880
 LUSCOMBE ENGINEERING (SOUTH) SAN DIEGO, CA 858-385-2655
 STRAUBE ASSOCIATES (NORTH) MOUNTAIN VIEW, CA 650-969-6060

CANADA

WEISS COMPANY MONTREAL 514-337-6769
 WEISS COMPANY OTTAWA 613-599-8787
 WEISS COMPANY TORONTO 905-238-9548
 WEISS COMPANY VANCOUVER 604-276-8735

COLORADO

STRAUBE ASSOCIATES ROCKY MOUNTAINS, INC. WESTMINSTER, CO 303-426-0890

CONNECTICUT

CONTI-YOUNGER ASSOCIATES MARLBORO, MA 508-485-7204

DELAWARE

ASTROREP MID-ATLANTIC, INC. DOYLESTOWN, PA 267-880-6321

DISTRICT OF COLUMBIA

ASTROREP MID-ATLANTIC, INC. DOYLESTOWN, PA 267-880-6321

FLORIDA

CBX ELECTRONICS CASSELBERRY, FL 407-774-9100

GEORGIA

CARTWRIGHT & BEAN, INC. NORCROSS, GA 800-242-5876

ILLINOIS

RATHSBURG ASSOCIATES (NORTH) ITASCA, IL 630-625-5100
 RATHSBURG ASSOCIATES (SOUTH) ST. LOUIS, MO 636-946-1001

IDAHO

HALBAR-RTS, INC. KIRKLAND, WA 425-893-8400

INDIANA

RATHSBURG ASSOCIATES CARMEL, IN 317-818-7055

IOWA

RATHSBURG ASSOCIATES BLOOMINGTON, MN 952-893-1400

KANSAS

RATHSBURG ASSOCIATES OLATHE, KS 913-829-2800

KENTUCKY

RATHSBURG ASSOCIATES EASTERN 248-615-4000
 RATHSBURG ASSOCIATES WESTERN 317-818-7055

LOUISIANA

ELECTRA REPS PLANO, TX 972-599-2130

MAINE

CONTI-YOUNGER ASSOCIATES MARLBORO, MA 508-485-7204

MARYLAND

ASTROREP MID-ATLANTIC, INC. DOYLESTOWN, PA 267-880-6321

MASSACHUSETTS

CONTI-YOUNGER ASSOCIATES MARLBORO, MA 508-485-7204

MEXICO

TE CONNECTIVITY MUNDELEIN, IL 847-573-6504

MICHIGAN

RATHSBURG ASSOCIATES NOVI, MI 248-615-4000

MINNESOTA

RATHSBURG ASSOCIATES BLOOMINGTON, MN 952-893-1400

MISSISSIPPI

CARTWRIGHT & BEAN, INC. HUNTSVILLE, AL 800-242-5876

MISSOURI

RATHSBURG ASSOCIATES ST. LOUIS, MO 636-946-1001

MONTANA

HALBAR-RTS, INC. KIRKLAND, WA 425-893-8400

North American Sales Representatives

NEBRASKA

RATHSBURG ASSOCIATES OLATHE, KS 913-829-2800

NEVADA

STRAUBE ASSOCIATES MOUNTAIN VIEW, CA 650-969-6060
LUSCOMBE ENGINEERING (LAS VEGAS) PHOENIX, AZ 602-678-1955

NEW HAMPSHIRE

CONTI-YOUNGER ASSOCIATES MARLBORO, MA 508-485-7204

NEW JERSEY

ASTROREP MID-ATLANTIC, INC. (SOUTH) DOYLESTOWN, PA 267-880-6321
ASTROREP, INC. (NORTH) BABYLON, NY 631-422-2500

NEW MEXICO

LUSCOMBE ENGINEERING PHOENIX, AZ 602-678-1955

NEW YORK

EMPIRE TECHNICAL ASSOCIATES (UPSTATE) SKANEATELES, NY 315-685-5703
ASTROREP INC. BABYLON, NY 631-422-2500

NORTH CAROLINA

CARTWRIGHT & BEAN, INC. (WEST) CHARLOTTE, NC 800-242-5876
CARTWRIGHT & BEAN, INC. (EAST) RALEIGH, NC 800-242-5876

NORTH DAKOTA

RATHSBURG ASSOCIATES BLOOMINGTON, MN 952-893-1400

OHIO

RATHSBURG ASSOCIATES COLUMBUS, OH 248-615-4000

OKLAHOMA

ELECTRA REPS PLANO, TX 972-599-2130

OREGON

HALBAR-RTS, INC. BEAVERTON, OR 503-624-5741

PENNSYLVANIA

ASTROREP MID-ATLANTIC, INC. (EAST) DOYLESTOWN, PA 267-880-6321
RATHSBURG ASSOCIATES (WEST) PITTSBURGH, PA 248-615-4000

PUERTO RICO

CBX ELECTRONICS ALTAMONTE SPRINGS, FL 407-774-9100

RHODE ISLAND

CONTI-YOUNGER ASSOCIATES MARLBORO, MA 508-485-7204

SOUTH CAROLINA

CARTWRIGHT & BEAN, INC. CHARLOTTE, NC 800-242-5876

SOUTH DAKOTA

RATHSBURG ASSOCIATES BLOOMINGTON, MN 952-893-1400

TENNESSEE

CARTWRIGHT & BEAN (EAST) NORCROSS, GA 800-242-5876
CARTWRIGHT & BEAN (WEST) HUNTSVILLE, AL 800-242-5876

TEXAS

ELECTRA REPS PLANO, TX 972-599-2130
ELECTRA REPS AUSTIN 512-249-1101
ELECTRA REPS HOUSTON 281-516-1122
LUSCOMBE ENGINEERING (EL PASO) EL PASO, TX 602-678-1955

UTAH

STRAUBE ASSOCIATES ROCKY MOUNTAINS, INC. WESTMINSTER, CO 303-426-0890

VERMONT

CONTI-YOUNGER ASSOCIATES MARLBORO, MA 508-485-7204

VIRGINIA

ASTROREP MID-ATLANTIC, INC. DOYLESTOWN, PA 267-880-6321

WASHINGTON

HALBAR-RTS, INC. KIRKLAND, WA 425-893-8400

WEST VIRGINIA

RATHSBURG ASSOCIATES COLUMBUS, OH 248-615-4000

WISCONSIN

RATHSBURG ASSOCIATES MUSKEGO, WI 262-679-8250
RATHSBURG ASSOCIATES HARTFORD, WI 262-670-6513

WYOMING

STRAUBE ASSOCIATES ROCKY MOUNTAINS, INC. WESTMINSTER, CO 303-426-0890

Authorized Corcom Product Distributors and Resellers

<p>All American www.allamerican.com 1-800-573-ASAP</p>	<p>Hammond Electronics www.hammondelec.com 1-800-929-2677</p>
<p>Allied Electronics, Inc. www.alliedelec.com 1-800-433-5700</p>	<p>Heilind Electronics www.heilind.com 1-800-400-7041</p>
<p>Arrow Electronics www.arrow.com 1-800-777-2776</p>	<p>Marsh Electronics www.marshelectronics.com 1-800-236-8327</p>
<p>Avnet www.avnet.com US: 1-800-332-8638</p>	<p>Master Distributors www.masterdistributors.com 1-888-473-5297</p>
<p>Carlton Bates Company www.carlton-bates.com 1-866-600-6040</p>	<p>Mouser Electronics www.mouser.com 1-800-346-6873</p>
<p>Digi-Key Corporation www.digikey.com 1-800-344-4539</p>	<p>Newark Electronics www.newark.com 1-800-463-9275</p>
<p>Electro Sonic www.e-sonic.com 1-800-567-6642</p>	<p>Norvell Electronics www.norvell.com 1-800-893-0593</p>
<p>Future Electronics www.futureelectronics.com US & Canada: 1-800-FUTURE-1 (388-8731)</p>	<p>Sager Electronics www.sager.com 1-800-SAGER-800</p>
<p>Genie Group www.geniegroup.com 1-615-771-9412</p>	<p>Simcona Electronics www.simcona.com US: 1-800-274-6266 Canada: 1-519-652-1130</p>
<p>Gopher Electronics www.gopherelectronics.com 1-800-592-9519</p>	<p>TTI Inc. www.ttiinc.com 1-800-CALL-TTI</p>

Global Contacts

Americas

Argentina – Buenos Aires
Phone: +54-11-4733-2200
Fax: +54-11-4733-2211

Brasil – São Paulo
Phone: +55-11-2103-6000
Fax: +55-11-2103-6030

Chile – Santiago
Phone: +56-2-345-0361
Fax: +56-2-223-1477

Canada – Toronto
Phone: +905-475-6222
Fax: +905-474-5520
Product Information Center:
Phone: +905-470-4425
Fax: +905-474-5525

Colombia – Bogota
Phone: +57-1-319-8959
Fax: +57-1-319-8960

Mexico – Mexico City
Phone: +52-55-1106-0800
+01-800-733-8926
Fax: +52-55-1106-0901

**For Latin/South American
Countries not shown**
Phone: +54-11-4733-2015
Fax: +54-11-4733-2083

United States
Harrisburg, PA
Phone: +1-717-564-0100
Fax: +1-717-986-7575
Product Information Center:
Phone: +1-800-522-6752
Fax: +1-717-986-7575
Mundelein, IL
Phone: +1-847-680-7400
Fax: +1-847-680-8169

Asia/Pacific

Australia – Sydney
Phone: +61-2-9554-2600
Fax: +61-2-9502-2556
Product Information Center:
Phone: +61-2-9840-8200
Fax: +61-2-9634-6188

India – Bangalore
Phone: +91-80-285-40800
Fax: +91-80-285-40820

Indonesia – Jakarta
Phone: +65-6482-0311
Fax: +65-6482-1012

Japan – Kawasaki, Kanagawa
Phone: +81-44-844-8111
Fax: +81-44-812-3207
Product Information Center:
Phone: +81-44-844-8013
Fax: +81-44-812-3200

Korea – Seoul
Phone: +82-2-3415-4500
Fax: +82-2-3486-3810

Malaysia – Selangor
Phone: +60-3-7805-3055
Fax: +60-3-7805-3066

New Zealand – Auckland
Phone: +64-9-634-4580
Fax: +64-9-634-4586

Philippines – Makati City
Phone: +632-848-0171
Fax: +632-867-8661

People's Republic of China
Hong Kong
Phone: +852-2735-1628
Fax: +852-2735-0243
Shanghai
Phone: +86-21-2407-1588
Fax: +86-21-2407-1599

Singapore – Singapore
Phone: +65-6482-0311
Fax: +65-6482-1012

Taiwan – Taipei
Phone: +886-2-8768-2788
Fax: +886-2-8768-2268

Thailand – Bangkok
Phone: +66-2-955-0500
Fax: +66-2-955-0505

Vietnam – Ho Chi Minh City
Phone: +84-8-930-5546
Fax: +84-8-930-3443

Europe/Middle East/Africa

Austria – Vienna
Phone: +43-1-905-60-0
Fax: +43-1-905-60-1333
Product Information Center:
Phone: +43-1-905-60-1228
Fax: +43-1-905-60-1333

Belarus – Minsk
Phone: +375 17 237 47 94
Fax: +375 17 237 47 94

Belgium – Kessel-Lo
Phone: +32-16-352-300
Fax: +32-16-352-355

Bulgaria – Sofia
Phone: +359-2-971-2152
Fax: +359-2-971-2153

Czech Republic and Slovakia
Czech Republic – Kurim
Phone: +420-541-162-111
Fax: +420-541-162-223
Product Information Center:
Phone: +420-541-162-113
Fax: +420-541-162-104

Denmark – Glostrup
Phone: +45-43-48-04-00
Fax: +45-43-44-14-14

Egypt – Cairo
Phone: +202-419-2334
Fax: +202-417-7647

Estonia – Tartu
Phone: +372-5138-274
Fax: +372-7400-779

Finland – Helsinki
Phone: +358-95-12-34-20
Fax: +358-95-12-34-250

France – Cergy-Pontoise Cedex
Phone: +33-1-3420-8888
Fax: +33-1-3420-8600
Product Information Center:
Phone: +33-1-3420-8686
Fax: +33-1-3420-8623

France Export Divisions –
Cergy-Pontoise Cedex
Phone: +33-1-3420-8804
Fax: +33-1-3420-8699

Germany – Bensheim
Phone: +49-6251-133-0
Fax: +49-6251-133-1600
Product Information Center:
Phone: +49-6251-133-1999
Fax: +49-6251-133-1988

Greece – Athens
Phone: +30-210-9370-
396/397
Fax: +30-210-9370-655

Hungary – Budapest
Phone: +36-1-289-1000
Fax: +36-1-289-1010
Product Information Center:
Phone: +36-1-289-1016
Fax: +36-1-289-1017

Ireland – Dublin
Phone: +353-1-866-5612
Fax: +353-1-866-5714

Israel – Petach-Tikva
Phone: +972-3-929-0999
Fax: +972-3-919-1088

Italy – Collegno (Torino)
Phone: +39-011-4012-111
Fax: +39-011-4031-116
Product Information Center:
Phone: +39-011-4012-632
Fax: +39-011-40-287-632

Lithuania and Latvia
Lithuania – Vilnius
Phone: +370-5-213-1402
Fax: +370-5-213-1403
Product Information Center:
Phone: +370-5-211-3016
Fax: +370-5-213-1403

Netherlands –
's-Hertogenbosch
Phone: +31-73-6246-246
Fax: +31-73-6212-365
Product Information Center:
Phone: +31-73-6246-999
Fax: +31-73-6246-998

Norway – Nesbru
Phone: +47-66-77-88-50
Fax: +47-66-77-88-55

Poland – Warsaw
Phone: +48-22-4576-700
Fax: +48-22-4576-720
Product Information Center:
Phone: +48-22-4576-704
Fax: +48-22-4576-720

Romania – Bucharest
Phone: +40-21-311-3479/3596
Fax: +40-21-312-0574
Russia – Moscow
Phone: +7-495-790-7902
Fax: +7-495-721-1893
Product Information Center:
Phone: +7-495-790-7902-404
Fax: +7-495-790-7902-401

Russia – St. Petersburg
Phone: +7-812-718-8192
Fax: +7-812-718-8193

Slovenia – Ljubljana
Phone: +386-1561-3270
Fax: +386-1561-3240

South Africa – Port Elizabeth
Phone: +27-41-503-4500
Fax: +27-41-581-0440

Spain – Barcelona
Phone: +34-93-291-0330
Fax: +34-93-201-7879

Sweden – Upplands Väsby
Phone: +46-8-50-72-50-00
Fax: +46-8-50-72-50-01

Switzerland – Steinach
Phone: +41-71-447-0447
Fax: +41-71-447-0444

Turkey – Istanbul
Phone: +90-212-281-8181/2/3
+90-212-282-
5130/5430
Fax: +90-212-281-8184

Ukraine – Kiev
Phone: +380-44-206-2265
Fax: +380-44-206-2264
Product Information Center:
Phone: +380-44-206-2265
Fax: +380-44-206-2264

United Kingdom –
Stanmore, Middlesex
Phone: +44-8706-080208
Fax: +44-208-954-6234
Product Information Center:
Freephone (UK only):
+0800-267-666
Phone: +44-8706-080208
Fax: +44-208-420-8095

FOR MORE INFORMATION

te.com/industry/commercial-building-technology
corcom.com

TE Technical Support Center

Internet:	te.com/help
USA:	+1 (800) 522-6752
Canada:	+1 (905) 475-6222
Mexico:	+52 (0) 55-1106-0800
Latin/S. America:	+54 (0) 11-4733-2200
Germany:	+49 (0) 6251-133-1999
UK:	+44 (0) 800-267666
France:	+33 (0) 1-3420-8686
Netherlands:	+31 (0) 73-6246-999
China:	+86 (0) 400-820-6015

Part numbers in this brochure are RoHS Compliant*, unless marked otherwise.

*as defined www.te.com/leadfree

te.com
corcom.com

© 2011 Tyco Electronics Corporation, a TE Connectivity Ltd. company. All Rights Reserved.
1654001 CIS JG 06/2011

Corcom, TE Connectivity, TE connectivity (logo) and TE (logo) are trademarks. Other logos, product and/or company names might be trademarks of their respective owners.

While TE has made every reasonable effort to ensure the accuracy of the information in this brochure, TE does not guarantee that it is error-free, nor does TE make any other representation, warranty or guarantee that the information is accurate, correct, reliable or current. TE reserves the right to make any adjustments to the information contained herein at any time without notice. TE expressly disclaims all implied warranties regarding the information contained herein, including, but not limited to, any implied warranties of merchantability or fitness for a particular purpose. The dimensions in this catalog are for reference purposes only and are subject to change without notice. Specifications are subject to change without notice. Consult TE for the latest dimensions and design specifications.



Компания «Океан Электроники» предлагает заключение долгосрочных отношений при поставках импортных электронных компонентов на взаимовыгодных условиях!

Наши преимущества:

- Поставка оригинальных импортных электронных компонентов напрямую с производств Америки, Европы и Азии, а так же с крупнейших складов мира;
- Широкая линейка поставок активных и пассивных импортных электронных компонентов (более 30 млн. наименований);
- Поставка сложных, дефицитных, либо снятых с производства позиций;
- Оперативные сроки поставки под заказ (от 5 рабочих дней);
- Экспресс доставка в любую точку России;
- Помощь Конструкторского Отдела и консультации квалифицированных инженеров;
- Техническая поддержка проекта, помощь в подборе аналогов, поставка прототипов;
- Поставка электронных компонентов под контролем ВП;
- Система менеджмента качества сертифицирована по Международному стандарту ISO 9001;
- При необходимости вся продукция военного и аэрокосмического назначения проходит испытания и сертификацию в лаборатории (по согласованию с заказчиком);
- Поставка специализированных компонентов военного и аэрокосмического уровня качества (Xilinx, Altera, Analog Devices, Intersil, Interpoint, Microsemi, Actel, Aeroflex, Peregrine, VPT, Syfer, Eurofarad, Texas Instruments, MS Kennedy, Miteq, Cobham, E2V, MA-COM, Hittite, Mini-Circuits, General Dynamics и др.);

Компания «Океан Электроники» является официальным дистрибьютором и эксклюзивным представителем в России одного из крупнейших производителей разъемов военного и аэрокосмического назначения «JONHON», а так же официальным дистрибьютором и эксклюзивным представителем в России производителя высокотехнологичных и надежных решений для передачи СВЧ сигналов «FORSTAR».



JONHON

«JONHON» (основан в 1970 г.)

Разъемы специального, военного и аэрокосмического назначения:

(Применяются в военной, авиационной, аэрокосмической, морской, железнодорожной, горно- и нефтедобывающей отраслях промышленности)

«FORSTAR» (основан в 1998 г.)

ВЧ соединители, коаксиальные кабели, кабельные сборки и микроволновые компоненты:

(Применяются в телекоммуникациях гражданского и специального назначения, в средствах связи, РЛС, а так же военной, авиационной и аэрокосмической отраслях промышленности).



Телефон: 8 (812) 309-75-97 (многоканальный)

Факс: 8 (812) 320-03-32

Электронная почта: ocean@oceanchips.ru

Web: <http://oceanchips.ru/>

Адрес: 198099, г. Санкт-Петербург, ул. Калинина, д. 2, корп. 4, лит. А