

# MMBTA13L, SMMBTA13L, MMBTA14L, SMMBTA14L

## Darlington Amplifier Transistors

### NPN Silicon

#### Features

- S Prefix for Automotive and Other Applications Requiring Unique Site and Control Change Requirements; AEC-Q101 Qualified and PPAP Capable
- These Devices are Pb-Free, Halogen Free/BFR Free and are RoHS Compliant\*

#### MAXIMUM RATINGS

Rating	Symbol	Value	Unit
Collector - Emitter Voltage	$V_{CES}$	30	Vdc
Collector - Base Voltage	$V_{CBO}$	30	Vdc
Emitter - Base Voltage	$V_{EBO}$	10	Vdc
Collector Current - Continuous	$I_C$	300	mA

#### THERMAL CHARACTERISTICS

Characteristic	Symbol	Max	Unit
Total Device Dissipation FR-5 Board (Note 1) $T_A = 25^\circ\text{C}$ Derate above $25^\circ\text{C}$	$P_D$	225 1.8	mW mW/ $^\circ\text{C}$
Thermal Resistance, Junction-to-Ambient	$R_{\theta JA}$	556	$^\circ\text{C}/\text{W}$
Total Device Dissipation Alumina Substrate, (Note 2) $T_A = 25^\circ\text{C}$ Derate above $25^\circ\text{C}$	$P_D$	300 2.4	mW mW/ $^\circ\text{C}$
Thermal Resistance, Junction-to-Ambient	$R_{\theta JA}$	417	$^\circ\text{C}/\text{W}$
Junction and Storage Temperature	$T_J, T_{stg}$	-55 to +150	$^\circ\text{C}$

Stresses exceeding Maximum Ratings may damage the device. Maximum Ratings are stress ratings only. Functional operation above the Recommended Operating Conditions is not implied. Extended exposure to stresses above the Recommended Operating Conditions may affect device reliability.

1. FR-5 =  $1.0 \times 0.75 \times 0.062$  in.
2. Alumina =  $0.4 \times 0.3 \times 0.024$  in. 99.5% alumina.

\*For additional information on our Pb-Free strategy and soldering details, please download the ON Semiconductor Soldering and Mounting Techniques Reference Manual, SOLDERRM/D.



ON Semiconductor®

<http://onsemi.com>

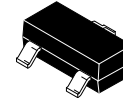

SOT-23 (TO-236)  
CASE 318  
STYLE 6

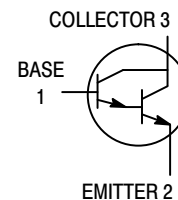

#### MARKING DIAGRAM

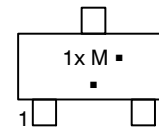

- 1x = Device Code  
 x = M for MMBTA13LT1G,  
 SMMBTA13LT1G  
 x = N for MMBTA14LT1G,  
 SMMBTA14LT1G, T3G  
 M = Date Code\*  
 ■ = Pb-Free Package

(Note: Microdot may be in either location)

\*Date Code orientation and/or overbar may vary depending upon manufacturing location.

#### ORDERING INFORMATION

Device	Package	Shipping†
MMBTA13LT1G, SMMBTA13LT1G	SOT-23 (Pb-Free)	3,000 / Tape & Reel
MMBTA14LT1G, SMMBTA14LT1G	SOT-23 (Pb-Free)	3,000 / Tape & Reel
SMMBTA14LT3G	SOT-23 (Pb-Free)	10,000 / Tape & Reel

†For information on tape and reel specifications, including part orientation and tape sizes, please refer to our Tape and Reel Packaging Specifications Brochure, BRD8011/D.

# MMBTA13L, SMMBTA13L, MMBTA14L, SMMBTA14L

## ELECTRICAL CHARACTERISTICS ( $T_A = 25^\circ\text{C}$ unless otherwise noted)

Characteristic	Symbol	Min	Max	Unit
<b>OFF CHARACTERISTICS</b>				
Collector – Emitter Breakdown Voltage ( $I_C = 100 \mu\text{Adc}$ , $V_{BE} = 0$ )	$V_{(BR)CES}$	30	–	Vdc
Collector Cutoff Current ( $V_{CB} = 30 \text{ Vdc}$ , $I_E = 0$ )	$I_{CBO}$	–	100	nAdc
Emitter Cutoff Current ( $V_{EB} = 10 \text{ Vdc}$ , $I_C = 0$ )	$I_{EBO}$	–	100	nAdc

## ON CHARACTERISTICS (Note 3)

DC Current Gain ( $I_C = 10 \text{ mAdc}$ , $V_{CE} = 5.0 \text{ Vdc}$ ) MMBTA13, SMMBTA13 MMBTA14, SMMBTA14 ( $I_C = 100 \text{ mAdc}$ , $V_{CE} = 5.0 \text{ Vdc}$ ) MMBTA13, SMMBTA13 MMBTA14, SMMBTA14	$h_{FE}$	5000 10,000 10,000 20,000	– – – –	–
Collector – Emitter Saturation Voltage ( $I_C = 100 \text{ mAdc}$ , $I_B = 0.1 \text{ mAdc}$ )	$V_{CE(sat)}$	–	1.5	Vdc
Base – Emitter On Voltage ( $I_C = 100 \text{ mAdc}$ , $V_{CE} = 5.0 \text{ Vdc}$ )	$V_{BE}$	–	2.0	Vdc

## SMALL-SIGNAL CHARACTERISTICS

Current – Gain – Bandwidth Product (Note 4) ( $I_C = 10 \text{ mAdc}$ , $V_{CE} = 5.0 \text{ Vdc}$ , $f = 100 \text{ MHz}$ )	$f_T$	125	–	MHz
---	-------	-----	---	-----

3. Pulse Test: Pulse Width  $\leq 300 \mu\text{s}$ , Duty Cycle  $\leq 2.0\%$ .

4.  $f_T = |h_{fe}| \cdot f_{test}$ .



Figure 1. Transistor Noise Model

# MMBTA13L, SMMBTA13L, MMBTA14L, SMMBTA14L

## NOISE CHARACTERISTICS

( $V_{CE} = 5.0 \text{ Vdc}$ ,  $T_A = 25^\circ\text{C}$ )



Figure 2. Noise Voltage

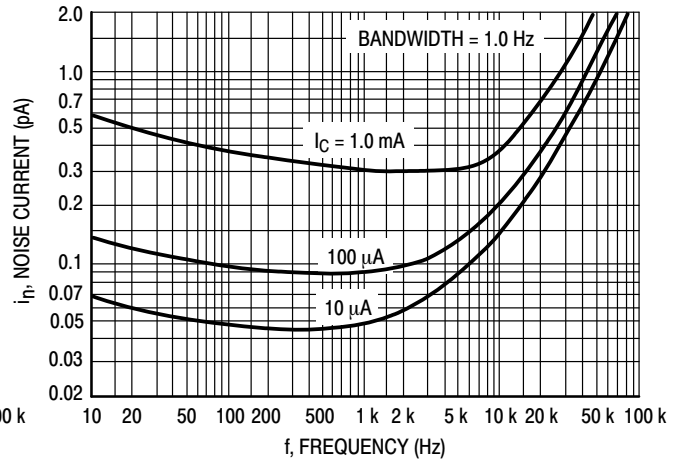

Figure 3. Noise Current

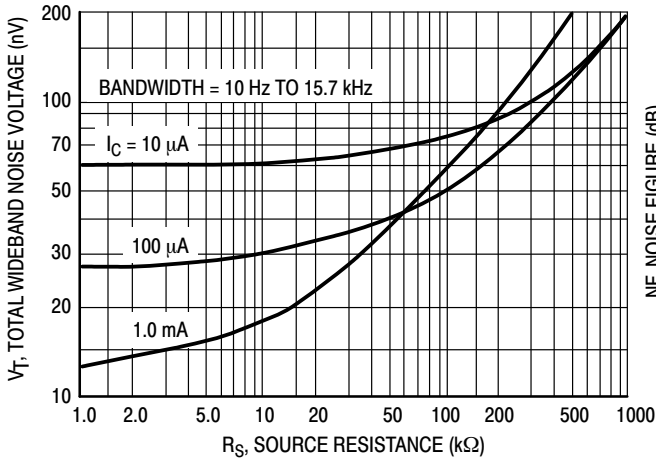

Figure 4. Total Wideband Noise Voltage

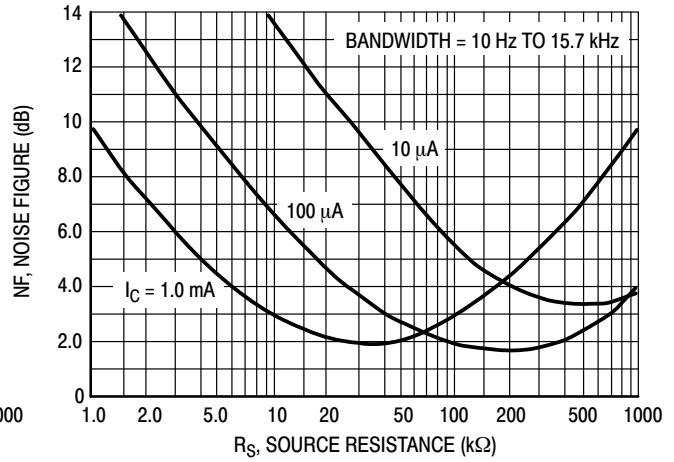

Figure 5. Wideband Noise Figure

SMALL-SIGNAL CHARACTERISTICS

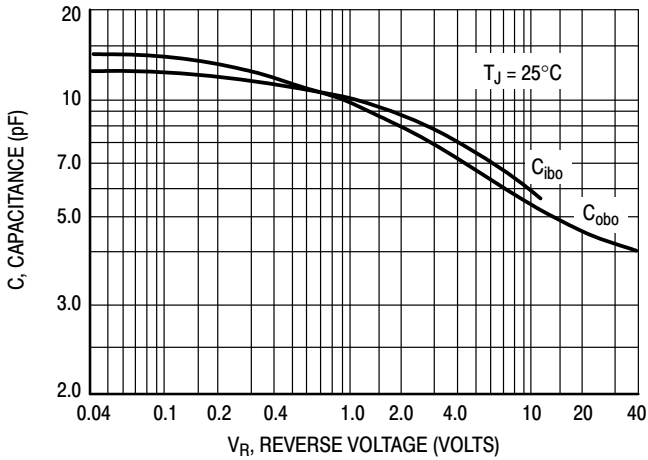

Figure 6. Capacitance

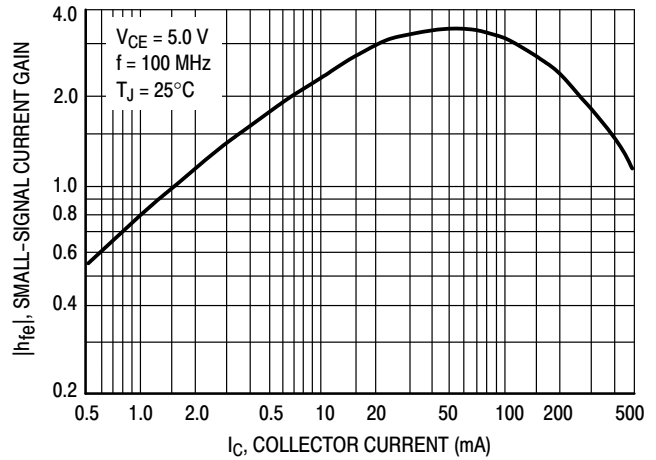

Figure 7. High Frequency Current Gain

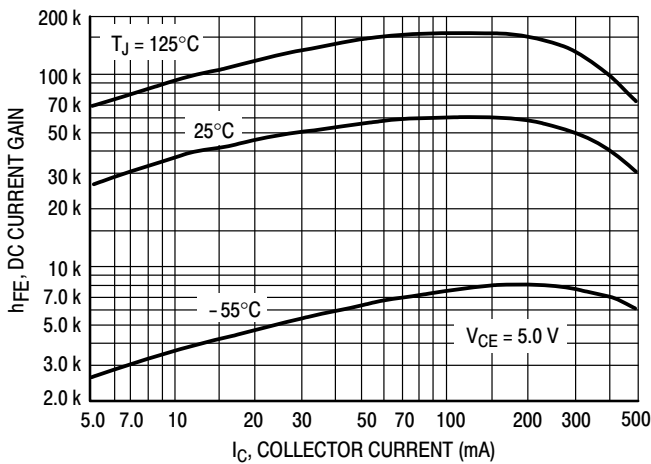

Figure 8. DC Current Gain

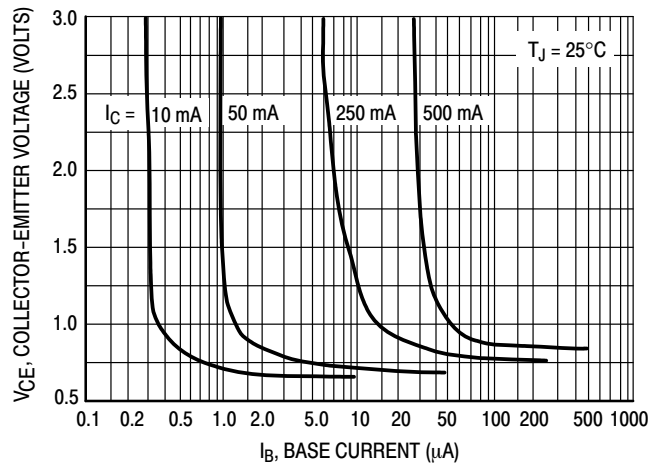

Figure 9. Collector Saturation Region

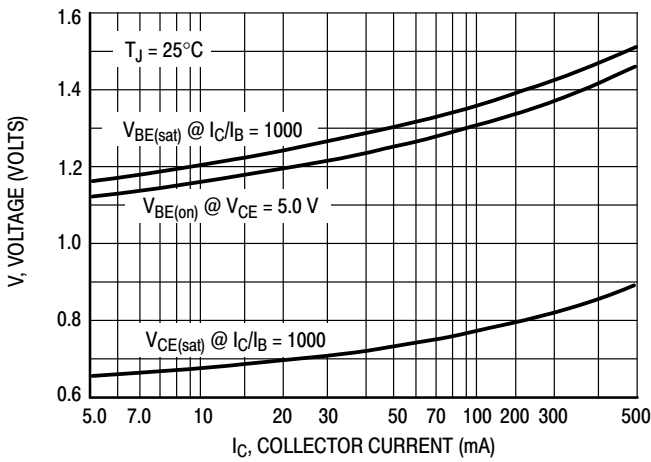

Figure 10. "On" Voltages

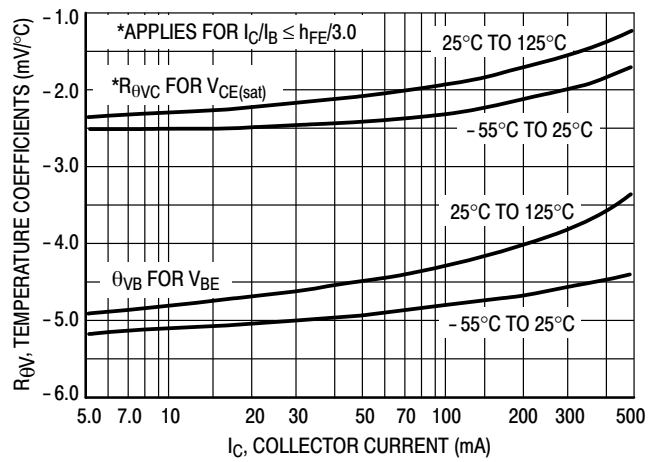

Figure 11. Temperature Coefficients

MMBTA13L, SMMBTA13L, MMBTA14L, SMMBTA14L



Figure 12. Thermal Response



Figure 13. Active Region Safe Operating Area



Design Note: Use of Transient Thermal Resistance Data

# MMBTA13L, SMMBTA13L, MMBTA14L, SMMBTA14L

## PACKAGE DIMENSIONS

SOT-23 (TO-236)  
CASE 318-08  
ISSUE AP

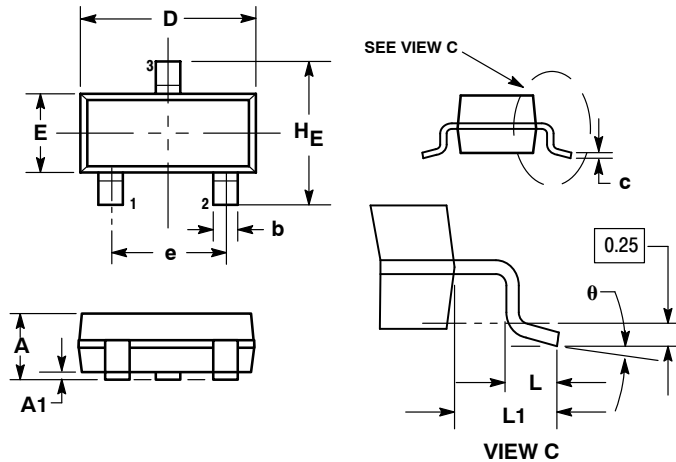

NOTES:

1. DIMENSIONING AND TOLERANCING PER ANSI Y14.5M, 1982.
2. CONTROLLING DIMENSION: INCH.
3. MAXIMUM LEAD THICKNESS INCLUDES LEAD FINISH THICKNESS. MINIMUM LEAD THICKNESS IS THE MINIMUM THICKNESS OF BASE MATERIAL.
4. DIMENSIONS D AND E DO NOT INCLUDE MOLD FLASH, PROTRUSIONS, OR GATE BURRS.

DIM	MILLIMETERS			INCHES		
	MIN	NOM	MAX	MIN	NOM	MAX
A	0.89	1.00	1.11	0.035	0.040	0.044
A1	0.01	0.06	0.10	0.001	0.002	0.004
b	0.37	0.44	0.50	0.015	0.018	0.020
c	0.09	0.13	0.18	0.003	0.005	0.007
D	2.80	2.90	3.04	0.110	0.114	0.120
E	1.20	1.30	1.40	0.047	0.051	0.055
e	1.78	1.90	2.04	0.070	0.075	0.081
L	0.10	0.20	0.30	0.004	0.008	0.012
L1	0.35	0.54	0.69	0.014	0.021	0.029
HE	2.10	2.40	2.64	0.083	0.094	0.104
θ	0°	---	10°	0°	---	10°

STYLE 6:

1. BASE
2. EMITTER
3. COLLECTOR

### SOLDERING FOOTPRINT\*



\*For additional information on our Pb-Free strategy and soldering details, please download the ON Semiconductor Soldering and Mounting Techniques Reference Manual, SOLDERRM/D.

ON Semiconductor and are registered trademarks of Semiconductor Components Industries, LLC (SCILLC). SCILLC reserves the right to make changes without further notice to any products herein. SCILLC makes no warranty, representation or guarantee regarding the suitability of its products for any particular purpose, nor does SCILLC assume any liability arising out of the application or use of any product or circuit, and specifically disclaims any and all liability, including without limitation special, consequential or incidental damages. "Typical" parameters which may be provided in SCILLC data sheets and/or specifications can and do vary in different applications and actual performance may vary over time. All operating parameters, including "Typicals" must be validated for each customer application by customer's technical experts. SCILLC does not convey any license under its patent rights nor the rights of others. SCILLC products are not designed, intended, or authorized for use as components in systems intended for surgical implant into the body, or other applications intended to support or sustain life, or for any other application in which the failure of the SCILLC product could create a situation where personal injury or death may occur. Should Buyer purchase or use SCILLC products for any such unintended or unauthorized application, Buyer shall indemnify and hold SCILLC and its officers, employees, subsidiaries, affiliates, and distributors harmless against all claims, costs, damages, and expenses, and reasonable attorney fees arising out of, directly or indirectly, any claim of personal injury or death associated with such unintended or unauthorized use, even if such claim alleges that SCILLC was negligent regarding the design or manufacture of the part. SCILLC is an Equal Opportunity/Affirmative Action Employer. This literature is subject to all applicable copyright laws and is not for resale in any manner.

### PUBLICATION ORDERING INFORMATION

**LITERATURE FULFILLMENT:**  
Literature Distribution Center for ON Semiconductor  
P.O. Box 5163, Denver, Colorado 80217 USA  
**Phone:** 303-675-2175 or 800-344-3860 Toll Free USA/Canada  
**Fax:** 303-675-2176 or 800-344-3867 Toll Free USA/Canada  
**Email:** orderlit@onsemi.com

**N. American Technical Support:** 800-282-9855 Toll Free USA/Canada  
**Europe, Middle East and Africa Technical Support:**  
Phone: 421 33 790 2910  
**Japan Customer Focus Center**  
Phone: 81-3-5817-1050

**ON Semiconductor Website:** [www.onsemi.com](http://www.onsemi.com)

**Order Literature:** <http://www.onsemi.com/orderlit>

For additional information, please contact your local Sales Representative

Компания «Океан Электроники» предлагает заключение долгосрочных отношений при поставках импортных электронных компонентов на взаимовыгодных условиях!

Наши преимущества:

- Поставка оригинальных импортных электронных компонентов напрямую с производств Америки, Европы и Азии, а так же с крупнейших складов мира;
- Широкая линейка поставок активных и пассивных импортных электронных компонентов (более 30 млн. наименований);
- Поставка сложных, дефицитных, либо снятых с производства позиций;
- Оперативные сроки поставки под заказ (от 5 рабочих дней);
- Экспресс доставка в любую точку России;
- Помощь Конструкторского Отдела и консультации квалифицированных инженеров;
- Техническая поддержка проекта, помощь в подборе аналогов, поставка прототипов;
- Поставка электронных компонентов под контролем ВП;
- Система менеджмента качества сертифицирована по Международному стандарту ISO 9001;
- При необходимости вся продукция военного и аэрокосмического назначения проходит испытания и сертификацию в лаборатории (по согласованию с заказчиком);
- Поставка специализированных компонентов военного и аэрокосмического уровня качества (Xilinx, Altera, Analog Devices, Intersil, Interpoint, Microsemi, Actel, Aeroflex, Peregrine, VPT, Syfer, Eurofarad, Texas Instruments, MS Kennedy, Miteq, Cobham, E2V, MA-COM, Hittite, Mini-Circuits, General Dynamics и др.);

Компания «Океан Электроники» является официальным дистрибьютором и эксклюзивным представителем в России одного из крупнейших производителей разъемов военного и аэрокосмического назначения «JONHON», а так же официальным дистрибьютором и эксклюзивным представителем в России производителя высокотехнологичных и надежных решений для передачи СВЧ сигналов «FORSTAR».



## JONHON

«JONHON» (основан в 1970 г.)

Разъемы специального, военного и аэрокосмического назначения:

(Применяются в военной, авиационной, аэрокосмической, морской, железнодорожной, горно- и нефтедобывающей отраслях промышленности)

«FORSTAR» (основан в 1998 г.)

ВЧ соединители, коаксиальные кабели, кабельные сборки и микроволновые компоненты:

(Применяются в телекоммуникациях гражданского и специального назначения, в средствах связи, РЛС, а так же военной, авиационной и аэрокосмической отраслях промышленности).



Телефон: 8 (812) 309-75-97 (многоканальный)

Факс: 8 (812) 320-03-32

Электронная почта: [ocean@oceanchips.ru](mailto:ocean@oceanchips.ru)

Web: <http://oceanchips.ru/>

Адрес: 198099, г. Санкт-Петербург, ул. Калинина, д. 2, корп. 4, лит. А