

Double-Balanced Mixer 8 to 43 GHz

Rev. V1

Features

- Low Conversion Loss: 8 dB
- High Linearity: 22 dBm IIP3
- Wide IF Bandwidth: DC to 10 GHz
- High Isolation
- Die Size: 1.20 × 0.97 × 0.10 mm
- RoHS* Compliant

Description

MAMX-011036-DIE is a double-balanced passive diode mixer MMIC. The mixer offers low conversion loss, high linearity and a wide IF bandwidth. The double-balanced circuit configuration provides excellent port isolation while internal 50-ohm matching simplifies its application.

This mixer is well suited for applications such as test and measurement, microwave radio and radar.

MAMX-011036-DIE is also available in a 3 mm QFN package. Refer to datasheet MAMX-011036.

Ordering Information

| Part Number | Package |
|-----------------|--------------------------------------|
| MAMX-011036-DIE | Vacuum Release Gel Pack ¹ |
| MAMX-011036-SB2 | Sample Board |

1. Die quantity varies.

Functional Schematic

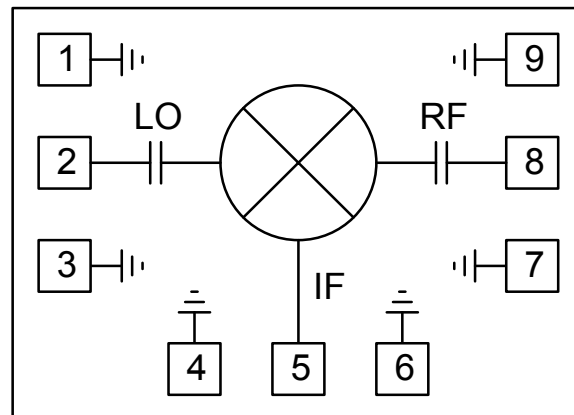

Bond-pad Configuration

| Pad No. | Function | Pad No. | Function |
|---------|------------------|---------|------------------|
| 1 | GND ² | 6 | GND ² |
| 2 | LO | 7 | GND ² |
| 3 | GND ² | 8 | RF |
| 4 | GND ² | 9 | GND ² |
| 5 | IF | 10 | GND ³ |

2. These pads are internally connected to ground, and they can be left unconnected.
3. The backside of the die must be connected to RF, DC and thermal ground.

* Restrictions on Hazardous Substances, European Union Directive 2011/65/EU.

Double-Balanced Mixer 8 to 43 GHz

Rev. V1

Electrical Specifications⁴: $F_{IF} = 500 \text{ MHz}$, $P_{LO} = +15 \text{ dBm}$, $T_A = 25^\circ\text{C}$, $Z_0 = 50 \Omega$

| Parameter | Test Conditions | Units | Min. | Typ. | Max. |
|---------------------|--|-------|----------------|----------------|----------------|
| LO and RF Frequency | — | GHz | 8 | — | 43 |
| IF Frequency | — | GHz | 0 | — | 10 |
| LO Power | — | dBm | — | 15 | — |
| Conversion Loss | 8 - 20 GHz 20 - 34 GHz 34 - 43 GHz | dB | — | 8 8 9 | 10 11 13 |
| Input P1dB | — | dBm | — | 13 | — |
| Input IP3 | $P_{RF} = -10 \text{ dBm/tone}$, $\Delta f = 1 \text{ MHz}$ | dBm | — | 22 | — |
| Input IP2 | $P_{RF} = -10 \text{ dBm/tone}$, $\Delta f = 1 \text{ MHz}$ | dBm | — | 45 | — |
| LO-to-RF Isolation | — | dB | — | 40 | — |
| LO-to-IF Isolation | 8 - 20 GHz 20 - 34 GHz 34 - 43 GHz | dB | 26 14 20 | 40 33 50 | — |
| RF-to-IF Isolation | 8 - 20 GHz 20 - 34 GHz 34 - 43 GHz | dB | - - 23 | 9 25 38 | — |
| RF Return Loss | RF = 15 GHz | dB | — | 5 | — |
| IF Return Loss | IF = 500 MHz | dB | — | 15 | — |

4. All specifications refer to down-conversion operation, unless otherwise noted.

Absolute Maximum Ratings^{5,6}

| Parameter | Absolute Maximum |
|-----------------------------------|------------------|
| LO Power | 23 dBm |
| RF or IF Power | 20 dBm |
| Junction Temperature ⁷ | +150°C |
| Operating Temperature | -55°C to +85°C |
| Storage Temperature | -65°C to +150°C |

- Exceeding any one or combination of these limits may cause permanent damage to this device.
- MACOM does not recommend sustained operation near these survivability limits.
- Operating at nominal conditions with $T_J \leq +150^\circ\text{C}$ will ensure $\text{MTTF} > 1 \times 10^6$ hours.

Handling Procedures

Please observe the following precautions to avoid damage:

Static Sensitivity

These electronic devices are sensitive to electrostatic discharge (ESD) and can be damaged by static electricity. Proper ESD control techniques should be used when handling these HBM Class 1B devices.

Double-Balanced Mixer 8 to 43 GHz

Rev. V1

Typical Performance Curves, $P_{LO} = +15 \text{ dBm}$, $T_A = 25^\circ\text{C}$

IF Bandwidth & Return Loss

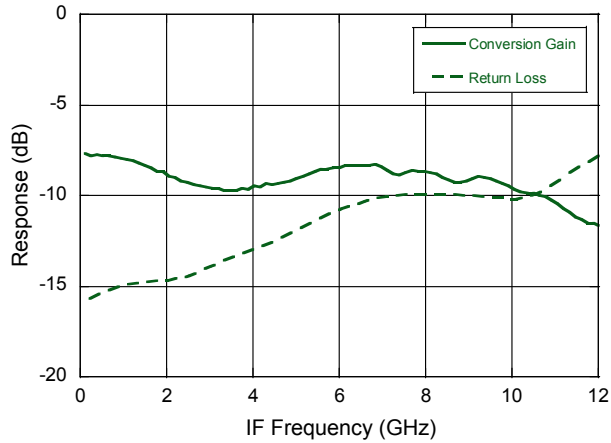

Isolation

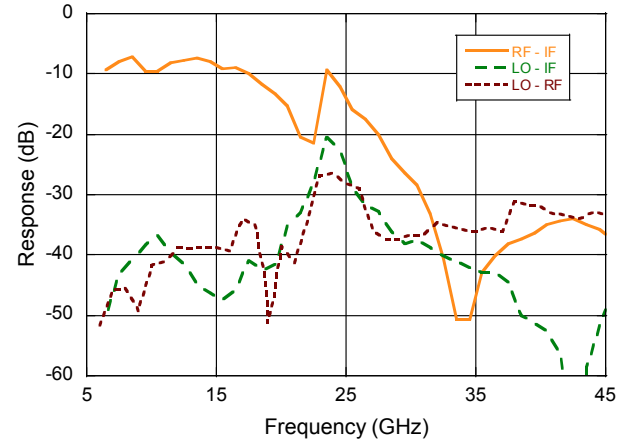

RF Return Loss

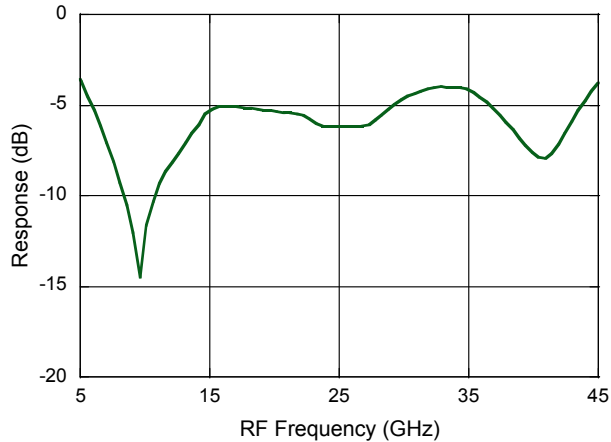

Double-Balanced Mixer 8 to 43 GHz

Rev. V1

Typical Performance Curves vs. LO Power, $T_A = 25^\circ\text{C}$

Conversion Gain

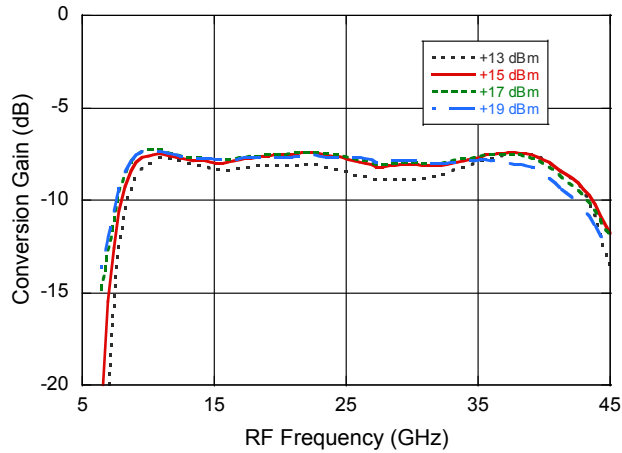

Input P1dB

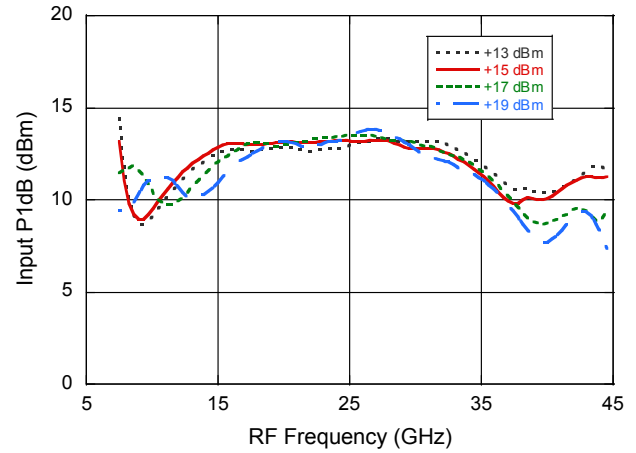

Input IP3 at $P_{LO} = +15\text{ dBm}$

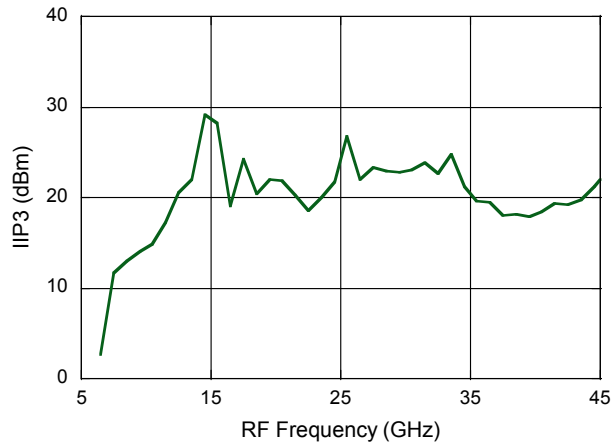

Input IP2 at $P_{LO} = +15\text{ dBm}$

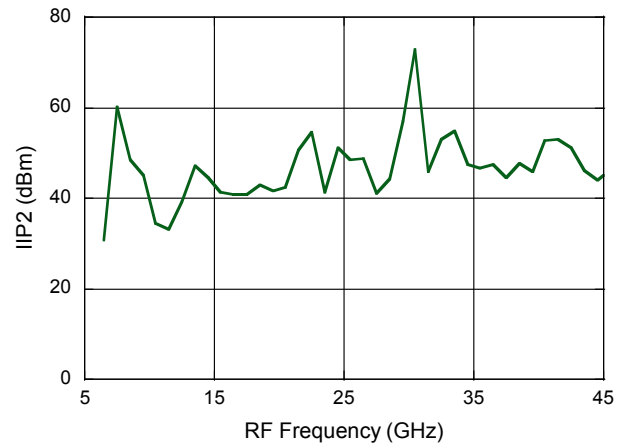

Up Conversion Gain

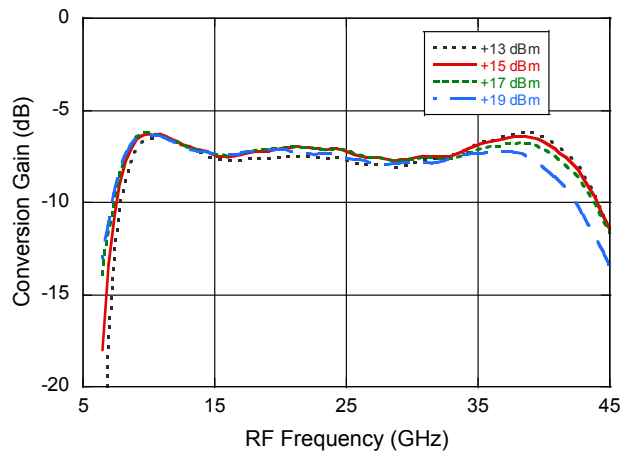

All performance curves refer to down-conversion operation, unless otherwise noted.
Two-tone input power = -10 dBm each tone, 1 MHz spacing.

Typical Performance Curves vs. Temperature, $P_{LO} = +15$ dBm

Conversion Gain

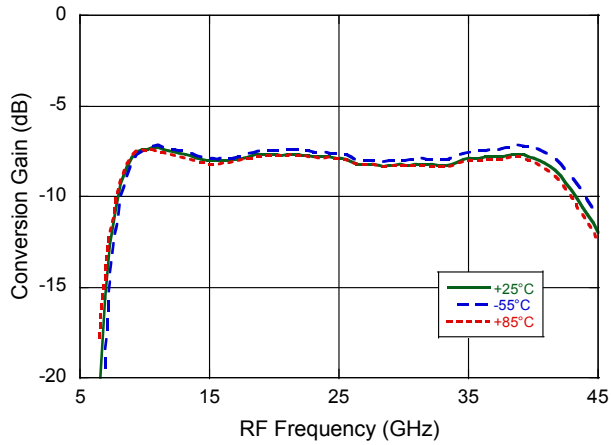

Input IP3

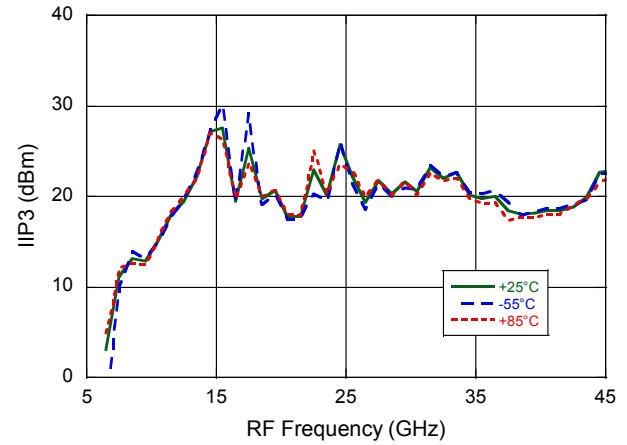

Input IP2

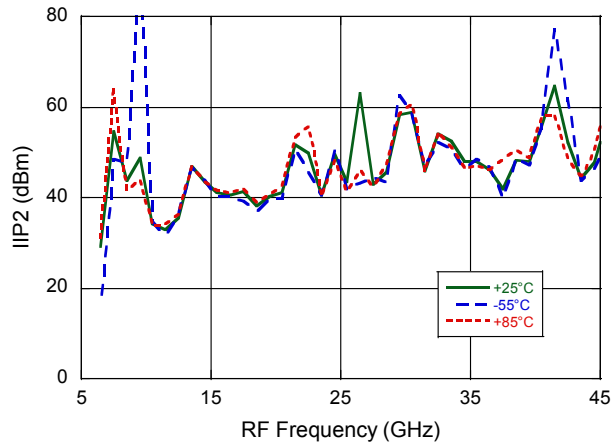

All performance curves refer to down-conversion operation, unless otherwise noted.
Two-tone input power = -10 dBm each tone, 1 MHz spacing.

MxN Spurious Rejection @ IF Port (dBc IF)

RF = 17.5 GHz @ -10 dBm

LO = 18.0 GHz @ +15 dBm

| MxRF | NxLO | | | | |
|------|------|----|----|-----|-----|
| | 0 | 1 | 2 | 3 | 4 |
| 0 | x | 11 | 40 | x | x |
| 1 | 2 | 0 | 28 | 42 | x |
| 2 | 77 | 65 | 52 | 65 | 80 |
| 3 | x | 90 | 73 | 76 | 77 |
| 4 | x | x | 95 | 104 | 104 |

Assembly Guideline

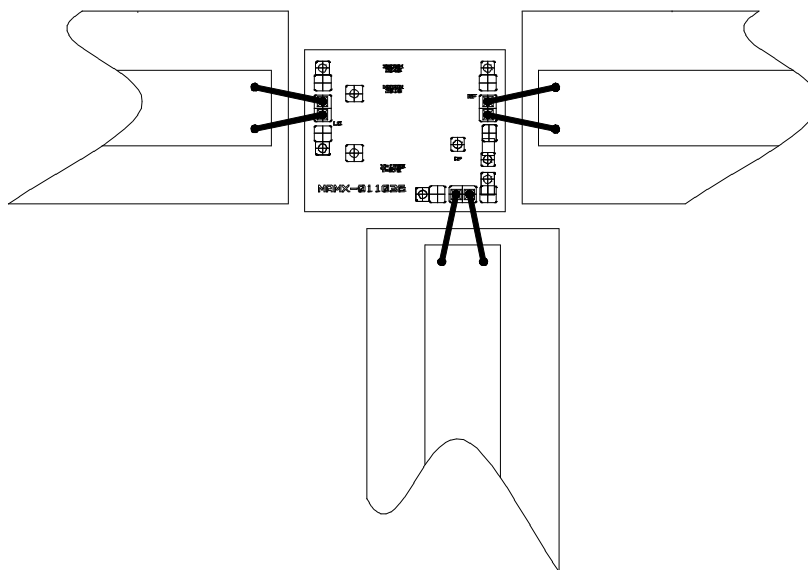

Notes:

Attach bare die to PCB or carrier using conductive epoxy. Bond die signal pads to PCB 50 Ω traces using 1.0 mil gold wire. Two bond wires are recommended on each signal pad for optimal performance. There is no need to bond the die GND pads.

MAMX-011036-DIE



Double-Balanced Mixer
8 to 43 GHz

Rev. V1

Outline Drawing

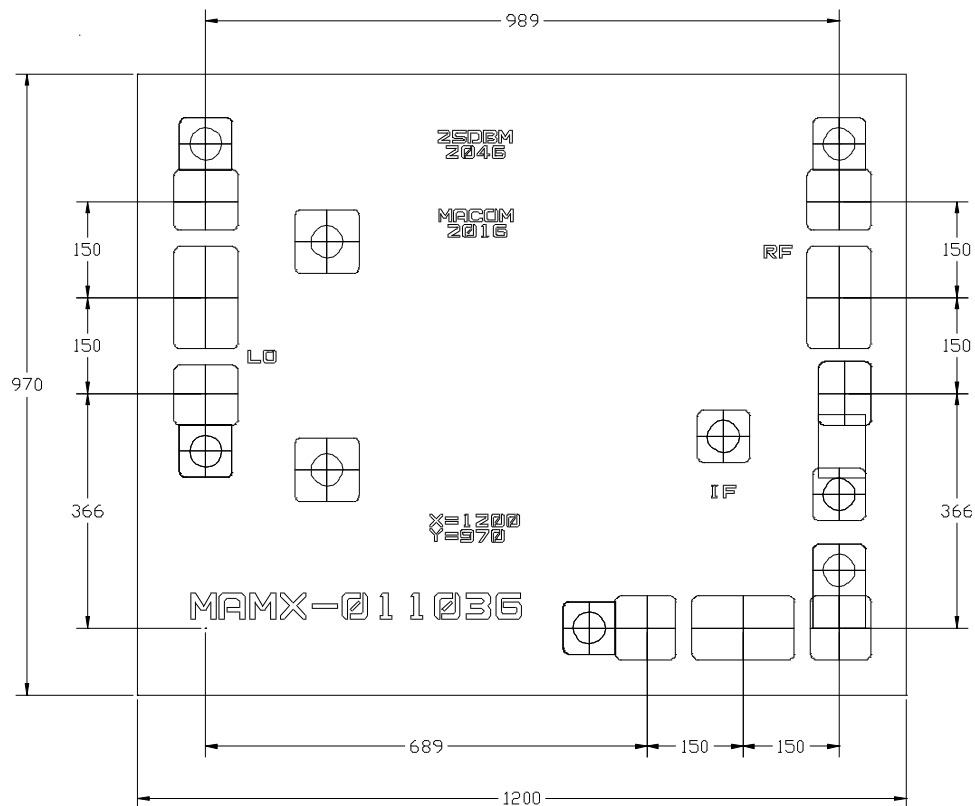

Notes:

Units are in microns with a tolerance of $\pm 5 \mu\text{m}$, except for die exterior dimensions which are street-center-to-street-center – nominal kerf, $\pm 20 \mu\text{m}$ tolerance.

Die thickness is $100 \pm 10 \mu\text{m}$.

RF, LO and IF Bond-pads are $160 \times 100 \mu\text{m}$.

MACOM Technology Solutions Inc. All rights reserved.

Information in this document is provided in connection with MACOM Technology Solutions Inc ("MACOM") products. These materials are provided by MACOM as a service to its customers and may be used for informational purposes only. Except as provided in MACOM's Terms and Conditions of Sale for such products or in any separate agreement related to this document, MACOM assumes no liability whatsoever. MACOM assumes no responsibility for errors or omissions in these materials. MACOM may make changes to specifications and product descriptions at any time, without notice. MACOM makes no commitment to update the information and shall have no responsibility whatsoever for conflicts or incompatibilities arising from future changes to its specifications and product descriptions. No license, express or implied, by estoppel or otherwise, to any intellectual property rights is granted by this document.

THESE MATERIALS ARE PROVIDED "AS IS" WITHOUT WARRANTY OF ANY KIND, EITHER EXPRESS OR IMPLIED, RELATING TO SALE AND/OR USE OF MACOM PRODUCTS INCLUDING LIABILITY OR WARRANTIES RELATING TO FITNESS FOR A PARTICULAR PURPOSE, CONSEQUENTIAL OR INCIDENTAL DAMAGES, MERCHANTABILITY, OR INFRINGEMENT OF ANY PATENT, COPYRIGHT OR OTHER INTELLECTUAL PROPERTY RIGHT. MACOM FURTHER DOES NOT WARRANT THE ACCURACY OR COMPLETENESS OF THE INFORMATION, TEXT, GRAPHICS OR OTHER ITEMS CONTAINED WITHIN THESE MATERIALS. MACOM SHALL NOT BE LIABLE FOR ANY SPECIAL, INDIRECT, INCIDENTAL, OR CONSEQUENTIAL DAMAGES, INCLUDING WITHOUT LIMITATION, LOST REVENUES OR LOST PROFITS, WHICH MAY RESULT FROM THE USE OF THESE MATERIALS.

MACOM products are not intended for use in medical, lifesaving or life sustaining applications. MACOM customers using or selling MACOM products for use in such applications do so at their own risk and agree to fully indemnify MACOM for any damages resulting from such improper use or sale.

Компания «Океан Электроники» предлагает заключение долгосрочных отношений при поставках импортных электронных компонентов на взаимовыгодных условиях!

Наши преимущества:

- Поставка оригинальных импортных электронных компонентов напрямую с производств Америки, Европы и Азии, а так же с крупнейших складов мира;
- Широкая линейка поставок активных и пассивных импортных электронных компонентов (более 30 млн. наименований);
- Поставка сложных, дефицитных, либо снятых с производства позиций;
- Оперативные сроки поставки под заказ (от 5 рабочих дней);
- Экспресс доставка в любую точку России;
- Помощь Конструкторского Отдела и консультации квалифицированных инженеров;
- Техническая поддержка проекта, помощь в подборе аналогов, поставка прототипов;
- Поставка электронных компонентов под контролем ВП;
- Система менеджмента качества сертифицирована по Международному стандарту ISO 9001;
- При необходимости вся продукция военного и аэрокосмического назначения проходит испытания и сертификацию в лаборатории (по согласованию с заказчиком);
- Поставка специализированных компонентов военного и аэрокосмического уровня качества (Xilinx, Altera, Analog Devices, Intersil, Interpoint, Microsemi, Actel, Aeroflex, Peregrine, VPT, Syfer, Eurofarad, Texas Instruments, MS Kennedy, Miteq, Cobham, E2V, MA-COM, Hittite, Mini-Circuits, General Dynamics и др.);

Компания «Океан Электроники» является официальным дистрибьютором и эксклюзивным представителем в России одного из крупнейших производителей разъемов военного и аэрокосмического назначения «JONHON», а так же официальным дистрибьютором и эксклюзивным представителем в России производителя высокотехнологичных и надежных решений для передачи СВЧ сигналов «FORSTAR».



JONHON

«JONHON» (основан в 1970 г.)

Разъемы специального, военного и аэрокосмического назначения:

(Применяются в военной, авиационной, аэрокосмической, морской, железнодорожной, горно- и нефтедобывающей отраслях промышленности)

«FORSTAR» (основан в 1998 г.)

ВЧ соединители, коаксиальные кабели,
кабельные сборки и микроволновые компоненты:

(Применяются в телекоммуникациях гражданского и специального назначения, в средствах связи, РЛС, а так же военной, авиационной и аэрокосмической отраслях промышленности).



Телефон: 8 (812) 309-75-97 (многоканальный)

Факс: 8 (812) 320-03-32

Электронная почта: ocean@oceanchips.ru

Web: <http://oceanchips.ru/>

Адрес: 198099, г. Санкт-Петербург, ул. Калинина, д. 2, корп. 4, лит. А